



## EAO Product Information

Series 22





Description .....	3
Product Assembly .....	4
Devices raised mounting .....	5
Accessories.....	9
Technical Data.....	13
Marking .....	14
Drawings.....	15
Index.....	19

## Product Information

### General notes

The illuminated pushbuttons, keylock switches, mushroom pushbuttons with momentary or maintained action and indicators are primarily noteworthy for their degree of protection IP 65 of the front (i.e. dust and splash-proof). Their robust, compact design, mounting by one man, their screw and plug-in terminals proof against inadvertent contact, and their large surface area for engraving and illumination are other quality features.

The switching element is a double-break snap-action system, the current being carried by a through-contact bar.

The dimensions of the front bezel are 24 x 36 mm. For indicators and illuminated pushbuttons you can choose the design of the front to suit your requirements from two front bezels which clip on in different ways. The raised front bezel of keylock switches is fixed Typ-Nr. 02-967.0.

### Mounting

Mounting by one man from the front. The switch, pushed into the square opening in the panel from the front, can be fixed with two clamping elements (tighten screws with max. 30 Ncm).

### Lenses

The flat lenses, made of Polymethyl Methacrylate, are obtainable in various colours, as well as transparent or translucent.

The lens has to be fitted in the unactuated position.

### Marking

For further information about engraving, hot stamping and film inserts see part Marking.

### Illumination

The T1 <sup>3</sup>/<sub>4</sub> Midget Groove incandescent (filament) lamp (6 ... 48 V) ensures perfect illumination of the lenses, which are supplied in various colours.

T1 <sup>3</sup>/<sub>4</sub> Midget Groove Single-LED (6, 12, 24, 28, 48 V) are also available in blue, green, red, white or yellow.

Luminosity and wave length scattering caused by the technology used in the LED manufacturing processes may lead to visual differences in our products.

For supply voltages above 48 V, it is necessary to use a voltage reduction element (external series resistor or transformer).

### Position indication

The status of a maintained action switch can be determined by the position of the lens.

### Keylock switch

Standard lock (Index D). Standard lock number is 311. If the lock number is not specified, we will supply standard number 311.

An additional 134 special locks (Index X) are available on request.

Master keys for lock numbers 311 ... 445 may be ordered by quoting Typ-Nr. 31-989.300. Two keys are supplied with each keylock switch.

Spare keys (Index D) for standard locks may be ordered by quoting Typ-Nr. 31-989.xxx (please state the lock number).

### Number structure

Nomenclature in accordance with ' IEC 61058 TEST REPORT '. The certification document we dispatch to them on demands.

## Specimen order

### Indicator :

- Indicator actuator, 24 x 36 mm, screw terminal 22-040.004

### Essential accessories :

- Lens plastic red, transparent 22-903.2
- Front bezel flush, black 22-965.0
- Single-LED, T1 <sup>3</sup>/<sub>4</sub> MG, 24 VAC/DC, red 10-2J12.1062

*We reserve the right to modify technical data*

*All dimensions in mm*

## Pushbutton illuminative, raised mounting

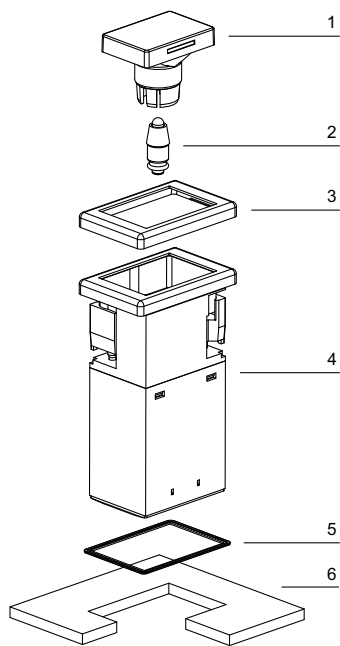



- 1 Lens
- 2 LED
- 3 Front bezel clip-on
- 4 Switch housing
- 5 Sealing
- 6 Front plate

## Indicator actuator



### Essential Accessories:

-  Front bezel flush page 9
-  Lens plastic page 9
-  Single-LED page 11

	Front protection	Terminals	□ 24 x 36 mm Typ-Nr.	Mounting dimensions	Technical drawing	Circuit drawing	
<b>Indicator actuator</b>	IP 65	PT 6.3	<b>22-040.004</b>	1	2	1	0.019
		ST	<b>22-040.001</b>	1	2	1	0.022



Terminals: PT 6.3 = Plug-in terminal 6.3 mm, ST = Screw terminal

Mounting dimensions from page 15, Technical drawing from page 15, Circuit drawing from page 16

## Illuminated pushbutton actuator



### Essential Accessories:

-  Front bezel flush page 9
-  Lens plastic page 9
-  Single-LED page 11

	Front protection	Switching system	Contacts	Switching action	Terminals	□ 24 x 36 mm Typ-Nr.	Mounting dimensions	Technical drawing	Circuit drawing		
<b>Illuminated pushbutton actuator</b>	IP 65	SA	1 NC	MA	PT 6.3	<b>22-222.014</b>	1	6	3	0.032	
					ST	<b>22-222.011</b>	1	3	3	0.037	
				M	PT 6.3	<b>22-212.014</b>	1	3	8	0.032	
					ST	<b>22-212.011</b>	1	3	8	0.037	
				1 NC + 1 NO	MA	PT 6.3	<b>22-225.014</b>	1	3	5	0.034
						ST	<b>22-225.011</b>	1	3	5	0.044
			M		PT 6.3	<b>22-215.014</b>	1	3	10	0.034	
					ST	<b>22-215.011</b>	1	3	10	0.044	
			1 NO	MA	PT 6.3	<b>22-221.014</b>	1	3	4	0.032	
					ST	<b>22-221.011</b>	1	3	4	0.037	
				M	PT 6.3	<b>22-211.014</b>	1	3	9	0.032	
					ST	<b>22-211.011</b>	1	3	9	0.037	
			2 NC	MA	PT 6.3	<b>22-224.014</b>	1	3	2	0.034	
					ST	<b>22-224.011</b>	1	3	2	0.044	
				M	PT 6.3	<b>22-214.014</b>	1	3	7	0.034	
					ST	<b>22-214.011</b>	1	3	7	0.044	
			2 NO	MA	PT 6.3	<b>22-223.014</b>	1	3	6	0.044	
					ST	<b>22-223.011</b>	1	3	6	0.044	
				M	PT 6.3	<b>22-213.014</b>	1	3	11	0.034	
					ST	<b>22-213.011</b>	1	3	11	0.044	

Switching system: SA = Snap-action switching element

Contacts: NC = Normally closed, NO = Normally open

Switching action: MA = Maintained action, M = Momentary action

Terminals: PT 6.3 = Plug-in terminal 6.3 mm, ST = Screw terminal



Mounting dimensions from page 15, Technical drawing from page 15, Circuit drawing from page 16



## Mushroom-head pushbutton actuator



### Essential Accessories:

-  Front bezel flush page 9
-  Mushroom-head cap page 9

	Switching system	Contacts	Switching action	Terminals	□ 24 x 36 mm Typ-Nr.	Mounting dimensions			
						Technical drawing	Circuit drawing		
<b>Mushroom-head pushbutton actuator</b>	SA	1 NC	MA	PT 6.3	<b>22-222.014</b>	1	4	3	0.032
				ST	<b>22-222.011</b>	1	4	3	0.037
			M	PT 6.3	<b>22-212.014</b>	1	4	8	0.032
				ST	<b>22-212.011</b>	1	4	8	0.037
		1 NC + 1 NO	MA	PT 6.3	<b>22-225.014</b>	1	4	5	0.034
				ST	<b>22-225.011</b>	1	4	5	0.044
			M	PT 6.3	<b>22-215.014</b>	1	4	10	0.034
				ST	<b>22-215.011</b>	1	4	10	0.044
		1 NO	MA	PT 6.3	<b>22-221.014</b>	1	4	4	0.032
				ST	<b>22-221.011</b>	1	4	4	0.037
			M	PT 6.3	<b>22-211.014</b>	1	4	9	0.032
				ST	<b>22-211.011</b>	1	4	9	0.037
		2 NC	MA	PT 6.3	<b>22-224.014</b>	1	4	2	0.034
				ST	<b>22-224.011</b>	1	4	2	0.044
			M	PT 6.3	<b>22-214.014</b>	1	4	7	0.034
				ST	<b>22-214.011</b>	1	4	7	0.044
		2 NO	MA	PT 6.3	<b>22-223.014</b>	1	4	6	0.044
				ST	<b>22-223.011</b>	1	4	6	0.044
			M	PT 6.3	<b>22-213.014</b>	1	4	11	0.034
				ST	<b>22-213.011</b>	1	4	11	0.044

Switching system: SA = Snap-action switching element

Contacts: NC = Normally closed, NO = Normally open

Switching action: MA = Maintained action, M = Momentary action

Terminals: PT 6.3 = Plug-in terminal 6.3 mm, ST = Screw terminal

Mounting dimensions from page 15, Technical drawing from page 15, Circuit drawing from page 16

## Keylock switch 2 positions

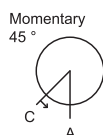
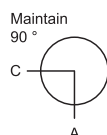

	Front protection	Switching system	Contacts	Switching action	Terminals	Key remove	□ 24 x 36 mm Typ-Nr.	Mounting dimensions	Technical drawing	Circuit drawing	(%)	
<b>Keylock switch 2 positions</b> Position A : Basic position Position C : Maintained action Standard lock 311 Front : Plastic black	IP 65	SA	1 NC + 1 NO	MA	PT 6.3	A	<b>22-335.114D</b>	1	5	16	0.046	
						C	<b>22-335.314D</b>	1	5	16	0.046	
						C + A	<b>22-335.514D</b>	1	5	16	0.046	
					ST	A	<b>22-335.111D</b>	1	5	16	0.051	
						C	<b>22-335.311D</b>	1	5	16	0.051	
						C + A	<b>22-335.511D</b>	1	5	16	0.051	
				1 NO	MA	PT 6.3	A	<b>22-331.114D</b>	1	5	15	0.046
							C	<b>22-331.314D</b>	1	5	15	0.044
							C + A	<b>22-331.514D</b>	1	5	15	0.040
			ST		A	<b>22-331.111D</b>	1	5	15	0.051		
					C	<b>22-331.311D</b>	1	5	15	0.044		
					C + A	<b>22-331.511D</b>	1	5	15	0.044		
			2 NO	MA	PT 6.3	A	<b>22-333.114D</b>	1	5	17	0.046	
						C	<b>22-333.314D</b>	1	5	17	0.046	
						C + A	<b>22-333.514D</b>	1	5	17	0.046	
ST	A	<b>22-333.111D</b>		1	5	17	0.051					
	C	<b>22-333.311D</b>		1	5	17	0.051					
	C + A	<b>22-333.511D</b>		1	5	17	0.051					
Position A : Basic position Position C : Momentary action Standard lock 311 Front : Plastic black	IP 65	SA	1 NC + 1 NO	M	PT 6.3	A	<b>22-355.114D</b>	1	5	13	0.046	
					ST	A	<b>22-355.111D</b>	1	5	13	0.051	
				1 NO	M	PT 6.3	A	<b>22-351.114D</b>	1	5	12	0.046
			ST			A	<b>22-351.111D</b>	1	5	12	0.051	
			2 NO	M	PT 6.3	A	<b>22-353.114D</b>	1	5	14	0.046	
						ST	A	<b>22-353.111D</b>	1	5	14	0.051

Other lock numbers on request

Switching system: SA = Snap-action switching element

Contacts: NC = Normally closed, NO = Normally open

Switching action: MA = Maintained action, M = Momentary action

Terminals: PT 6.3 = Plug-in terminal 6.3 mm, ST = Screw terminal

Mounting dimensions from page 15, Technical drawing from page 15, Circuit drawing from page 16

## Front

### Lens plastic

	Lens	□ 24 x 36 mm Typ-Nr.	
<b>Lens plastic</b> illuminative	blue transparent	<b>22-903.6</b>	0.003
	colourless transparent	<b>22-903.7</b>	0.003
	green transparent	<b>22-903.5</b>	0.003
	orange transparent	<b>22-903.3</b>	0.003
	red transparent	<b>22-903.2</b>	0.003
	smoked transparent	<b>22-903.1</b>	0.003
	yellow transparent	<b>22-903.4</b>	0.003
illuminative (not recommended for film insert)	colourless transparent	<b>22-905.7</b>	0.003
	green transparent	<b>22-905.5</b>	0.003
	red transparent	<b>22-905.2</b>	0.003
illuminative (not recommended for film insert, bright LED's are visible)	yellow transparent	<b>22-905.4</b>	0.003
	blue translucent	<b>22-901.6</b>	0.003
	green translucent	<b>22-901.5</b>	0.003
	orange translucent	<b>22-901.3</b>	0.003
	red translucent	<b>22-901.2</b>	0.003
non-illuminative	white translucent	<b>22-901.9</b>	0.003
	yellow translucent	<b>22-901.4</b>	0.003
	black opaque	<b>22-901.0</b>	0.003
	grey opaque	<b>22-901.8</b>	0.003



### Mushroom-head cap

use Front bezel flush

	Mushroom had cap	□ 24 x 36 mm Typ-Nr.	
<b>Mushroom-head cap</b> non-illuminative	Plastic black opaque	<b>22-930.0</b>	0.006
	Plastic green opaque	<b>22-930.5</b>	0.006
	Plastic red opaque	<b>22-930.2</b>	0.006
	Plastic yellow opaque	<b>22-930.4</b>	0.006



### Front bezel flush

	Front bezel	□ 24 x 36 mm Typ-Nr.	
<b>Front bezel flush</b>	Plastic black	<b>02-965.0</b>	0.001



### Front bezel raised

Lens only removable with lens remover 98-969

	Front bezel	□ 24 x 36 mm Typ-Nr.	
<b>Front bezel raised</b>	Plastic black	<b>02-967.0</b>	0.001



## Protective cover

use Front bezel flush

		Technical drawing	
	$\varnothing$ 24 x 36 mm Typ-Nr.		
<b>Protective cover</b> hinged, transparent, with means for sealing	<b>22-925</b>	1	0.004

Technical drawing from page 15

## Blind plug

		$\varnothing$ 24 x 36 mm Typ-Nr.	
	Blind plug Plastic black		
<b>Blind plug</b> Mounting hole size 16 mm dia.		<b>22-949.0</b>	0.005

## Master key

	Typ-Nr.	
		
<b>Master key</b> Lock numbers 311 ... 445 (DOM)	<b>31-989.300</b>	0.006

## Spare key

	Typ-Nr.	
		
<b>Spare key</b> Key lock switch, standard lock 311 (DOM)	<b>31-989.311</b>	0.006

Other lock numbers on request

## Illumination

### Filament lamp

	Socket	Operating voltage/-current	Typ-Nr.	
<b>Filament lamp</b>	T1 3/4 MG	12 VAC/DC, 75 mA	<b>10-1309.1309</b>	0.001
		14 VAC/DC, 80 mA	<b>10-1310.1319</b>	0.001
		18 VAC/DC, 40 mA	<b>10-1311.1249</b>	0.001
		24 VAC/DC, 35 mA	<b>10-1312.1229</b>	0.001
		28 VAC/DC, 30 mA	<b>10-1313.1209</b>	0.001
		28 VAC/DC, 40 mA	<b>10-1313.1249</b>	0.001
		36 VAC/DC, 20 mA	<b>10-1316.1179</b>	0.001
		36 VAC/DC, 30 mA	<b>10-1316.1209</b>	0.001
		48 VAC/DC, 20 mA	<b>10-1319.1179</b>	0.001
		48 VAC/DC, 25 mA	<b>10-1319.1199</b>	0.001
		6 VAC/DC, 120 mA	<b>10-1306.1349</b>	0.001
		6.3 VAC/DC, 200 mA	<b>10-1307.1369</b>	0.001



### Single-LED

	Socket	Light colour	Operating voltage/-current	Typ-Nr.	
<b>Single-LED</b>	T1 3/4 MG	blue	12 VAC/DC, 7/14 mA	<b>10-2J09.1066</b>	0.002
			24 VAC/DC, 7/14 mA	<b>10-2J12.1066</b>	0.002
			28 VAC/DC, 7/14 mA	<b>10-2J13.1066</b>	0.002
			48 VAC/DC, 4/8 mA	<b>10-2J19.1046</b>	0.002
			6 VDC, 15 mA	<b>10-2J06.3146</b>	0.002
		green	12 VAC/DC, 4/7 mA	<b>10-2J09.1065</b>	0.002
			24 VAC/DC, 4/7 mA	<b>10-2J12.1065</b>	0.002
			28 VAC/DC, 4/7 mA	<b>10-2J13.1065</b>	0.002
			48 VAC/DC, 2/4 mA	<b>10-2J19.1045</b>	0.002
			6 VDC, 7 mA	<b>10-2J06.3145</b>	0.002
		red	12 VAC/DC, 7/14 mA	<b>10-2J09.1062</b>	0.002
			24 VAC/DC, 7/14 mA	<b>10-2J12.1062</b>	0.002
			28 VAC/DC, 7/14 mA	<b>10-2J13.1062</b>	0.002
			48 VAC/DC, 4/8 mA	<b>10-2J19.1042</b>	0.002
			6 VDC, 15 mA	<b>10-2J06.3142</b>	0.002
		white diffuse	12 VAC/DC, 7/14 mA	<b>10-2J09.1069</b>	0.002
			24 VAC/DC, 7/14 mA	<b>10-2J12.1069</b>	0.002
			28 VAC/DC, 7/14 mA	<b>10-2J13.1069</b>	0.002
			48 VAC/DC, 4/8 mA	<b>10-2J19.1049</b>	0.002
			6 VDC, 15 mA	<b>10-2J06.3149</b>	0.002
		yellow	12 VAC/DC, 7/14 mA	<b>10-2J09.1064</b>	0.002
			24 VAC/DC, 7/14 mA	<b>10-2J12.1064</b>	0.002
			28 VAC/DC, 7/14 mA	<b>10-2J13.1064</b>	0.002
			48 VAC/DC, 4/8 mA	<b>10-2J19.1044</b>	0.002
			6 VDC, 15 mA	<b>10-2J06.3144</b>	0.002



Note:  
AC operation through halve-wave rectifier possible, slight flickering can occur.

## Series resistor

for lamp voltage reduction

	Operation voltage	Typ-Nr.	
<b>Series resistor</b> 10 kΩ, for filament lamp 48 VAC, 25 mA	230/240 V	<b>02-904.7</b>	0.003
2.7 kΩ, for filament lamp 48 VAC, 25 mA	110 V	<b>02-904.0</b>	0.003
3.3 kΩ, for filament lamp 48 VAC, 25 mA	125 V	<b>02-904.1</b>	0.003
4.7 kΩ, for filament lamp 48 VAC, 25 mA	145 V	<b>02-904.3</b>	0.003



Please keep to the country specific security rules.

## Terminal plate empty

for fitting with series resistors

	Typ-Nr.	
<b>Terminal plate empty</b> 10 spaces 125 x 60 x 15 mm	<b>02-912.2</b>	0.045
15 spaces 187.5 x 60 x 15 mm	<b>02-912.3</b>	0.090
20 spaces 250 x 60 x 15 mm	<b>02-912.4</b>	0.095
5 spaces 62.5 x 60 x 15 mm	<b>02-912.1</b>	0.025



## Assembling

### Lens remover

	Typ-Nr.	
<b>Lens remover</b> for flush front bezel	<b>02-905</b>	0.011
for raised front bezel	<b>98-968</b>	0.004



### Lamp remover

	Typ-Nr.	
<b>Lamp remover</b>	<b>61-9740.0</b>	0.003



CAUTION

A switching process might be released when replacing the lamp/LED !

## Dismantling tool

for dismantling the lens from the holder

	Typ-Nr.	
<b>Dismantling tool</b>	<b>22-938</b>	0.030



## Actuator with snap-action switching element

### Switching system

Self-cleaning, double-break, snap-action switching system (with contact gap 2 x 1.5 mm).  
Max. 2 normally closed or 2 normally open contacts, or one of each.

### Material

#### Lens

Polymethylmethacrylate PMMA, as per UL 94 HB, Polycarbonate (PC), as per UL 94 V0

#### Front bezel

Polyphenylenoxide (PPO)

#### Material of contact

Hard silver

#### Actuator housing

Polyamide (PA), Polytherimide (PEI)

### Mechanical characteristics

#### Terminals

Screw terminal (with self-lifting clip):  
Max. wire cross-section 2 x 2.5 mm<sup>2</sup>  
Max. wire cross-section of stranded cable 2 x 1.5 mm<sup>2</sup>

Plug-in terminal 6.3 x 0.8 mm

#### Actuating force

with 1 switching element 3.6 N ±0.3 N  
with 2 switching elements 6.8 N ±0.3 N

#### Actuating travel

5.5 mm ±0.2 mm

#### Travel

3 mm

#### Rebound time

≤3 ms

#### Mechanical lifetime

Illuminated pushbutton 1 million operations  
Keylock switch 40 000 operations

### Electrical characteristics

#### Contact resistance

Starting value ≤50 mΩ, as per IEC 60512-2-4

#### Isolation resistance

≥100M Ω between all contacts at 100 VDC, as per IEC 60512-2-10

#### Switch rating

Power rating  
min. 12 VAC, 50 mA  
max. 400 VAC, 10 A

Switch rating AC (cosφ 0,7), service category AC-11

Voltage	125 VAC	250 VAC	380 VAC
Current	8 A	5 A	3 A
Operations	≥100 000		

Switch rating DC (inductive) L:R = 30 ms, service categorie DC-11

Voltage	24 V	60 V	110 V	220 V
Current	6 A	1.5 A	0.4 A	0.2 A
Operations	≥100 000			

#### Electric strength

2500 VAC, 50 Hz, 1 min. between all terminals and earth, as per IEC 60512-2-11.

### Environmental conditions

#### Storage temperature

-40 °C ... +95 °C

#### Service temperature

-25 °C ... +85 °C

#### Protection degree

Terminal/case IP 20  
Front IP 65 as per IEC 60529

#### Shock resistance

50 g for 11 ms, as per IEC 60512-4-3

#### Vibration resistance

(sinusoidal)  
10 g at 10 Hz ... 2000 Hz, amplitude 0.75 mm, as per IEC 60512-4-4

### Approvals

#### Approbations

CB (IEC 61058)  
CSA  
ENEC (EN 61058)  
UL  
VDE

#### Declaration of conformity

CE  
RoHS

## General notes

### 1. Engraving

In addition to the most commonly used world languages, in DIN 1451-3 close spacing, other typefaces are available as Scandinavian, Slavic, Greek, Russian and Polish.

Red, blue and black lenses are filled with white colour. Other colour lenses are filled in black. Standard height of letters is 3 mm. If the height is not specified, we will supply 3 mm engraved letters.

### 2. Hot stamping

For larger series it is worth considering markings by means of hot stamping. We will be pleased to advise you.

For letters and figures, typefaces with 2.5 mm, 3 mm and 4 mm are available.

### 3. Film inserts

Instead of using engraving the lenses can be fitted with transparent film inserts, as an alternative. For this purpose, though, it is advisable to use transparent lenses.

In the case of use of a smoke-black lens the fitted film becomes readable only if the lamp is on.

The film thickness is 0.2 mm.

**Important** : Consider pushbutton mounting orientation before specifying engraving characters !

All dimensions in mm

Film insert max. size	Height of letters h	Number of lines	Number of (target value) capital letters per line	Number of (target value) small letters per line	Image
14.3 x 22.4	3	4	11	13	B1
			7 - 8	8 - 9	B2
	4	2	7	9	B1
			4	5	B2
	5	2	5 - 6	6 - 7	B1
			3	3 - 4	B2
	6	1	5	6	B1
			2	3	B2
	8	1	3	4	B1
			2	2	B2

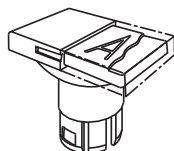
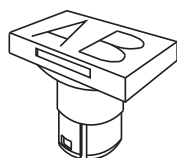

B1

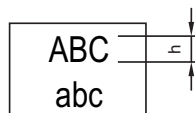

B2

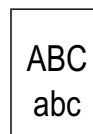



## Mounting dimensions

1 Indicator actuator page 5 | Illuminated pushbutton actuator page 6 | Mushroom-head pushbutton actuator page 7 | Keylock switch 2 positions page 8

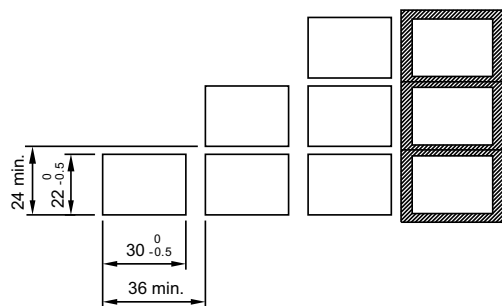

## Technical drawing

1 Protective cover page 10

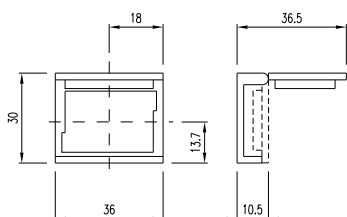

2 Indicator actuator page 5

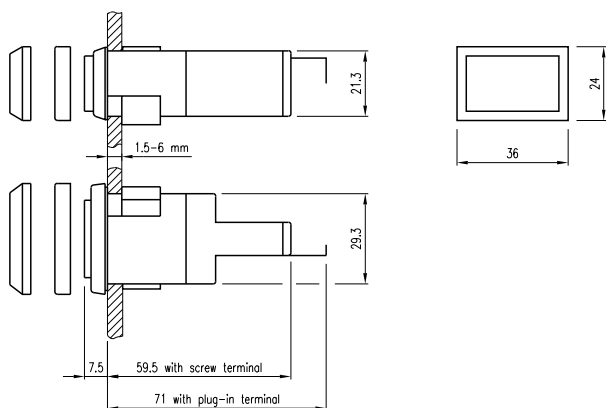

3 Illuminated pushbutton actuator page 6

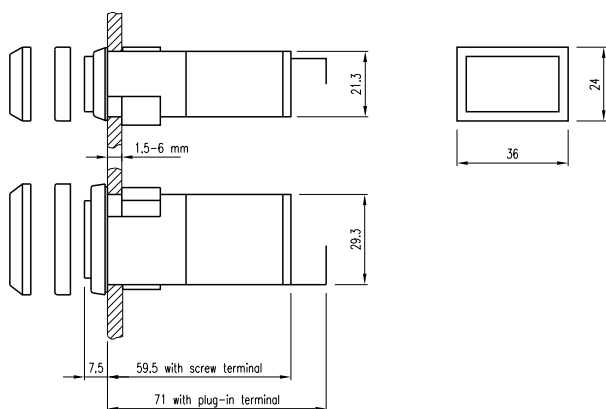

## 4 Mushroom-head pushbutton actuator page 7

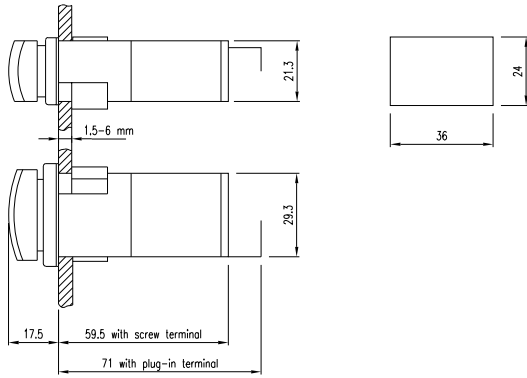

## 5 Keylock switch 2 positions page 8

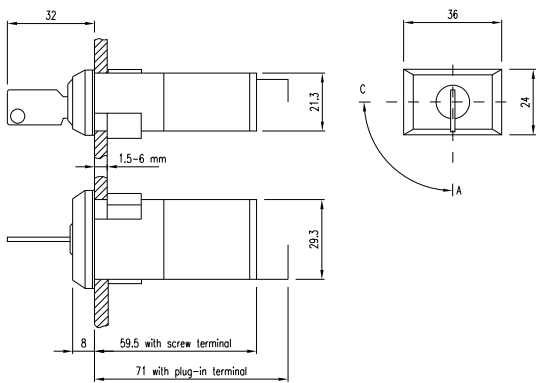

## 6 Illuminated pushbutton actuator page 6

### Circuit drawing

#### 1 Indicator actuator page 5



#### 2 Illuminated pushbutton actuator page 6 | Mushroom-head pushbutton actuator page 7

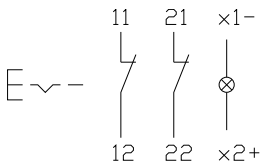

#### 3 Illuminated pushbutton actuator page 6 | Mushroom-head pushbutton actuator page 7

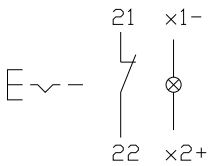

**4 Illuminated pushbutton actuator page 6 | Mushroom-head pushbutton actuator page 7**

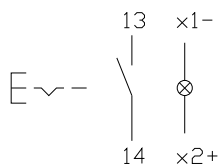

**5 Illuminated pushbutton actuator page 6 | Mushroom-head pushbutton actuator page 7**

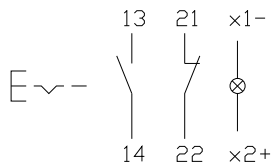

**6 Illuminated pushbutton actuator page 6 | Mushroom-head pushbutton actuator page 7**

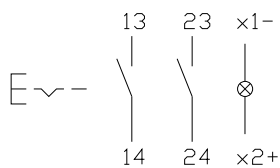

**7 Illuminated pushbutton actuator page 6 | Mushroom-head pushbutton actuator page 7**

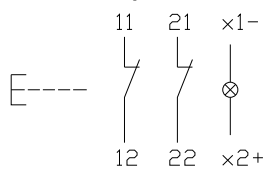

**8 Illuminated pushbutton actuator page 6 | Mushroom-head pushbutton actuator page 7**

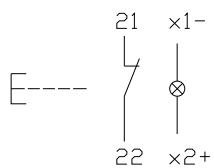

**9 Illuminated pushbutton actuator page 6 | Mushroom-head pushbutton actuator page 7**

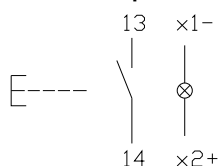

**10 Illuminated pushbutton actuator page 6 | Mushroom-head pushbutton actuator page 7**

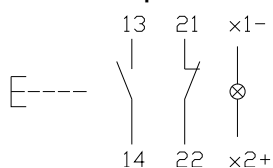

**11 Illuminated pushbutton actuator page 6 | Mushroom-head pushbutton actuator page 7**

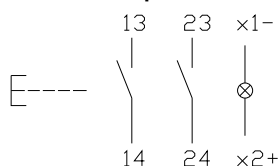

12 Keylock switch 2 positions page 8



13 Keylock switch 2 positions page 8

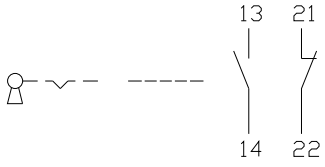

14 Keylock switch 2 positions page 8

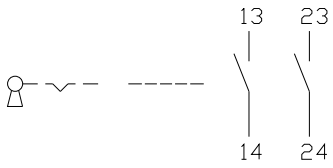

15 Keylock switch 2 positions page 8

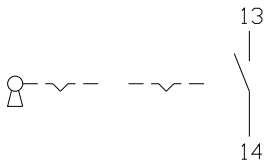

16 Keylock switch 2 positions page 8

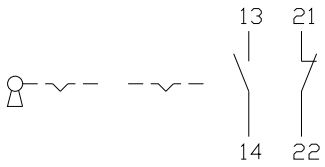

17 Keylock switch 2 positions page 8

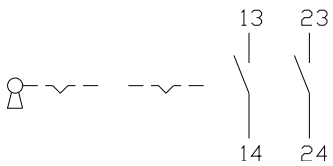

# Index from Typ-Nr.

Typ-Nr.	Page	Typ-Nr.	Page	Typ-Nr.	Page
02-904.0	12	22-214.011	7	22-903.5	9
02-904.1	12	22-214.014	6	22-903.6	9
02-904.3	12	22-214.014	7	22-903.7	9
02-904.7	12	22-215.011	6	22-905.2	9
02-905	12	22-215.011	7	22-905.4	9
02-912.1	12	22-215.014	6	22-905.5	9
02-912.2	12	22-215.014	7	22-905.7	9
02-912.3	12	22-221.011	6	22-925	10
02-912.4	12	22-221.011	7	22-930.0	9
02-965.0	9	22-221.014	6	22-930.2	9
02-967.0	9	22-221.014	7	22-930.4	9
10-1306.1349	11	22-222.011	6	22-930.5	9
10-1307.1369	11	22-222.011	7	22-938	12
10-1309.1309	11	22-222.014	6	22-949.0	10
10-1310.1319	11	22-222.014	7	31-989.300	10
10-1311.1249	11	22-223.011	6	31-989.311	10
10-1312.1229	11	22-223.011	7	61-9740.0	12
10-1313.1209	11	22-223.014	6	98-968	12
10-1313.1249	11	22-223.014	7		
10-1316.1179	11	22-224.011	6		
10-1316.1209	11	22-224.011	7		
10-1319.1179	11	22-224.014	6		
10-1319.1199	11	22-224.014	7		
10-2J06.3142	11	22-225.011	6		
10-2J06.3144	11	22-225.011	7		
10-2J06.3145	11	22-225.014	6		
10-2J06.3146	11	22-225.014	7		
10-2J06.3149	11	22-331.111D	8		
10-2J09.1062	11	22-331.114D	8		
10-2J09.1064	11	22-331.311D	8		
10-2J09.1065	11	22-331.314D	8		
10-2J09.1066	11	22-331.511D	8		
10-2J09.1069	11	22-331.514D	8		
10-2J12.1062	11	22-333.111D	8		
10-2J12.1064	11	22-333.114D	8		
10-2J12.1065	11	22-333.311D	8		
10-2J12.1066	11	22-333.314D	8		
10-2J12.1069	11	22-333.511D	8		
10-2J13.1062	11	22-333.514D	8		
10-2J13.1064	11	22-335.111D	8		
10-2J13.1065	11	22-335.114D	8		
10-2J13.1066	11	22-335.311D	8		
10-2J13.1069	11	22-335.314D	8		
10-2J19.1042	11	22-335.511D	8		
10-2J19.1044	11	22-335.514D	8		
10-2J19.1045	11	22-351.111D	8		
10-2J19.1046	11	22-351.114D	8		
10-2J19.1049	11	22-353.111D	8		
22-040.001	5	22-353.114D	8		
22-040.004	5	22-355.111D	8		
22-211.011	6	22-355.114D	8		
22-211.011	7	22-901.0	9		
22-211.014	6	22-901.2	9		
22-211.014	7	22-901.3	9		
22-212.011	6	22-901.4	9		
22-212.011	7	22-901.5	9		
22-212.014	6	22-901.6	9		
22-212.014	7	22-901.8	9		
22-213.011	6	22-901.9	9		
22-213.011	7	22-903.1	9		
22-213.014	6	22-903.2	9		
22-213.014	7	22-903.3	9		
22-214.011	6	22-903.4	9		

	<b>EAO AG</b>
	Tannwaldstrasse 88
	4601 Olten, Switzerland
<b>E-mail</b>	info@eao.com
<b>Website</b>	www.eao.com
	<b>Austria</b>
Phone	+49 201 85 87 0
Fax	+49 201 85 87 210
E-mail	sales.ede@eao.com
	<b>Belgium</b>
Phone	+32 3 777 82 36
Fax	+32 3 777 84 19
E-mail	sales.ebl@eao.com
	<b>China</b>
Phone	+852 27 86 91 41
Fax	+852 27 86 95 61
E-mail	sales.ehk@eao.com
	<b>France</b>
Phone	+33 1 64 43 37 37
Fax	+33 1 64 43 37 49
E-mail	sales.esa@eao.com
	<b>Germany</b>
Phone	+49 201 85 87 0
Fax	+49 201 85 87 210
E-mail	sales.ede@eao.com
	<b>Italy</b>
Phone	+39 035 481 0189
Fax	+39 035 481 3786
E-mail	sales.eit@eao.com
	<b>Japan</b>
Phone	+81 3 5401 0953
Fax	+81 3 5444 0345
E-mail	sales.esj@eao.com
	<b>Netherlands</b>
Phone	+31 78 653 17 00
Fax	+31 78 653 17 99
E-mail	sales.enl@eao.com
	<b>Sweden</b>
Phone	+46 8 683 86 60
Fax	+46 8 724 29 12
E-mail	sales.esw@eao.com
	<b>Switzerland</b>
Phone	+41 62 388 95 00
Fax	+41 62 388 95 55
E-mail	sales.ech@eao.com
	<b>United Kingdom</b>
Phone	+44 1444 236 000
Fax	+44 1444 236 641
E-mail	sales.euk@eao.com
	<b>USA</b>
Phone	+1 203 877 4577
Fax	+1 203 877 3694
E-mail	sales.eus@eao.com
	<b>Other Countries</b>
Phone	+41 62 286 92 10
Fax	+41 62 296 21 62
E-mail	info@eao.com

Компания «Life Electronics» занимается поставками электронных компонентов импортного и отечественного производства от производителей и со складов крупных дистрибьюторов Европы, Америки и Азии.

С конца 2013 года компания активно расширяет линейку поставок компонентов по направлению коаксиальный кабель, кварцевые генераторы и конденсаторы (керамические, пленочные, электролитические), за счёт заключения дистрибьюторских договоров

Мы предлагаем:

- Конкурентоспособные цены и скидки постоянным клиентам.
- Специальные условия для постоянных клиентов.
- Подбор аналогов.
- Поставку компонентов в любых объемах, удовлетворяющих вашим потребностям.
- Приемлемые сроки поставки, возможна ускоренная поставка.
- Доставку товара в любую точку России и стран СНГ.
- Комплексную поставку.
- Работу по проектам и поставку образцов.
- Формирование склада под заказчика.
- Сертификаты соответствия на поставляемую продукцию (по желанию клиента).
- Тестирование поставляемой продукции.
- Поставку компонентов, требующих военную и космическую приемку.
- Входной контроль качества.
- Наличие сертификата ISO.

В составе нашей компании организован Конструкторский отдел, призванный помогать разработчикам, и инженерам.

Конструкторский отдел помогает осуществить:

- Регистрацию проекта у производителя компонентов.
- Техническую поддержку проекта.
- Защиту от снятия компонента с производства.
- Оценку стоимости проекта по компонентам.
- Изготовление тестовой платы монтаж и пусконаладочные работы.



Тел: +7 (812) 336 43 04 (многоканальный)

Email: [org@lifeelectronics.ru](mailto:org@lifeelectronics.ru)