

Shuen 3W Series

炫

“Shuen [Xuan] is the English translation for the Chinese word meaning Bright and Shiny. Both words are relevant descriptions of this Everlight LED series. The modern, adaptive Chinese definition of the word represents that which is New, Extravagant, and Highly Sought After.”

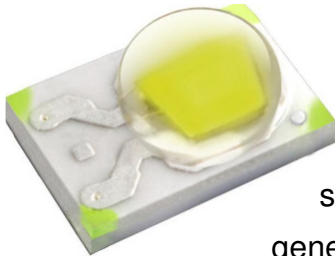

Introduction

The Shuen series is a surface-mount high-power device featuring high brightness combined with a compact size that is suitable for all kinds of lighting applications such as general illumination, flash, spot, signal, industrial and commercial lighting. The thermal pad of this device is electrically isolated providing convenience in thermal and electrical design. The Shuen series is one of the most promising devices in Everlight's high power product offering and is ready to face the challenges of today's Solid-State Lighting requirements.

Features

- ◆ Small package with high efficiency
- ◆ ESD protection up to 8KV
- ◆ Soldering method: SMT
- ◆ Binning Parameters: Brightness, Forward Voltage, Wavelength and Chromaticity
- ◆ Moisture Sensitivity Level: 1
- ◆ RoHS compliant
- ◆ Matches ANSI binning
- ◆ Reliability testing conforms to IESNA LM80 Lumen maintenance test method

Applications

- ◆ General Lighting
- ◆ Decorative and Entertainment Lighting
- ◆ Signal and Symbol Luminaries for orientation marker lights (e.g. steps, exit ways, etc.)
- ◆ Exterior and Interior Automotive Illumination

Table of Contents

Absolute Maximum Ratings	4
JEDEC Moisture Sensitivity	4
PN of the Shuen series: White LEDs	6
PN of the Shuen High Luminous Series: White LEDs	7
White Bin Structure	11
Forward Voltage Bins	16
Color Bins	17
Optical Characteristics	18
Mechanical Dimension	19
Pad Configuration	20
Reflow Soldering Characteristics	21
Wavelength Characteristics.....	22
Typical Light Output Characteristic V.S. Thermal Pad Temperature.....	24
Typical Electrical Characteristics.....	25
Typical Relative Luminous Flux V.S. Forward Current	26
Relative Flux and Forward Voltage V.S. Junction Temperature.....	30
Current Derating Curves	31
Typical Radiation Patterns	32
Emitter Reel Packaging.....	34
Product Labeling	34
Storage Conditions.....	35
Revision History	36

Product Nomenclature

The product name is designated as below:

ELSH – ABCDE – FGHIJ – V1234

Designation:

AB = min. luminous flux (lm) or radiation power (mW) performance

C = radiation pattern ^[1]

D = color ^[2]

E = power consumption ^[3]

F = reserved for future product offerings

G = internal coding

H = packaging type ^[4]

IJ = internal coding

V = forward voltage bin

1234 = color bin or CCT bin

Notes

1. Table of radiation patterns

Symbol	Description
1	Lambertian

2. Table of color offerings:

Symbol	Color	Dominant wavelength range/Peak wavelength/CCT
R	Red	620~635nm
Y	Amber	580~595nm
G	Green	520~550nm
B	Blue	450~470nm
C	Cool-White	4745~7050K
N	Neutral-White	3710~4745K
M	Warm-White	2580~3710K

3. Table of power consumptions:

Symbol	Description
3	3W

4. Table of packaging types:

Symbol	Description
P	Tape

Absolute Maximum Ratings

Parameter	Symbol	Ratings	Unit
Max. DC Forward Current (mA)	I_F	750 ^[1]	mA
Max. Peak Pulse Current (mA)	I_{Pulse}	1000 ^[2]	mA
Max. ESD Resistance	V_B	8000	V
Reverse Voltage	V_R	Note 3	V
Thermal Resistance	R_{th}	6~8 ^[4]	°C/W
Max. Junction Temperature	T_J	125 ^[5]	°C
Operating Temperature	T_{Opr}	-40 ~ +100 ^[6]	°C
Storage Temperature	T_{Stg}	-40 ~ +100	°C
Max. Soldering Temperature	T_{Sol}	260	°C
Allowable Reflow Cycles	n/a	2	cycles

Notes:

1. Maximum forward current for 3W is 750mA (Thermal Pad=25°C).
2. Duty cycle = 1/10@1KHZ
3. The Shuen series LEDs are not designed for reverse bias use.
4. Thermal Resistance is 6°C/W for Blue, Green, Cool-White, Neutral-White, and Warm-White LEDs and 8°C/W for Red, and Amber LEDs.
5. Maximum junction temperature of Cool-White, Neutral-White, Warm-White, Blue, Green, Red, and Amber LEDs is 125°C.
6. Maximum Operating Temperature (Thermal Pad) of Cool-White, Neutral-White, Warm-White, Blue, Green, Red, and Amber LEDs is 100°C.

JEDEC Moisture Sensitivity

Level	Floor Life		Soak Requirements Standard	
	Time (hours)	Conditions	Time (hours)	Conditions
1	unlimited	≤ 30°C / 85% RH	168 (+5/-0)	85°C / 85% RH

Luminous Flux Characteristics for the Shuen series

Color	Part Number	3W	
		Minimum Luminous Flux(lm) or Radiometric Power(mW) ^[1]	Drive Current (mA)
Cool White	ELSH – J51CX	140	700
	ELSH – J61CX	150	700
	ELSH – J71CX	160	700
	ELSH – J81CX	170	700
Neutral White	ELSH – J31NX	120	700
	ELSH – J41NX	130	700
	ELSH – J51NX	140	700
	ELSH – J61NX	150	700
Warm White	ELSH – J21MX	110	700
	ELSH – J31MX	120	700
	ELSH – J41MX	130	700
	ELSH – J51MX	140	700
Red	ELSH – F81RX	80	700
	ELSH – F91RX	90	700
Amber	ELSH – F81YX	80	700
	ELSH – F91YX	90	700
Green	ELSH – F91GX	90	700
	ELSH – J11GX	100	700
Blue	ELSH – E81BX	20	700
	ELSH – E91BX	23	700

Notes:

1. Luminous flux measurement tolerance: ±10%.
2. The data of luminous flux measured at thermal pad=25 °C
3. Typical luminous flux or light output performance is operated within the conditions guided by this datasheet.

PN of the Shuen series: White LEDs

The table below is a list of part numbers for the Everlight Shuen 3W series White LED. All parts listed match ANSI binning standards. Bin offerings of 2700K to 6500K are listed and currently available. CRI is also listed with min 70 to 75. Typical view angle is 120°. These clearly listed binning options allow for proper design and implementation into lighting applications. The Order Codes below are currently available White Shuen LEDs.

For Example: If you order product using P/N **ELSH-J61C3-0LPGS-D5700**, you will get

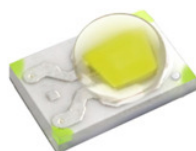

Color Variant	Radiation Pattern	CRI	CCT	Forward Voltage (V)	Minimum Luminous Flux (lm)
Cool White	Lambertian	75	57K-1 ~ 57K-2 ~ 57K-3 ~ 57K-4	3.25~3.55(V2) 3.55~3.85(V3) 3.85~4.15(V4)	150

White, Shuen series LEDs at 700mA are listed below.

Color	Order Code of ELSH	Minimum Luminous Flux (lm)	CCT (K) Wavelength (nm)	Forward Voltage (V)	CRI (min)[1]
Cool White 6500	ELSH-J61C3-0LPGS-D6500	150	65K-1~65K-4	3.25~4.15	70
Cool White 5700	ELSH-J61C3-0LPGS-D5700	150	57K-1~57K-4	3.25~4.15	70
Cool White 5000	ELSH-J51C3-0LPGS-D5000	140	50K-1~50K-4	3.25~4.15	70
Neutral White 4500	ELSH-J41N3-0LPGS-D4500	130	45K-1~45K-4	3.25~4.15	75
Neutral White 4000	ELSH-J31N3-0LPGS-D4000	120	40K-1~40K-4	3.25~4.15	75
Warm White 3500	ELSH-J21M3-0LPGS-D3500	110	35K-1~35K-4	3.25~4.15	75
Warm White 3000	ELSH-J21M3-0LPGS-D3000	110	30K-1~30K-4	3.25~4.15	75
Warm White 2700	ELSH-J21M3-0LPGS-D2700	110	27K-1~27K-4	3.25~4.15	75

Note:

1. CRI measurement tolerance: ± 2 .
2. Each 3W white PN is based on the min. bin, and includes four adjacent bins

PN of the Shuen High Luminous Series: White LEDs

The table below is a list of part numbers for the Everlight Shuen 3W high luminous series White LED. All parts listed match ANSI binning standards. Bin offerings of 2700K to 6500K are listed and currently available. CRI is also listed with min 70 to 80. Typical view angle is 100°. These clearly listed binning options allow for proper design and implementation into lighting applications. The Order Codes below are currently available White Shuen LEDs.

For Example: If you order product using P/N **ELSH-J71C3-0CPGS-D5700**, you will get

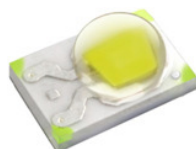

Color Variant	Radiation Pattern	CRI	CCT	Forward Voltage (V)	Minimum Luminous Flux (lm)
Cool White	Lambertian	75	57K-1 ~ 57K-2 ~ 57K-3 ~ 57K-4	2.95~3.25(V1) 3.25~3.55(V2) 3.55~3.85(V3)	160

White ,Shuen series LEDs at 700mA are listed below.

Color	Order Code of ELSH	Minimum Luminous Flux (lm)	CCT (K) Wavelength (nm)	Forward Voltage (V)	CRI (min)
Cool White 6500	ELSH-J71C3-0CPGS-D6500	160	65K-1~65K-4	2.95~3.85	70
	ELSH-J81C3-0CPGS-D6500	180	65K-1~65K-4	2.95~3.85	70
	ELSH-J71C3-0CPHS-D6500	160	65K-1~65K-4	2.95~3.85	80
Cool White 5700	ELSH-J71C3-0CPGS-D5700	160	57K-1~57K-4	2.95~3.85	70
	ELSH-J81C3-0CPGS-D5700	180	57K-1~57K-4	2.95~3.85	70
	ELSH-J71C3-0CPHS-D5700	160	57K-1~57K-4	2.95~3.85	80
Cool White 5000	ELSH-J61C3-0CPGS-D5000	150	50K-1~50K-4	2.95~3.85	70
	ELSH-J71C3-0CPGS-D5000	160	50K-1~50K-4	2.95~3.85	70
	ELSH-J61C3-0CPHS-D5000	150	50K-1~50K-4	2.95~3.85	80
Neutral White 4500	ELSH-J51N3-0CPGS-D4500	140	45K-1~45K-4	2.95~3.85	75
	ELSH-J61N3-0CPGS-D4500	150	45K-1~45K-4	2.95~3.85	75
	ELSH-J51N3-0CPHS-D4500	140	45K-1~45K-4	2.95~3.85	80
Neutral White 4000	ELSH-J41N3-0CPGS-D4000	130	40K-1~40K-4	2.95~3.85	75
	ELSH-J61N3-0CPGS-D4000	150	40K-1~40K-4	2.95~3.85	75
	ELSH-J51N3-0CPHS-D4000	140	40K-1~40K-4	2.95~3.85	80
Warm White 3500	ELSH-J31M3-0CPGS-D3500	120	35K-1~35K-4	2.95~3.85	75
	ELSH-J51M3-0CPGS-D3500	140	35K-1~35K-4	2.95~3.85	75
	ELSH-J41M3-0CPHS-D3500	130	35K-1~35K-4	2.95~3.85	80

Color	Order Code of ELSH	Minimum Luminous Flux (lm)	CCT (K) Wavelength (nm)	Forward Voltage (V)	CRI (min)
Warm White 3000	ELSH-J31M3-0CPGS-D3000	120	30K-1~30K-4	2.95~3.85	75
	ELSH-J51M3-0CPGS-D3000	140	30K-1~30K-4	2.95~3.85	75
	ELSH-J21M3-0CPHS-D3000	110	30K-1~30K-4	2.95~3.85	80
	ELSH-J41M3-0CPHS-D3000	130	30K-1~30K-4	2.95~3.85	80
Warm White 2700	ELSH-J31M3-0CPGS-D2700	120	27K-1~27K-4	2.95~3.85	75
	ELSH-J51M3-0CPGS-D2700	140	27K-1~27K-4	2.95~3.85	75
	ELSH-J21M3-0CPHS-D2700	110	27K-1~27K-4	2.95~3.85	80
	ELSH-J41M3-0CPHS-D2700	130	27K-1~27K-4	2.95~3.85	80

Notes:

1. CRI measurement tolerance: ± 2
2. Each 3W white PN is based on the min. bin, and includes four adjacent bins

PN of the Shuen series: Color LEDs

The table below is a list of part numbers for the Everlight Shuen series Color LED. Standard Everlight color bins are listed according to wavelength and represent the standard primary colors of the spectrum. Typical view angle is 120°. These clearly listed binning options allow for proper design and implementation into lighting applications.

For Example: If you order product using P/N **ELSH-F81R3-0LPNM-BR4R6**, you will get

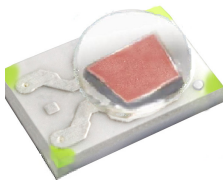

Color Variant	Radiation Pattern	Dominant Wavelength (nm)	Forward Voltage (V)	Minimum Luminous Flux (lm)
Red	Lambertian	615~620(R4) 620~625(R5) 625~630(R6)	2.05~2.35(U2) 2.35~2.65(U3) 2.65~2.95(U4) 2.95~3.25(V1)	80

Color, Shuen series LEDs at 700mA are listed below.

Color	Order Code of ELSH	Minimum Luminous Flux (lm)	Dominant Wavelength (nm)	Forward Voltage(V)
Red	ELSH-F81R3-0LPNM-BR4R6	80	615~630	2.05~3.25
	ELSH-F91R3-0LPNM-BR4R6	90	615~630	2.05~3.25
Amber	ELSH-F81Y3-0LPNM-BA3A5	80	585~592.5	2.05~3.25
	ELSH-F91Y3-0LPNM-BA3A5	90	585~592.5	2.05~3.25
Green	*ELSH-F91G3-0LPNM-DG1G3	90	520~535	3.25~4.15
	*ELSH-J11G3-0LPNM-DG1G3	100	520~535	3.25~4.15
Blue	*ELSH-E81B3-0LPNM-DB6B8	20	455~470	3.25~4.15
	*ELSH-E91B3-0LPNM-DB6B8	23	455~470	3.25~4.15

*Product lead time of at least 8 weeks.

Note:

1. Each 3W direct color PN is based on the min. bin and includes four adjacent bins.

Product Binning

Luminous Flux Bins

Group	Bin	Minimum Photometric Flux (lm)	Maximum Photometric Flux (lm)
E	1	4	5
	2	5	6
	3	6	8
	4	8	10
	5	10	13
	6	13	17
	7	17	20
	8	20	23
	9	23	27
F	1	27	33
	2	33	39
	3	39	45
	4	45	52
	5	52	60
	6	60	70
	7	70	80
	8	80	90
	9	90	100

Group	Bin	Minimum Photometric Flux (lm)	Maximum Photometric Flux (lm)
J	1	100	110
	2	110	120
	3	120	130
	4	130	140
	5	140	150
	6	150	160
	7	160	180
	8	180	200
	9	200	225
K	1	225	250
	2	250	275
	3	275	300
	4	300	325
	5	325	350
	6	350	375
	7	375	400
	8	400	425
	9	425	450
N	1	450	475
	2	475	500
	3	500	525
	4	525	550

White Bin Structure

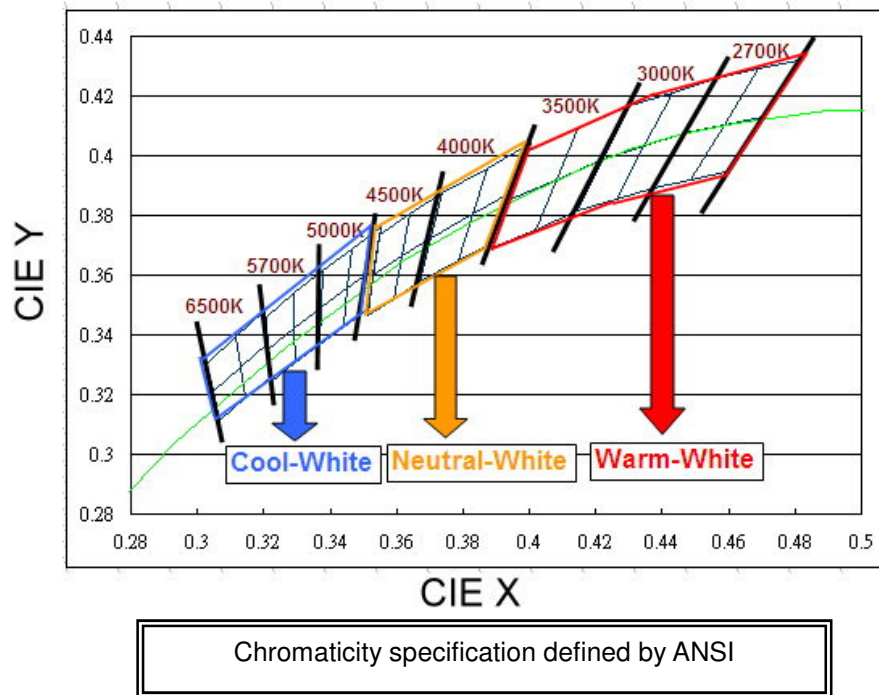

Notes:

1. The CCT range of Cool-White varies from 4745K to 7050K.
2. The CCT range of Neutral-White varies from 3710K to 4745K.
3. The CCT range of Warm-White varies from 2580K to 3710K
4. Color coordinates measurement allowance : ± 0.01
5. Color bins are defined at $I_f=700\text{mA}$ operation.

Cool-White Bin Structure

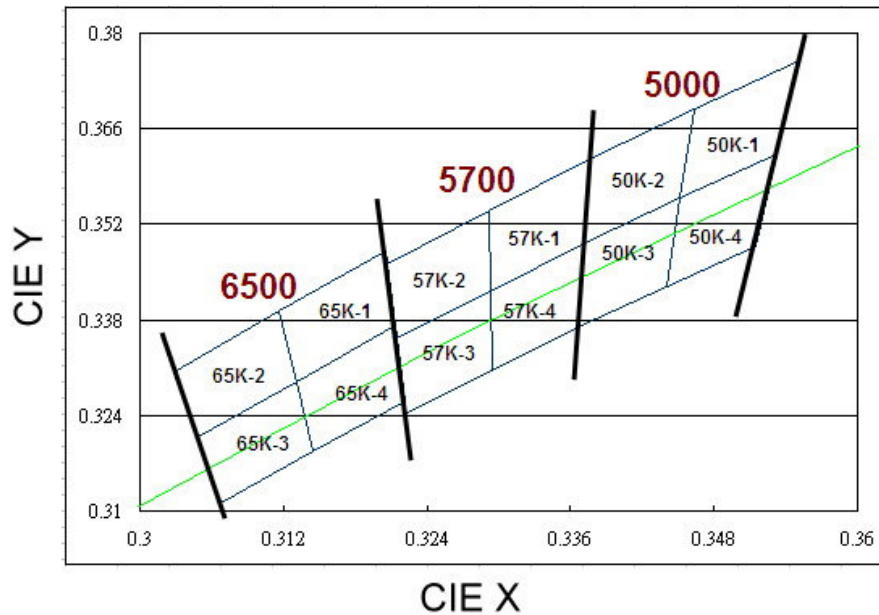

Cool-White Bin Coordinates

5000K

Bin	CIE X	CIE Y
50K-1	0.346	0.369
	0.345	0.356
	0.353	0.362
	0.355	0.376
Reference Range: 4745~5000K		

Bin	CIE X	CIE Y
50K-2	0.338	0.362
	0.337	0.349
	0.345	0.356
	0.346	0.369
Reference Range: 5000~5310K		

Bin	CIE X	CIE Y
50K-4	0.345	0.356
	0.344	0.343
	0.352	0.349
	0.353	0.362
Reference Range: 4745~5000K		

Bin	CIE X	CIE Y
50K-3	0.337	0.349
	0.337	0.337
	0.344	0.343
	0.345	0.356
Reference Range: 5000~5310K		

5700K

Bin	CIE X	CIE Y
57K-1	0.329	0.354
	0.329	0.342
	0.337	0.349
	0.338	0.362
Reference Range: 5310~5700K		

Bin	CIE X	CIE Y
57K-2	0.321	0.346
	0.321	0.335
	0.329	0.342
	0.329	0.354
Reference Range: 5700~6020K		

Bin	CIE X	CIE Y
57K-4	0.329	0.342
	0.329	0.331
	0.337	0.337
	0.337	0.349
Reference Range: 5310~5700K		

Bin	CIE X	CIE Y
57K-3	0.321	0.335
	0.322	0.324
	0.329	0.331
	0.329	0.342
Reference Range: 5700~6020K		

6500K

Bin	CIE X	CIE Y
65K-1	0.312	0.339
	0.313	0.329
	0.321	0.337
	0.321	0.348
Reference Range: 6020~6500K		

Bin	CIE X	CIE Y
65K-2	0.303	0.330
	0.305	0.321
	0.313	0.329
	0.312	0.339
Reference Range: 6500~7050K		

Bin	CIE X	CIE Y
65K-4	0.313	0.329
	0.315	0.319
	0.322	0.326
	0.321	0.337
Reference Range: 6020~6500K		

Bin	CIE X	CIE Y
65K-3	0.305	0.321
	0.307	0.311
	0.315	0.319
	0.313	0.329
Reference Range: 6500~7050K		

Neutral-White Bin Structure

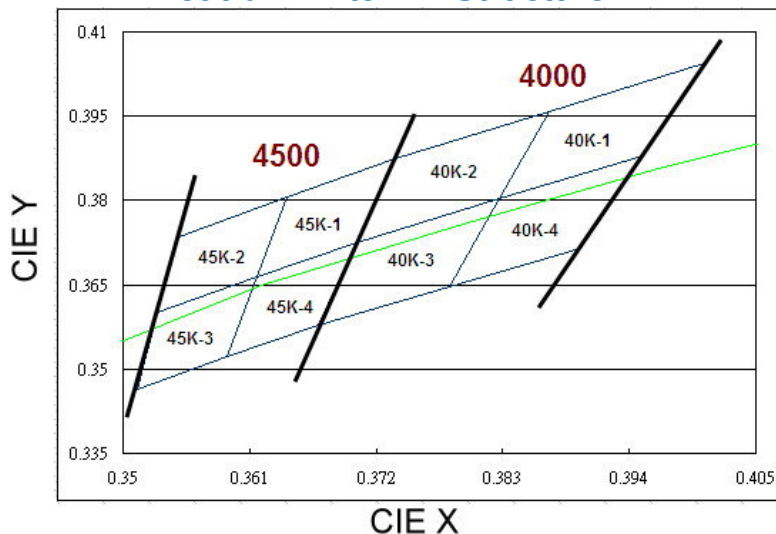

Neutral-White Bin Coordinates

4000K

Bin	CIE X	CIE Y
40K-1	0.387	0.396
	0.383	0.380
	0.395	0.388
	0.401	0.404
Reference Range: 3710~4000K		

Bin	CIE X	CIE Y
40K-2	0.374	0.387
	0.370	0.373
	0.383	0.380
	0.387	0.396
Reference Range: 4000~4260K		

Bin	CIE X	CIE Y
40K-4	0.383	0.380
	0.378	0.365
	0.390	0.372
	0.395	0.388
Reference Range: 3710~4000K		

Bin	CIE X	CIE Y
40K-3	0.370	0.373
	0.367	0.358
	0.378	0.365
	0.383	0.380
Reference Range: 4000~4260K		

4500K

Bin	CIE X	CIE Y
45K-1	0.364	0.381
	0.362	0.366
	0.370	0.373
	0.374	0.387
Reference Range: 4260~4500K		

Bin	CIE X	CIE Y
45K-2	0.355	0.374
	0.353	0.360
	0.362	0.366
	0.364	0.381
Reference Range: 4500~4745K		

Bin	CIE X	CIE Y
45K-4	0.362	0.366
	0.359	0.352
	0.367	0.358
	0.370	0.373
Reference Range: 4260~4500K		

Bin	CIE X	CIE Y
45K-3	0.353	0.360
	0.351	0.347
	0.359	0.352
	0.362	0.366
Reference Range: 4500~4745K		

Warm-White Bin Structure

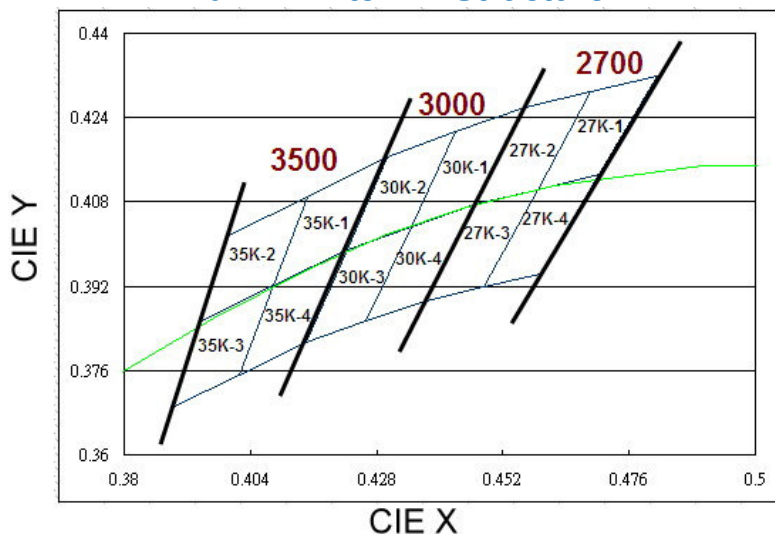

Warm-White Bin Coordinates

2700K

Bin	CIE X	CIE Y
27K-1	0.469	0.429
	0.459	0.410
	0.470	0.413
	0.481	0.432
Reference Range: 2580~2700K		

Bin	CIE X	CIE Y
27K-2	0.456	0.426
	0.447	0.408
	0.459	0.410
	0.469	0.429
Reference Range: 2700~2870K		

Bin	CIE X	CIE Y
27K-4	0.459	0.410
	0.448	0.392
	0.459	0.394
	0.470	0.413
Reference Range: 2580~2700K		

Bin	CIE X	CIE Y
27K-3	0.447	0.408
	0.437	0.389
	0.448	0.392
	0.459	0.410
Reference Range: 2700~2870K		

3000K

Bin	CIE X	CIE Y
30K-1	0.443	0.421
	0.435	0.403
	0.447	0.408
	0.456	0.426
Reference Range: 2870~3000K		

Bin	CIE X	CIE Y
30K-2	0.430	0.417
	0.422	0.399
	0.435	0.403
	0.443	0.421
Reference Range: 3000~3220K		

Bin	CIE X	CIE Y
30K-4	0.435	0.403
	0.426	0.385
	0.437	0.389
	0.447	0.408
Reference Range: 2870~3000K		

Bin	CIE X	CIE Y
30K-3	0.422	0.399
	0.415	0.381
	0.426	0.385
	0.435	0.403
Reference Range: 3000~3220K		

3500K

Bin	CIE X	CIE Y
35K-1	0.415	0.409
	0.408	0.392
	0.422	0.399
	0.430	0.417
Reference Range: 3220~3500K		

Bin	CIE X	CIE Y
35K-2	0.400	0.402
	0.394	0.385
	0.408	0.392
	0.415	0.409
Reference Range: 3500~3710K		

Bin	CIE X	CIE Y
35K-4	0.408	0.392
	0.402	0.375
	0.415	0.381
	0.422	0.399
Reference Range: 3220~3500K		

Bin	CIE X	CIE Y
35K-3	0.394	0.385
	0.389	0.369
	0.402	0.375
	0.408	0.392
Reference Range: 3500~3710K		

Note: Currently available typical CCT ranges are 3000K, 5700K, and 6500K CCT.

Forward Voltage Bins

Group Name	Bins
A	U1+U2+U3+U4
B	U2+U3+U4+V1
C	U4+V1+V2+V3
D	V1+V2+V3+V4
J	U1+U2+U3+U4

Bin	Minimum Forward Voltage (V)	Maximum Forward Voltage (V)
U1	1.75	2.05
U2	2.05	2.35
U3	2.35	2.65
U4	2.65	2.95
V1	2.95	3.25
V2	3.25	3.55
V3	3.55	3.85
V4	3.85	4.15

Notes:

1. Forward voltage measurement tolerance: $\pm 0.1V$.
2. Forward voltage bins are defined at $I_f=700$ mA operation.
3. Other Forward Voltage bins for White LEDs available upon request. Please contact your local Everlight sales office.

Color Bins

Group	Bin	Minimum Dominant / Peak Wavelength (nm)	Maximum Dominant / Peak Wavelength (nm)
B (Blue)	1	430	435
	2	435	440
	3	440	445
	4	445	450
	5	450	455
	6	455	460
	7	460	465
	8	465	470
G (Green)	1	520	525
	2	525	530
	3	530	535
	4	535	540
	5	540	545
	6	545	550
A (Amber)	1	580	582.5
	2	582.5	585
	3	585	587.5
	4	587.5	590
	5	590	592.5
	6	592.5	595
R (Red)	3	610	615
	4	615	620
	5	620	625
	6	625	630
	7	630	635

Notes:

1. Dominant / Peak wavelength measurement tolerance: ± 1 nm.
2. Dominant / Peak wavelength bins are defined at $I_f=700$ mA operation.

Optical Characteristics

Color	Part Number	Part Number Dominant Wavelength λ_D Peak Wavelength λ_P Color Temperature CCT			Typical Temperature Coefficient of Dominant Wavelength (nm/°C)-($\Delta\lambda_D/\Delta T_J$)	Typical Viewing Angle (degrees) $2\theta_{1/2}$
		Min.	Typ.	Max.		
Cool-White	ELSH – XX1CX	4745K	5700K	7050K	---	Note 5
Neutral-White	ELSH – XX1NX	3710K	4260K	4745K	---	Note 5
Warm-White	ELSH – XX1MX	2580K	3000K	3710K	---	Note 5
Red	ELSH – XX1RX	620nm	---	630nm	0.05	120
Orange	ELSH – XX1OX	610nm	---	620nm	0.08	120
Amber	ELSH – XX1YX	585nm	---	595nm	0.1	120
Green	ELSH – XX1GX	520nm	---	535nm	0.05	120
Blue	ELSH – XX1BX	460nm	---	470nm	0.05	120

Notes:

1. The test tolerance of Everlight is ± 1 nm for dominant wavelength, $\pm 5\%$ for CCT.
2. Viewing angle is the width of half the light output intensity in all directions of 180° .
3. All Cool-White, Neutral-White, Warm-White, and dominant wavelength below 550nm LEDs are made with Indium Gallium Nitride (InGaN).
4. All LEDs with dominant wavelength exceeding 550nm are made with Aluminum Indium Gallium Phosphide (AlInGaP).
5. Typical view angle of ELSH-XX1X1-0C and ELSH-XX1X1-0V series is 100° . Typical view angle of ELSH-XX1X1-0L series is 120° .

Mechanical Dimension

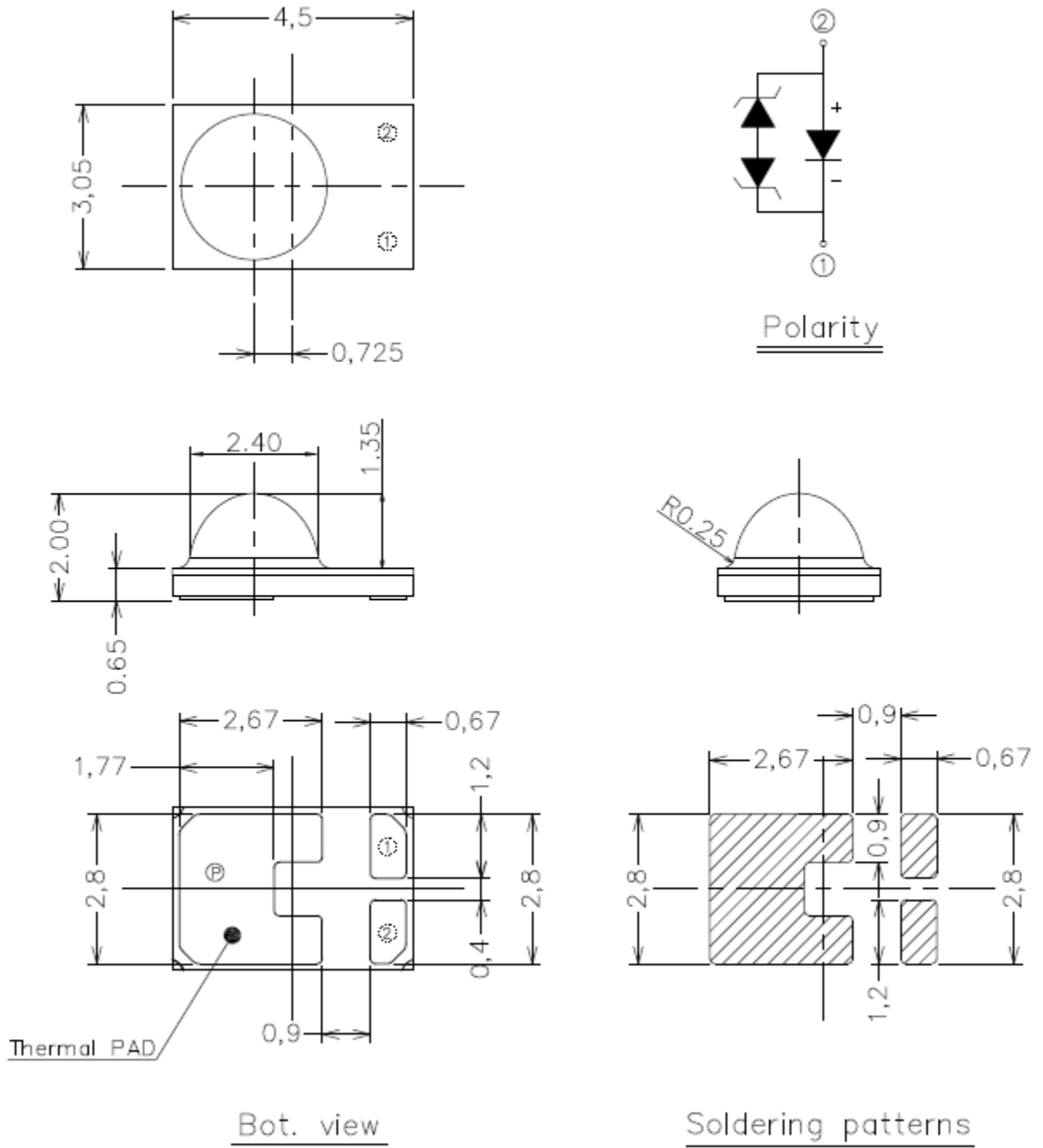

Note:

1. Dimensions are in millimeters.
2. Tolerances unless mentioned are $\pm 0.15\text{mm}$.
3. The thermal pad is electrically isolated from the Anode and Cathode contact pads.
4. Do not handle the device by the lens. Incorrect force applied to the lens may lead to the failure of devices.

Pad Configuration

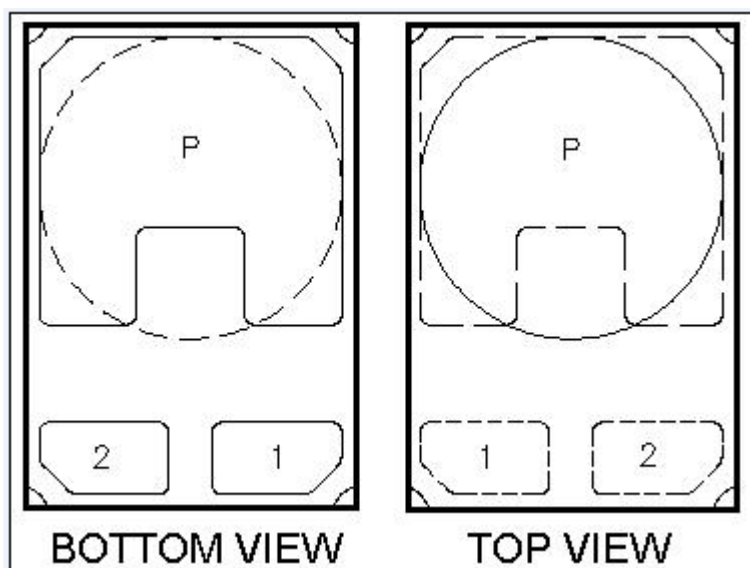

PAD	FUNCTION
1	CATHODE
2	ANODE
P	THERMAL PAD

Reflow Soldering Characteristics

For Reflow Process

- a. ELSH series are suitable for SMT processes.
- b. Curing of glue in oven must be according to standard operation flow processes.

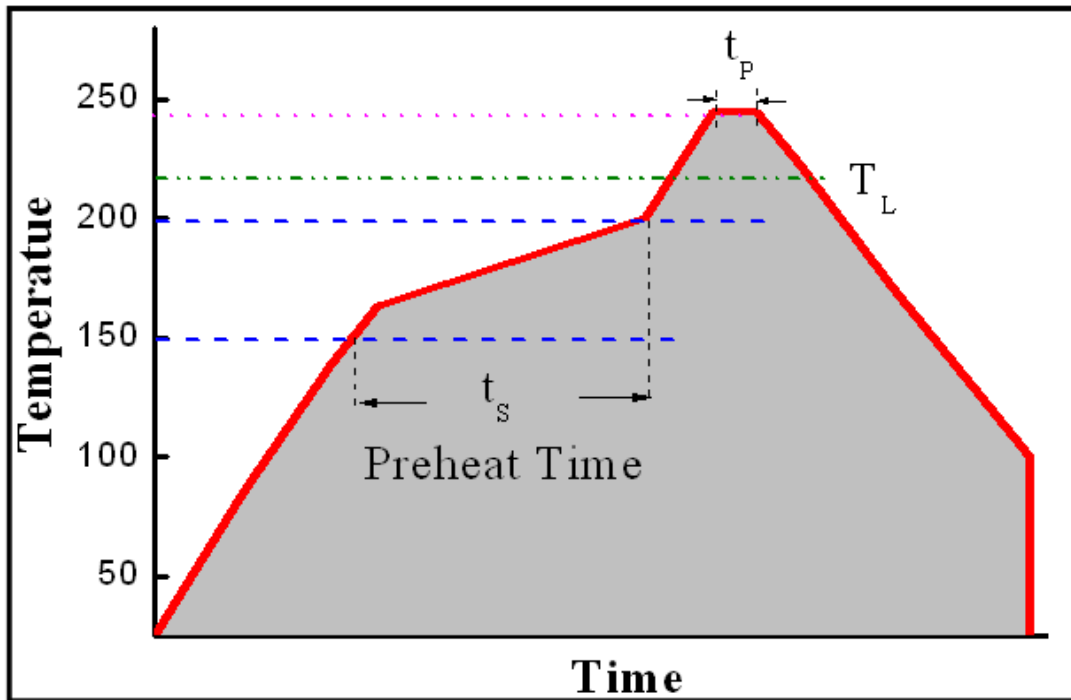

Profile Feature	Lead Free Assembly
Ramp-Up Rate	2-3 °C/S
Preheat Temperature	150-200 °C
Preheat Time (t_s)	60-120 S
Liquid Temperature (T_L)	217 °C
Time maintained above T_L	60-90 S
Peak Temperature (T_P)	240±5 °C
Peak Time (t_P)	Max 20 S
Ramp-Down Rate	3-5 °C/S

- c. Reflow soldering should not be done more than twice.
- d. In soldering process, stress on the LEDs during heating should be avoided.
- e. After soldering, do not bend the circuit board.

Wavelength Characteristics

For Deep-Red, Red, Amber, Yellow, Green, Cyan, Blue, Royal-Blue

@ Thermal Pad Temperature = 25°C

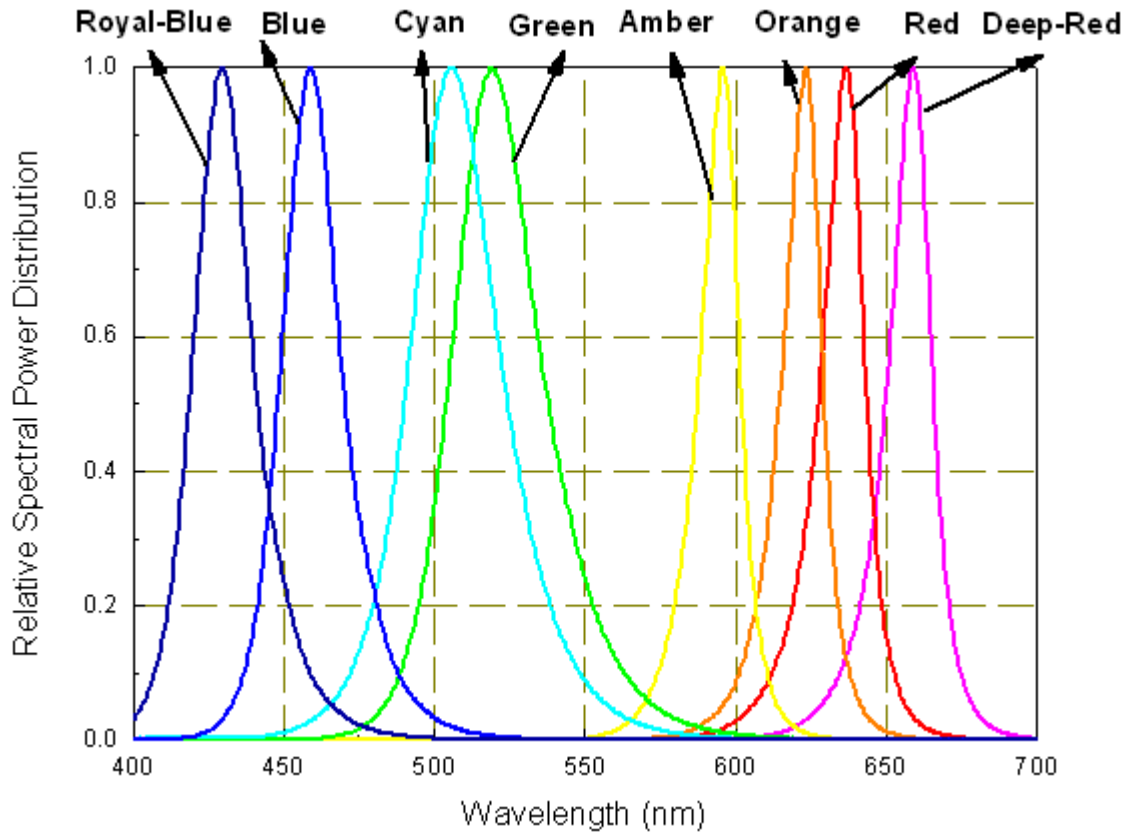

For Cool-White, @ Thermal Pad Temperature = 25°C

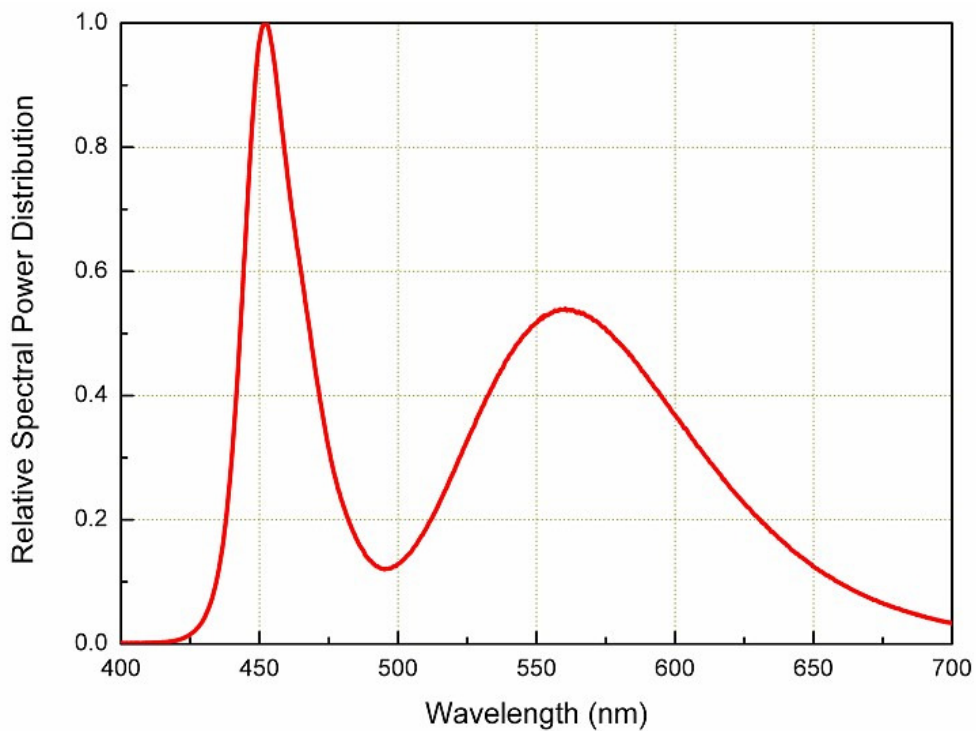

For Neutral-White, @ Thermal Pad Temperature = 25°C

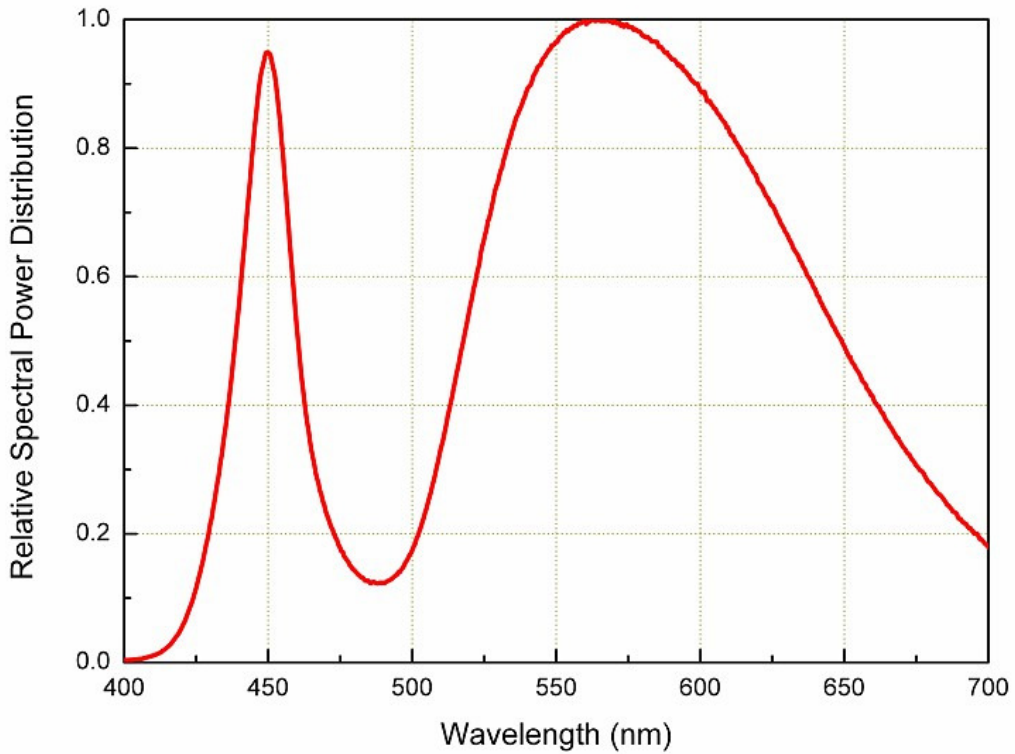

For Warm-White, @ Thermal Pad Temperature = 25°C

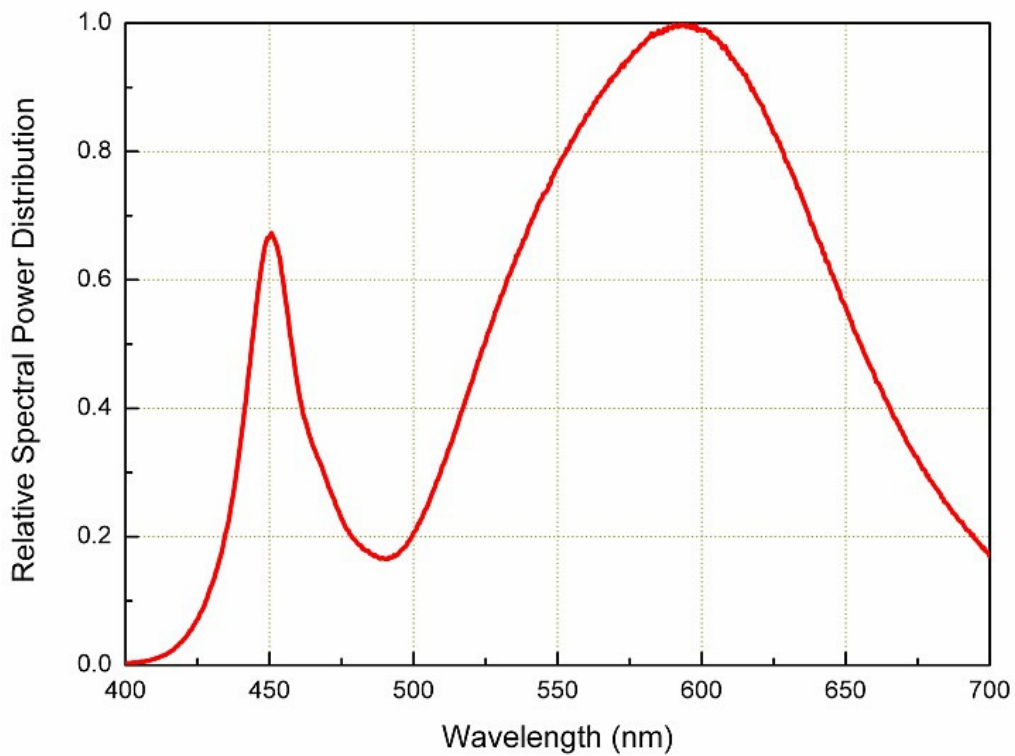

Typical Light Output Characteristic V.S. Thermal Pad Temperature

Cool-White, Neutral-White, Warm-White, for 700mA Drive Current

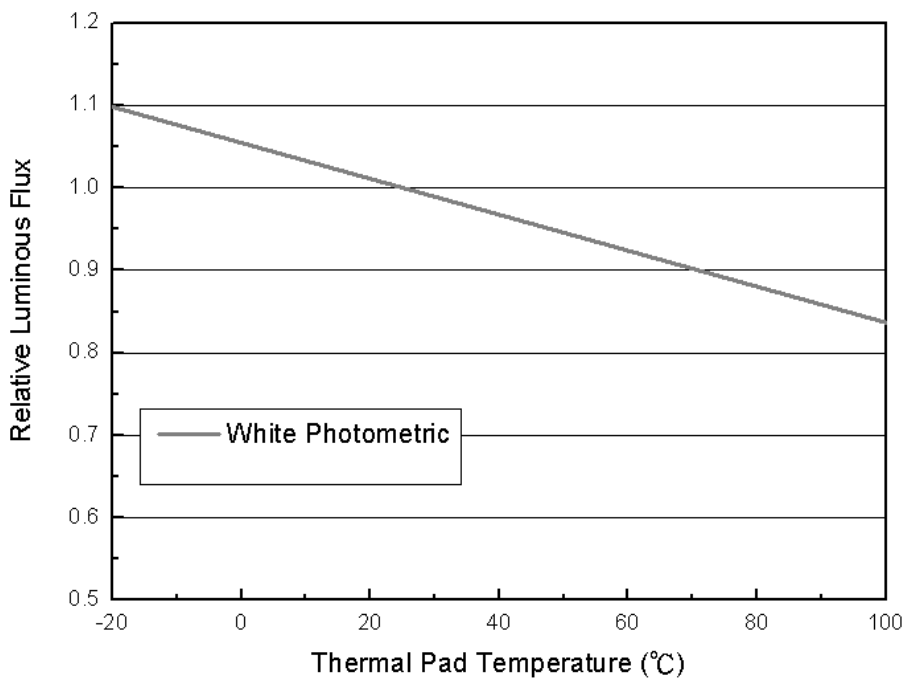

Typical Electrical Characteristics

For Cool-White, Neutral-White, Warm-White, Green, Cyan, Blue, Royal-Blue
@ Thermal Pad Temperature = 25°C

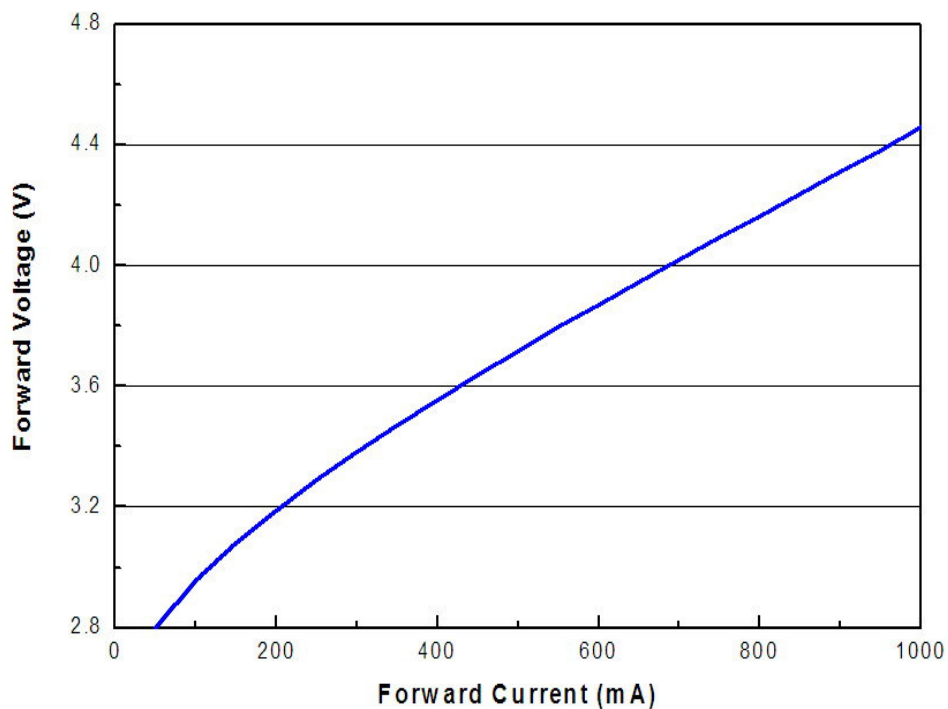

Typical Relative Luminous Flux V.S. Forward Current

For Cool-White, Neutral-White, Warm-White
@ Thermal Pad Temperature = 25°C

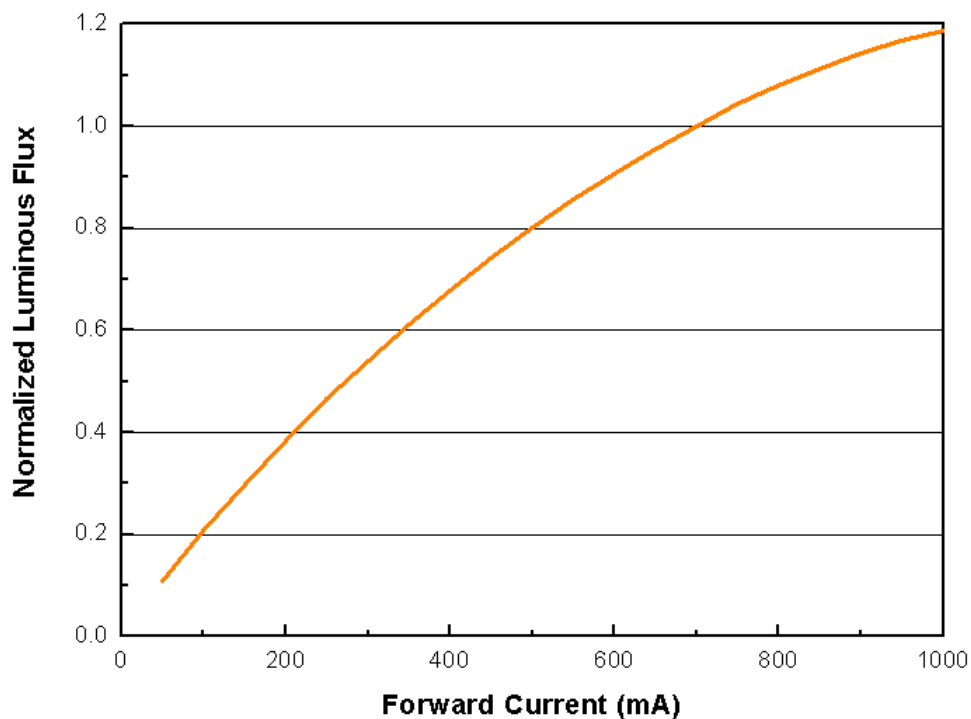

Typical Wavelength & CCT Shift Characteristics V.S. Forward Current

For Cool-White @ Thermal Pad Temperature = 25°C

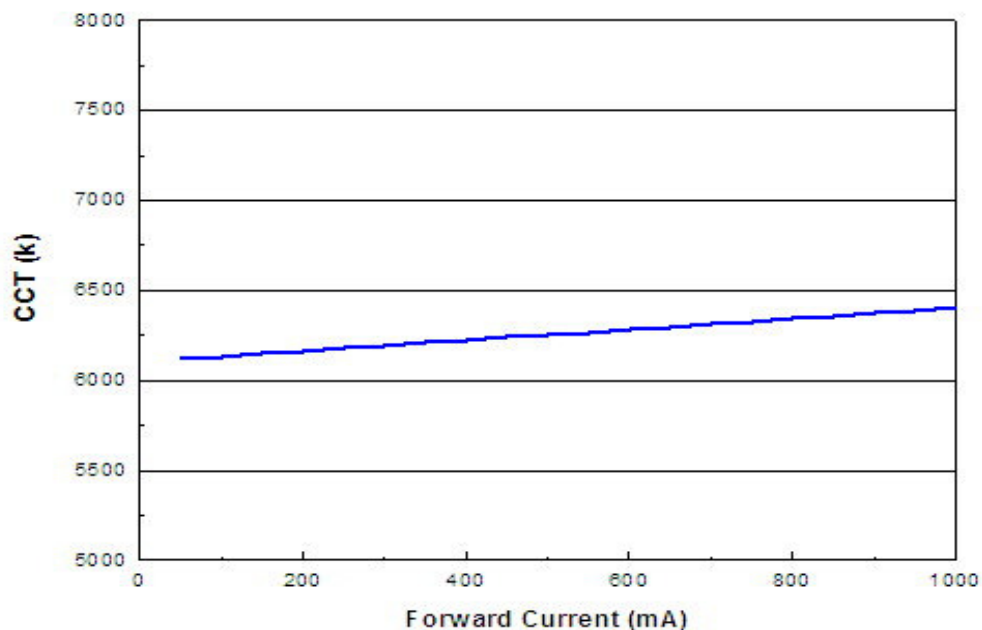

For Neutral-White @ Thermal Pad Temperature = 25°C

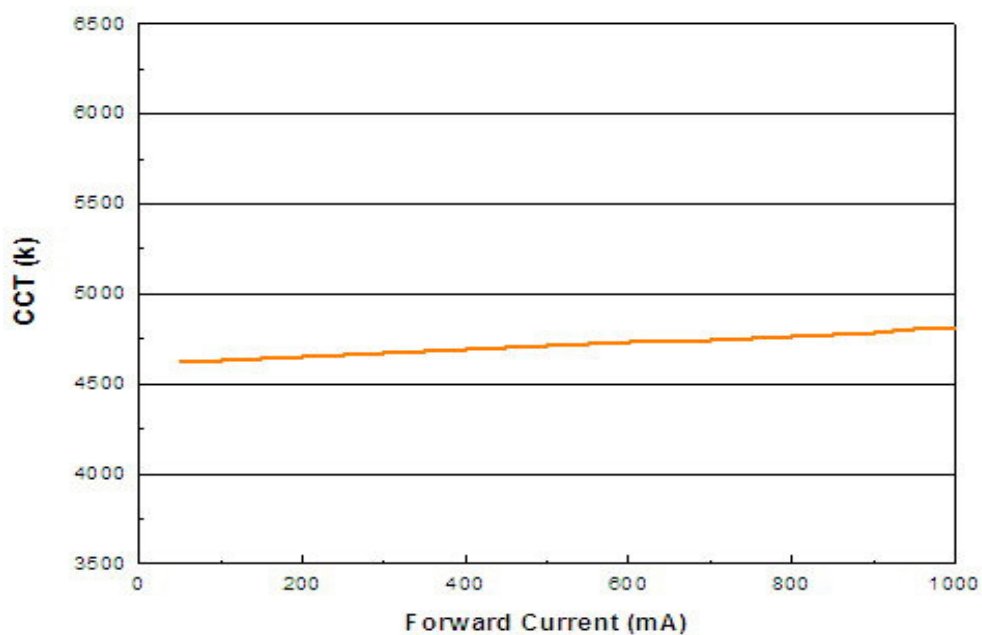

For Warm-White @ Thermal Pad Temperature = 25°C

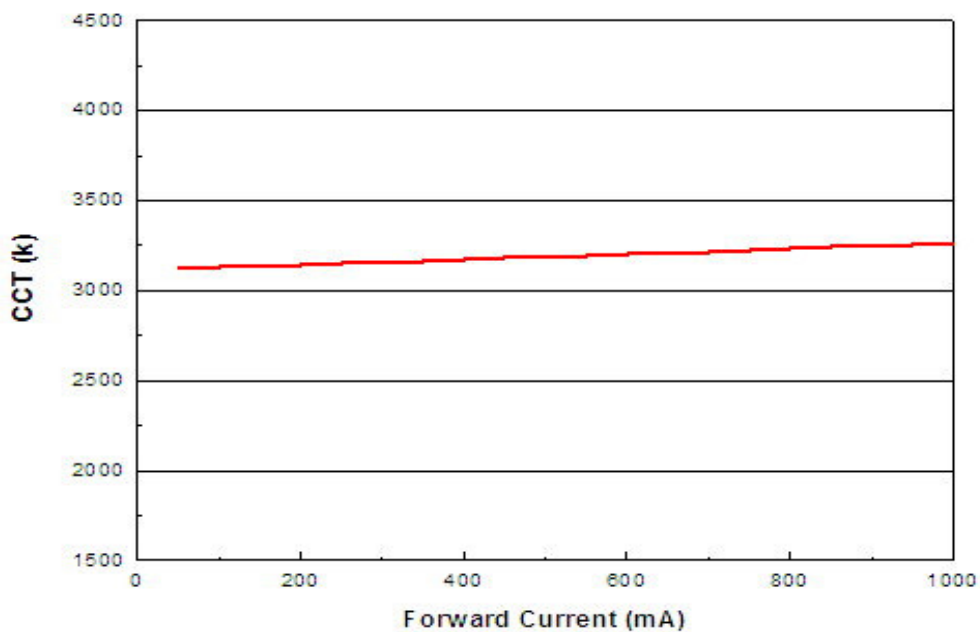

For Blue @ Thermal Pad Temperature = 25°C

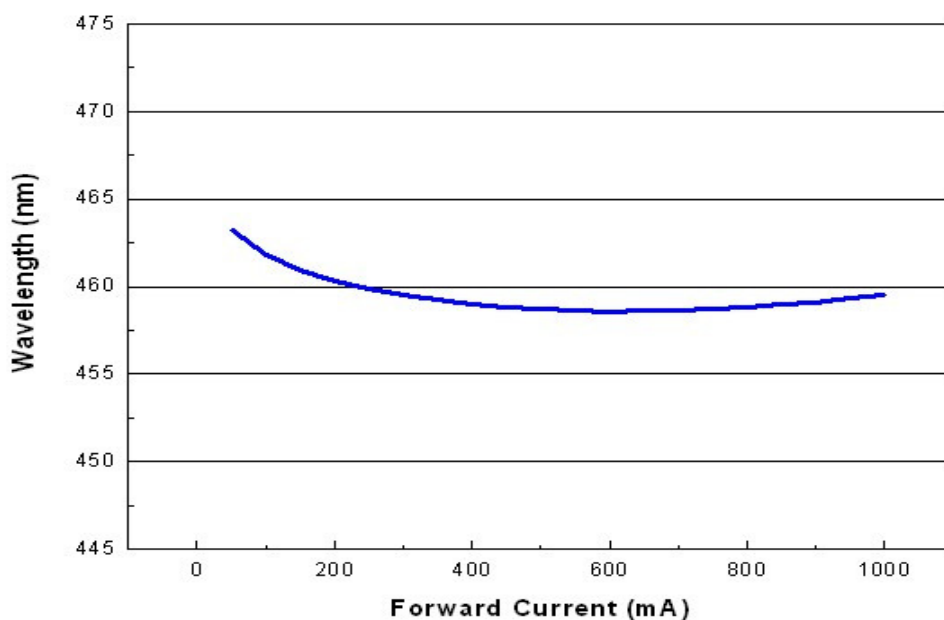

For Green @ Thermal Pad Temperature = 25°C

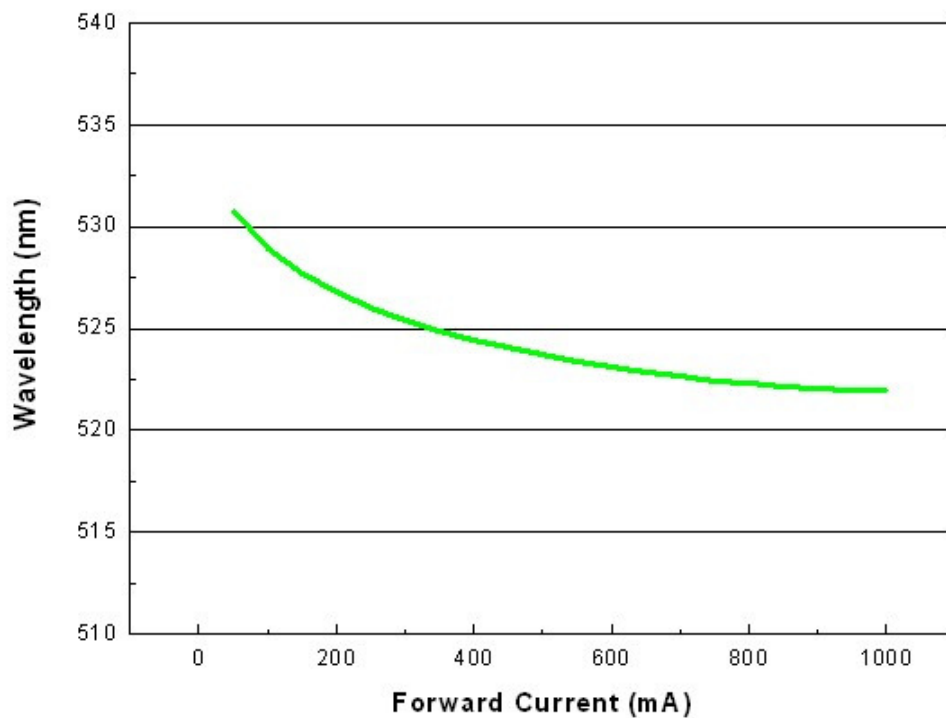

For Red @ Thermal Pad Temperature = 25°C

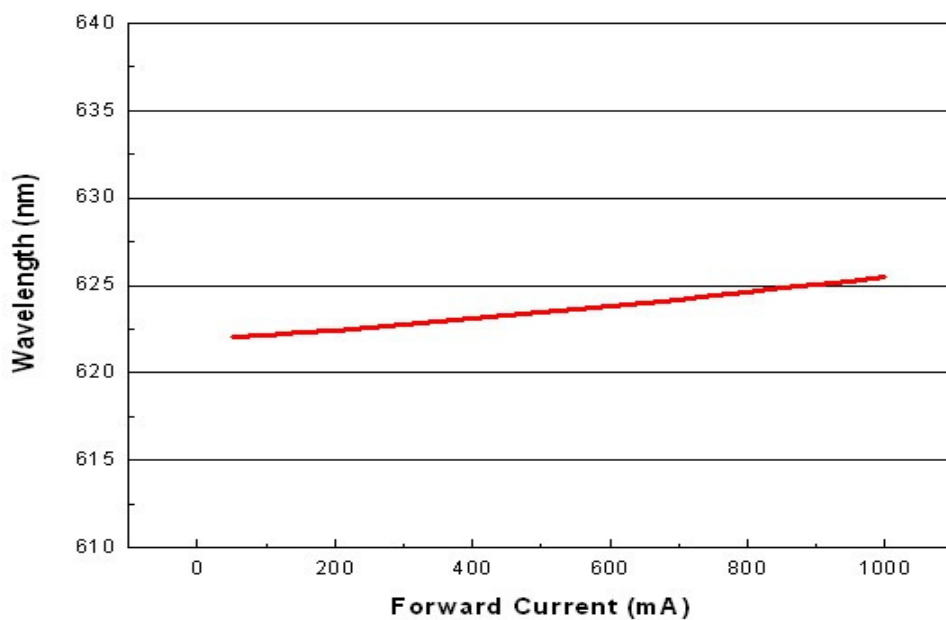

Relative Flux and Forward Voltage V.S. Junction Temperature (IF = 350 mA)

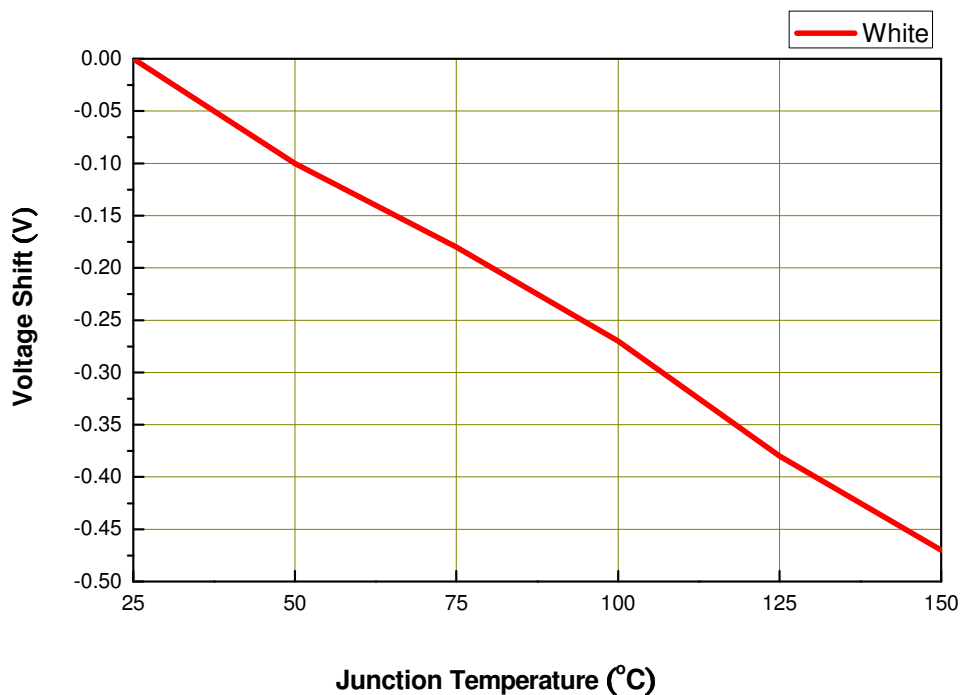
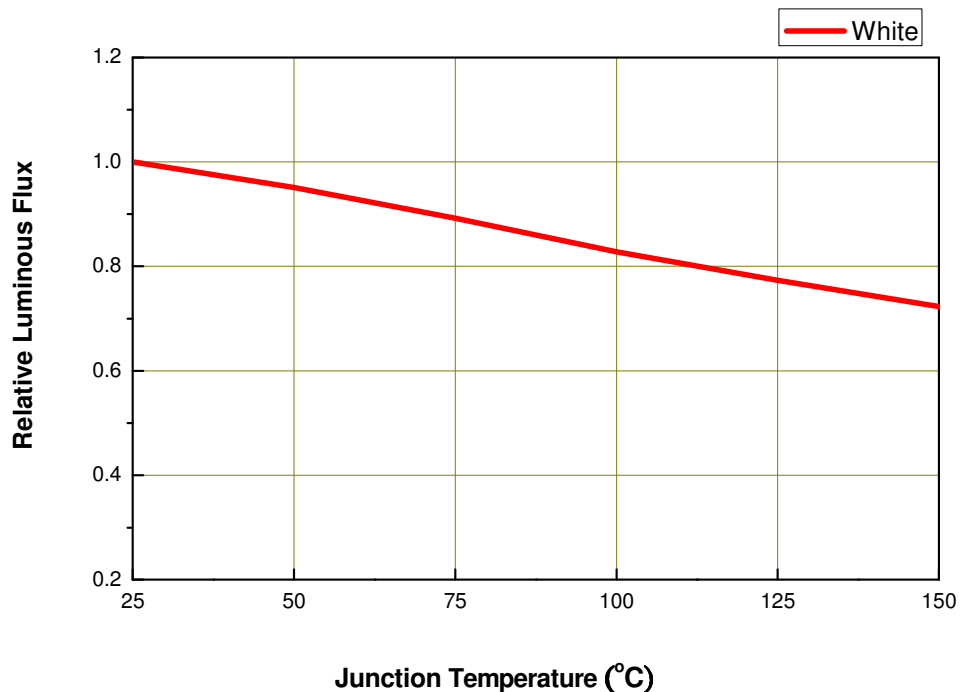

Current Derating Curves

Current Derating Curve for 700mA Drive Current Cool-White, Neutral-White, Warm-White, Green, Cyan, Blue, Royal-Blue,

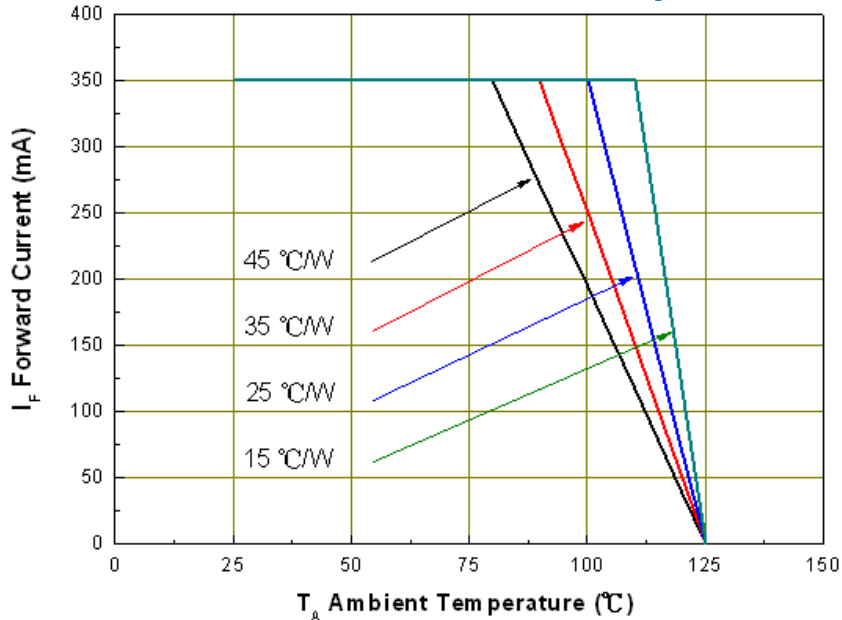

Current Derating Curve for 700mA Drive Current Far-Red, Deep-Red, Red, Amber, Yellow

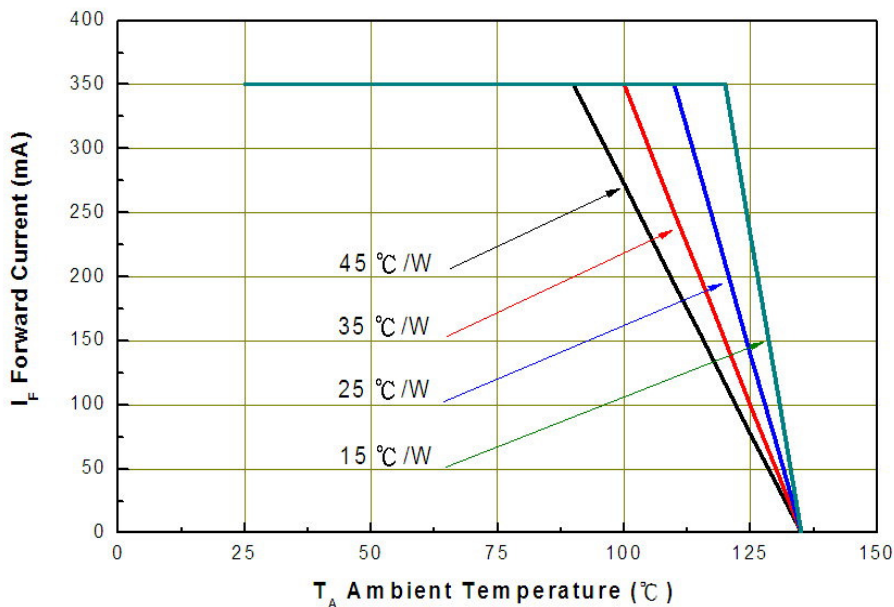

Note:

The current derating curves are depending on the thermal resistance between the junction to the soldering pad.

Typical Radiation Patterns

Shuen series: Typical Diagram Characteristics of Radiation for Cool-White, Neutral-White, Warm-White Lambertian

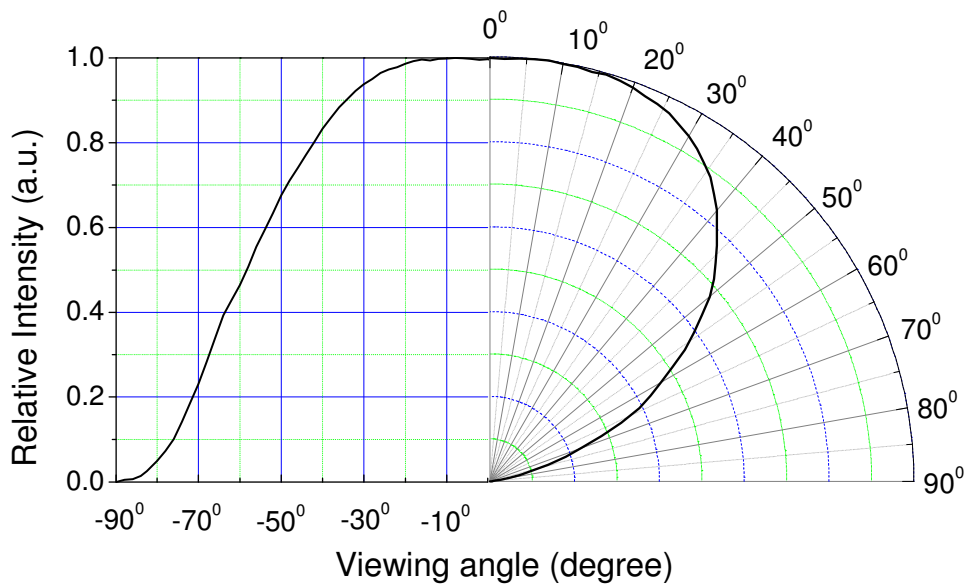

Shuen High Luminous Series Typical Diagram Characteristics of Radiation for Cool-White, Neutral-White, Warm-White Lambertian

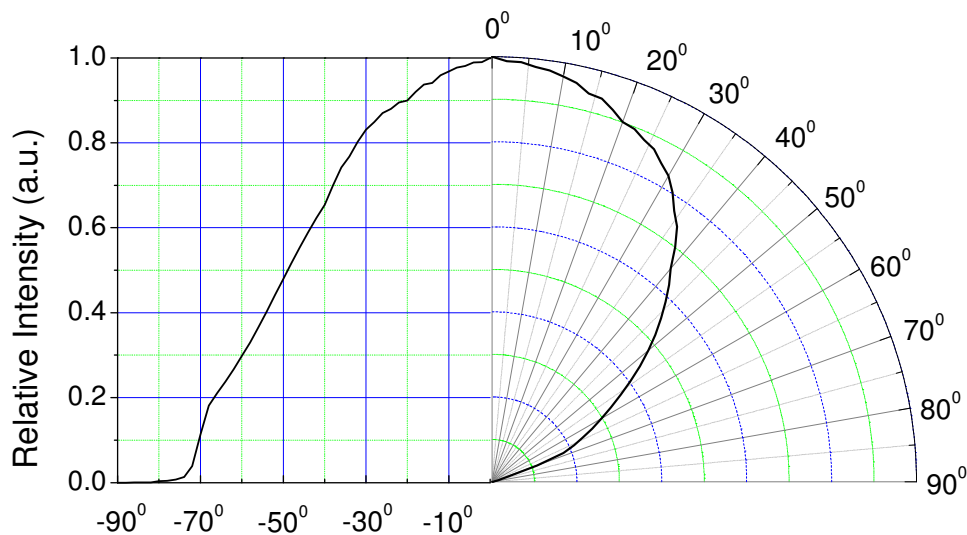

Notes:

1. $2\theta_{1/2}$ is the off axis angle from lamp centerline where the luminous intensity is 1/2 of the peak value.
2. View angle tolerance is $\pm 5^\circ$.

Emitter Tape Packaging

Carrier Tape Dimensions as the following:

Reel: 400pcs, $MOQ \geq 2K$ pcs(has to be a multiple of 400pcs)

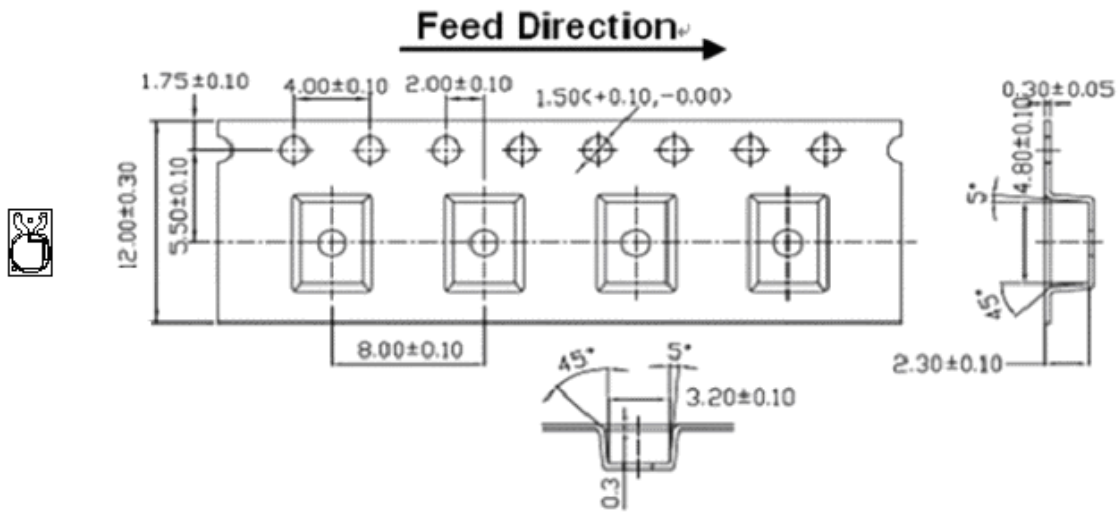

Note:

1. Dimensions are in millimeters.
2. Tolerances for fixed dimensions are ± 0.1 mm.

Moisture Resistant Packaging

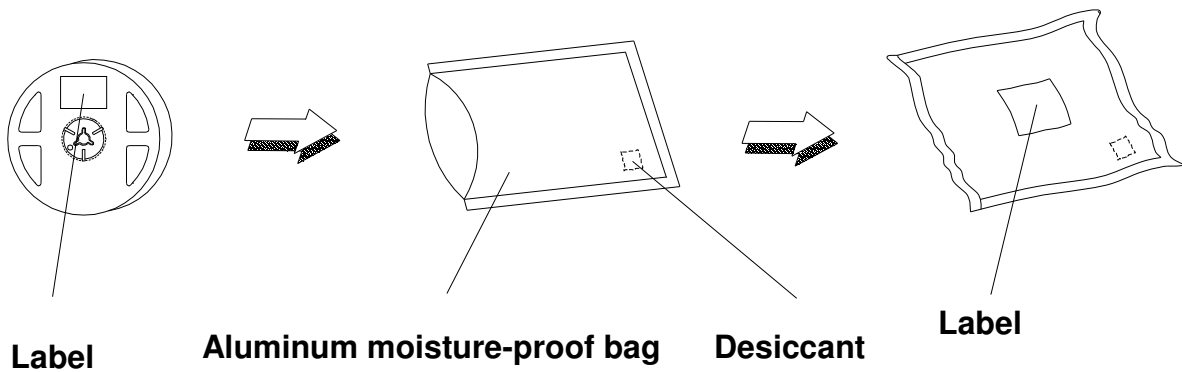

Emitter Reel Packaging

Reel Dimensions

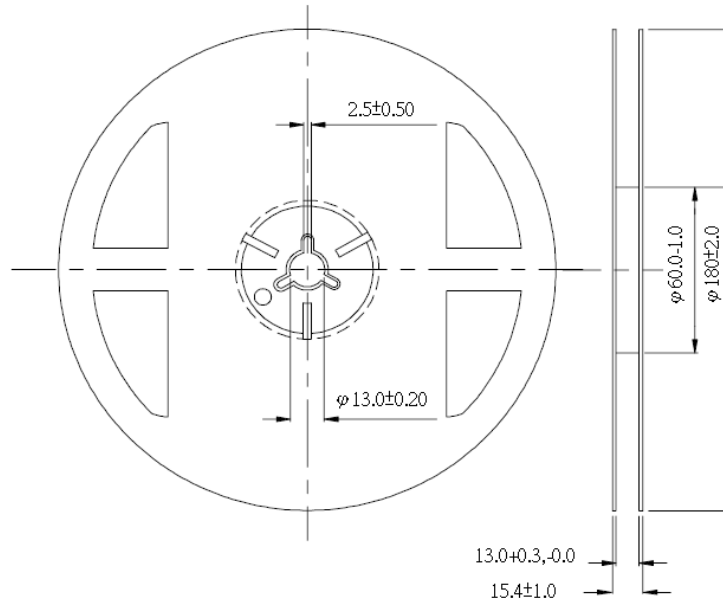

Note :

1. Dimensions are in millimeters.
2. Tolerances unless mentioned are ± 0.1 mm.

Product Labeling

Label Explanation

CPN: Customer Specification (when required)

P/N : Everlight Production Number

QTY: Packing Quantity

CAT: Luminous Flux (Brightness) Bin

HUE: Color Bin

REF: Forward Voltage Bin

LOT No: Lot Number

MADE IN TAIWAN: Production Place



Storage Conditions

- Before the package is opened. The LEDs should be stored at 30°C or less and 85%RH or less after being shipped from Everlight and the storage life limits are 1 year. If the LEDs are stored for 1 year or more, they can be stored for 3 years in a sealed container with a nitrogen atmosphere and moisture absorbent material.
- After opening the package: The LED's floor life is 1 year under 30°C or less and 60%RH or less. The LED should be soldered with 168hrs (7days) after opening the package. If unused LEDs remain, it should be stored in moisture proof packages.
- If the moisture absorbent material (silica gel) has faded away or the LEDs have exceeded the storage time, baking treatment should be performed using the following conditions. Baking treatment: 60±5°C for 24 hours.

Revision History

Current version: 11/07/2011
Device No. DHE-0001163
Version.9.0

Page	Subjects (major change in previous version)	Date of change
3、4、7	Modify Product Nomenclature、Absolute Maximum Ratings and remove color LEDs.	08/30/10
5、7、14	Add R,G,B,Y color LEDs.	10/11/10
5、6、7、8、30、34	Added new PN, radiation patterns and storage conditions.	04/28/11
4	Modify Thermal Resistance	05/05/11
18	Modify Mechanical Dimension	05/23/11
6、7、15、17	Add new PN, Modify Forward Voltage Bins and Optical Characteristics of white LED series.	06/17/11
32	Add PN. Modify Carrier Tape Dimensions	07/27/11
32、33	Modify the minimum amount of packaging Modify Typical Radiation Patterns	10/28/11

Компания «Life Electronics» занимается поставками электронных компонентов импортного и отечественного производства от производителей и со складов крупных дистрибьюторов Европы, Америки и Азии.

С конца 2013 года компания активно расширяет линейку поставок компонентов по направлению коаксиальный кабель, кварцевые генераторы и конденсаторы (керамические, пленочные, электролитические), за счёт заключения дистрибьюторских договоров

Мы предлагаем:

- Конкуренспособные цены и скидки постоянным клиентам.
- Специальные условия для постоянных клиентов.
- Подбор аналогов.
- Поставку компонентов в любых объемах, удовлетворяющих вашим потребностям.
- Приемлемые сроки поставки, возможна ускоренная поставка.
- Доставку товара в любую точку России и стран СНГ.
- Комплексную поставку.
- Работу по проектам и поставку образцов.
- Формирование склада под заказчика.
- Сертификаты соответствия на поставляемую продукцию (по желанию клиента).
- Тестирование поставляемой продукции.
- Поставку компонентов, требующих военную и космическую приемку.
- Входной контроль качества.
- Наличие сертификата ISO.

В составе нашей компании организован Конструкторский отдел, призванный помогать разработчикам, и инженерам.

Конструкторский отдел помогает осуществить:

- Регистрацию проекта у производителя компонентов.
- Техническую поддержку проекта.
- Защиту от снятия компонента с производства.
- Оценку стоимости проекта по компонентам.
- Изготовление тестовой платы монтаж и пусконаладочные работы.



Тел: +7 (812) 336 43 04 (многоканальный)

Email: org@lifeelectronics.ru