



Photocoupler

Product Data Sheet

LTV-8141 8241 8441
(M, S, S-TA1, S-TA, S-TP)
Series

Spec No.: DS-70-96-0014

Effective Date: 06/21/2013

Revision: F

LITE-ON DCC

RELEASE

BNS-OD-FC001/A4



FEATURES

- * AC input response
- * High current transfer ratio
(CTR : MIN. 600% at $I_F = \pm 1\text{mA}$, $V_{CE} = 2\text{V}$)
- * High input-output isolation voltage
($V_{iso} = 5,000\text{V}_{rms}$)
- * Response time
(t_r : TYP. $60\mu\text{s}$ at $V_{CE} = 2\text{V}$, $I_C = 10\text{mA}$, $R_L = 100\Omega$)
- * Dual-in-line package :
 - LTV-8141 : 1-channel type
 - LTV-8241 : 2-channel type
 - LTV-8441 : 4-channel type
- * Wide lead spacing package :
 - LTV-8141M : 1-channel type
 - LTV-8241M : 2-channel type
 - LTV-8441M : 4-channel type
- * Surface mounting package :
 - LTV-8141S : 1-channel type
 - LTV-8241S : 2-channel type
 - LTV-8441S : 4-channel type
- * Tape and reel packaging :
 - LTV-8141S-TA1, LTV-8241S-TA1
 - LTV-8141S-TA, LTV-8141S-TP
- * Safety approval
UL / TUV / FIMKO / NEMKO / DEMKO / SEMKO / VDE* approved
- *Required “V” ordering option**
- * RoHS compliant

OUTLINE DIMENSIONS

LTV-8141 :

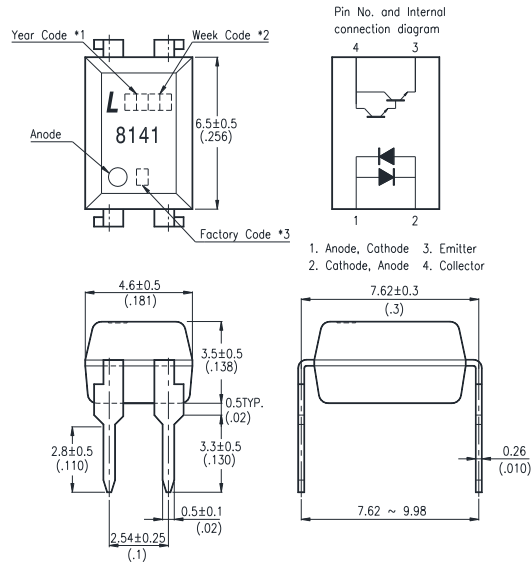

LTV-8241 :

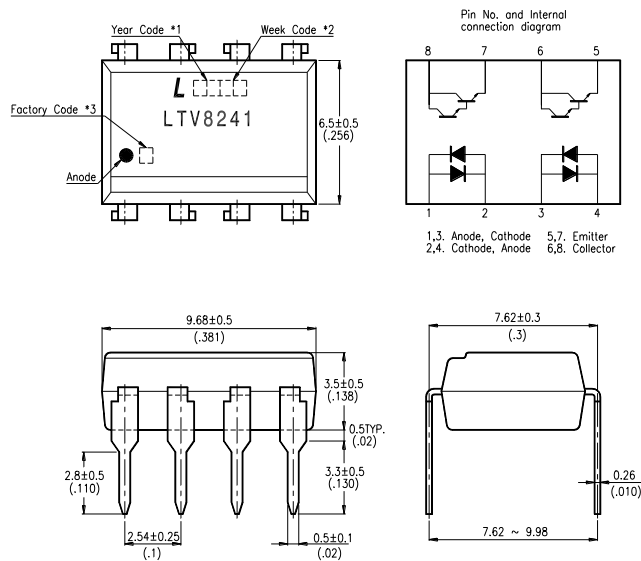

- *1. Year date code.
- *2. 2-digit work week.
- *3. Factory identification mark shall be marked.
(W: China-CZ, X : China-TJ, Y : Thailand)

OUTLINE DIMENSIONS

LTV-8441 :

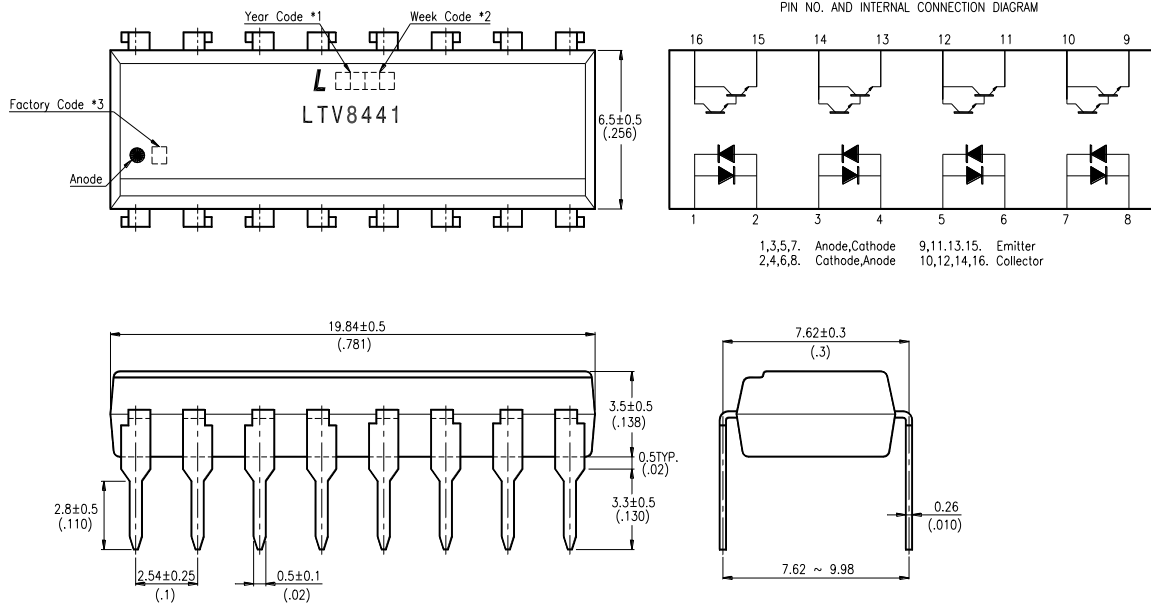

LTV-8141M :

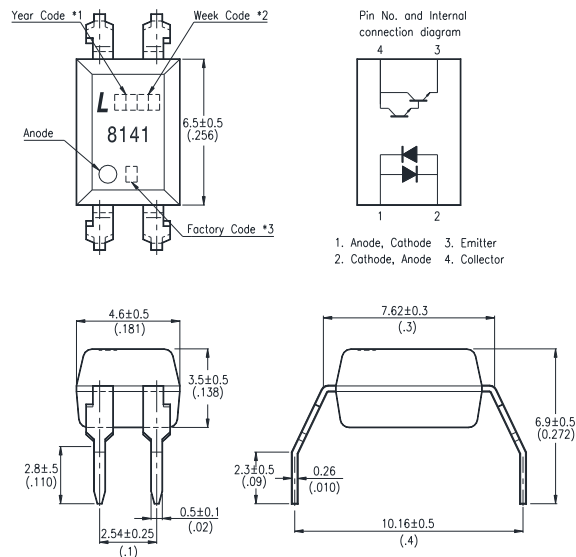

- *1. Year date code.
- *2. 2-digit work week.
- *3. Factory identification mark shall be marked.
(W: China-CZ, X : China-TJ, Y : Thailand)

OUTLINE DIMENSIONS

LTV-8241M :

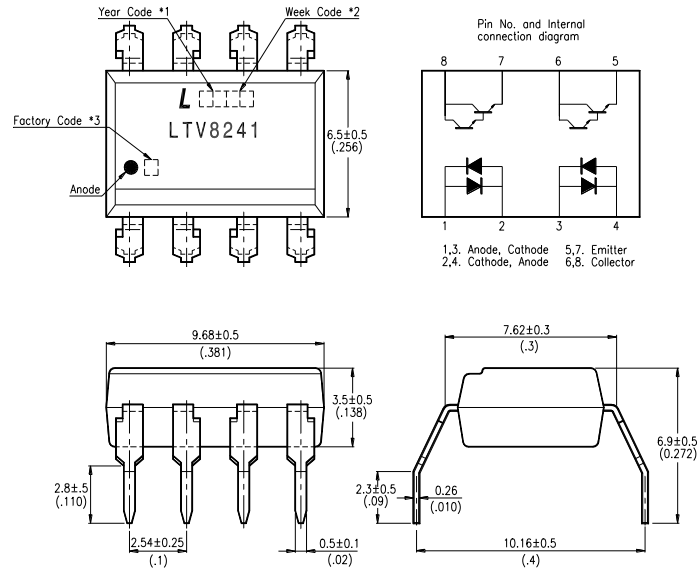

LTV-8441M :

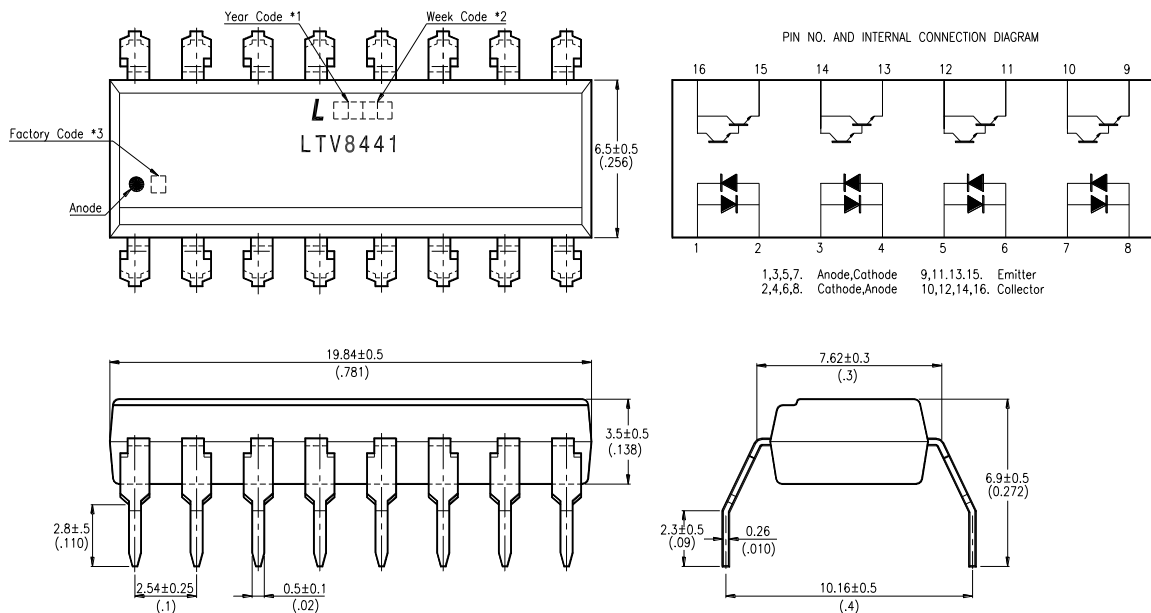

- *1. Year date code.
- *2. 2-digit work week.
- *3. Factory identification mark shall be marked.
(W: China-CZ, X : China-TJ, Y : Thailand)

OUTLINE DIMENSIONS

LTV-8141S :

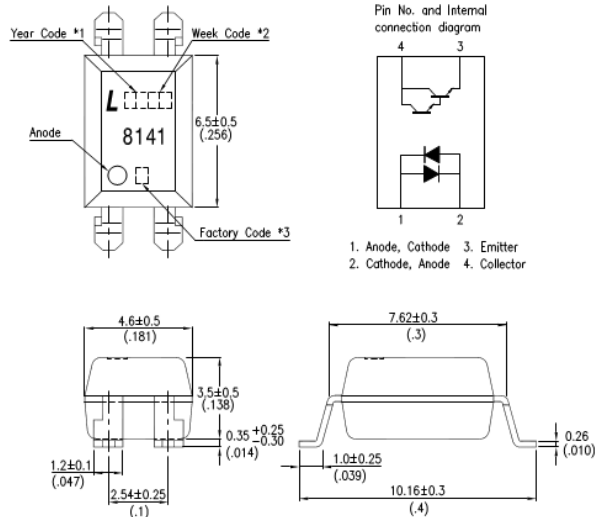

LTV-8241S :

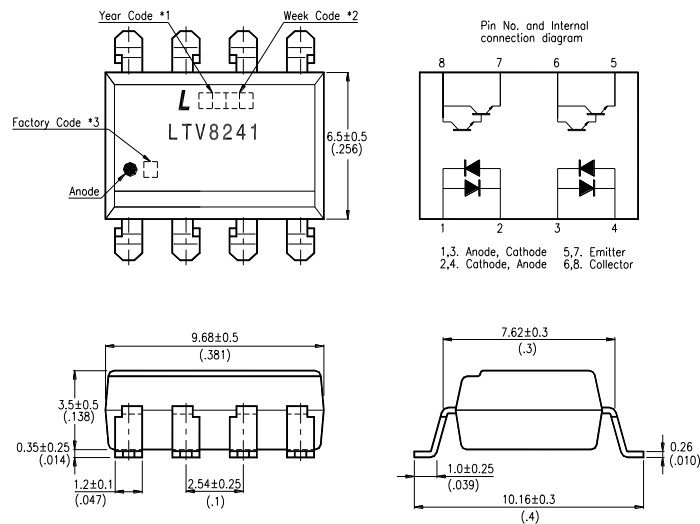

- *1. Year date code.
- *2. 2-digit work week.
- *3. Factory identification mark shall be marked.
(W: China-CZ, X : China-TJ, Y : Thailand)

OUTLINE DIMENSIONS

LTV-8441S :

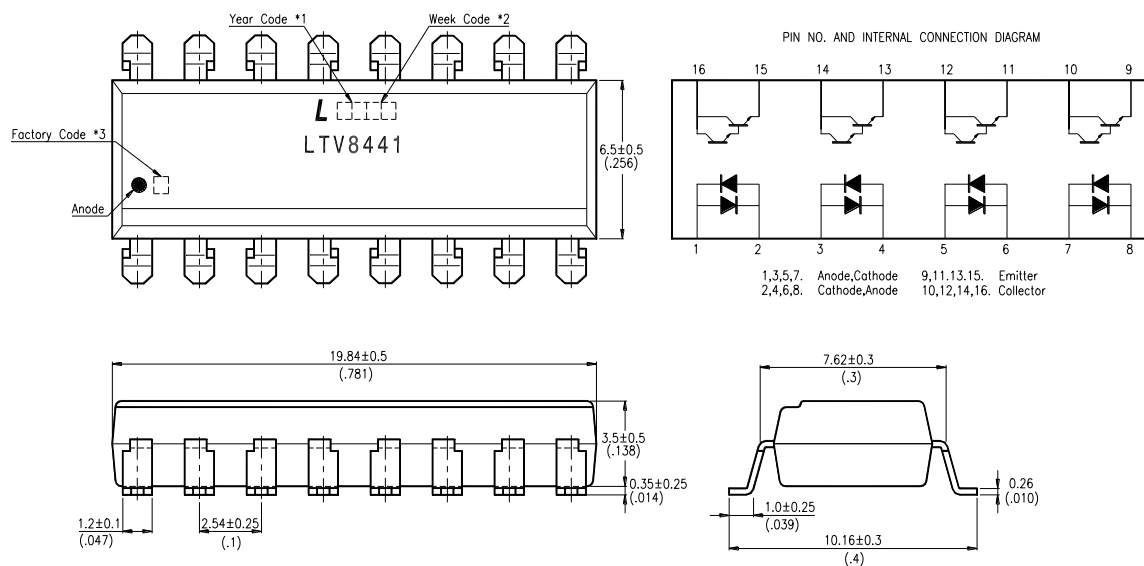

- *1. Year date code.
- *2. 2-digit work week.
- *3. Factory identification mark shall be marked.
(W: China-CZ, X : China-TJ, Y : Thailand)

TAPING DIMENSIONS

LTV-8141S-TA1 :

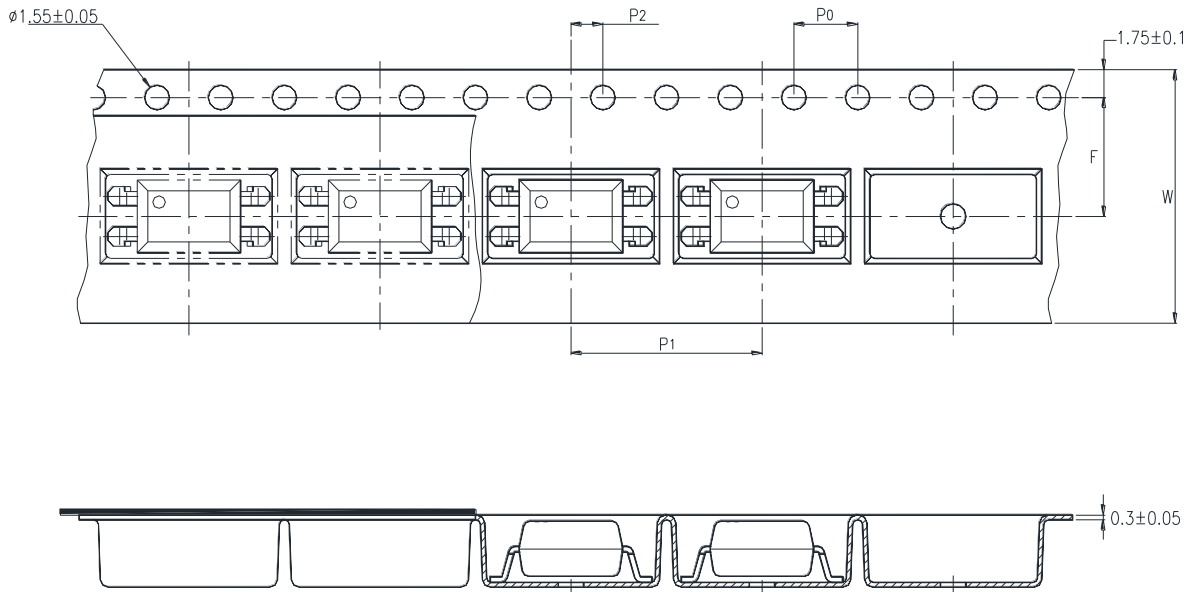

LTV-8241S-TA1 :

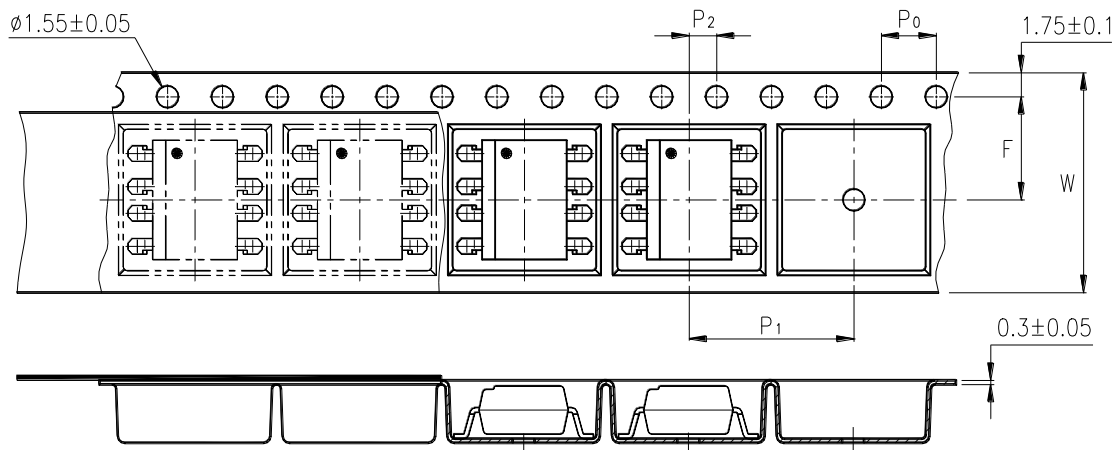

Description	Symbol	Dimensions in mm (inches)
Tape wide	W	16 ± 0.3 (.63)
Pitch of sprocket holes	P_0	4 ± 0.1 (.15)
Distance of compartment	F	7.5 ± 0.1 (.295)
	P_2	2 ± 0.1 (.079)
Distance of compartment to compartment	P_1	12 ± 0.1 (.472)

TAPING DIMENSIONS

LTV-8141S-TA :

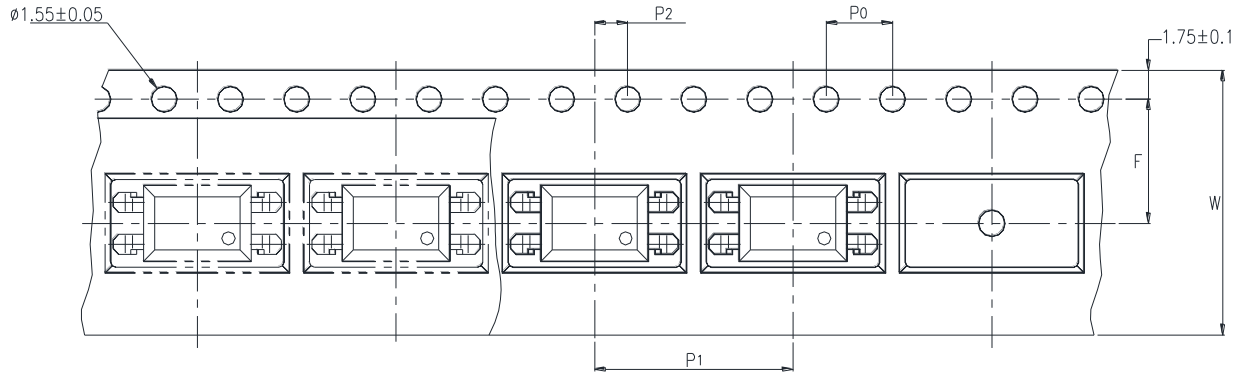

LTV-8141S-TP :

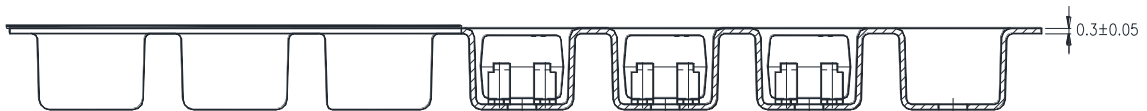
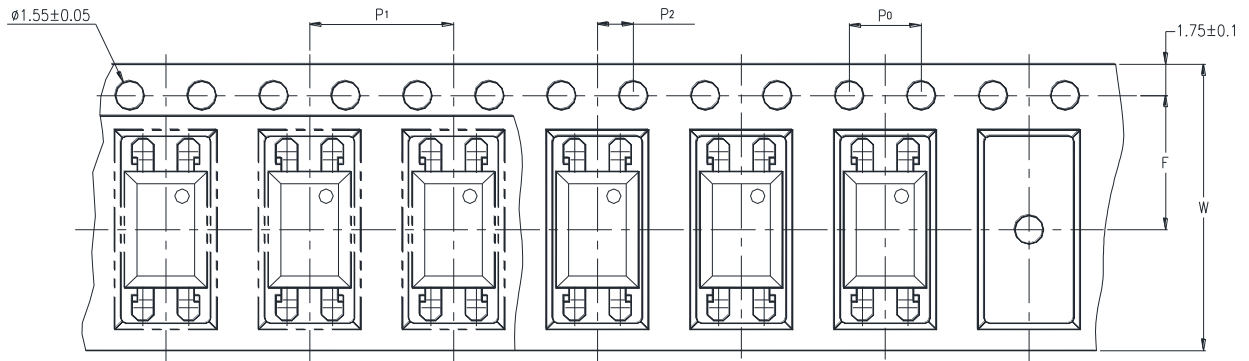

Description	Symbol	Dimensions in mm (inches)
Tape wide	W	16 ± 0.3 (.63)
Pitch of sprocket holes	P_0	4 ± 0.1 (.15)
Distance of compartment	F	7.5 ± 0.1 (.295)
Distance of compartment to compartment [Option: TA]	P_1	2 ± 0.1 (.079)
Distance of compartment to compartment [Option: TP]	P_1	12 ± 0.1 (.472)
Distance of compartment to compartment [Option: TP]	P_1	8 ± 0.1 (.315)

ABSOLUTE MAXIMUM RATING

(Ta = 25°C)

	PARAMETER	SYMBOL	RATING	UNIT
INPUT	Forward Current	I _F	±50	mA
	Power Dissipation	P	70	mW
OUTPUT	Collector - Emitter Voltage	V _{CEO}	35	V
	Emitter - Collector Voltage	V _{ECO}	6	V
	Collector Current	I _C	80	mA
	Collector Power Dissipation	P _C	150	mW
	Total Power Dissipation	P _{tot}	200	mW
	*1 Isolation Voltage	V _{iso}	5,000	V _{rms}
	Operating Temperature	T _{opr}	-30 ~ +100	°C
	Storage Temperature	T _{stg}	-55 ~ +125	°C
	*2 Soldering Temperature	T _{sol}	260	°C

*1. AC For 1 Minute, R.H. = 40 ~ 60%

Isolation voltage shall be measured using the following method.

- (1) Short between anode and cathode on the primary side and between collector and emitter on the secondary side.
- (2) The isolation voltage tester with zero-cross circuit shall be used.
- (3) The waveform of applied voltage shall be a sine wave.

*2. For 10 Seconds

ELECTRICAL - OPTICAL CHARACTERISTICS

(Ta = 25°C)

PARAMETER		SYMBOL	MIN.	TYP.	MAX.	UNIT	CONDITIONS
INPUT	Forward Voltage	V _F	—	1.2	1.4	V	I _F =±20mA
	Terminal Capacitance	C _t	—	50	250	pF	V=0, f=1KHz
OUTPUT	Collector Dark Current	I _{CEO}	—	—	1	μA	V _{CE} =10V, I _F =0
	Collector-Emitter Breakdown Voltage	BV _{CEO}	35	—	—	V	I _C =0.1mA I _F =0
	Emitter-Collector Breakdown Voltage	BV _{ECO}	6	—	—	V	I _E =10μA I _F =0
TRANSFER CHARACTERISTICS	Collector Current	I _C	6	—	75	mA	I _F =±1mA V _{CE} =2V
	* Current Transfer Ratio	CTR	600	—	7,500	%	
	Collector-Emitter Saturation Voltage	V _{CE(sat)}	—	0.8	1	V	I _F =±20mA I _C =5mA
	Isolation Resistance	R _{iso}	5×10 ¹⁰	1×10 ¹¹	—	Ω	DC500V 40 ~ 60% R.H.
	Floating Capacitance	C _f	—	0.6	1	pF	V=0, f=1MHz
	Cut-Off Frequency	f _c	1	6	—	KHz	V _{CE} =5V, I _C =2mA R _L =100Ω, -3dB
	Response Time (Rise)	t _r	—	60	300	μs	V _{CE} =2V, I _C =10mA R _L =100Ω
	Response Time (Fall)	t _f	—	53	250	μs	

$$* \text{CTR} = \frac{I_C}{I_F} \times 100\%$$

CHARACTERISTICS CURVES

Fig.1 Forward Current vs. Ambient Temperature

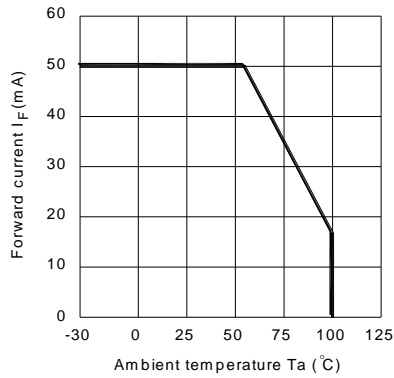

Fig.2 Collector Power Dissipation vs. Ambient Temperature

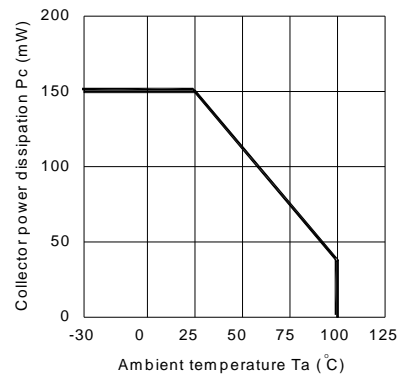

Fig.3 Collector-emitter Saturation Voltage vs. Forward Current

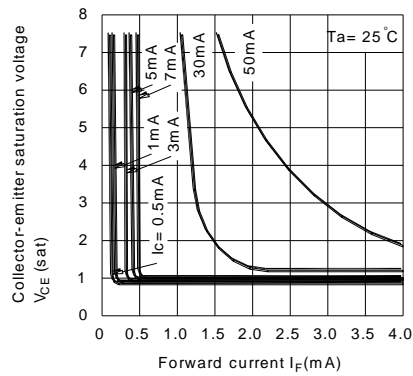

Fig.4 Forward Current vs. Forward Voltage

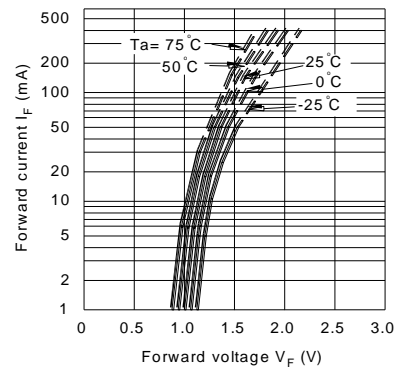

Fig.5 Current Transfer Ratio vs. Forward Current

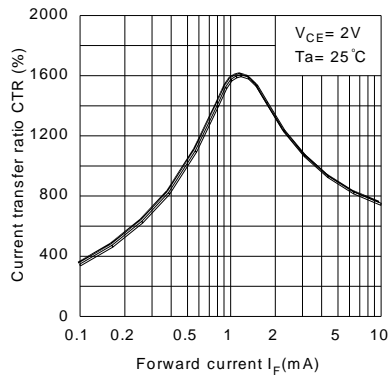
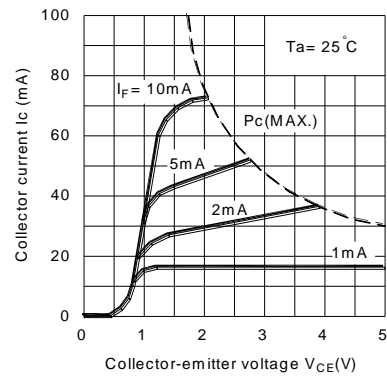

Fig.6 Collector Current vs. Collector-emitter Voltage



CHARACTERISTICS CURVES

Fig.7 Relative Current Transfer Ratio vs. Ambient Temperature

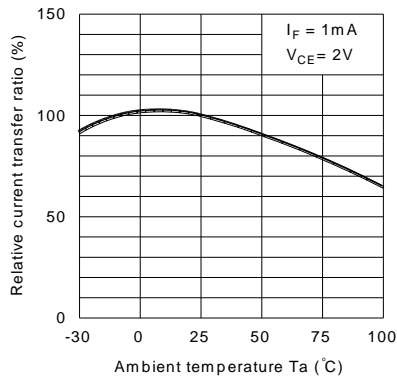

Fig.8 Collector-emitter Saturation Voltage vs. Ambient Temperature

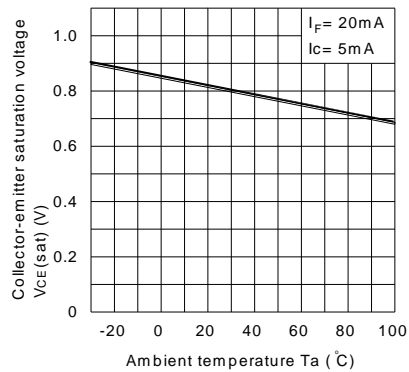

Fig.9 Collector Dark Current vs. Ambient Temperature

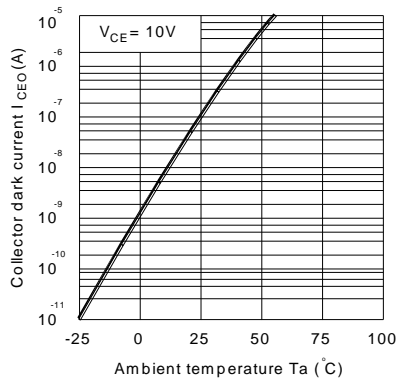

Fig.10 Response Time vs. Load Resistance

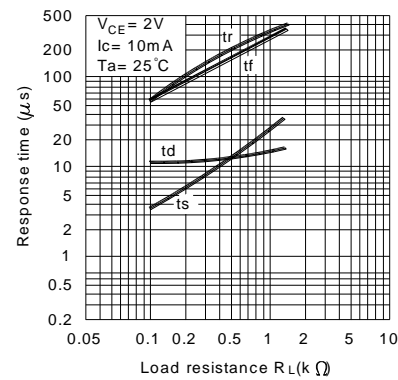
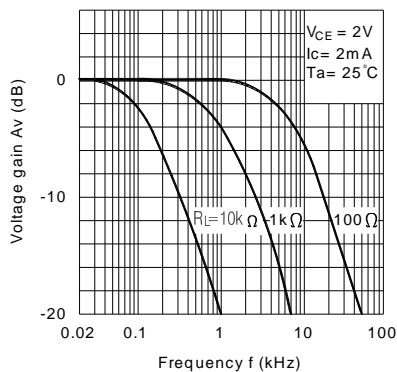
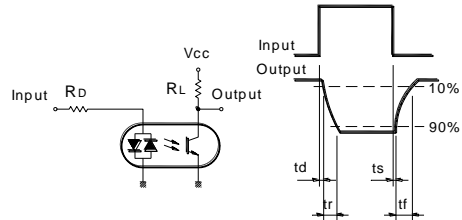

Fig.11 Frequency Response



Test Circuit for Response Time



Test Circuit for Frequency Response

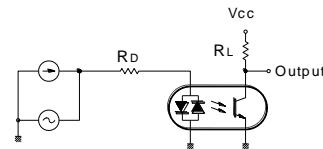

RECOMMENDED FOOT PRINT PATTERNS (MOUNT PAD)

Unit : mm

4 PIN

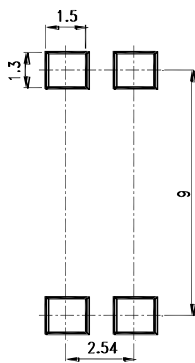

8 PIN

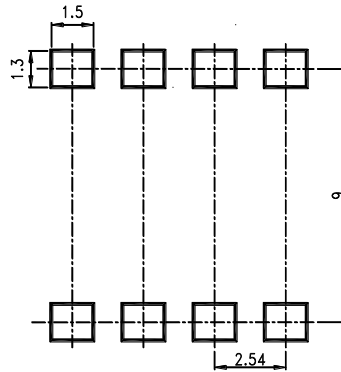

16 PIN

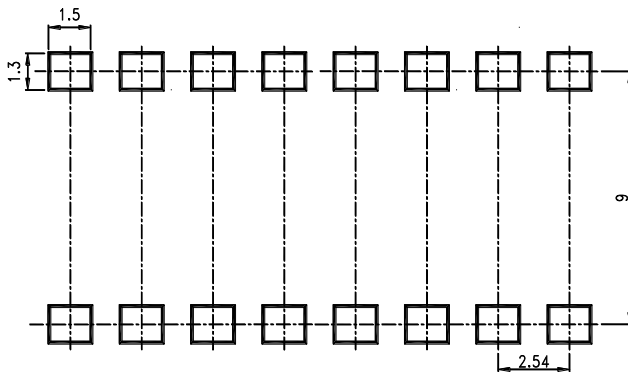

Mouser Electronics

Authorized Distributor

Click to View Pricing, Inventory, Delivery & Lifecycle Information:

[Lite-On:](#)

[LTV-8241S](#) [LTV-8141](#) [LTV-8141S](#) [LTV-8141M](#) [LTV-8241S-TA](#) [LTV-8241S-TA1](#) [LTV-8141S-TA](#) [LTV-8241](#) [LTV-8441S](#) [LTV-8141S-TA1](#) [LTV-8441](#)

Компания «Life Electronics» занимается поставками электронных компонентов импортного и отечественного производства от производителей и со складов крупных дистрибьюторов Европы, Америки и Азии.

С конца 2013 года компания активно расширяет линейку поставок компонентов по направлению коаксиальный кабель, кварцевые генераторы и конденсаторы (керамические, пленочные, электролитические), за счёт заключения дистрибьюторских договоров

Мы предлагаем:

- Конкурентоспособные цены и скидки постоянным клиентам.
- Специальные условия для постоянных клиентов.
- Подбор аналогов.
- Поставку компонентов в любых объемах, удовлетворяющих вашим потребностям.
- Приемлемые сроки поставки, возможна ускоренная поставка.
- Доставку товара в любую точку России и стран СНГ.
- Комплексную поставку.
- Работу по проектам и поставку образцов.
- Формирование склада под заказчика.
- Сертификаты соответствия на поставляемую продукцию (по желанию клиента).
- Тестирование поставляемой продукции.
- Поставку компонентов, требующих военную и космическую приемку.
- Входной контроль качества.
- Наличие сертификата ISO.

В составе нашей компании организован Конструкторский отдел, призванный помогать разработчикам, и инженерам.

Конструкторский отдел помогает осуществить:

- Регистрацию проекта у производителя компонентов.
- Техническую поддержку проекта.
- Защиту от снятия компонента с производства.
- Оценку стоимости проекта по компонентам.
- Изготовление тестовой платы монтаж и пусконаладочные работы.



Тел: +7 (812) 336 43 04 (многоканальный)
Email: org@lifeelectronics.ru