



**S27KL0641/S27KS0641
S70KL1281/S70KS1281**

3.0 V/1.8 V, 64 Mb (8 MB)/128 Mb (16 MB), HyperRAM™ Self-Refresh DRAM

Distinctive Characteristics

HyperRAM™ Low Signal Count Interface

- 3.0 V I/O, 11 bus signals
 - Single ended clock (CK)
- 1.8 V I/O, 12 bus signals
 - Differential clock (CK, CK#)
- Chip Select (CS#)
- 8-bit data bus (DQ[7:0])
- Read-Write Data Strobe (RWDS)
 - Bidirectional Data Strobe / Mask
 - Output at the start of all transactions to indicate refresh latency
 - Output during read transactions as Read Data Strobe
 - Input during write transactions as Write Data Mask
- RWDS DCARS Timing
 - During read transactions RWDS is offset by a second clock, phase shifted from CK
 - The Phase Shifted Clock is used to move the RWDS transition edge within the read data eye

- Up to 333 MBps
- Double-Data Rate (DDR) - two data transfers per clock
- 166 MHz clock rate (333 MBps) at 1.8 V V_{CC}
- 100 MHz clock rate (200 MBps) at 3.0 V V_{CC}
- Sequential burst transactions
- Configurable Burst Characteristics
 - Wrapped burst lengths:
 - 16 bytes (8 clocks)
 - 32 bytes (16 clocks)
 - 64 bytes (32 clocks)
 - 128 bytes (64 clocks)
 - Linear burst
 - Hybrid option - one wrapped burst followed by linear burst
 - Wrapped or linear burst type selected in each transaction
 - Configurable output drive strength
- Low Power Modes
 - Deep Power Down
- Package
 - 24-ball FBGA

High Performance

Performance Summary

Read Transaction Timings	
Maximum Clock Rate at 1.8 V V _{CC} /V _{CCQ}	166 MHz
Maximum Clock Rate at 3.0 V V _{CC} /V _{CCQ}	100 MHz
Maximum Access Time, (t _{ACC} at 166 MHz)	36 ns
Maximum CS# Access Time to first word at 166 MHz (excluding refresh latency)	56 ns

Maximum Current Consumption	64 MB	128 MB
Burst Read or Write (linear burst at 166 MHz, 1.8 V)	60 mA	72 mA
Power On Reset	50 mA	100 mA
Standby (CS# = HIGH, 3.0 V, 105 °C)	300 µA	600 µA
Deep Power Down (CS# = HIGH, 3.0 V, 105 °C)	40 µA	N/A
Standby (CS# = HIGH, 1.8 V, 105 °C)	300 µA	600 µA
Deep Power Down (CS# = HIGH, 1.8 V, 105 °C)	20 µA	N/A

Logic Block Diagrams

Block Diagram — 64 Mb

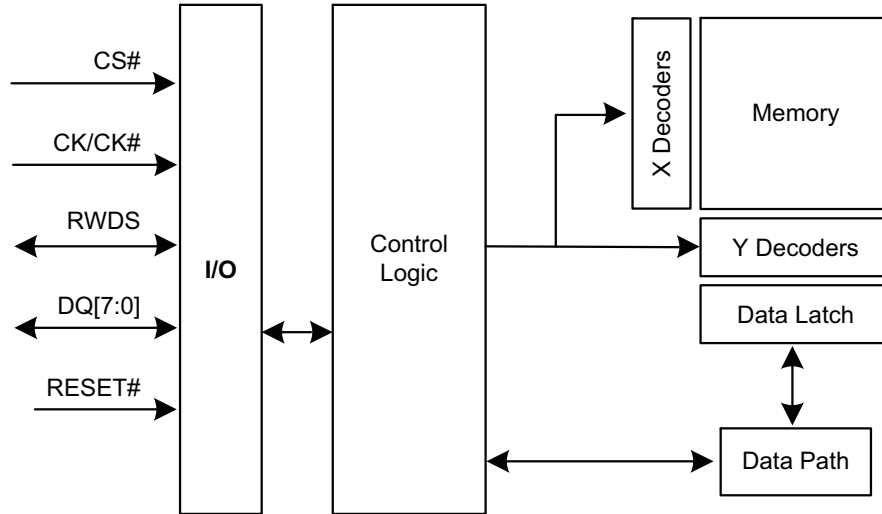

Block Diagram — 128 Mb



HyperRAM Block Diagram

HyperRAM Connections, Including Optional Signals



Contents

1. General Description	5	8. Timing Specifications	35
2. Product Overview	8	8.1 Key to Switching Waveforms	35
3. Signal Descriptions	9	8.2 AC Test Conditions	35
3.1 Input/Output Summary	9	8.3 AC Characteristics	36
3.2 Command/Address Bit Assignments	10	9. Physical Interface	39
3.3 Read Transactions	14	9.1 FBGA 24-Ball 5 x 5 Array Footprint	39
3.4 Write Transactions with Initial Latency (Memory Core Write)	15	9.2 Physical Diagrams	40
3.5 Write Transactions without Initial Latency (Register Write)	17	10. DDR Center Aligned Read Strobe (DCARS) Functionality	41
4. Memory Space	18	10.1 HyperRAM Products with DCARS Signal Descriptions	41
5. Register Space	18	10.2 HyperRAM Products with DCARS — FBGA 24-ball, 5 x 5 Array Footprint	42
5.1 Device Identification Registers	19	10.3 HyperRAM Memory with DCARS Timing	42
5.2 Register Space Access	20	11. Ordering Information	44
6. Interface States	26	11.1 Ordering Part Number	44
6.1 Power Conservation Modes	27	11.2 Valid Combinations	45
7. Electrical Specifications	28	11.3 Valid Combinations — Automotive Grade / AEC-Q100	47
7.1 Absolute Maximum Ratings	28	12. Revision History	49
7.2 Latchup Characteristics	29	Sales, Solutions, and Legal Information	51
7.3 Operating Ranges	29	Worldwide Sales and Design Support	51
7.4 DC Characteristics	30	Products	51
7.5 Power-Up Initialization	32	PSoC® Solutions	51
7.6 Power Down	33	Cypress Developer Community	51
7.7 Hardware Reset	34	Technical Support	51

1. General Description

The Cypress® 64-Mb HyperRAM™ device is a high-speed CMOS, self-refresh Dynamic RAM (DRAM), with a HyperBus interface. The Cypress 128-Mb HyperRAM is a dual-die stack of 64-Mb HyperRAM devices in a single package.

The Random Access Memory (RAM) array uses dynamic cells that require periodic refresh. Refresh control logic within the device manages the refresh operations on the RAM array when the memory is not being actively read or written by the HyperBus interface master (host). Since the host is not required to manage any refresh operations, the DRAM array appears to the host as though the memory uses static cells that retain data without refresh. Hence, the memory can also be described as Pseudo Static RAM (PSRAM).

Because the DRAM cells cannot be refreshed during a read or write transaction, there is a requirement that the host not perform read or write burst transfers that are long enough to block the necessary internal logic refresh operations when they are needed. The host is required to limit the duration of transactions and allow additional initial access latency, at the beginning of a new transaction, if the memory indicates a refresh operation is needed.

HyperBus is a low-signal-count, Double Data Rate (DDR) interface that achieves high-speed read and write throughput. The DDR protocol transfers two data bytes per clock cycle on the DQ input/output signals. A read or write transaction on HyperBus consists of a series of 16-bit wide, one clock cycle data transfers at the internal HyperRAM core with two corresponding 8-bit wide, one-half-clock-cycle data transfers on the DQ signals. All inputs and outputs are LV-CMOS compatible. Ordering Part Number (OPN) device versions are available for core (V_{CC}) and IO buffer (V_{CCQ}) supplies of either 1.8 V or 3.0 V (nominal).

Command, address, and data information is transferred over the eight HyperBus DQ[7:0] signals. The clock is used for information capture by a HyperBus slave device when receiving command, address, or data on the DQ signals. Command or Address values are center aligned with clock transitions.

Every transaction begins with the assertion of CS# and Command-Address (CA) signals, followed by the start of clock transitions to transfer six CA bytes, followed by initial access latency and either read or write data transfers, until CS# is deasserted.

Figure 1. Read Transaction, Single Initial Latency Count



The Read/Write Data Strobe (RWDS) is a bidirectional signal that indicates:

- when data will start to transfer from a HyperRAM device to the master device in read transactions (initial read latency)
- when data is being transferred from a HyperRAM device to the master device during read transactions (as a source synchronous read data strobe)
- when data may start to transfer from the master device to a HyperRAM device in write transactions (initial write latency)
- data masking during write data transfers

During the CA transfer portion of a read or write transaction, RWDS acts as an output from a HyperRAM device to indicate whether additional initial access latency is needed in the transaction.

During read data transfers, RWDS is a read data strobe with data values edge aligned with the transitions of RWDS.

Figure 2. Read Transaction, Additional Latency Count

During write data transfers, RWDS indicates whether each data byte transfer is masked with RWDS HIGH (invalid and prevented from changing the byte location in a memory) or not masked with RWDS LOW (valid and written to a memory). Data masking may be used by the host to byte align write data within a memory or to enable merging of multiple non-word aligned writes in a single burst write. During write transactions, data is center aligned with clock transitions.

Figure 3. Write Transaction, Single Initial Latency Count

Read and write transactions are burst oriented, transferring the next sequential word during each clock cycle. Each individual read or write transaction can use either a wrapped or linear burst sequence.

Figure 4. Linear Versus Wrapped Burst Sequence

During wrapped transactions, accesses start at a selected location and continue to the end of a configured word group aligned boundary, then wrap to the beginning location in the group, then continue back to the starting location. Wrapped bursts are generally used for critical word first cache line fill read transactions. During linear transactions, accesses start at a selected location and continue in a sequential manner until the transaction is terminated when CS# returns HIGH. Linear transactions are generally used for large contiguous data transfers such as graphic images. Since each transaction command selects the type of burst sequence for that transaction, wrapped and linear bursts transactions can be dynamically intermixed as needed.

2. Product Overview

The 64-Mb and 128-Mb HyperRAM devices are 1.8 V or 3.0 V core and I/O, synchronous self-refresh Dynamic RAM (DRAM). The HyperRAM device provides a HyperBus slave interface to the host system. HyperBus has an 8-bit (1 byte) wide DDR data bus and uses only word-wide (16-bit data) address boundaries. Read transactions provide 16 bits of data during each clock cycle (8 bits on both clock edges). Write transactions take 16 bits of data from each clock cycle (8 bits on each clock edge).

Figure 5. HyperRAM Interface



Read and write transactions require two clock cycles to define the target row address and burst type, then an initial access latency of t_{ACC} . During the Command-Address (CA) part of a transaction, the memory will indicate whether an additional latency for a required refresh time (t_{RFH}) is added to the initial latency; by driving the RWDS signal to the HIGH state. During the CA period the third clock cycle will specify the target word address within the target row. During a read (or write) transaction, after the initial data value has been output (or input), additional data can be read from (or written to) the row on subsequent clock cycles in either a wrapped or linear sequence. When configured in linear burst mode, the device will automatically fetch the next sequential row from the memory array to support a continuous linear burst. Simultaneously accessing the next row in the array while the read or write data transfer is in progress, allows for a linear sequential burst operation that can provide a sustained data rate of 333 MBps (1 byte (8 bit data bus) * 2 (data clock edges) * 166 MHz = 333 MBps).

3. Signal Descriptions

3.1 Input/Output Summary

HyperRAM signals are shown in [Table 1](#). Active LOW signal names have a hash symbol (#) suffix.

Table 1. I/O Summary

Symbol	Type	Description
CS#	Master Output, Slave Input	Chip Select. Bus transactions are initiated with a HIGH to LOW transition. Bus transactions are terminated with a LOW to HIGH transition. The master device has a separate CS# for each slave.
CK, CK#	Master Output, Slave Input	Differential Clock. Command, address, and data information is output with respect to the crossing of the CK and CK# signals. Differential clock is used on 1.8 V I/O devices. Single Ended Clock. CK# is not used on 3.0 V devices, only a single ended CK is used. The clock is not required to be free-running.
DQ[7:0]	Input/Output	Data Input/Output. Command, Address, and Data information is transferred on these signals during Read and Write transactions.
RWDS	Input/Output	Read Write Data Strobe. During the Command/Address portion of all bus transactions RWDS is a slave output and indicates whether additional initial latency is required. Slave output during read data transfer, data is edge aligned with RWDS. Slave input during data transfer in write transactions to function as a data mask. (HIGH = additional latency, LOW = no additional latency).
RESET#	Master Output, Slave Input, Internal Pull-up	Hardware RESET. When LOW the slave device will self initialize and return to the Standby state. RWDS and DQ[7:0] are placed into the HI-Z state when RESET# is LOW. The slave RESET# input includes a weak pull-up, if RESET# is left unconnected it will be pulled up to the HIGH state.
V _{CC}	Power Supply	Power.
V _{CCQ}	Power Supply	Input/Output Power.
V _{SS}	Power Supply	Ground.
V _{SSQ}	Power Supply	Input/Output Ground.
RFU	No Connect	Reserved for Future Use. May or may not be connected internally, the signal/ball location should be left unconnected and unused by PCB routing channel for future compatibility. The signal/ball may be used by a signal in the future.

3.2 Command/Address Bit Assignments

All HyperRAM bus transactions can be classified as either read or write. A bus transaction is started with CS# going LOW with clock in idle state (CK=LOW and CK#=HIGH). The first three clock cycles transfer three words of Command/Address (CA0, CA1, CA2) information to define the transaction characteristics. The Command/Address words are presented with DDR timing, using the first six clock edges. The following characteristics are defined by the Command/Address information:

- Read or Write transaction
- Address Space: memory array space or register space
 - Register space is used to access Device Identification (ID) registers and Configuration Registers (CR) that identify the device characteristics and determine the slave specific behavior of read and write transfers on the HyperBus interface.
- Whether a transaction will use a linear or wrapped burst sequence.
- The target row (and half-page) address (upper order address)
- The target column (word within half-page) address (lower order address)

Figure 6. Command-Address Sequence^[1, 2, 3]

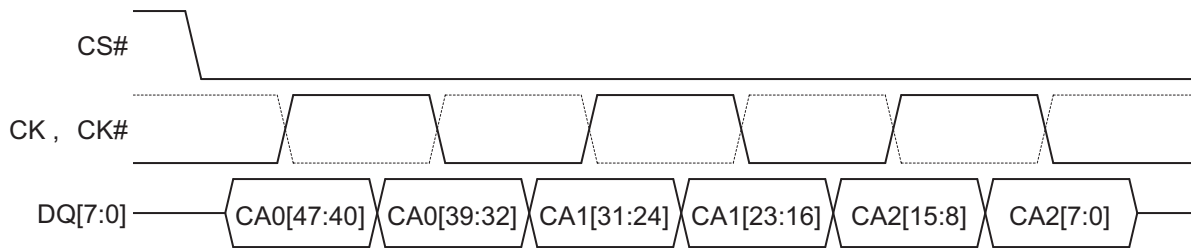

Table 2. Command-Address Bit Assignment to DQ Signals

Signal	CA0[47:40]	CA0[39:32]	CA1[31:24]	CA1[23:16]	CA2[15:8]	CA2[7:0]
DQ[7]	CA[47]	CA[39]	CA[31]	CA[23]	CA[15]	CA[7]
DQ[6]	CA[46]	CA[38]	CA[30]	CA[22]	CA[14]	CA[6]
DQ[5]	CA[45]	CA[37]	CA[29]	CA[21]	CA[13]	CA[5]
DQ[4]	CA[44]	CA[36]	CA[28]	CA[20]	CA[12]	CA[4]
DQ[3]	CA[43]	CA[35]	CA[27]	CA[19]	CA[11]	CA[3]
DQ[2]	CA[42]	CA[34]	CA[26]	CA[18]	CA[10]	CA[2]
DQ[1]	CA[41]	CA[33]	CA[25]	CA[17]	CA[9]	CA[1]
DQ[0]	CA[40]	CA[32]	CA[24]	CA[16]	CA[8]	CA[0]

Notes

1. Figure shows the initial three clock cycles of all transactions on the HyperBus.
2. CK# of differential clock is shown as dashed line waveform.
3. Command-Address information is "center aligned" with the clock during both Read and Write transactions.

Table 3. Command/Address Bit Assignments^[4, 5, 6, 7, 8]

CA Bit#	Bit Name	Bit Function
47	R/W#	Identifies the transaction as a read or write. R/W# = 1 indicates a Read transaction R/W# = 0 indicates a Write transaction
46	Address Space (AS)	Indicates whether the read or write transaction accesses the memory or register space. AS = 0 indicates memory space AS = 1 indicates the register space The register space is used to access device ID and Configuration registers.
45	Burst Type	Indicates whether the burst will be linear or wrapped. Burst Type = 0 indicates wrapped burst Burst Type = 1 indicates linear burst
44-16	Row & Upper Column Address	Row & Upper Column component of the target address: System word address bits A31-A3 Any upper Row address bits not used by a particular device density should be set to 0 by the host controller master interface. The size of Rows and therefore the address bit boundary between Row and Column address is slave device dependent.
15-3	Reserved	Reserved for future column address expansion. Reserved bits are don't care in current HyperBus devices but should be set to 0 by the host controller master interface for future compatibility.
2-0	Lower Column Address	Lower Column component of the target address: System word address bits A2-0 selecting the starting word within a half-page.

Notes

- A Row is a group of words relevant to the internal memory array structure and additional latency may be inserted by RWDS when crossing Row boundaries - this is device dependent behavior, refer to each HyperBus device data sheet for additional information. Also, the number of Rows may be used in the calculation of a distributed refresh interval for HyperRAM memory.
- A Page is a 16-word (32-byte) length and aligned unit of device internal read or write access and additional latency may be inserted by RWDS when crossing Page boundaries - this is device dependent behavior, refer to each HyperBus device data sheet for additional information.
- The Column address selects the burst transaction starting word location within a Row. The Column address is split into an upper and lower portion. The upper portion selects an 8-word (16-byte) Half-page and the lower portion selects the word within a Half-page where a read or write transaction burst starts.
- The initial read access time starts when the Row and Upper Column (Half-page) address bits are captured by a slave interface. Continuous linear read burst is enabled by memory devices internally interleaving access to 16 byte half-pages.
- HyperBus protocol address space limit, assuming:
29 Row & Upper Column address bits
3 Lower Column address bits
Each address selects a word wide (16 bit = 2 byte) data value
29 + 3 = 32 address bits = 4G addresses supporting 8Gbyte (64Gbit) maximum address space
Future expansion of the column address can allow for 29 Row & Upper Column + 16 Lower Column address bits = 35 Tera-word = 70 Tera-byte address space.

Figure 7. Data Placement During a Read Transaction^[9, 10, 11, 12, 13]



Notes

- Figure shows a portion of a Read transaction on the HyperBus. CK# of differential clock is shown as dashed line waveform.
- Data is "edge aligned" with the RWDS serving as a read data strobe during read transactions.
- Data is always transferred in full word increments (word granularity transfers).
- Word address increments in each clock cycle. Byte A is between RWDS rising and falling edges and is followed by byte B between RWDS falling and rising edges, of each word.
- Data bits in each byte are always in high to low order with bit 7 on DQ7 and bit 0 on DQ0.

Table 4. Data Bit Placement During Read or Write Transaction

Address Space	Byte Order	Byte Position	Word Data Bit	DQ	Bit Order
Memory	Big-endian	A	15	7	<p>When data is being accessed in memory space: <i>The first byte of each word read or written is the "A" byte and the second is the "B" byte. The bits of the word within the A and B bytes depend on how the data was written. If the word lower address bits 7-0 are written in the A byte position and bits 15-8 are written into the B byte position, or vice versa, they will be read back in the same order.</i></p> <p>So, memory space can be stored and read in either little-endian or big-endian order.</p>
			14	6	
			13	5	
			12	4	
			11	3	
			10	2	
			9	1	
		8	0		
		B	7	7	
			6	6	
			5	5	
			4	4	
			3	3	
			2	2	
	1		1		
	0	0			
	Little-endian	A	7	7	
			6	6	
			5	5	
			4	4	
			3	3	
			2	2	
			1	1	
		0	0		
		B	15	7	
			14	6	
			13	5	
			12	4	
11			3		
10			2		
9	1				
8	0				

Table 4. Data Bit Placement During Read or Write Transaction (Continued)

Address Space	Byte Order	Byte Position	Word Data Bit	DQ	Bit Order
Register	Big-endian	A	15	7	<p>When data is being accessed in register space:</p> <p>During a Read transaction on the HyperBus two bytes are transferred on each clock cycle. The upper order byte A (Word[15:8]) is transferred between the rising and falling edges of RWDS (edge aligned). The lower order byte B (Word[7:0]) is transferred between the falling and rising edges of RWDS.</p> <p>During a write, the upper order byte A (Word[15:8]) is transferred on the CK rising edge and the lower order byte B (Word[7:0]) is transferred on the CK falling edge.</p> <p>So, register space is always read and written in Big-endian order because registers have device dependent fixed bit location and meaning definitions.</p>
			14	6	
			13	5	
			12	4	
			11	3	
			10	2	
			9	1	
			8	0	
		B	7	7	
			6	6	
			5	5	
			4	4	
			3	3	
			2	2	
1	1				
0	0				

Figure 8. Data Placement During a Write Transaction^[14, 15, 16, 17]

Notes

14. Figure shows a portion of a Write transaction on the HyperBus.
15. Data is "center aligned" with the clock during a Write transaction.
16. RWDS functions as a data mask during write data transfers with initial latency. Masking of the first and last byte is shown to illustrate an unaligned 3 byte write of data.
17. RWDS is not driven by the master during write data transfers with zero initial latency. Full data words are always written in this case. RWDS may be driven LOW or left HI-Z by the slave in this case.

3.3 Read Transactions

The HyperBus master begins a transaction by driving CS# LOW while clock is idle. Then the clock begins toggling while Command-Address CA words are transferred.

In CA0, CA[47] = 1 indicates that a Read transaction is to be performed. CA[46] = 0 indicates the memory space is being read or CA[46] = 1 indicates the register space is being read. CA[45] indicates the burst type (wrapped or linear). Read transactions can begin the internal array access as soon as the row and upper column address has been presented in CA0 and CA1 (CA[47:16]). CA2 (CA[15:0]) identifies the target Word address within the chosen row. However, some HyperBus devices may require a minimum time between the end of a prior transaction and the start of a new access. This time is referred to as Read-Write-Recovery time (t_{RWR}). The master interface must start driving CS# LOW only at a time when the CA1 transfer will complete after t_{RWR} is satisfied.

The HyperBus master then continues clocking for a number of cycles defined by the latency count setting in configuration register 0. The initial latency count required for a particular clock frequency is based on RWDS. If RWDS is LOW during the CA cycles, one latency count is inserted. If RWDS is HIGH during the CA cycles, an additional latency count is inserted. Once these latency clocks have been completed the memory starts to simultaneously transition the Read-Write Data Strobe (RWDS) and output the target data.

New data is output edge aligned with every transition of RWDS. Data will continue to be output as long as the host continues to transition the clock while CS# is LOW. However, the HyperRAM device may stop RWDS transitions with RWDS LOW, between the delivery of words, in order to insert latency between words when crossing memory array boundaries.

Wrapped bursts will continue to wrap within the burst length and linear burst will output data in a sequential manner across row boundaries. When a linear burst read reaches the last address in the array, continuing the burst beyond the last address will provide undefined data. Read transfers can be ended at any time by bringing CS# HIGH when the clock is idle.

The clock is not required to be free-running. The clock may remain idle while CS# is HIGH.

Figure 9. Read Transaction with Additional Initial Latency^[18, 19, 20, 21, 22, 23, 24, 25]



Notes

- 18. Transactions are initiated with CS# falling while CK = LOW and CK# = HIGH.
- 19. CS# must return HIGH before a new transaction is initiated.
- 20. CK# is the complement of the CK signal. 3.0 V devices use a single ended clock (CK only), CK# is used with CK on 1.8 V devices to provide a differential clock. CK# of a differential clock is shown as a dashed line waveform.
- 21. Read access array starts once CA[23:16] is captured.
- 22. The read latency is defined by the initial latency value in a configuration register.
- 23. In this read transaction example the initial latency count was set to four clocks.
- 24. In this read transaction a RWDS HIGH indication during CA delays output of target data by an additional four clocks.
- 25. The memory device drives RWDS during read transactions.

Figure 3.1 Read Transaction Without Additional Initial Latency^[26]

3.4 Write Transactions with Initial Latency (Memory Core Write)

The HyperBus master begins a transaction by driving CS# LOW while clock is idle. Then the clock begins toggling while Command-Address CA words are transferred.

In CA0, CA[47] = 0 indicates that a Write transaction is to be performed. CA[46] = 0 indicates the memory space is being written. CA[45] indicates the burst type (wrapped or linear). Write transactions can begin the internal array access as soon as the row and upper column address has been presented in CA0 and CA1 (CA[47:16]). CA2 (CA[15:0]) identifies the target word address within the chosen row. However, some HyperBus devices may require a minimum time between the end of a prior transaction and the start of a new access. This time is referred to as Read-Write-Recovery time (t_{RWR}). The master interface must start driving CS# LOW only at a time when the CA1 transfer will complete after t_{RWR} is satisfied.

The HyperBus master then continues clocking for a number of cycles defined by the latency count setting in configuration register 0. The initial latency count required for a particular clock frequency is based on RWDS. If RWDS is LOW during the CA cycles, one latency count is inserted. If RWDS is HIGH during the CA cycles, an additional latency count is inserted.

Once these latency clocks have been completed the HyperBus master starts to output the target data. Write data is center aligned with the clock edges. The first byte of data in each word is captured by the memory on the rising edge of CK and the second byte is captured on the falling edge of CK.

During the CA clock cycles, RWDS is driven by the memory.

During the write data transfers, RWDS is driven by the host master interface as a data mask. When data is being written and RWDS is HIGH the byte will be masked and the array will not be altered. When data is being written and RWDS is LOW the data will be placed into the array. Because the master is driving RWDS during write data transfers, neither the master nor the HyperRAM device are able to indicate a need for latency within the data transfer portion of a write transaction. The acceptable write data burst length setting is also shown in configuration register 0.

Data will continue to be transferred as long as the HyperBus master continues to transition the clock while CS# is LOW. Legacy format wrapped bursts will continue to wrap within the burst length. Hybrid wrap will wrap once then switch to linear burst starting at the next wrap boundary. Linear burst accepts data in a sequential manner across page boundaries. Write transfers can be ended at any time by bringing CS# HIGH when the clock is idle.

When a linear burst write reaches the last address in the memory array space, continuing the burst will write to the beginning of the address range.

The clock is not required to be free-running. The clock may remain idle while CS# is HIGH.

Notes

26. RWDS is LOW during the CA cycles. In this Read Transaction there is a single initial latency count for read data access because, this read transaction does not begin at a time when additional latency is required by the slave.

Figure 10. Write Transaction with Additional Initial Latency^[27, 28, 29, 30, 31, 32, 33]

Figure 11. Write Transaction Without Additional Initial Latency^[27, 30, 32, 33, 34]

Notes

27. Transactions must be initiated with CK = LOW and CK# = HIGH.
28. CS# must return HIGH before a new transaction is initiated.
29. During Command-Address, RWDS is driven by the memory and indicates whether additional latency cycles are required.
30. In this example, RWDS indicates that additional initial latency cycles are required.
31. At the end of Command-Address cycles, the memory stops driving RWDS to allow the host HyperBus master to begin driving RWDS. The master must drive RWDS to a valid LOW before the end of the initial latency to provide a data mask preamble period to the slave.
32. During data transfer, RWDS is driven by the host to indicate which bytes of data should be either masked or loaded into the array.
33. The figure shows RWDS masking byte A0 and byte B1 to perform an unaligned word write to bytes B0 and A1.
34. In this example, RWDS indicates that there is no additional latency required.

3.5 Write Transactions without Initial Latency (Register Write)

A Write transaction starts with the first three clock cycles providing the Command/Address information indicating the transaction characteristics. CA0 may indicate that a Write transaction is to be performed and also indicates the address space and burst type (wrapped or linear).

Writes without initial latency are used for register space writes. HyperRAM device write transactions with zero latency mean that the CA cycles are followed by write data transfers. Writes with zero initial latency, do not have a turn around period for RWDS. The HyperRAM device will always drive RWDS during the Command-Address period to indicate whether extended latency is required for a transaction that has initial latency. However, the RWDS is driven before the HyperRAM device has received the first byte of CA i.e. before the HyperRAM device knows whether the transaction is a read or write to register space. In the case of a write with zero latency, the RWDS state during the CA period does not affect the initial latency of zero. Since master write data immediately follows the Command-Address period in this case, the HyperRAM device may continue to drive RWDS LOW or may take RWDS to HI-Z during write data transfer. The master must not drive RWDS during Writes with zero latency. Writes with zero latency do not use RWDS as a data mask function. All bytes of write data are written (full word writes).

The first byte of data in each word is presented on the rising edge of CK and the second byte is presented on the falling edge of CK. Write data is center aligned with the clock inputs. Write transfers can be ended at any time by bringing CS# HIGH when clock is idle. The clock is not required to be free-running.

Figure 12. Write Operation without Initial Latency



4. Memory Space

When CA[46] is 0 a read or write transaction accesses the DRAM memory array.

Table 5. Memory Space Address Map

Unit Type	Count	System Word Address Bits	CA Bits	Notes
Dies within 128 Mb device	2	A22	35	CA 35 (A22) = 0, bottom die CA 35 (A22) = 1, top die
Rows within 64 Mb device	8192 (Rows)	A21 - A9	34 - 22	
Row	1 (row)	A8 - A3	21 - 16	512 (word addresses) 1 kbytes
Half-Page	8 (word addresses)	A2 - A0	2 - 0	16 bytes

5. Register Space

When CA[46] is 1 a read or write transaction accesses the Register Space.

Table 6. Register Space Address Map^[35]

Register	System Address	—	—	—	31-27	26-19	18-11	10-3	—	2-0
	CA Bits	47	46	45	44-40	39-32	31-24	23-16	15-8	7-0
Identification Register 0 (read only)	C0h or E0h					00h	00h	00h	00h	00h
Identification Register 1 (read only)	C0h or E0h					00h	00h	00h	00h	01h
Configuration Register 0 Read	C0h or E0h					00h	01h	00h	00h	00h
Configuration Register 0 Write	60h					00h	01h	00h	00h	00h
Configuration Register 1 Read	C0h or E0h					00h	01h	00h	00h	01h
Configuration Register 1 Write	60h					00h	01h	00h	00h	01h

Note

35. CA45 may be either 0 or 1 for either wrapped or linear read. CA45 must be 1 as only linear single word register writes are supported.

5.1 Device Identification Registers

There are two read only, non-volatile, word registers, that provide information on the device selected when CS# is LOW. The device information fields identify:

- Manufacturer
- Type
- Density
 - Row address bit count
 - Column address bit count

Table 7. ID Register 0 Bit Assignments

Bits	Function	Settings (Binary)
15-14	64 Mb	Reserved
	128 Mb	Die Address: 00 = Die 1 01 = Die 2
13	Reserved	0 - default
12-8	Row Address Bit Count	00000 - One Row address bit ... 11111 - Thirty-two row address bits 01100 - 64 Mb 01101 - 128 Mb
7-4	Column Address Bit Count	0000 - One column address bit ... 1111 - Sixteen column address bits
3-0	Manufacturer	0000 - Reserved 0001 - Cypress 0010 to 1111 - Reserved

Table 8. ID Register 1 Bit Assignments

Bits	Function	Settings (Binary)
15-4	Reserved	0000_0000_0000b (default)
3-0	Device Type	0000 - HyperRAM 1.0 0001 to 1111 - Reserved

5.1.1 Density and Row Boundaries

The DRAM array size (density) of the device can be determined from the total number of system address bits used for the row and column addresses as indicated by the Row Address Bit Count and Column Address Bit Count fields in the ID0 register. For example: a 64-Mb HyperRAM device has 9 column address bits and 13 row address bits for a total of 22 word address bits = $2^{22} = 4$ Mwords = 8 MB. The 9 column address bits indicate that each row holds $2^9 = 512$ words = 1 kbytes. The row address bit count indicates there are 8196 rows to be refreshed within each array refresh interval. The row count is used in calculating the refresh interval.

5.2 Register Space Access

Register default values are loaded upon power-up or hardware reset. The registers can be altered at any time while the device is in the standby state.

Loading a register is accomplished with a single 16-bit word write transaction as shown in Figure 13. CA[47] is zero to indicate a write transaction, CA[46] is a one to indicate a register space write, CA[45] is a one to indicate a linear write, lower order bits in the CA field indicate the register address.



Each register is written with a separate single word write transaction. Register write transactions have zero latency, the single word of data immediately follows the Command-Address. RWDS is not driven by the host during the write because RWDS is always driven by the memory during the CA cycles to indicate whether a memory array refresh is in progress. Because a register space write goes directly to a register, rather than the memory array, there is no initial write latency, related to an array refresh that may be in progress. In a register write, RWDS is also not used as a data mask because both bytes of a register are always written and never masked.

Reserved register fields must be written with their default value. Writing reserved fields with other than default values may produce undefined results.

Reading of a register is accomplished with a single 16 bit read transaction with CA[46]=1 to select register space. If more than one word is read, the same register value is repeated in each word read. The CA[45] burst type is “don’t care” because only a single register value is read. The contents of the register is returned in the same manner as reading array data, with one or two latency counts, based on the state of RWDS during the Command-Address period. The latency count is defined in the Configuration Register 0 Read Latency field (CR0[7:4]).

Note: It is recommended to configure all configuration registers in the 128 Mb dual-die stack identically.

Notes

36. The host must not drive RWDS during a write to register space.

37. The RWDS signal is driven by the memory during the Command-Address period based on whether the memory array is being refreshed. This refresh indication does not affect the writing of register data. RWDS is driven immediately after CS# goes LOW, before CA[47:46] are received to indicate that the transaction is a write to register space, for which the RWDS refresh indication is not relevant.

38. The register value is always provided immediately after the CA value and is not delayed by a refresh latency.

39. The the RWDS signal returns to HI-Z after the Command-Address period. Register data is never masked. Both data bytes of the register data are loaded into the selected register.

5.2.1 Configuration Register 0

Configuration Register 0 (CR0) is used to define the power mode and access protocol operating conditions for the HyperRAM device. Configurable characteristics include:

- Wrapped Burst Length (16, 32, 64, or 128-byte aligned and length data group)
- Wrapped Burst Type
 - Legacy wrap (sequential access with wrap around within a selected length and aligned group)
 - Hybrid wrap (Legacy wrap once then linear burst at start of the next sequential group)
- Initial Latency
- Variable Latency
 - Whether an array read or write transaction will use fixed or variable latency. If fixed latency is selected the memory will always indicate a refresh latency and delay the read data transfer accordingly. If variable latency is selected, latency for a refresh is only added when a refresh is required at the same time a new transaction is starting.
- Output Drive Strength
- Deep Power Down Mode

Table 9. Configuration Register 0 Bit Assignments

CR0 Bit	Function	Settings (Binary)
15	Deep Power Down Enable (64 Mb)	1 - Normal operation (default) 0 - Writing 0 to CR[15] causes the device to enter Deep Power Down
	Reserved (128 Mb)	Reserved for 128 Mb dual-die stack
14-12	Drive Strength	000 - 34 ohms (default) 001 - 115 ohms 010 - 67 ohms 011 - 46 ohms 100 - 34 ohms 101 - 27 ohms 110 - 22 ohms 111 - 19 ohms
11-8	Reserved	1 - Reserved (default) Reserved for Future Use. When writing this register, these bits should be set to 1 for future compatibility.
7-4	Initial Latency	0000 - 5 Clock Latency - 133 MHz 0001 - 6 Clock Latency - 166 MHz (default) 0010 - Reserved 0011 - Reserved 0100 - Reserved ... 1101 - Reserved 1110 - 3 Clock Latency - 83 MHz 1111 - 4 Clock Latency - 100 MHz
3	Fixed Latency Enable (64 Mb)	0 - Variable Latency - 1 or 2 times Initial Latency depending on RWDS during CA cycles. 1 - Fixed 2 times Initial Latency (default)
	Reserved (128 Mb)	1 - Fixed 2 times Initial Latency (default)
2	Hybrid Burst Enable	0: Wrapped burst sequences to follow hybrid burst sequencing 1: Wrapped burst sequences in legacy wrapped burst manner (default)
1-0	Burst Length	00 - 128 bytes 01 - 64 bytes 10 - 16 bytes 11 - 32 bytes (default)

5.2.1.1 Wrapped Burst

A wrapped burst transaction accesses memory within a group of words aligned on a word boundary matching the length of the configured group. Wrapped access groups can be configured as 16, 32, 64, or 128 bytes alignment and length. During wrapped transactions, access starts at the Command-Address selected location within the group, continues to the end of the configured word group aligned boundary, then wraps around to the beginning location in the group, then continues back to the starting location. Wrapped bursts are generally used for critical word first instruction or data cache line fill read accesses.

5.2.1.2 Hybrid Burst

The beginning of a hybrid burst will wrap within the target address wrapped burst group length before continuing to the next half-page of data beyond the end of the wrap group. Continued access is in linear burst order until the transfer is ended by returning CS# HIGH. This hybrid of a wrapped burst followed by a linear burst starting at the beginning of the next burst group, allows multiple sequential address cache lines to be filled in a single access. The first cache line is filled starting at the critical word. Then the next sequential line in memory can be read in to the cache while the first line is being processed.

Table 10. CR0[2] Control of Wrapped Burst Sequence

Bit	Default Value	Name
2	1	Hybrid Burst Enable CR[2] = 0: Wrapped burst sequences to follow hybrid burst sequencing CR[2] = 1: Wrapped burst sequences in legacy wrapped burst manner

Table 11. Example Wrapped Burst Sequences^[40]

Burst Selection		Burst Type	Wrap Boundary (bytes)	Start Address (Hex)	Address Sequence (Hex) (Words)
CA[45]	CR0[2:0]				
0	000	Hybrid 128	128 Wrap once then Linear	XXXXXX03	03, 04, 05, 06, 07, 08, 09, 0A, 0B, 0C, 0D, 0E, 0F, 10, 11, 12, 13, 14, 15, 16, 17, 18, 19, 1A, 1B, 1C, 1D, 1E, 1F, 20, 21, 22, 23, 24, 25, 26, 27, 28, 29, 2A, 2B, 2C, 2D, 2E, 2F, 30, 31, 32, 33, 34, 35, 36, 37, 38, 39, 3A, 3B, 3C, 3D, 3E, 3F, 00, 01, 02 (wrap complete, now linear beyond the end of the initial 128 byte wrap group) 40, 41, 42, 43, 44, 45, 46, 47, 48, 49, 4A, 4B, 4C, 4D, 4E, 4F, 50, 51, ...
0	001	Hybrid 64	64 Wrap once then Linear	XXXXXX03	03, 04, 05, 06, 07, 08, 09, 0A, 0B, 0C, 0D, 0E, 0F, 10, 11, 12, 13, 14, 15, 16, 17, 18, 19, 1A, 1B, 1C, 1D, 1E, 1F, 00, 01, 02, (wrap complete, now linear beyond the end of the initial 64 byte wrap group) 20, 21, 22, 23, 24, 25, 26, 27, 28, 29, 2A, 2B, 2C, 2D, 2E, 2F, 30, 31, ...
0	001	Hybrid 64	64 Wrap once then Linear	XXXXXX2E	2E, 2F, 30, 31, 32, 33, 34, 35, 36, 37, 38, 39, 3A, 3B, 3C, 3D, 3E, 3F, 20, 21, 22, 23, 24, 25, 26, 27, 28, 29, 2A, 2B, 2C, 2D, (wrap complete, now linear beyond the end of the initial 64 byte wrap group) 40, 41, 42, 43, 44, 45, 46, 47, 48, 49, 4A, 4B, 4C, 4D, 4E, 4F, 50, 51, ...
0	010	Hybrid 16	16 Wrap once then Linear	XXXXXX02	02, 03, 04, 05, 06, 07, 00, 01, (wrap complete, now linear beyond the end of the initial 16 byte wrap group) 08, 09, 0A, 0B, 0C, 0D, 0E, 0F, 10, 11, 12, ...

Note

40. Linear Burst across die boundary is not supported in 128-Mb dual-die stack.

Table 11. Example Wrapped Burst Sequences^[40] (Continued)

Burst Selection		Burst Type	Wrap Boundary (bytes)	Start Address (Hex)	Address Sequence (Hex) (Words)
CA[45]	CR0[2:0]				
0	010	Hybrid 16	16 Wrap once then Linear	XXXXXX0C	0C, 0D, 0E, 0F, 08, 09, 0A, 0B, (wrap complete, now linear beyond the end of the initial 16 byte wrap group) 10, 11, 12, 13, 14, 15, 16, 17, 18, 19, 1A, ...
0	011	Hybrid 32	32 Wrap once then Linear	XXXXXX0A	0A, 0B, 0C, 0D, 0E, 0F, 00, 01, 02, 03, 04, 05, 06, 07, 08, 09, ...
0	011	Hybrid 32	32 Wrap once then Linear	XXXXXX1E	1E, 1F, 10, 11, 12, 13, 14, 15, 16, 17, 18, 19, 1A, 1B, 1C, 1D, ...
0	100	Wrap 128	128	XXXXXX03	03, 04, 05, 06, 07, 08, 09, 0A, 0B, 0C, 0D, 0E, 0F, 10, 11, 12, 13, 14, 15, 16, 17, 18, 19, 1A, 1B, 1C, 1D, 1E, 1F, 20, 21, 22, 23, 24, 25, 26, 27, 28, 29, 2A, 2B, 2C, 2D, 2E, 2F, 30, 31, 32, 33, 34, 35, 36, 37, 38, 39, 3A, 3B, 3C, 3D, 3E, 3F, 00, 01, 02, ...
0	101	Wrap 64	64	XXXXXX03	03, 04, 05, 06, 07, 08, 09, 0A, 0B, 0C, 0D, 0E, 0F, 10, 11, 12, 13, 14, 15, 16, 17, 18, 19, 1A, 1B, 1C, 1D, 1E, 1F, 00, 01, 02, ...
0	101	Wrap 64	64	XXXXXX2E	2E, 2F, 30, 31, 32, 33, 34, 35, 36, 37, 38, 39, 3A, 3B, 3C, 3D, 3E, 3F, 20, 21, 22, 23, 24, 25, 26, 27, 28, 29, 2A, 2B, 2C, 2D, ...
0	110	Wrap 16	16	XXXXXX02	02, 03, 04, 05, 06, 07, 00, 01, ...
0	110	Wrap 16	16	XXXXXX0C	0C, 0D, 0E, 0F, 08, 09, 0A, 0B, ...
0	111	Wrap 32	32	XXXXXX0A	0A, 0B, 0C, 0D, 0E, 0F, 00, 01, 02, 03, 04, 05, 06, 07, 08, 09, ...
0	111	Wrap 32	32	XXXXXX1E	1E, 1F, 10, 11, 12, 13, 14, 15, 16, 17, 18, 19, 1A, 1B, 1C, 1D, ...
1	XXX	Linear	Linear Burst	XXXXXX03	03, 04, 05, 06, 07, 08, 09, 0A, 0B, 0C, 0D, 0E, 0F, 10, 11, 12, 13, 14, 15, 16, 17, 18, ...

Note

40. Linear Burst across die boundary is not supported in 128-Mb dual-die stack.

5.2.1.3 Initial Latency

Memory Space read and write transactions or Register Space read transactions require some initial latency to open the row selected by the Command-Address. This initial latency is t_{ACC} . The number of latency clocks needed to satisfy t_{ACC} depends on the HyperBus frequency and can vary from 3 to 6 clocks. The value in CR0[7:4] selects the number of clocks for initial latency. The default value is 6 clocks, allowing for operation up to a maximum frequency of 166MHz prior to the host system setting a lower initial latency value that may be more optimal for the system.

In the event a distributed refresh is required at the time a Memory Space read or write transaction or Register Space read transaction begins, the RWDS signal goes HIGH during the Command-Address to indicate that an additional initial latency is being inserted to allow a refresh operation to complete before opening the selected row.

Register Space write transactions always have zero initial latency. RWDS may be HIGH or LOW during the Command-Address period. The level of RWDS during the Command-Address period does not affect the placement of register data immediately after the Command-Address, as there is no initial latency needed to capture the register data. A refresh operation may be performed in the memory array in parallel with the capture of register data.

5.2.1.4 Fixed Latency

A configuration register option bit CR0[3] is provided to make all Memory Space read and write transactions or Register Space read transactions require the same initial latency by always driving RWDS HIGH during the Command-Address to indicate that two initial latency periods are required. This fixed initial latency is independent of any need for a distributed refresh, it simply provides a fixed (deterministic) initial latency for all of these transaction types. The fixed latency option may simplify the design of some HyperBus memory controllers or ensure deterministic transaction performance. Fixed latency is the default POR or reset configuration. The system may clear this configuration bit to disable fixed latency and allow variable initial latency with RWDS driven HIGH only when additional latency for a refresh is required.

Note 128-Mb dual-die stack only supports fixed latency.

5.2.1.5 Drive Strength

DQ signal line loading, length, and impedance vary depending on each system design. Configuration register bits CR0[14:12] provide a means to adjust the DQ[7:0] signal output impedance to customize the DQ signal impedance to the system conditions to minimize high-speed signal behaviors such as overshoot, undershoot, and ringing. The default POR or reset configuration value is 000b to select the mid point of the available output impedance options.

The impedance values shown are typical for both pull-up and pull-down drivers at typical silicon process conditions, nominal operating voltage (1.8 V or 3.0 V) and 50°C. The impedance values may vary by up to $\pm 80\%$ from the typical values depending on the Process, Voltage, and Temperature (PVT) conditions. Impedance will increase with slower process, lower voltage, or higher temperature. Impedance will decrease with faster process, higher voltage, or lower temperature.

Each system design should evaluate the data signal integrity across the operating voltage and temperature ranges to select the best drive strength settings for the operating conditions.

5.2.1.6 Deep Power Down

When the HyperRAM device is not needed for system operation, it may be placed in a very low power consuming mode called Deep Power Down (DPD), by writing 0 to CR0[15]. When CR0[15] is cleared to 0, the device enters the DPD mode within t_{DPDIN} time and all refresh operations stop. The data in RAM is lost, (becomes invalid without refresh) during DPD mode. The next access to the device driving CS# LOW then HIGH, POR, or a reset will cause the device to exit DPD mode. Returning to Standby mode requires t_{DPDOUT} time. For additional details see [Section 6.1.3, Deep Power Down on page 27](#).

Note: The Deep Power Down option is not supported in 128-Mb dual-die stack.

5.2.2 Configuration Register 1

Configuration Register 1 (CR1) is used to define the distributed refresh interval for this HyperRAM device. The core DRAM array requires periodic refresh of all bits in the array. This can be done by the host system by reading or writing a location in each row within a specified time limit. The read or write access copies a row of bits to an internal buffer. At the end of the access the bits in the buffer are written back to the row in memory, thereby recharging (refreshing) the bits in the row of DRAM memory cells.

However, the host system generally has better things to do than to periodically read every row in memory and keep track that each row is visited within the required refresh interval for the entire memory array. HyperRAM devices include self-refresh logic that will refresh rows automatically so that the host system is relieved of the need to refresh the memory. The automatic refresh of a row can only be done when the memory is not being actively read or written by the host system. The refresh logic waits for the end of any active read or write before doing a refresh, if a refresh is needed at that time. If a new read or write begins before the refresh is completed, the memory will drive RWDS HIGH during the Command-Address period to indicate that an additional initial latency time is required at the start of the new access in order to allow the refresh operation to complete before starting the new access.

The required refresh interval for the entire memory array varies with temperature as shown in [Table 12, Array Refresh Interval per Temperature on page 25](#). This is the time within which all rows must be refreshed. Refresh of all rows could be done as a single batch of accesses at the beginning of each interval, in groups (burst refresh) of several rows at a time, spread throughout each interval, or as single row refreshes evenly distributed throughout the interval. The self-refresh logic distributes single row refresh operations throughout the interval so that the memory is not busy doing a burst of refresh operations for a long period, such that the burst refresh would delay host access for a long period.

Table 12. Array Refresh Interval per Temperature

Device Temperature (°C)	Array Refresh Interval (ms)	Array Rows	Recommended t_{CMS} (μ s)
85	64	8192	4
105	16	8192	1

Table 13. Configuration Register 1 Bit Assignments

CR1 Bit	Function	Settings (Binary)
15-2	Reserved	000000h — Reserved (default) Reserved for Future Use. When writing this register, these bits should be cleared to 0 for future compatibility.
1-0	Distributed Refresh Interval	10b — default 4 μ s for Industrial temperature range devices 1 μ s for Industrial Plus temperature range devices 11b — 1.5 times default 00b — 2 times default 01b — 4 times default

The distributed refresh method requires that the host does not do burst transactions that are so long as to prevent the memory from doing the distributed refreshes when they are needed. This sets an upper limit on the length of read and write transactions so that the refresh logic can insert a refresh between transactions. This limit is called the CS# LOW maximum time (t_{CMS}). The t_{CMS} value is determined by the array refresh interval divided by the number of rows in the array, then reducing this calculation by half to ensure that a distributed refresh interval cannot be entirely missed by a maximum length host access starting immediately before a distributed refresh is needed. Because t_{CMS} is set to half the required distributed refresh interval, any series of maximum length host accesses that delay refresh operations will be catching up on refresh operations at twice the rate required by the refresh interval divided by the number of rows.

The host system is required to respect the t_{CMS} value by ending each transaction before violating t_{CMS} . This can be done by host memory controller logic splitting long transactions when reaching the t_{CMS} limit, or by host system hardware or software not performing a single read or write transaction that would be longer than t_{CMS} .

As noted in [Table 12 on page 25](#) the array refresh interval is longer at lower temperatures such that t_{CMS} could be increased to allow longer transactions. The host system can either use the t_{CMS} value from the table for the maximum operating temperature or, may determine the current operating temperature from a temperature sensor in the system in order to set a longer distributed refresh interval.

The host system may also effectively increase the t_{CMS} value by explicitly taking responsibility for performing all refresh and doing burst refresh reading of multiple sequential rows in order to catch up on distributed refreshes missed by longer transactions.

6. Interface States

Table 14 describes the required value of each signal for each interface state.

Table 14. Interface States

Interface State	V_{CC} / V_{CCQ}	CS#	CK, CK#	DQ7-DQ0	RWDS	RESET#
Power-Off	$< V_{LKO}$	X	X	HI-Z	HI-Z	X
Power-On (Cold) Reset	$\geq V_{CC} / V_{CCQ} \text{ min}$	X	X	HI-Z	HI-Z	X
Hardware (Warm) Reset	$\geq V_{CC} / V_{CCQ} \text{ min}$	X	X	HI-Z	HI-Z	L
Interface Standby	$\geq V_{CC} / V_{CCQ} \text{ min}$	H	X	HI-Z	HI-Z	H
Command-Address	$\geq V_{CC} / V_{CCQ} \text{ min}$	L	T	Master Output Valid	X	H
Read Initial Access Latency (data bus turn around period)	$\geq V_{CC} / V_{CCQ} \text{ min}$	L	T	HI-Z	L	H
Write Initial Access Latency (RWDS turn around period)	$\geq V_{CC} / V_{CCQ} \text{ min}$	L	T	HI-Z	HI-Z	H
Read data transfer	$\geq V_{CC} / V_{CCQ} \text{ min}$	L	T	Slave Output Valid	Slave Output Valid X or T	H
Write data transfer with Initial Latency	$\geq V_{CC} / V_{CCQ} \text{ min}$	L	T	Master Output Valid	Master Output Valid X or T	H
Write data transfer without Initial Latency ^[41]	$\geq V_{CC} / V_{CCQ} \text{ min}$	L	T	Master Output Valid	Slave Output L or HI-Z	H
Active Clock Stop ^[42]	$\geq V_{CC} / V_{CCQ} \text{ min}$	L	Idle	Master or Slave Output Valid or HI-Z	X	H
Deep Power Down ^[42]	$\geq V_{CC} / V_{CCQ} \text{ min}$	H	X or T	Slave Output HI-Z	HI-Z	H

Notes

41. Writes without initial latency (with zero initial latency), do not have a turn around period for RWDS. The HyperRAM device will always drive RWDS during the Command-Address period to indicate whether extended latency is required. Since master write data immediately follows the Command-Address period the HyperRAM device may continue to drive RWDS LOW or may take RWDS to HI-Z. The master must not drive RWDS during Writes with zero latency. Writes with zero latency do not use RWDS as a data mask function. All bytes of write data are written (full word writes).

42. Active Clock Stop is described in Section 6.1.2, Active Clock Stop on page 27. DPD is described in Section 6.1.3, Deep Power Down on page 27.

Legend

L = V_{IL}

H = V_{IH}

X = either V_{IL} or V_{IH}

L/H = rising edge

H/L = falling edge

T = Toggling during information transfer

Idle = CK is LOW and CK# is HIGH.

Valid = all bus signals have stable L or H level

6.1 Power Conservation Modes

6.1.1 Interface Standby

Standby is the default, low-power, state for the interface while the device is not selected by the host for data transfer (CS# = HIGH). All inputs, and outputs other than CS# and RESET# are ignored in this state.

6.1.2 Active Clock Stop

The Active Clock Stop mode reduces device interface energy consumption to the I_{CC6} level during the data transfer portion of a read or write operation. The device automatically enables this mode when clock remains stable for $t_{ACC} + 30$ ns. While in Active Clock Stop mode, read data is latched and always driven onto the data bus. I_{CC6} shown in [Section 7.4, DC Characteristics on page 30](#).

Active Clock Stop mode helps reduce current consumption when the host system clock has stopped to pause the data transfer. Even though CS# may be LOW throughout these extended data transfer cycles, the memory device host interface will go into the Active Clock Stop current level at $t_{ACC} + 30$ ns. This allows the device to transition into a lower current mode if the data transfer is stalled. Active read or write current will resume once the data transfer is restarted with a toggling clock. The Active Clock Stop mode must not be used in violation of the t_{CSM} limit. CS# must go HIGH before t_{CSM} is violated.

6.1.3 Deep Power Down

In the Deep Power Down (DPD) mode, current consumption is driven to the lowest possible level (i_{DPD}). DPD mode is entered by writing a 0 to CR0[15]. The device reduces power within t_{DPDIN} time and all refresh operations stop. The data in Memory Space is lost, (becomes invalid without refresh) during DPD mode. The next access to the device, driving CS# LOW then HIGH, will cause the device to exit DPD mode. A read or write transaction used to drive CS# LOW then HIGH to exit DPD mode is a dummy transaction that is ignored by the device. Also, POR, or a hardware reset will cause the device to exit DPD mode. Only the CS# and RESET# signals are monitored during DPD mode. Returning to Standby mode following a dummy transaction or reset requires t_{DPDOUT} time. Returning to Standby mode following a POR requires t_{VCS} time, as with any other POR. Following the exit from DPD due to any of these events, the device is in the same state as following POR.

Table 15. Deep Power Down Timing Parameters

Parameter	Description	Min	Max	Unit
t_{DPDIN}	Deep Power Down CR0[15]=0 register write to DPD power level	10	–	μ s
t_{DPDCSL}	Length of CS# LOW period to cause an exit from Deep Power Down	200	–	ns
t_{DPDOUT}	CS# LOW then HIGH to Standby wakeup time	–	150	μ s

Figure 14. Deep Power Down Entry Timing



Figure 15. Deep Power Down CS# Exit Timing

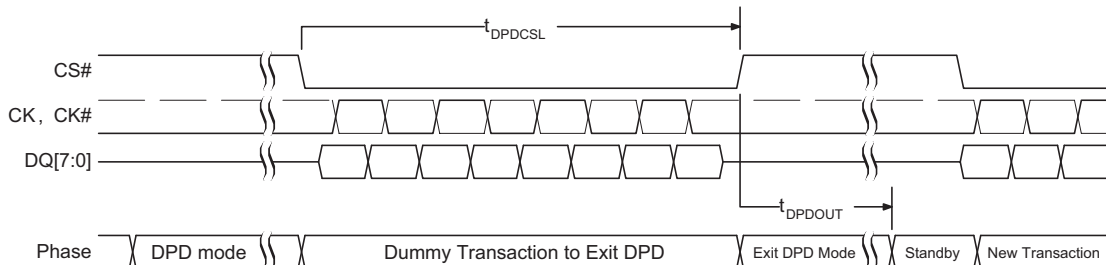

Notes

43. The Deep Power Down option is not supported in 128-Mb dual-die stack.

7. Electrical Specifications

7.1 Absolute Maximum Ratings

Storage Temperature Plastic Packages	-65 °C to +150 °C
Ambient Temperature with Power Applied	-65°C to +115 °C
Voltage with Respect to Ground	
All signals ^[44]	-0.5V to +(V _{CC} + 0.5V)
Output Short Circuit Current ^[45]	100 mA
V _{CC}	-0.5V to +4.0V

7.1.1 Input Signal Overshoot

During DC conditions, input or I/O signals should remain equal to or between V_{SS} and V_{DD}. During voltage transitions, inputs or I/Os may negative overshoot V_{SS} to -1.0V or positive overshoot to V_{DD} +1.0V, for periods up to 20 ns.

Figure 16. Maximum Negative Overshoot Waveform



Figure 17. Maximum Positive Overshoot Waveform



Notes

44. Minimum DC voltage on input or I/O signal is -1.0V. During voltage transitions, input or I/O signals may undershoot V_{SS} to -1.0V for periods of up to 20 ns. See [Figure 16](#). Maximum DC voltage on input or I/O signals is V_{CC} +1.0V. During voltage transitions, input or I/O signals may overshoot to V_{CC} +1.0V for periods up to 20 ns. See [Figure 17](#).
45. No more than one output may be shorted to ground at a time. Duration of the short circuit should not be greater than one second.
46. Stresses above those listed under [Absolute Maximum Ratings](#) may cause permanent damage to the device. This is a stress rating only; functional operation of the device at these or any other conditions above those indicated in the operational sections of this data sheet is not implied. Exposure of the device to absolute maximum rating conditions for extended periods may affect device reliability.

7.2 Latchup Characteristics

Table 7.1 Latchup Specification^[47]

Description	Min	Max	Unit
Input voltage with respect to V_{SSQ} on all input only connections	- 1.0	$V_{CCQ} + 1.0$	V
Input voltage with respect to V_{SSQ} on all I/O connections	-1.0	$V_{CCQ} + 1.0$	V
V_{CCQ} Current	-100	+100	mA

Note

47. Excludes power supplies V_{CC}/V_{CCQ} . Test conditions: $V_{CC} = V_{CCQ} = 1.8$ V, one connection at a time tested, connections not being tested are at V_{SS} .

7.3 Operating Ranges

Operating ranges define those limits between which the functionality of the device is guaranteed.

7.3.1 Temperature Ranges

Parameter	Symbol	Device	Spec		Unit
			Min	Max	
Ambient Temperature	T_A	Industrial (I)	-40	85	°C
		Industrial Plus (V)	-40	105	
		Automotive, AEC-Q100 Grade 3 (A)	-40	85	
		Automotive, AEC-Q100 Grade 2 (B)	-40	105	

7.3.2 Power Supply Voltages

V_{CC} and V_{CCQ}	1.7 V to 1.95 V
V_{CC} and V_{CCQ}	2.7 V to 3.6 V

7.4 DC Characteristics

Table 16. DC Characteristics (CMOS Compatible)

Parameter	Description	Test Conditions	64 Mb			128 Mb			Unit
			Min	Typ ^[48]	Max	Min	Typ ^[48]	Max	
I_{LI}	Input Leakage Current 3.0 V Device Reset Signal HIGH Only	$V_{IN} = V_{SS}$ to V_{CC} , $V_{CC} = V_{CC}$ max	-	-	-0.1	-	-	-0.2	μ A
I_{LI}	Input Leakage Current 1.8 V Device Reset Signal HIGH Only	$V_{IN} = V_{SS}$ to V_{CC} , $V_{CC} = V_{CC}$ max	-	-	-0.1	-	-	-0.2	μ A
I_{LI}	Input Leakage Current 3.0 V Device Reset Signal LOW Only ^[49]	$V_{IN} = V_{SS}$ to V_{CC} , $V_{CC} = V_{CC}$ max	-	-	+20.0	-	-	+40.0	μ A
I_{LI}	Input Leakage Current 1.8 V Device Reset Signal LOW Only ^[49]	$V_{IN} = V_{SS}$ to V_{CC} , $V_{CC} = V_{CC}$ max	-	-	+20.0	-	-	+40.0	μ A
I_{CC1}	V_{CC} Active Read Current	$CS\# = V_{IL}$, @166 MHz, $V_{CC} = 1.9V$	-	20	60	-	29	72	mA
		$CS\# = V_{IL}$, @100 MHz, $V_{CC} = 3.6V$	-	20	35	-	32	47	mA
I_{CC2}	V_{CC} Active Write Current	$CS\# = V_{IL}$, @166 MHz, $V_{CC} = 1.9V$	-	15	60	-	23	72	mA
		$CS\# = V_{IL}$, @100 MHz, $V_{CC} = 3.6V$	-	15	35	-	27	47	mA
I_{CC4I}	V_{CC} Standby Current for Industrial (-40 °C to +85 °C)	$CS\# = V_{IH}$, $V_{CC} = V_{CC}$ max	-	135	200	-	286	400	μ A
I_{CC4IP}	V_{CC} Standby Current for Industrial Plus (-40 °C to +105 °C)	$CS\# = V_{IH}$, $V_{CC} = V_{CC}$ max	-	135	300	-	312	600	μ A
I_{CC5}	Reset Current	$CS\# = V_{IH}$, $RESET\# = V_{IL}$, $V_{CC} = V_{CC}$ max	-	10	20	-	20	40	mA
I_{CC6I}	Active Clock Stop Current for Industrial (-40 °C to +85 °C)	$CS\# = V_{IL}$, $RESET\# = V_{IH}$, $V_{CC} = V_{CC}$ max	-	5.3	8	-	11	16	mA
I_{CC6IP}	Active Clock Stop Current for Industrial Plus(-40 °C to +105 °C)	$CS\# = V_{IL}$, $RESET\# = V_{IH}$, $V_{CC} = V_{CC}$ max	-	5.3	12	-	12	24	mA
I_{CC7}	V_{CC} Current during power up ^[48]	$CS\# = V_{IH}$, $V_{CC} = V_{CC}$ max, $V_{CC} = V_{CCQ} = 1.95V$ or 3.6V	-	-	35	-	-	70	mA
I_{DPD}	Deep Power Down Current 3.0 V 85 °C	$CS\# = V_{IH}$, $V_{CC} = 3.6V$, $T_A = 85$ °C	-	-	20	-	-	N/A	μ A
I_{DPD}	Deep Power Down Current 1.8 V 85 °C	$CS\# = V_{IH}$, $V_{CC} = 1.9V$, $T_A = 85$ °C	-	-	10	-	-	N/A	μ A
I_{DPD}	Deep Power Down Current 3.0 V 105 °C	$CS\# = V_{IH}$, $V_{CC} = 3.6V$, $T_A = 105$ °C	-	-	40	-	-	N/A	μ A

Notes

48. Not 100% tested.

 49. RESET# LOW initiates exits from DPD mode and initiates the draw of I_{CC5} reset current, making I_{LI} during Reset# LOW insignificant.

Table 16. DC Characteristics (CMOS Compatible) (Continued)

Parameter	Description	Test Conditions	64 Mb			128 Mb			Unit
			Min	Typ ^[48]	Max	Min	Typ ^[48]	Max	
I _{DPD}	Deep Power Down Current 1.8 V 105°C	CS# = V _{IH} , V _{CC} = 1.9V, T _A = 105 °C	–	–	20	–	–	N/A	μA
V _{IL}	Input LOW Voltage		–0.5	–	0.3 x V _{CC}	–0.5	–	0.3 x V _{CC}	V
V _{IH}	Input HIGH Voltage		0.7 x V _{CC}	–	V _{CC} + 0.3	0.7 x V _{CC}	–	V _{CC} + 0.3	V
V _{OL}	Output LOW Voltage	I _{OL} = 100 μA for DQ[7:0]	–	–	0.15 x V _{CC}	–	–	0.15 x V _{CC}	V
V _{OH}	Output HIGH Voltage	I _{OH} = 100 μA for DQ[7:0]	–	0.85 x V _{CC}	–	–	0.85 x V _{CC}	–	V

Notes

48. Not 100% tested.

 49. RESET# LOW initiates exits from DPD mode and initiates the draw of I_{CC5} reset current, making I_{L1} during Reset# LOW insignificant.

7.4.1 HIGHCapacitance Characteristics

Table 7.2 1.8 V Capacitive Characteristics^[50, 51, 52]

Description	Parameter	64 Mb		128 Mb		Unit
		Min	Max	Min	Max	
Input Capacitance (CK, CK#, CS#)	CI	3	4.5	6	9	pF
Delta Input Capacitance (CK, CK#)	CID	–	0.25	–	0.5	pF
Output Capacitance (RWDS)	CO	3	4	6	8	pF
IO Capacitance (DQx)	CIO	3	4	6	8	pF
IO Capacitance Delta (DQx)	CIOD	–	0.5	–	1	pF

Notes

50. These values are guaranteed by design and are tested on a sample basis only.

 51. Contact capacitance is measured according to JEP147 procedure for measuring capacitance using a vector network analyzer. V_{CC}, V_{CCQ} are applied and all other signals (except the signal under test) floating. DQ's should be in the HI-Z state.

52. Note that the capacitance values for the CK, CK#, RWDS and DQx signals must have similar capacitance values to allow for signal propagation time matching in the system. The capacitance value for CS# is not as critical because there are no critical timings between CS# going active (LOW) and data being presented on the DQs bus.

Table 7.3 3.0 V Capacitive Characteristics^[53, 54, 55]

Description	Parameter	64 Mb		128 Mb		Unit
		Min	Max	Min	Max	
Input Capacitance (CK, CS#)	CI	3	4.5	6	9	pF
Output Capacitance (RWDS)	CO	3	4	6	8	pF
IO Capacitance (DQx)	CIO	3	4	6	8	pF
IO Capacitance Delta (DQx)	CIOD	–	0.5	–	1	pF

Notes

53. These values are guaranteed by design and are tested on a sample basis only.

 54. Contact capacitance is measured according to JEP147 procedure for measuring capacitance using a vector network analyzer. V_{CC}, V_{CCQ} are applied and all other signals (except the signal under test) floating. DQ's should be in the HI-Z state.

55. The capacitance values for the CK, RWDS and DQx signals must have similar capacitance values to allow for signal propagation time matching in the system. The capacitance value for CS# is not as critical because there are no critical timings between CS# going active (LOW) and data being presented on the DQs bus.

7.5 Power-Up Initialization

HyperRAM products include an on-chip voltage sensor used to launch the power-up initialization process. V_{CC} and V_{CCQ} must be applied simultaneously. When the power supply reaches a stable level at or above $V_{CC}(\text{min})$, the device will require t_{VCS} time to complete its self-initialization process.

The device must not be selected during power-up. CS# must follow the voltage applied on V_{CCQ} until $V_{CC}(\text{min})$ is reached during power-up, and then CS# must remain HIGH for a further delay of t_{VCS} . A simple pull-up resistor from V_{CCQ} to Chip Select (CS#) can be used to insure safe and proper power-up.

If RESET# is LOW during power up, the device delays start of the t_{VCS} period until RESET# is HIGH. The t_{VCS} period is used primarily to perform refresh operations on the DRAM array to initialize it.

When initialization is complete, the device is ready for normal operation.

Figure 18. Power-up with RESET# HIGH



Figure 19. Power-up with RESET# LOW



Table 17. Power Up and Reset Parameters^[56, 57, 58]

Parameter	Description	Min	Max	Unit
V_{CC}	1.8 V V_{CC} Power Supply	1.7	1.95	V
V_{CC}	3.0 V V_{CC} Power Supply	2.7	3.6	V
t_{VCS}	V_{CC} and $V_{CCQ} \geq$ minimum and RESET# HIGH to first access	–	150	μs

Notes

- 56. Bus transactions (read and write) are not allowed during the power-up reset time (t_{VCS}).
- 57. V_{CCQ} must be the same voltage as V_{CC} .
- 58. V_{CC} ramp rate may be non-linear.

7.6 Power Down

HyperRAM devices are considered to be powered-off when the core power supply (V_{CC}) drops below the V_{CC} Lock-Out voltage (V_{LKO}). During a power supply transition down to the V_{SS} level, V_{CCQ} should remain less than or equal to V_{CC} . At the V_{LKO} level, the HyperRAM device will have lost configuration or array data.

V_{CC} must always be greater than or equal to V_{CCQ} ($V_{CC} \geq V_{CCQ}$).

During Power-Down or voltage drops below V_{LKO} , the core power supply voltages must also drop below V_{CC} Reset (V_{RST}) for a Power Down period (t_{PD}) for the part to initialize correctly when the power supply again rises to V_{CC} minimum. See Figure 20.

If during a voltage drop the V_{CC} stays above V_{LKO} the part will stay initialized and will work correctly when V_{CC} is again above V_{CC} minimum. If V_{CC} does not go below and remain below V_{RST} for greater than t_{PD} , then there is no assurance that the POR process will be performed. In this case, a hardware reset will be required ensure the HyperBus device is properly initialized.

Figure 20. Power Down or Voltage Drop



The following section describes HyperRAM device dependent aspects of power down specifications.

Table 18. 1.8 V Power-Down Voltage and Timing^[59]

Symbol	Parameter	Min	Max	Unit
V_{CC}	V_{CC} Power Supply	1.7	1.95	V
V_{LKO}	V_{CC} Lock-out below which re-initialization is required	1.7	–	V
V_{RST}	V_{CC} LOW Voltage needed to ensure initialization will occur	0.8	–	V
t_{PD}	Duration of $V_{CC} \leq V_{RST}$	30	–	μs

Note

59. V_{CC} ramp rate can be non-linear.

Table 19. 3.0 V Power-Down Voltage and Timing^[60]

Symbol	Parameter	Min	Max	Unit
V_{CC}	V_{CC} Power Supply	2.7	3.6	V
V_{LKO}	V_{CC} Lock-out below which re-initialization is required	2.7	–	V
V_{RST}	V_{CC} LOW Voltage needed to ensure initialization will occur	0.8	–	V
t_{PD}	Duration of $V_{CC} \leq V_{RST}$	50	–	μs

Note

60. V_{CC} ramp rate can be non-linear.

7.7 Hardware Reset

The RESET# input provides a hardware method of returning the device to the standby state.

During t_{RPH} the device will draw I_{CC5} current. If RESET# continues to be held LOW beyond t_{RPH} , the device draws CMOS standby current (I_{CC4}). While RESET# is LOW (during t_{RP}), and during t_{RPH} , bus transactions are not allowed.

A hardware reset will:

- cause the configuration registers to return to their default values,
- halt self-refresh operation while RESET# is LOW,
- and force the device to exit the Deep Power Down state.

After RESET# returns HIGH, the self-refresh operation will resume. Because self-refresh operation is stopped during RESET# LOW, and the self-refresh row counter is reset to its default value, some rows may not be refreshed within the required array refresh interval per [Table 12 on page 25](#). This may result in the loss of DRAM array data during or immediately following a hardware reset. The host system should assume DRAM array data is lost after a hardware reset and reload any required data.

Figure 21. Hardware Reset Timing Diagram



Table 20. Power Up and Reset Parameters

Parameter	Description	Min	Max	Unit
t_{RP}	RESET# Pulse Width	200	–	ns
t_{RH}	Time between RESET# (HIGH) and CS# (LOW)	200	–	ns
t_{RPH}	RESET# LOW to CS# LOW	400	–	ns

8. Timing Specifications

The following section describes HyperRAM device dependent aspects of timing specifications.

8.1 Key to Switching Waveforms



8.2 AC Test Conditions

Figure 22. Test Setup

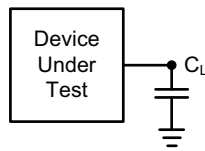

Table 21. Test Specification^[63]

Parameter	All Speeds	Units
Output Load Capacitance, C_L	20	pF
Minimum Input Rise and Fall Slew Rates ^[62]	2.0	V/ns
Input Pulse Levels	0.0- V_{CCQ}	V
Input timing measurement reference levels	$V_{CCQ}/2$	V
Output timing measurement reference levels	$V_{CCQ}/2$	V

Notes

62. All AC timings assume an input slew rate of 2V/ns. CK/CK# differential slew rate of at least 4V/ns.

63. Input and output timing is referenced to $V_{CCQ}/2$ or to the crossing of CK/CK#.

Figure 23. Input Waveforms and Measurement Levels^[61]

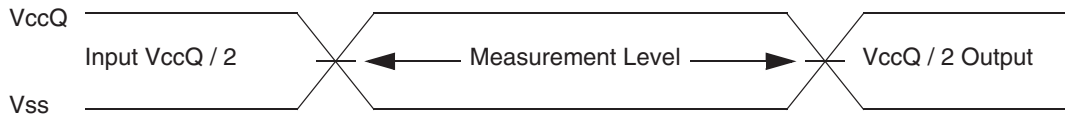

Note

61. Input timings for the differential CK/CK# pair are measured from clock crossings.

8.3 AC Characteristics

8.3.1 Read Transactions

Table 22. HyperRAM Specific 1.8 V Read Timing Parameters

Parameter	Symbol	166 MHz		133 MHz		100 MHz		Unit
		Min	Max	Min	Max	Min	Max	
Chip Select HIGH Between Transactions	t_{CSHI}	6	–	7.5	–	10.0	–	ns
HyperRAM Read-Write Recovery Time	t_{RWR}	36	–	37.5	–	40	–	ns
Chip Select Setup to next CK Rising Edge	t_{CSS}	3	–	3	–	3	–	ns
Data Strobe Valid	t_{DSV}	–	12	–	12	–	12	ns
Input Setup	t_{IS}	0.6	–	0.8	–	1.0	–	ns
Input Hold	t_{IH}	0.6	–	0.8	–	1.0	–	ns
HyperRAM Read Initial Access Time	t_{ACC}	36	–	37.5	–	40	–	ns
Clock to DQs Low Z	t_{DQLZ}	0	–	0	–	0	–	ns
CK transition to DQ Valid (64 Mb)	t_{CKD}	1	5.5	1	5.5	1	5.5	ns
CK transition to DQ Valid (128 Mb)			6.0		6.0		6.0	
CK transition to DQ Invalid (64 Mb)	t_{CKDI}	0	4.6	0	4.5	0	4.3	ns
CK transition to DQ Invalid (128 Mb)			5.6		5.5		5.3	
Data Valid (t_{DV} min = the lessor of: t_{CKHP} min - t_{CKD} max + t_{CKDI} max) or t_{CKHP} min - t_{CKD} min + t_{CKDI} min)	t_{DV}	1.7	–	2.375	–	3.3	–	ns
CK transition to RWDS valid (64 Mb)	t_{CKDS}	1	5.5	1	5.5	1	5.5	ns
CK transition to RWDS valid (128 Mb)			6.0		6.0		6.0	
RWDS transition to DQ Valid	t_{DSS}	-0.45	+0.45	-0.6	+0.6	-0.8	+0.8	ns
RWDS transition to DQ Invalid	t_{DSH}	-0.45	+0.45	-0.6	+0.6	-0.8	+0.8	ns
Chip Select Hold After CK Falling Edge	t_{CSH}	0	–	0	–	0	–	ns
Chip Select Inactive to RWDS HI-Z	t_{DSZ}	–	6	–	6	–	6	ns
Chip Select Inactive to DQ HI-Z	t_{OZ}	–	6	–	6	–	6	ns
HyperRAM Chip Select Maximum LOW Time - Industrial Temperature	t_{CSM}	-	4.0	-	4.0	-	4.0	us
HyperRAM Chip Select Maximum LOW Time - Industrial Plus Temperature		-	1.0	-	1.0	-	1.0	us
Refresh Time	t_{RFH}	36	–	37.5	–	40	–	ns

Table 23. HyperRAM Specific 3.0 V Read Timing Parameters

Parameter	Symbol	100 MHz		Unit
		Min	Max	
Chip Select HIGH Between Transactions	t_{CSHI}	10.0	–	ns
HyperRAM Read-Write Recovery Time	t_{RWR}	40	-	ns
Chip Select Setup to next CK Rising Edge	t_{CSS}	3	–	ns
Data Strobe Valid	t_{DSV}	–	12	ns
Input Setup	t_{IS}	1.0	–	ns
Input Hold	t_{IH}	1.0	–	ns
HyperRAM Read Initial Access Time	t_{ACC}	40	–	ns
Clock to DQs Low Z	t_{DQLZ}	0	–	ns
HyperRAM CK transition to DQ Valid (64 Mb)	t_{CKD}	1	7	ns
HyperRAM CK transition to DQ Valid (128 Mb)			8	
HyperRAM CK transition to DQ Invalid (64 Mb)	t_{CKDI}	0.5	5.2	ns
HyperRAM CK transition to DQ Invalid (128 Mb)			6.2	
Data Valid ($t_{DV} \text{ min} = \text{the lesser of:}$ $t_{CKHP} \text{ min} - t_{CKD} \text{ max} + t_{CKDI} \text{ max}$) or $t_{CKHP} \text{ min} - t_{CKD} \text{ min} + t_{CKDI} \text{ min}$)	t_{DV}	2.7		ns
CK transition to RWDS valid (64 Mb)	t_{CKDS}	1	7	ns
CK transition to RWDS valid (128 Mb)			8	
RWDS transition to DQ Valid	t_{DSS}	-0.8	+0.8	ns
RWDS transition to DQ Invalid	t_{DSH}	-0.8	+0.8	ns
Chip Select Hold After CK Falling Edge	t_{CSH}	0	–	ns
Chip Select Inactive to RWDS HI-Z	t_{DSZ}	–	7	ns
Chip Select Inactive to DQ HI-Z	t_{OZ}	–	7	ns
HyperRAM Chip Select Maximum LOW Time - Industrial Temperature	t_{CSM}	-	4.0	us
HyperRAM Chip Select Maximum LOW Time - Industrial Plus Temperature		-	1.0	us
Refresh Time	t_{RFH}	40	–	ns

Figure 24. Read Timing Diagram — No Additional Latency Required



8.3.2 Write Transactions

Table 24. 1.8 V Write Timing Parameters

Parameter	Symbol	166 MHz		133 MHz		100 MHz		Unit
		Min	Max	Min	Max	Min	Max	
Read-Write Recovery Time	t_{RWR}	36	–	37.5	–	40	–	ns
Access Time	t_{ACC}	36	–	37.5	–	40	–	ns
Refresh Time	t_{RFH}	36	–	37.5	–	40	–	ns
Chip Select Maximum LOW Time – Industrial Temperature	t_{CSM}	–	4.0	–	4.0	–	4.0	μ s
Chip Select Maximum LOW Time – Industrial Plus Temperature		–	1.0	–	1.0	–	1.0	μ s
RWDS Data Mask Valid	t_{DMV}	0	–	0	–	0	–	ns

Table 25. 3.0 V Write Timing Parameters

Parameter	Symbol	100 MHz		Unit
		Min	Max	
Read-Write Recovery Time	t_{RWR}	40	–	ns
Access Time	t_{ACC}	40	–	ns
Refresh Time	t_{RFH}	40	–	ns
Chip Select Maximum LOW Time – Industrial Temperature	t_{CSM}	–	4.0	μ s
Chip Select Maximum LOW Time – Industrial Plus Temperature		–	1.0	μ s
RWDS Data Mask Valid	t_{DMV}	0	–	ns

Note

64. Refer to Table 23 for parameters that are shown in the timing diagram but not listed in this table.

Figure 25. Write Timing Diagram — No Additional Latency



9. Physical Interface

9.1 FBGA 24-Ball 5 x 5 Array Footprint

HyperRAM devices are provided in Fortified Ball Grid Array (FBGA), 1 mm pitch, 24-ball, 5 x 5 ball array footprint, with 6mm x 8mm body.

Figure 26. 24-Ball FBGA, 6 x 8 mm, 5x5 Ball Footprint, Top View^[65, 66]



Notes

- 65. B1 is assigned to CK# on the 1.8 V device.
- 66. B1 is a RFU on the 3.0 V device.

9.2 Physical Diagrams

9.2.1 Fortified Ball Grid Array 24-ball 6 x 8 x 1.0 mm (VAA024)



10. DDR Center Aligned Read Strobe (DCARS) Functionality

The HyperRAM device offers an optional feature that enables independent skewing (phase shifting) of the RWDS signal with respect to the read data outputs. This feature is provided in certain devices, based on the Ordering Part Number (OPN).

When the DDR Center Aligned Read Strobe (DCARS) feature is provided, a second differential Phase Shifted Clock input PSC/PSC# is used as the reference for RWDS edges instead of CK/CK#. The second clock is generally a copy of CK/CK# that is phase shifted 90 degrees to place the RWDS edges centered within the DQ signals valid data window. However, other degrees of phase shift between CK/CK# and PSC/PSC# may be used to optimize the position of RWDS edges within the DQ signals valid data window so that RWDS provides the desired amount of data setup and hold time in relation to RWDS edges.

PSC/PSC# is not used during a write transaction. PSC and PSC# may be driven LOW and HIGH respectively or, both may be driven LOW during write transactions.

The PSC/PSC# differential clock is used only in HyperBus devices with 1.8 V nominal core and I/O voltage. HyperBus devices with 3 V nominal core and I/O voltage use only PSC as a single-ended clock.

10.1 HyperRAM Products with DCARS Signal Descriptions

Figure 27. HyperBus Product with DCARS Signal Diagram

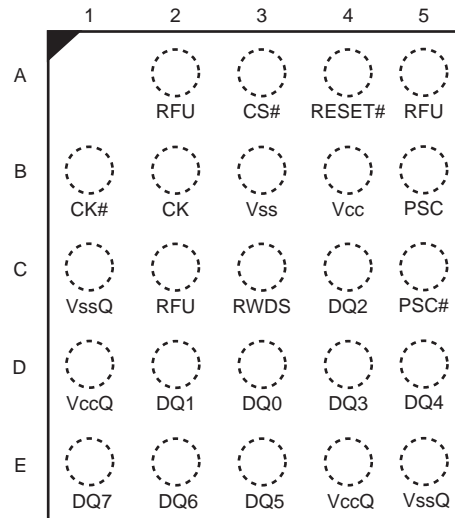

Table 26. Signal Descriptions

Symbol	Type	Description
CS#	Input	Chip Select. HyperBus transactions are initiated with a HIGH to LOW transition. HyperBus transactions are terminated with a LOW to HIGH transition.
CK, CK#	Input	Differential Clock. Command-Address/Data information is input or output with respect to the crossing of the CK and CK# signals. CK# is not used on the 3.0 V device, only a single ended CK is used.
PSC, PSC#	Input	Phase Shifted Clock. PSC/PSC# allows independent skewing of the RWDS signal with respect to the CK/CK# inputs. PSC# is only used on the 1.8 V device. PSC (and PSC#) may be driven HIGH and LOW respectively or both may be driven LOW during write transactions.
RWDS	Output	Read-Write Data Strobe. Data bytes output during read transactions are aligned with RWDS based on the phase shift from CK, CK# to PSC, PSC#. PSC, PSC# cause the transitions of RWDS, thus the phase shift from CK, CK# to PSC, PSC# is used to place RWDS edges within the data valid window. RWDS is an input during write transactions to function as a data mask. At the beginning of all bus transactions RWDS is an output and indicates whether additional initial latency count is required (1 = additional latency count, 0 = no additional latency count).
DQ[7:0]	Input/Output	Data Input/Output. Command-Address/Data information is transferred on these DQs during Read and Write transactions.
RESET#	Input	Hardware RESET. When LOW the device will self initialize and return to the idle state. RWDS and DQ[7:0] are placed into the HI-Z state when RESET# is LOW. RESET# includes a weak pull-up, if RESET# is left unconnected it will be pulled up to the HIGH state.
V _{CC}	Power Supply	Power.
V _{CCQ}	Power Supply	Input/Output Power.
V _{SS}	Power Supply	Ground.
V _{SSQ}	Power Supply	Input/Output Ground.

10.2 HyperRAM Products with DCARS — FBGA 24-ball, 5 x 5 Array Footprint

Figure 28. 24-ball FBGA, 5 x 5 Ball Footprint, Top View^[67, 68]



10.3 HyperRAM Memory with DCARS Timing

The illustrations and parameters shown here are only those needed to define the DCARS feature and show the relationship between the Phase Shifted Clock, RWDS, and data.

Figure 29. HyperRAM Memory DCARS Timing Diagram^[69, 70, 71, 72]

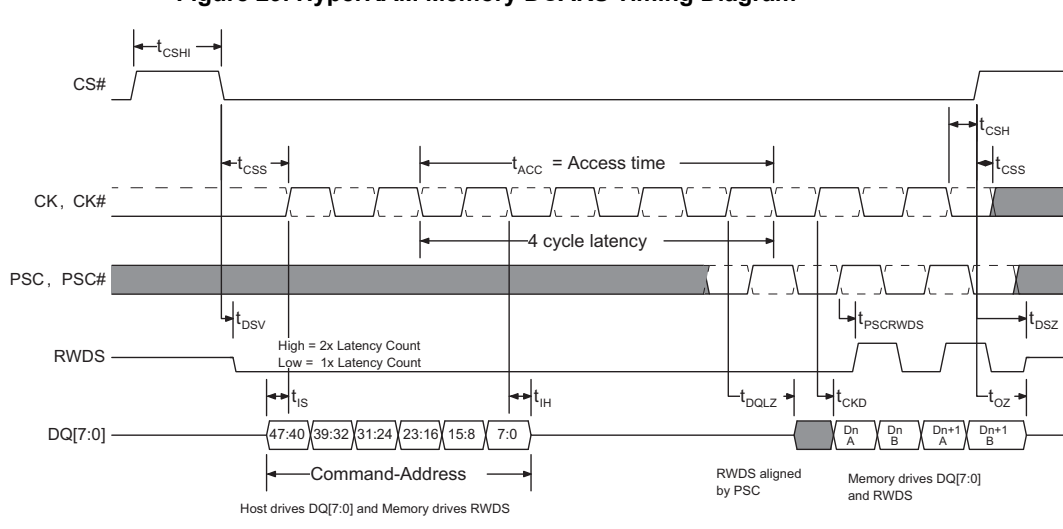

Notes

- 67. B1 is an RFU on the 3.0 V device and is assigned to CK# on the 1.8 V device.
- 68. C5 is an RFU on the 3.0 V device and is assigned to PSC# on the 1.8 V device.
- 69. Transactions must be initiated with CK = LOW and CK# = HIGH. CS# must return HIGH before a new transaction is initiated.
- 70. CK# and PSC# are only used on the 1.8 V device. The 3 V device uses a single ended CK and PSC input.
- 71. The memory drives RWDS during read transactions.
- 72. This example demonstrates a latency code setting of four clocks and no additional initial latency required.

Figure 30. DCARS Data Valid Timing^[73, 74, 75, 76]

Table 27. DCARS Read Timings (3.0 V)^[77]

Parameter	Symbol	100 MHz		Unit
		Min	Max	
HyperRAM PSC transition to RWDS transition	$t_{PSCRWDS}$	1	7	ns
Time delta between CK to DQ valid and PSC to RWDS	$t_{PSCRWDS} - t_{CKD}$	-1.0	+0.5	ns

Note

77. Sampled, not 100% tested.

Table 28. DCARS Read Timings (1.8 V)^[78]

Parameter	Symbol	133 MHz		100 MHz		Unit
		Min	Max	Min	Max	
HyperRAM PSC transition to RWDS transition	$t_{PSCRWDS}$	1	5.5	1	5.5	ns
Time delta between CK to DQ valid and PSC to RWDS	$t_{PSCRWDS} - t_{CKD}$	-1.0	+0.5	-1.0	+0.5	ns

Note

78. Sampled, not 100% tested.

Notes

 73. This figure shows a closer view of the data transfer portion of [Figure 27 on page 41](#) in order to more clearly show the Data Valid period as affected by clock jitter and clock to output delay uncertainty.

74. CK# and PSC# are only used on the 1.8 V device. The 3 V device uses a single ended CK and PSC input.

75. The delay (phase shift) from CK to PSC is controlled by the HyperBus master interface (Host) and is generally between 40 and 140 degrees in order to place the RWDS edge within the data valid window with sufficient set-up and hold time of data to RWDS. The requirements for data set-up and hold time to RWDS are determined by the HyperBus master interface design and are not addressed by the HyperBus slave timing parameters.

 76. The HyperBus timing parameters of t_{CKD} and t_{CKDl} define the beginning and end position of the data valid period. The t_{CKD} and t_{CKDl} values track together (vary by the same ratio) because RWDS and Data are outputs from the same device under the same voltage and temperature conditions.

11. Ordering Information

11.1 Ordering Part Number

The ordering part number is formed by a valid combination of the following:



11.2 Valid Combinations

The Recommended Combinations table lists configurations planned to be available in volume. The table below will be updated as new combinations are released. Consult your local sales representative to confirm availability of specific combinations and to check on newly released combinations.

Table 29. Valid Combinations — Standard

Device Family	Density	Technology	Speed	Package, Material and Temperature	Model Number	Packing Type	Ordering Part Number	Package Marking
S27KL	064	1	DA	BHI	02	0	S27KL0641DABHI020	7KL0641DAHI02
S27KL	064	1	DA	BHI	02	3	S27KL0641DABHI023	7KL0641DAHI02
S27KL	064	1	DA	BHV	02	0	S27KL0641DABHV020	7KL0641DAHV02
S27KL	064	1	DA	BHV	02	3	S27KL0641DABHV023	7KL0641DAHV02
S70KL	128	1	DA	BHI	02	0	S70KL1281DABHI020	7KL1281DAHI02
S70KL	128	1	DA	BHI	02	3	S70KL1281DABHI023	7KL1281DAHI02
S70KL	128	1	DA	BHV	02	0	S70KL1281DABHV020	7KL1281DAHV02
S70KL	128	1	DA	BHV	02	3	S70KL1281DABHV023	7KL1281DAHV02
S27KS	064	1	DP	BHI	02	0	S27KS0641DPBHI020	7KS0641DPHI02
S27KS	064	1	DP	BHI	02	3	S27KS0641DPBHI023	7KS0641DPHI02
S27KS	064	1	DP	BHV	02	0	S27KS0641DPBHV020	7KS0641DPHV02
S27KS	064	1	DP	BHV	02	3	S27KS0641DPBHV023	7KS0641DPHV02
S70KS	128	1	DP	BHI	02	0	S70KS1281DPBHI020	7KS1281DPHI02
S70KS	128	1	DP	BHI	02	3	S70KS1281DPBHI023	7KS1281DPHI02
S70KS	128	1	DP	BHV	02	0	S70KS1281DPBHV020	7KS1281DPHV02
S70KS	128	1	DP	BHV	02	3	S70KS1281DPBHV023	7KS1281DPHV02

Table 30. Valid Combinations — DCARS

Device Family	Density	Technology	Speed	Package, Material and Temperature	Model Number	Packing Type	Ordering Part Number	Package Marking
S27KL	064	1	DA	BHI	03	0	S27KL0641DABHI030	7KL0641DAHI03
S27KL	064	1	DA	BHI	03	3	S27KL0641DABHI033	7KL0641DAHI03
S27KL	064	1	DA	BHV	03	0	S27KL0641DABHV030	7KL0641DAHV03
S27KL	064	1	DA	BHV	03	3	S27KL0641DABHV033	7KL0641DAHV03
S70KL	128	1	DA	BHI	03	0	S70KL1281DABHI030	7KL1281DAHI03
S70KL	128	1	DA	BHI	03	3	S70KL1281DABHI033	7KL1281DAHI03
S70KL	128	1	DA	BHV	03	0	S70KL1281DABHV030	7KL1281DAHV03
S70KL	128	1	DA	BHV	03	3	S70KL1281DABHV033	7KL1281DAHV03
S27KS	064	1	DA	BHI	03	0	S27KS0641DABHI030	7KS0641DAHI03
S27KS	064	1	DA	BHI	03	3	S27KS0641DABHI033	7KS0641DAHI03
S27KS	064	1	DA	BHV	03	0	S27KS0641DABHV030	7KS0641DAHV03
S27KS	064	1	DA	BHV	03	3	S27KS0641DABHV033	7KS0641DAHV03
S70KS	128	1	DA	BHI	03	0	S70KS1281DABHI030	7KS1281DAHI03
S70KS	128	1	DA	BHI	03	3	S70KS1281DABHI033	7KS1281DAHI03
S70KS	128	1	DA	BHV	03	0	S70KS1281DABHV030	7KS1281DAHV03
S70KS	128	1	DA	BHV	03	3	S70KS1281DABHV033	7KS1281DAHV03
S27KS	064	1	DG	BHI	03	0	S27KS0641DGBHI030	7KS0641DGH03
S27KS	064	1	DG	BHI	03	3	S27KS0641DGBHI033	7KS0641DGH03
S27KS	064	1	DG	BHV	03	0	S27KS0641DGBHV030	7KS0641DGHV03
S27KS	064	1	DG	BHV	03	3	S27KS0641DGBHV033	7KS0641DGHV03
S70KS	128	1	DG	BHI	03	0	S70KS1281DGBHI030	7KS1281DGH03
S70KS	128	1	DG	BHI	03	3	S70KS1281DGBHI033	7KS1281DGH03
S70KS	128	1	DG	BHV	03	0	S70KS1281DGBHV030	7KS1281DGHV03
S70KS	128	1	DG	BHV	03	3	S70KS1281DGBHV033	7KS1281DGHV03

11.3 Valid Combinations — Automotive Grade / AEC-Q100

The table below lists configurations that are Automotive Grade / AEC-Q100 qualified and are planned to be available in volume. The table will be updated as new combinations are released. Consult your local sales representative to confirm availability of specific combinations and to check on newly released combinations.

Production Part Approval Process (PPAP) support is only provided for AEC-Q100 grade products.

Products to be used in end-use applications that require ISO/TS-16949 compliance must be AEC-Q100 grade products in combination with PPAP. Non-AEC-Q100 grade products are not manufactured or documented in full compliance with ISO/TS-16949 requirements.

AEC-Q100 grade products are also offered without PPAP support for end-use applications that do not require ISO/TS-16949 compliance.

Table 31. Valid Combinations — Automotive Grade / AEC-Q100

Device Family	Density	Technology	Speed	Package, Material and Temperature	Model Number	Packing Type	Ordering Part Number	Package Marking
S27KL	064	1	DA	BHA	02	0	S27KL0641DABHA020	7KL0641DAHA02
S27KL	064	1	DA	BHA	02	3	S27KL0641DABHA023	7KL0641DAHA02
S27KL	064	1	DA	BHB	02	0	S27KL0641DABHB020	7KL0641DAHB02
S27KL	064	1	DA	BHB	02	3	S27KL0641DABHB023	7KL0641DAHB02
S70KL	128	1	DA	BHA	02	0	S70KL1281DABHA020	7KL1281DAHA02
S70KL	128	1	DA	BHA	02	3	S70KL1281DABHA023	7KL1281DAHA02
S70KL	128	1	DA	BHB	02	0	S70KL1281DABHB020	7KL1281DAHB02
S70KL	128	1	DA	BHB	02	3	S70KL1281DABHB023	7KL1281DAHB02
S27KS	064	1	DP	BHA	02	0	S27KS0641DPBHA020	7KS0641DPHA02
S27KS	064	1	DP	BHA	02	3	S27KS0641DPBHA023	7KS0641DPHA02
S27KS	064	1	DP	BHB	02	0	S27KS0641DPBHB020	7KS0641DPHB02
S27KS	064	1	DP	BHB	02	3	S27KS0641DPBHB023	7KS0641DPHB02
S70KS	128	1	DP	BHA	02	0	S70KS1281DPBHA020	7KS1281DPHA02
S70KS	128	1	DP	BHA	02	3	S70KS1281DPBHA023	7KS1281DPHA02
S70KS	128	1	DP	BHB	02	0	S70KS1281DPBHB020	7KS1281DPHB02
S70KS	128	1	DP	BHB	02	3	S70KS1281DPBHB023	7KS1281DPHB02

Table 32. Valid Combinations — DCARS Automotive Grade / AEC-Q100

Device Family	Density	Technology	Speed	Package, Material and Temperature	Model Number	Packing Type	Ordering Part Number	Package Marking
S27KL	064	1	DA	BHA	03	0	S27KL0641DABHA030	7KL0641DAHA03
S27KL	064	1	DA	BHA	03	3	S27KL0641DABHA033	7KL0641DAHA03
S27KL	064	1	DA	BHB	03	0	S27KL0641DABHB030	7KL0641DAHB03
S27KL	064	1	DA	BHB	03	3	S27KL0641DABHB033	7KL0641DAHB03
S70KL	128	1	DA	BHA	03	0	S70KL1281DABHA030	7KL1281DAHA03
S70KL	128	1	DA	BHA	03	3	S70KL1281DABHA033	7KL1281DAHA03
S70KL	128	1	DA	BHB	03	0	S70KL1281DABHB030	7KL1281DAHB03
S70KL	128	1	DA	BHB	03	3	S70KL1281DABHB033	7KL1281DAHB03
S27KS	064	1	DA	BHA	03	0	S27KS0641DABHA030	7KS0641DAHA03
S27KS	064	1	DA	BHA	03	3	S27KS0641DABHA033	7KS0641DAHA03
S27KS	064	1	DA	BHB	03	0	S27KS0641DABHB030	7KS0641DAHB03
S27KS	064	1	DA	BHB	03	3	S27KS0641DABHB033	7KS0641DAHB03
S70KS	128	1	DA	BHA	03	0	S70KS1281DABHA030	7KS1281DAHA03
S70KS	128	1	DA	BHA	03	3	S70KS1281DABHA033	7KS1281DAHA03
S70KS	128	1	DA	BHB	03	0	S70KS1281DABHB030	7KS1281DAHB03
S70KS	128	1	DA	BHB	03	3	S70KS1281DABHB033	7KS1281DAHB03
S27KS	064	1	DG	BHA	03	0	S27KS0641DGBHA030	7KS0641DGHA03
S27KS	064	1	DG	BHA	03	3	S27KS0641DGBHA033	7KS0641DGHA03
S27KS	064	1	DG	BHB	03	0	S27KS0641DGBHB030	7KS0641DGHB03
S27KS	064	1	DG	BHB	03	3	S27KS0641DGBHB033	7KS0641DGHB03
S70KS	128	1	DG	BHA	03	0	S70KS1281DGBHA030	7KS1281DGHA03
S70KS	128	1	DG	BHA	03	3	S70KS1281DGBHA033	7KS1281DGHA03
S70KS	128	1	DG	BHB	03	0	S70KS1281DGBHB030	7KS1281DGHB03
S70KS	128	1	DG	BHB	03	3	S70KS1281DGBHB033	7KS1281DGHB03

12. Revision History

Document Title: S27KL0641/S27KS0641/S70KL1281/S70KS1281, 3.0 V/1.8 V, 64 Mb (8 MB)/128 Mb (16 MB), HyperRAM™ Self-Refresh DRAM Document Number: 001-97964				
Rev.	ECN No.	Orig. of Change	Submission Date	Description of Change
**	-	MAMC	05/01/2015	Initial release.
*A	-	MAMC	06/05/2015	Read Transactions: Maximum Operating Frequency For Latency Code Options table: updated 'Latency Code' 0010 values Device Identification Registers: Updated 'ID Register 1 Bit Assignments' table Electrical Specifications: Updated Ambient Temperature with Power Applied HyperRAM Hardware Interface: Updated the following: Power-On Reset: removed section Power Down: removed section DC Characteristics (CMOS Compatible) table: updated I _{CC5} , I _{CC6I} , and I _{CC6IP} Test Conditions Electrical Specifications/Power Down: 1.8V Power-Down Voltage and Timing table: changed V _{RST} and T _{PD} Min 3.0V Power-Down Voltage and Timing table: changed V _{RST} and T _{PD} Min Key to Switching Waveforms: removed section AC Test Conditions: removed section AC Characteristics: updated section HyperBus Specification: Removed section. Refer to the HyperBus specification for all non-device specific information on the HyperBus interface.
*B	-	MAMC	07/10/2015	Physical Interface: Updated section. Ordering Information: Updated Valid Combinations table.
*C	4854266	MAMC	07/29/2015	Updated to Cypress template.
*D	5041839	MAMC	12/08/2015	Updated Electrical Specifications : Updated DC Characteristics : Updated details of I _{L1} parameter. Added values of I _{DPD} parameter corresponding to "Test Condition" T _A = 105°C.
*E	5155616	RYSU	03/01/2016	Added Errata.
*F	5327405	SZZX	06/28/2016	Complete update. Removed Errata.
*G	5430299	RYSU	09/08/2016	Changed status from "Advance" to "Final". Updated Electrical Specifications : Updated Operating Ranges : Updated Temperature Ranges : Added Automotive Grade. Updated Ordering Information : Added Valid Combinations — Automotive Grade / AEC-Q100 . Updated to new template.
*H	5500343	SZZX	11/03/2016	Updated Electrical Specifications : Updated DC Characteristics : Updated Table 16 . Updated Physical Interface : Updated Physical Diagrams : Updated Fortified Ball Grid Array 24-ball 6 x 8 x 1.0 mm (VAA024) .

Document Title: S27KL0641/S27KS0641/S70KL1281/S70KS1281, 3.0 V/1.8 V, 64 Mb (8 MB)/128 Mb (16 MB), HyperRAM™ Self-Refresh DRAM
 Document Number: 001-97964

Rev.	ECN No.	Orig. of Change	Submission Date	Description of Change
*I	5560735	SZZX	12/20/2016	<p>Updated Document Title to read as "S27KL0641/S27KS0641/S70KL1281/S70KS1281, 3.0 V/1.8 V, 64 Mb (8 MB)/128 Mb (16 MB), HyperRAM™ Self-Refresh DRAM".</p> <p>Added S70KL1281 and S70KS1281 part numbers related information in all instances across the document.</p> <p>Updated Performance Summary: Updated Maximum Current Consumption table.</p> <p>Added Block Diagram — 128 Mb.</p> <p>Updated General Description: Updated description.</p> <p>Updated Product Overview: Updated description.</p> <p>Updated Memory Space: Updated Table 5.</p> <p>Updated Register Space: Updated Table 6.</p> <p>Updated Register Space Access: Updated Configuration Register 0: Updated Table 9.</p> <p>Updated Hybrid Burst: Added Note below Table 11.</p> <p>Updated Fixed Latency: Updated description.</p> <p>Updated Deep Power Down: Updated description.</p> <p>Updated Interface States: Updated description.</p> <p>Updated Electrical Specifications: Updated DC Characteristics: Updated Table 16.</p> <p>Updated HIGHCapacitance Characteristics: Updated Table 7.2. Updated Table 7.3.</p> <p>Updated Timing Specifications: Updated AC Characteristics: Updated Read Transactions: Updated Table 22. Updated Table 23. Added Figure 24.</p> <p>Updated Write Transactions: Added Figure 25.</p> <p>Updated Ordering Information: Updated Ordering Part Number: Added 128 Mb details.</p> <p>Updated Valid Combinations on page 45: Updated Table 29. Updated Table 30. Updated Valid Combinations — Automotive Grade / AEC-Q100: Updated Table 31. Updated Table 32.</p>
*J	5688128	RUPA	04/10/2017	<p>Updated Cypress logo. Updated Copyright.</p>
*K	5844216	SZZX	08/04/2017	Updated KL/KS1281 DC parameters
*L	6267725	MNAD	07/31/2018	<p>Updated template. Added a note in Table 25.</p>

Sales, Solutions, and Legal Information

Worldwide Sales and Design Support

Cypress maintains a worldwide network of offices, solution centers, manufacturer's representatives, and distributors. To find the office closest to you, visit us at [Cypress Locations](#).

Products

Arm® Cortex® Microcontrollers	cypress.com/arm
Automotive	cypress.com/automotive
Clocks & Buffers	cypress.com/clocks
Interface	cypress.com/interface
Internet of Things	cypress.com/iot
Memory	cypress.com/memory
Microcontrollers	cypress.com/mcu
PSoC	cypress.com/psoc
Power Management ICs	cypress.com/pmic
Touch Sensing	cypress.com/touch
USB Controllers	cypress.com/usb
Wireless Connectivity	cypress.com/wireless

PSoC® Solutions

[PSoC 1](#) | [PSoC 3](#) | [PSoC 4](#) | [PSoC 5LP](#) | [PSoC 6 MCU](#)

Cypress Developer Community

[Community](#) | [Projects](#) | [Video](#) | [Blogs](#) | [Training](#) | [Components](#)

Technical Support

cypress.com/support

© Cypress Semiconductor Corporation, 2015-2018. This document is the property of Cypress Semiconductor Corporation and its subsidiaries, including Spansion LLC ("Cypress"). This document, including any software or firmware included or referenced in this document ("Software"), is owned by Cypress under the intellectual property laws and treaties of the United States and other countries worldwide. Cypress reserves all rights under such laws and treaties and does not, except as specifically stated in this paragraph, grant any license under its patents, copyrights, trademarks, or other intellectual property rights. If the Software is not accompanied by a license agreement and you do not otherwise have a written agreement with Cypress governing the use of the Software, then Cypress hereby grants you a personal, non-exclusive, nontransferable license (without the right to sublicense) (1) under its copyright rights in the Software (a) for Software provided in source code form, to modify and reproduce the Software solely for use with Cypress hardware products, only internally within your organization, and (b) to distribute the Software in binary code form externally to end users (either directly or indirectly through resellers and distributors), solely for use on Cypress hardware product units, and (2) under those claims of Cypress's patents that are infringed by the Software (as provided by Cypress, unmodified) to make, use, distribute, and import the Software solely for use with Cypress hardware products. Any other use, reproduction, modification, translation, or compilation of the Software is prohibited.

TO THE EXTENT PERMITTED BY APPLICABLE LAW, CYPRESS MAKES NO WARRANTY OF ANY KIND, EXPRESS OR IMPLIED, WITH REGARD TO THIS DOCUMENT OR ANY SOFTWARE OR ACCOMPANYING HARDWARE, INCLUDING, BUT NOT LIMITED TO, THE IMPLIED WARRANTIES OF MERCHANTABILITY AND FITNESS FOR A PARTICULAR PURPOSE. No computing device can be absolutely secure. Therefore, despite security measures implemented in Cypress hardware or software products, Cypress does not assume any liability arising out of any security breach, such as unauthorized access to or use of a Cypress product. In addition, the products described in these materials may contain design defects or errors known as errata which may cause the product to deviate from published specifications. To the extent permitted by applicable law, Cypress reserves the right to make changes to this document without further notice. Cypress does not assume any liability arising out of the application or use of any product or circuit described in this document. Any information provided in this document, including any sample design information or programming code, is provided only for reference purposes. It is the responsibility of the user of this document to properly design, program, and test the functionality and safety of any application made of this information and any resulting product. Cypress products are not designed, intended, or authorized for use as critical components in systems designed or intended for the operation of weapons, weapons systems, nuclear installations, life-support devices or systems, other medical devices or systems (including resuscitation equipment and surgical implants), pollution control or hazardous substances management, or other uses where the failure of the device or system could cause personal injury, death, or property damage ("Unintended Uses"). A critical component is any component of a device or system whose failure to perform can be reasonably expected to cause the failure of the device or system, or to affect its safety or effectiveness. Cypress is not liable, in whole or in part, and you shall and hereby do release Cypress from any claim, damage, or other liability arising from or related to all Unintended Uses of Cypress products. You shall indemnify and hold Cypress harmless from and against all claims, costs, damages, and other liabilities, including claims for personal injury or death, arising from or related to any Unintended Uses of Cypress products.

Cypress, the Cypress logo, Spansion, the Spansion logo, and combinations thereof, WICED, PSoC, CapSense, EZ-USB, F-RAM, and Traveo are trademarks or registered trademarks of Cypress in the United States and other countries. For a more complete list of Cypress trademarks, visit cypress.com. Other names and brands may be claimed as property of their respective owners.

Компания «Life Electronics» занимается поставками электронных компонентов импортного и отечественного производства от производителей и со складов крупных дистрибьюторов Европы, Америки и Азии.

С конца 2013 года компания активно расширяет линейку поставок компонентов по направлению коаксиальный кабель, кварцевые генераторы и конденсаторы (керамические, пленочные, электролитические), за счёт заключения дистрибьюторских договоров

Мы предлагаем:

- Конкуренспособные цены и скидки постоянным клиентам.
- Специальные условия для постоянных клиентов.
- Подбор аналогов.
- Поставку компонентов в любых объемах, удовлетворяющих вашим потребностям.
- Приемлемые сроки поставки, возможна ускоренная поставка.
- Доставку товара в любую точку России и стран СНГ.
- Комплексную поставку.
- Работу по проектам и поставку образцов.
- Формирование склада под заказчика.
- Сертификаты соответствия на поставляемую продукцию (по желанию клиента).
- Тестирование поставляемой продукции.
- Поставку компонентов, требующих военную и космическую приемку.
- Входной контроль качества.
- Наличие сертификата ISO.

В составе нашей компании организован Конструкторский отдел, призванный помогать разработчикам, и инженерам.

Конструкторский отдел помогает осуществить:

- Регистрацию проекта у производителя компонентов.
- Техническую поддержку проекта.
- Защиту от снятия компонента с производства.
- Оценку стоимости проекта по компонентам.
- Изготовление тестовой платы монтаж и пусконаладочные работы.



Тел: +7 (812) 336 43 04 (многоканальный)

Email: org@lifeelectronics.ru