

Parameter	Ratings	Units
Blocking Voltage	300	$V_P$
Load Current	170	$mA_{rms} / mA_{DC}$
On-Resistance (max)	16	$\Omega$

### Features

- 3750V<sub>rms</sub> Input/Output Isolation
- Low Drive Power Requirements (TTL/CMOS Compatible)
- High Reliability
- Arc-Free With No Snubbing Circuits
- FCC Compatible
- VDE Compatible
- No EMI/RFI Generation
- Small 6-Pin Package
- Machine Insertable, Wave Solderable
- Surface Mount Tape & Reel Version Available

### Applications

- Telecommunications
  - Telecom Switching
  - Tip/Ring Circuits
  - Modem Switching (Laptop, Notebook, Pocket Size)
  - Hook Switch
  - Dial Pulsing
  - Ground Start
  - Ringing Injection
- Instrumentation
  - Multiplexers
  - Data Acquisition
  - Electronic Switching
  - I/O Subsystems
- Meters (Watt-Hour, Water, Gas)
- Medical Equipment—Patient/Equipment Isolation
- Security
- Aerospace
- Industrial Controls

### Description

LCA125 is a 300V, 170mA, 16 $\Omega$ , normally open (1-Form-A) solid state relay that uses optically coupled MOSFET technology to provide 3750V<sub>rms</sub> of input to output isolation.

Its optically coupled outputs, which use the patented OptoMOS architecture, are controlled by a highly efficient GaAIAs infrared LED.

Use the LCA125 to replace mechanical relays, and gain the superior reliability associated with semiconductor devices. Because they have no moving parts, they offer faster, bounce-free switching in a more compact surface mount or through hole package.

### Approvals

- UL Recognized Component: File # E76270
- CSA Certified Component: Certificate 1172007
- Certified to:
  - EN60950-1: 2006
  - EN60950-1: 2005
  - TUV Certificate: B 09 07 49410 004

### Ordering Information

Part #	Description
LCA125	6-Pin DIP (50/Tube)
LCA125S	6-Pin Surface Mount (50/Tube)
LCA125STR	6-Pin Surface Mount (1,000/Reel)

### Pin Configuration

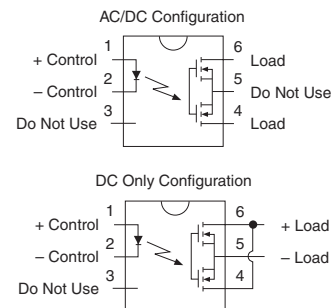

### Switching Characteristics of Normally Open (Form A) Devices

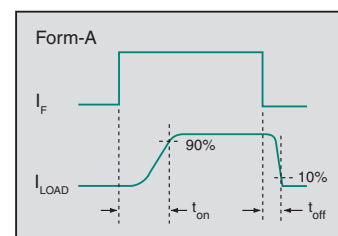

### Absolute Maximum Ratings @25°C

Parameter	Ratings	Units
Blocking Voltage	300	V <sub>P</sub>
Reverse Input Voltage	5	V
Input Control Current Peak (10ms)	50	mA
	1	A
Input Power Dissipation <sup>1</sup>	150	mW
Total Power Dissipation <sup>2</sup>	800	mW
Isolation Voltage, Input to Output	3750	V <sub>rms</sub>
Operational Temperature	-40 to +85	°C
Storage Temperature	-40 to +125	°C

Absolute Maximum Ratings are stress ratings. Stresses in excess of these ratings can cause permanent damage to the device. Functional operation of the device at conditions beyond those indicated in the operational sections of this data sheet is not implied.

<sup>1</sup> Derate linearly 1.33 mW / °C

<sup>2</sup> Derate linearly 6.67 mW / °C

### Electrical Characteristics @25°C (Unless Otherwise Noted)

Parameter	Conditions	Symbol	Min	Typ	Max	Units
<b>Output Characteristics</b>						
Load Current AC/DC Configuration, Continuous <sup>1</sup> DC Configuration, Continuous <sup>1</sup> Peak	-	I <sub>L</sub>	-	-	170	mA <sub>rms</sub> / mA <sub>DC</sub>
	-		-	-	300	mA <sub>DC</sub>
	t=10ms	I <sub>LPK</sub>	-	-	400	mA <sub>P</sub>
On-Resistance <sup>2</sup> AC/DC Configuration DC Configuration	I <sub>L</sub> =170mA	R <sub>ON</sub>	-	10	16	Ω
	I <sub>L</sub> =300mA		-	4	5	
Off-State Leakage Current	V <sub>L</sub> =300V	I <sub>LEAK</sub>	-	-	1	μA
<b>Switching Speeds</b>						
Turn-On	I <sub>F</sub> = 5mA, V <sub>L</sub> = 10V	t <sub>on</sub>	-	-	5	ms
Turn-Off		t <sub>off</sub>	-	-	5	ms
Output Capacitance	50V, f=1MHz	C <sub>OUT</sub>	-	50	-	pF
<b>Input Characteristics</b>						
Input Control Current to Activate	I <sub>L</sub> = 170mA	I <sub>F</sub>	-	-	5	mA
Input Control Current to Deactivate	-	I <sub>F</sub>	0.4	0.7	-	mA
Input Voltage Drop	I <sub>F</sub> = 5mA	V <sub>F</sub>	0.9	1.2	1.4	V
Reverse Input Current	V <sub>R</sub> = 5V	I <sub>R</sub>	-	-	10	μA
<b>Common Characteristics</b>						
Capacitance, Input to Output	-	C <sub>I/O</sub>	-	3	-	pF

<sup>1</sup> If both poles operate, then the load current must be derated so that the package power dissipation value is not exceeded.

<sup>2</sup> Measurement taken within 1 second of on-time.

**PERFORMANCE DATA @25°C (Unless Otherwise Noted)\***

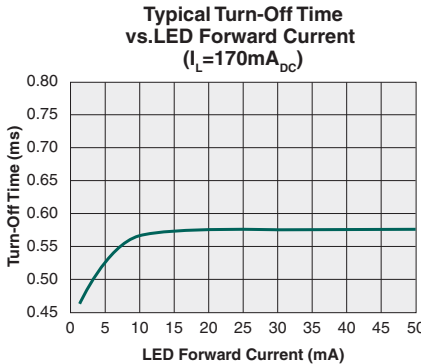
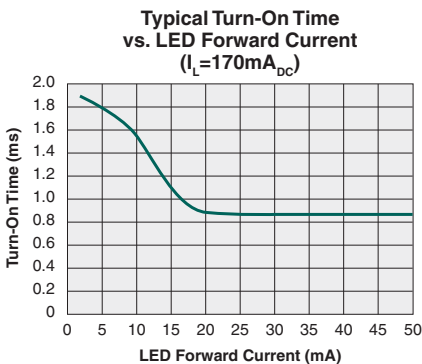
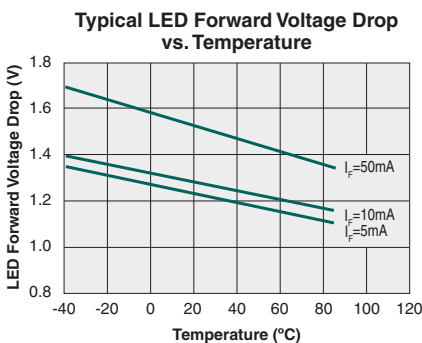
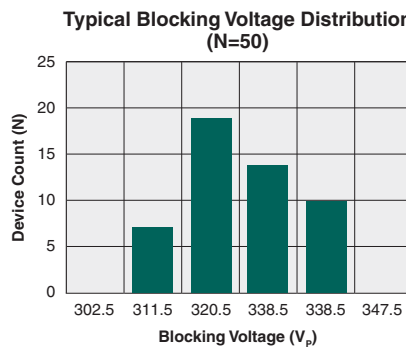
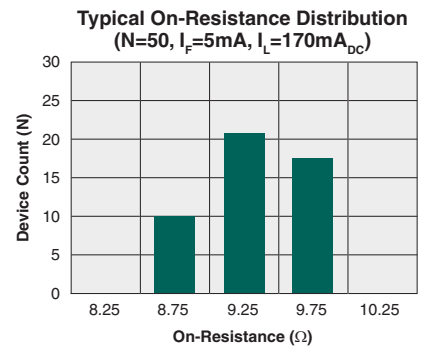
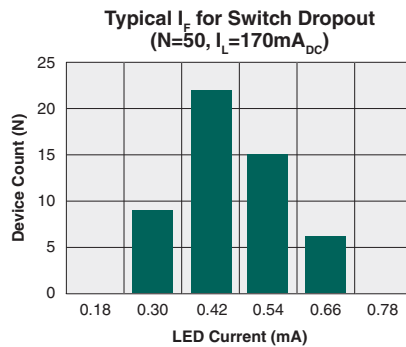
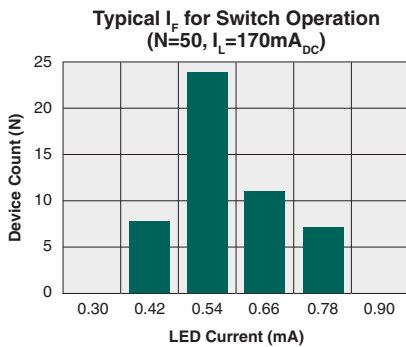
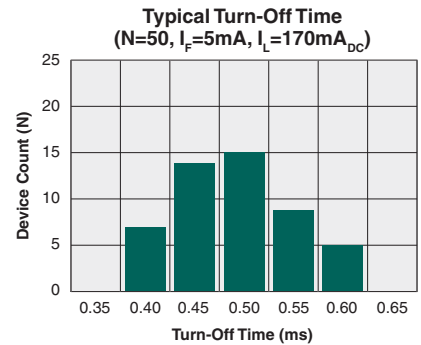
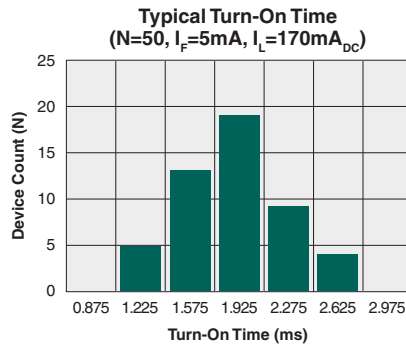
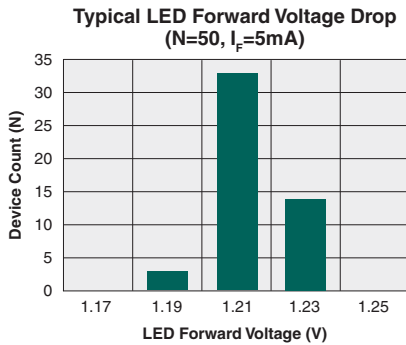

\*The Performance data shown in the graphs above is typical of device performance. For guaranteed parameters not indicated in the written specifications, please contact our application department.

**PERFORMANCE DATA @25°C (Unless Otherwise Noted)\***

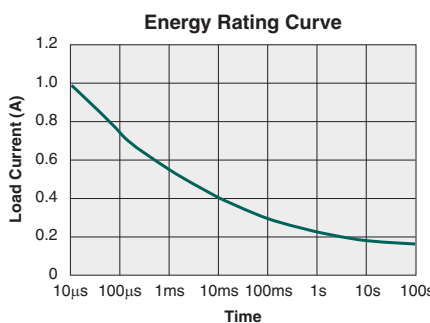
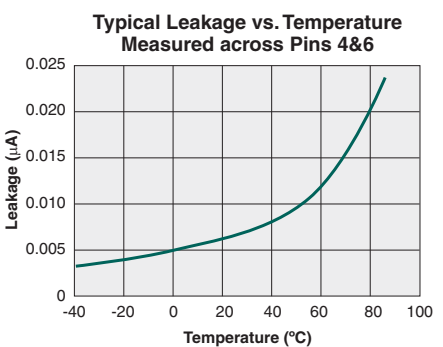
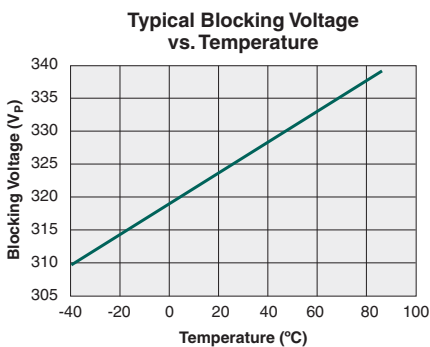
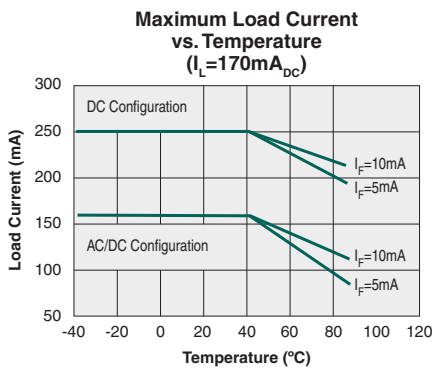
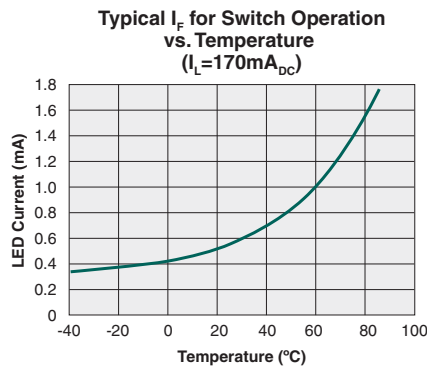
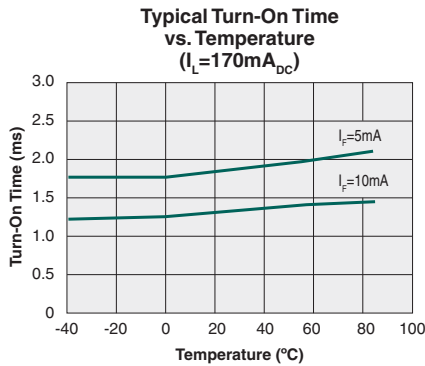

\*The Performance data shown in the graphs above is typical of device performance. For guaranteed parameters not indicated in the written specifications, please contact our application department.

## Manufacturing Information

### Moisture Sensitivity



All plastic encapsulated semiconductor packages are susceptible to moisture ingress. IXYS Integrated Circuits Division classified all of its plastic encapsulated devices for moisture sensitivity according to the latest version of the joint industry standard, **IPC/JEDEC J-STD-020**, in force at the time of product evaluation. We test all of our products to the maximum conditions set forth in the standard, and guarantee proper operation of our devices when handled according to the limitations and information in that standard as well as to any limitations set forth in the information or standards referenced below.

Failure to adhere to the warnings or limitations as established by the listed specifications could result in reduced product performance, reduction of operable life, and/or reduction of overall reliability.

This product carries a **Moisture Sensitivity Level (MSL) rating** as shown below, and should be handled according to the requirements of the latest version of the joint industry standard **IPC/JEDEC J-STD-033**.

Device	Moisture Sensitivity Level (MSL) Rating
LCA125 / LCA125S	MSL 1

### ESD Sensitivity



This product is **ESD Sensitive**, and should be handled according to the industry standard **JESD-625**.

### Reflow Profile

This product has a maximum body temperature and time rating as shown below. All other guidelines of **J-STD-020** must be observed.

Device	Maximum Temperature x Time
LCA125 / LCA125S	250°C for 30 seconds

### Board Wash

IXYS Integrated Circuits Division recommends the use of no-clean flux formulations. However, board washing to remove flux residue is acceptable. Since IXYS Integrated Circuits Division employs the use of silicone coating as an optical waveguide in many of its optically isolated products, the use of a short drying bake could be necessary if a wash is used after solder reflow processes. Chlorine- or Fluorine-based solvents or fluxes should not be used. Cleaning methods that employ ultrasonic energy should not be used.



**MECHANICAL DIMENSIONS**

**LCA125**

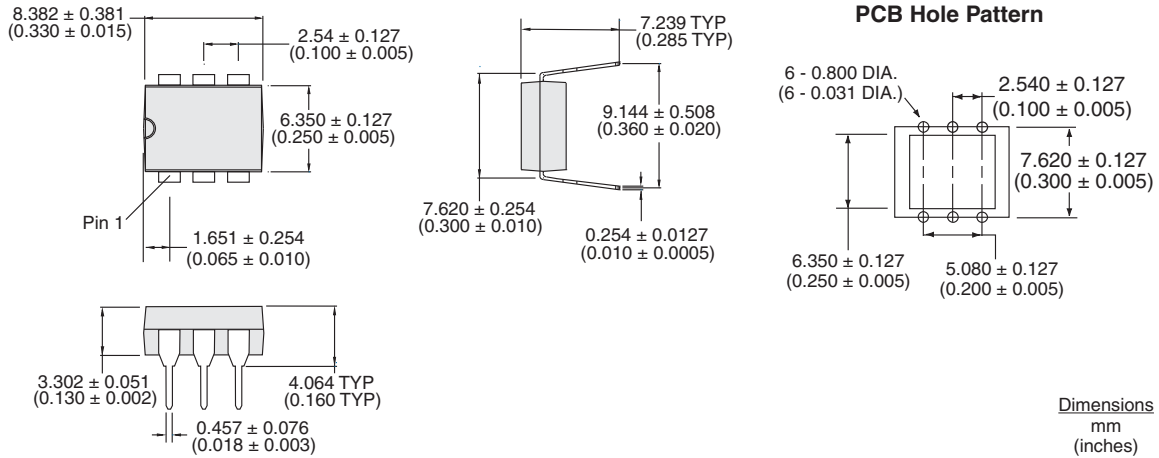

**LCA125S**

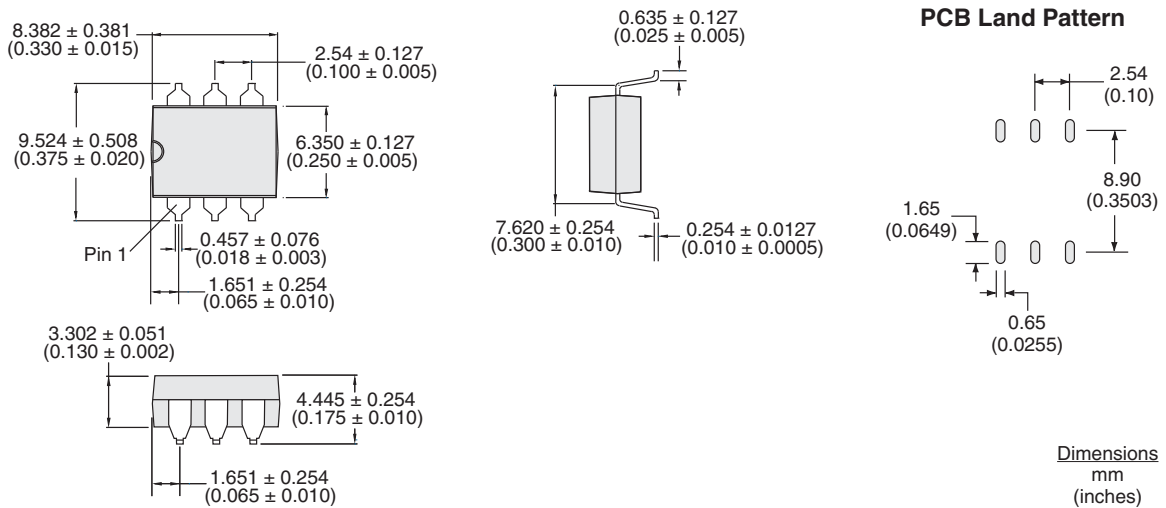

**LCA125STR Tape & Reel**

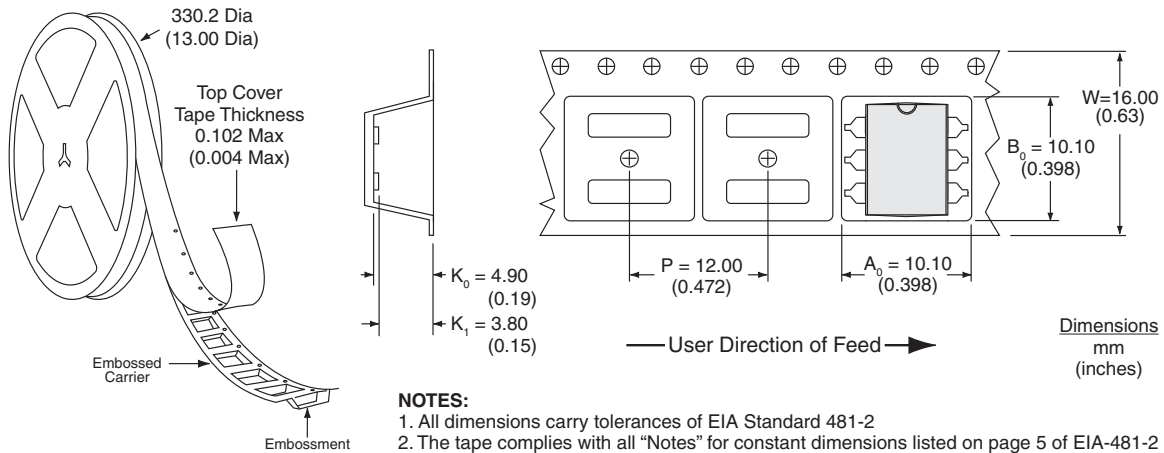

**For additional information please visit our website at: [www.ixysic.com](http://www.ixysic.com)**

IXYS Integrated Circuits Division makes no representations or warranties with respect to the accuracy or completeness of the contents of this publication and reserves the right to make changes to specifications and product descriptions at any time without notice. Neither circuit patent licenses nor indemnity are expressed or implied. Except as set forth in IXYS Integrated Circuits Division's Standard Terms and Conditions of Sale, IXYS Integrated Circuits Division assumes no liability whatsoever, and disclaims any express or implied warranty, relating to its products including, but not limited to, the implied warranty of merchantability, fitness for a particular purpose, or infringement of any intellectual property right.

The products described in this document are not designed, intended, authorized or warranted for use as components in systems intended for surgical implant into the body, or in other applications intended to support or sustain life, or where malfunction of IXYS Integrated Circuits Division's product may result in direct physical harm, injury, or death to a person or severe property or environmental damage. IXYS Integrated Circuits Division reserves the right to discontinue or make changes to its products at any time without notice.

Specification: DS-LCA125-R09  
©Copyright 2012, IXYS Integrated Circuits Division  
OptoMOS® is a registered trademark of IXYS Integrated Circuits Division  
All rights reserved. Printed in USA.  
12/22/2012

Компания «Life Electronics» занимается поставками электронных компонентов импортного и отечественного производства от производителей и со складов крупных дистрибьюторов Европы, Америки и Азии.

С конца 2013 года компания активно расширяет линейку поставок компонентов по направлению коаксиальный кабель, кварцевые генераторы и конденсаторы (керамические, пленочные, электролитические), за счёт заключения дистрибьюторских договоров

Мы предлагаем:

- Конкурентоспособные цены и скидки постоянным клиентам.
- Специальные условия для постоянных клиентов.
- Подбор аналогов.
- Поставку компонентов в любых объемах, удовлетворяющих вашим потребностям.
- Приемлемые сроки поставки, возможна ускоренная поставка.
- Доставку товара в любую точку России и стран СНГ.
- Комплексную поставку.
- Работу по проектам и поставку образцов.
- Формирование склада под заказчика.
- Сертификаты соответствия на поставляемую продукцию (по желанию клиента).
- Тестирование поставляемой продукции.
- Поставку компонентов, требующих военную и космическую приемку.
- Входной контроль качества.
- Наличие сертификата ISO.

В составе нашей компании организован Конструкторский отдел, призванный помогать разработчикам, и инженерам.

Конструкторский отдел помогает осуществить:

- Регистрацию проекта у производителя компонентов.
- Техническую поддержку проекта.
- Защиту от снятия компонента с производства.
- Оценку стоимости проекта по компонентам.
- Изготовление тестовой платы монтаж и пусконаладочные работы.



Тел: +7 (812) 336 43 04 (многоканальный)

Email: [org@lifeelectronics.ru](mailto:org@lifeelectronics.ru)