

GaAs pHEMT MMIC 1 WATT POWER AMPLIFIER With Power Detector, 37 - 40 GHz

Typical Applications

The HMC7229LS6 is ideal for:

- Point-to-Point Radios
- Point-to-Multi-Point Radios
- VSAT & SATCOM
- Military & Space

Features

- P1dB Output Power: 31.5 dBm
- Saturated Output Power: +32 dBm
- High Output IP3: 40 dBm
- High Gain: 24 dB
- DC Power Supply: 6V @ 1200 mA
- 50 Ohm Matched Input/Output
- 16 Lead 6x6 mm SMT Package: 36 mm²

Functional Diagram

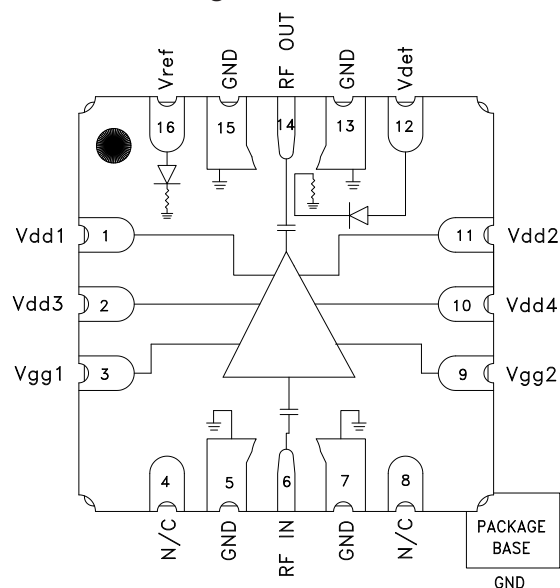

General Description

The HMC7229LS6 is a four-stage GaAs pHEMT MMIC 1 Watt Power Amplifier which operates between 37 and 40 GHz. The HMC7229LS6 provides 24 dB of gain, +32 dBm of saturated output power, and 18% PAE from a +6V supply. With an excellent OIP3 of +40 dBm, the HMC7229LS6 is ideal for high linearity applications in military and space as well as point-to-point and point-to-multi-point radios. The RF I/Os are internally matched and DC blocked for ease of integration into higher level assemblies. The HMC7229LS6 is housed in a ceramic air cavity package which exhibits low thermal resistance and is compatible with surface mount manufacturing techniques.

Electrical Specifications

$T_A = +25^\circ \text{C}$, $V_{dd} = V_{dd1} = V_{dd2} = V_{dd3} = V_{dd4} = +6\text{V}$, $I_{dd} = 1200 \text{ mA}$ [1]

Parameter	Min.	Typ.	Max.	Units
Frequency Range	37 - 40			GHz
Gain	21	24		dB
Gain Variation over Temperature		0.058		dB/°C
Input Return Loss		16		dB
Output Return Loss		14		dB
Output Power for P1dB Compression	28.5	31.5		dBm
Saturated Output Power (Psat)		32		dBm
Output Third Order Intercept (IP3) [2]		40		dBm
Total Supply Current (Idd)		1200		mA

[1] Adjust Vgg between -2 to 0V to achieve Idd = 1200mA typical

[2] Measurement taken at Pout / tone = +20dBm.



GaAs pHEMT MMIC 1 WATT POWER AMPLIFIER With Power Detector, 37 - 40 GHz

Gain & Return Loss

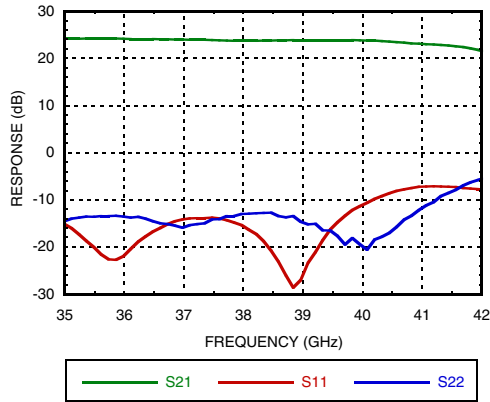

Gain vs. Temperature

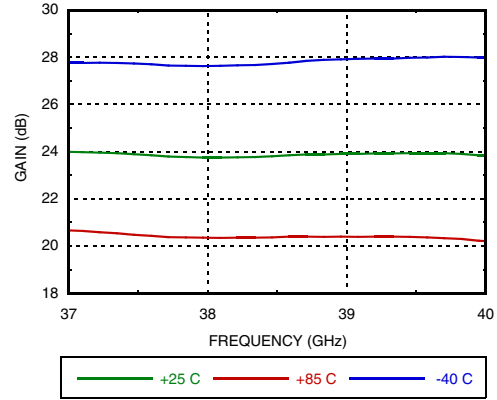

Input Return Loss vs. Temperature

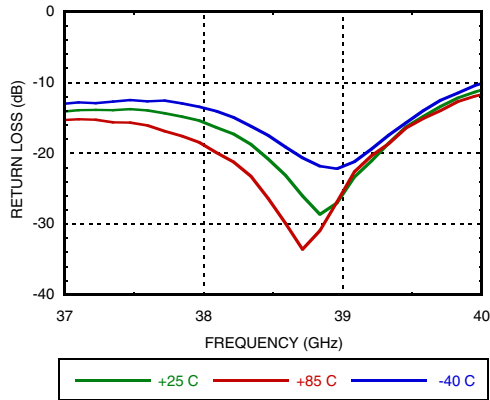

Output Return Loss vs. Temperature

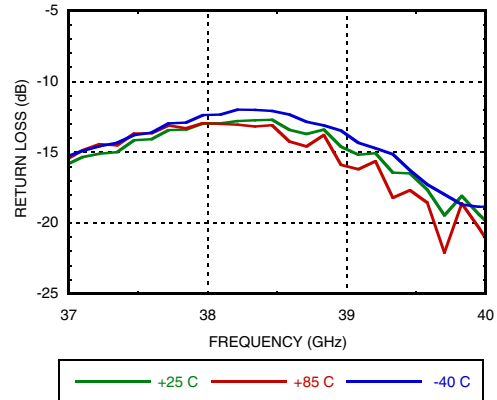

P1dB vs. Temperature

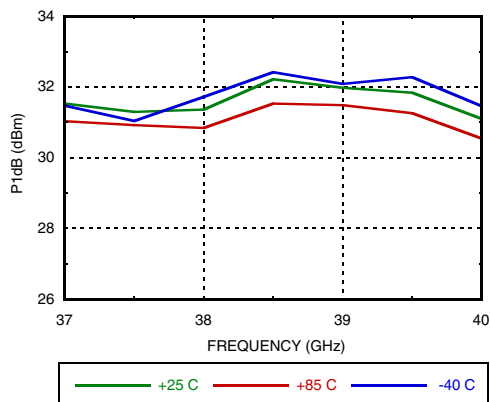

P1dB vs. Supply Voltage

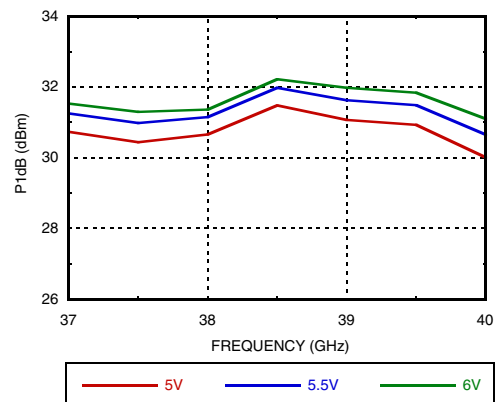



GaAs pHEMT MMIC 1 WATT POWER AMPLIFIER With Power Detector, 37 - 40 GHz

AMPLIFIERS - LINEAR & POWER - SMT

Psat vs. Temperature

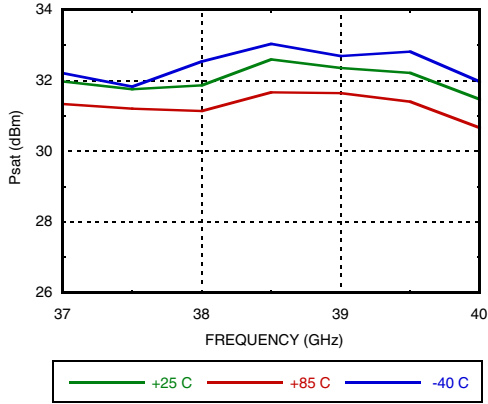

Psat vs. Supply Voltage

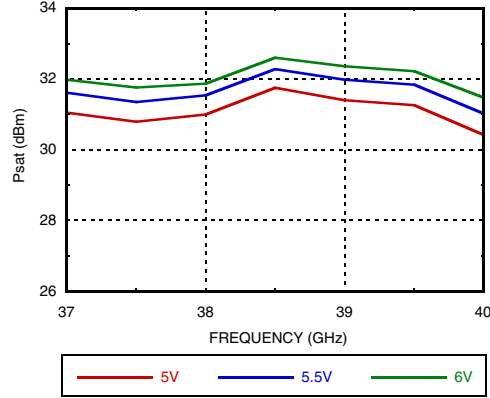

P1dB vs. Supply Current

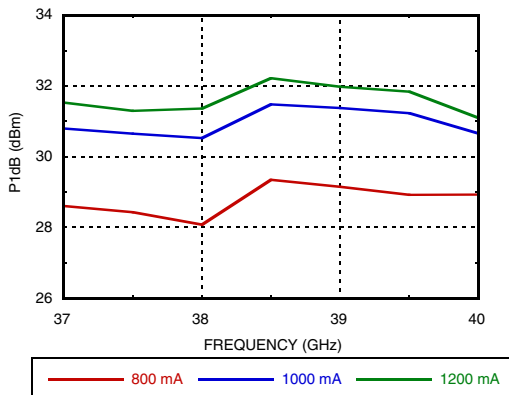

Psat vs. Supply Current

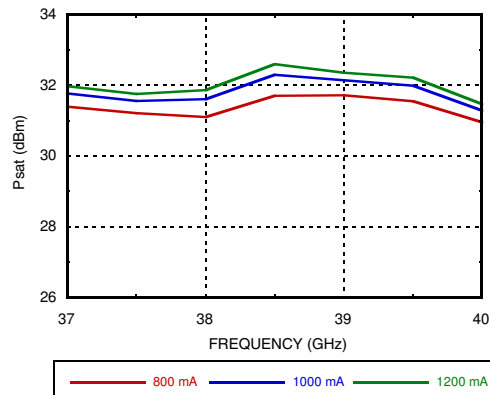

Output IP3 vs. Temperature, Pout/tone = +20 dBm

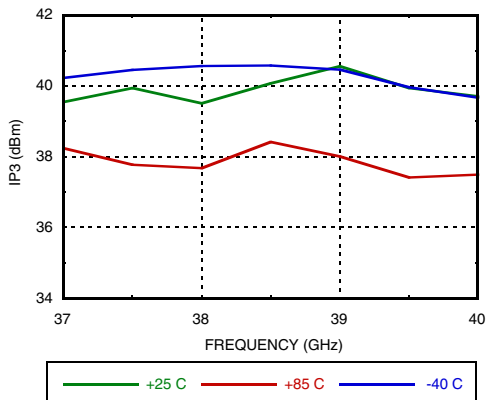

Output IP3 vs. Supply Current, Pout/tone = +20 dBm

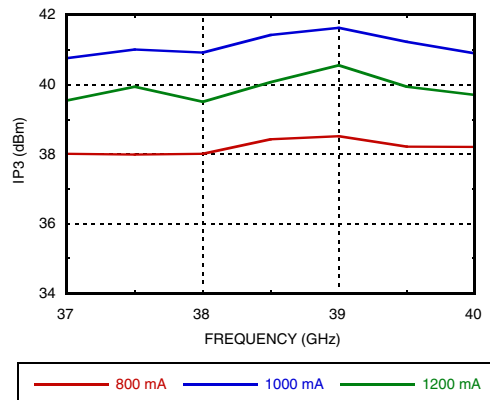



GaAs pHEMT MMIC 1 WATT POWER AMPLIFIER With Power Detector, 37 - 40 GHz

**Output IP3 vs. Supply Voltage,
Pout/tone = +20 dBm**

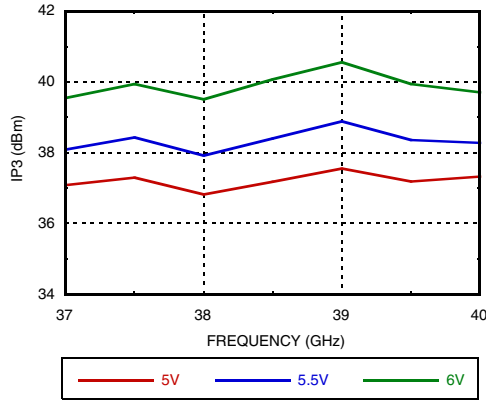

Output IM3 @ Vdd = +5V

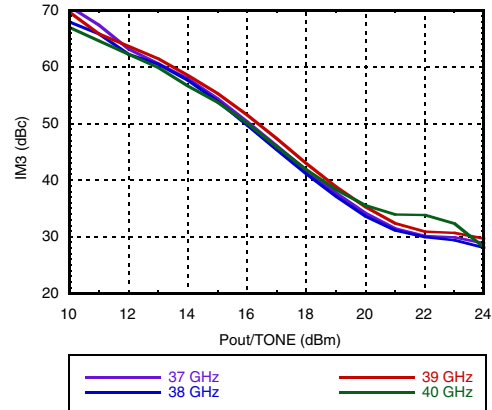

Output IM3 @ Vdd = +5.5V

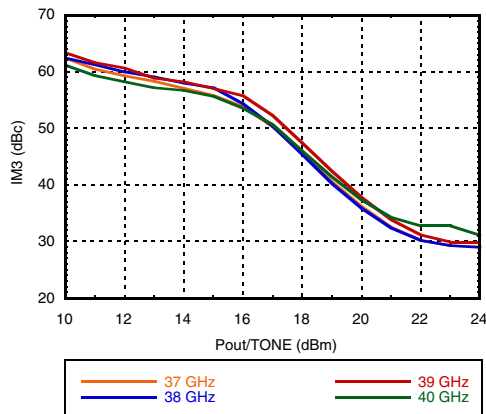

Output IM3 @ Vdd = +6V

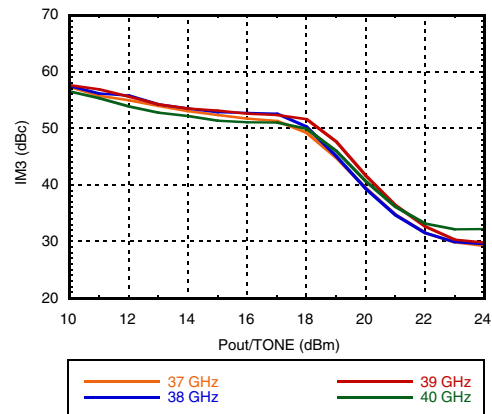

Power Compression @ 38 GHz

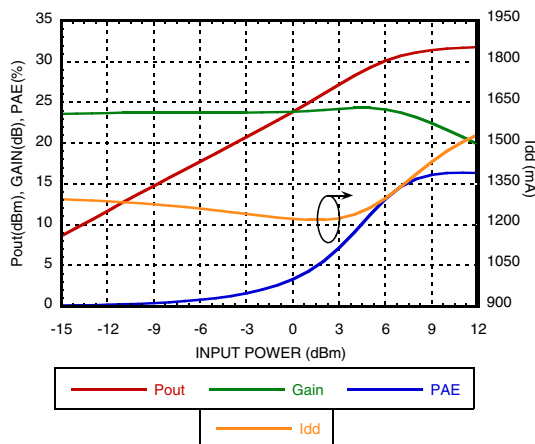

Power Compression @ 39 GHz

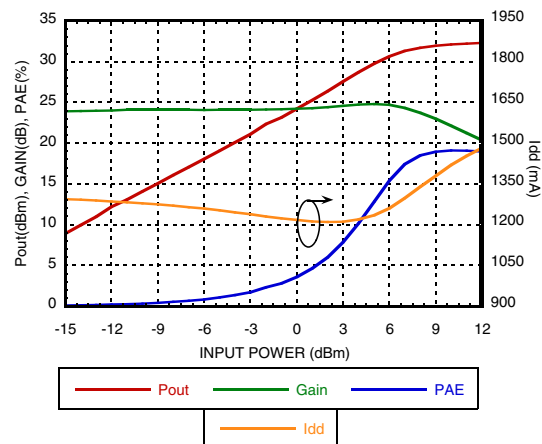



GaAs pHEMT MMIC 1 WATT POWER AMPLIFIER With Power Detector, 37 - 40 GHz

AMPLIFIERS - LINEAR & POWER - SMT

Reverse Isolation vs. Temperature

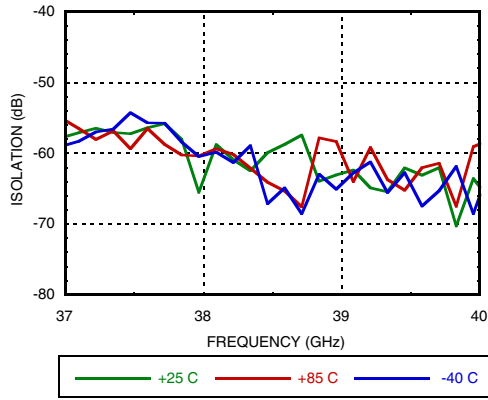

Gain & Power vs. Supply Current @ 38.5 GHz

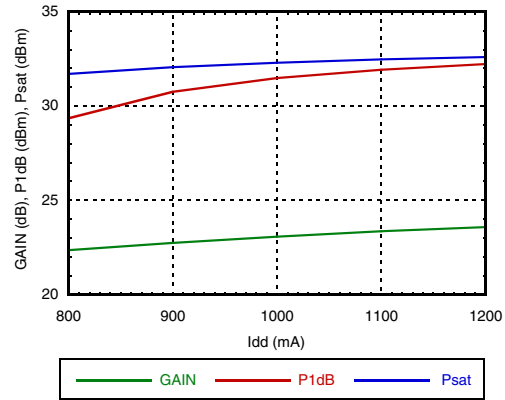

Gain & Power vs. Supply Voltage @ 38.5 GHz

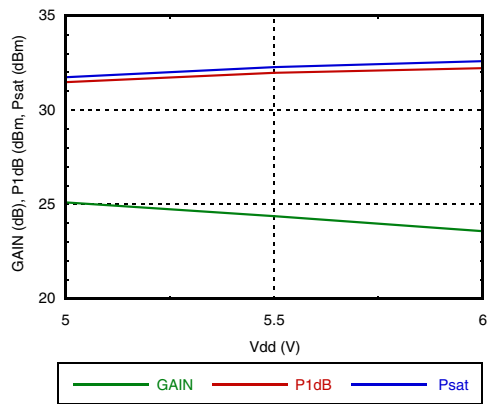

Power Dissipation

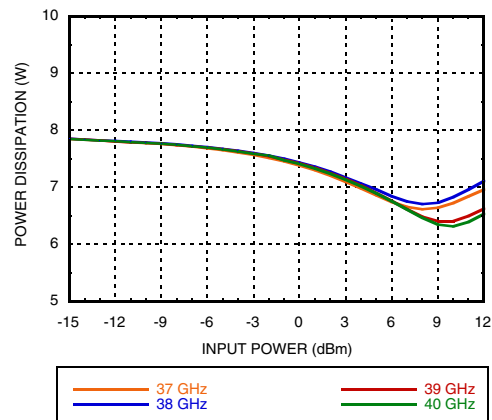

Detector Voltage vs. Temperature @ 38.5 GHz

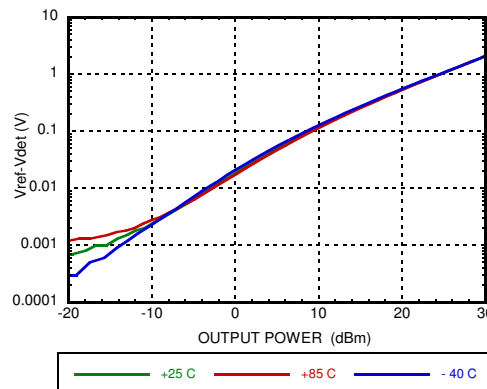



GaAs pHEMT MMIC 1 WATT POWER AMPLIFIER With Power Detector, 37 - 40 GHz

Absolute Maximum Ratings

Drain Bias Voltage (Vdd)	+7V
RF Input Power (RFIN)	+21 dBm
Channel Temperature	175 °C
Continuous Pdiss (T= 85 °C) (derate 95 mW/°C above 85 °C)	9.0 W
Thermal Resistance (channel to ground paddle)	10 °C/W
Operating Temperature	-65°C to +150°C
Storage Temperature	-40°C to 85°C
ESD Sensitivity (HBM)	Class 0, Passed 150V

Typical Supply Current vs. Vdd

Vdd (V)	Idd (mA)
+5	1200
+5.5	1200
+6	1200

Adjust Vgg1 to achieve Idd = 1200 mA



**ELECTROSTATIC SENSITIVE DEVICE
OBSERVE HANDLING PRECAUTIONS**

Outline Drawing

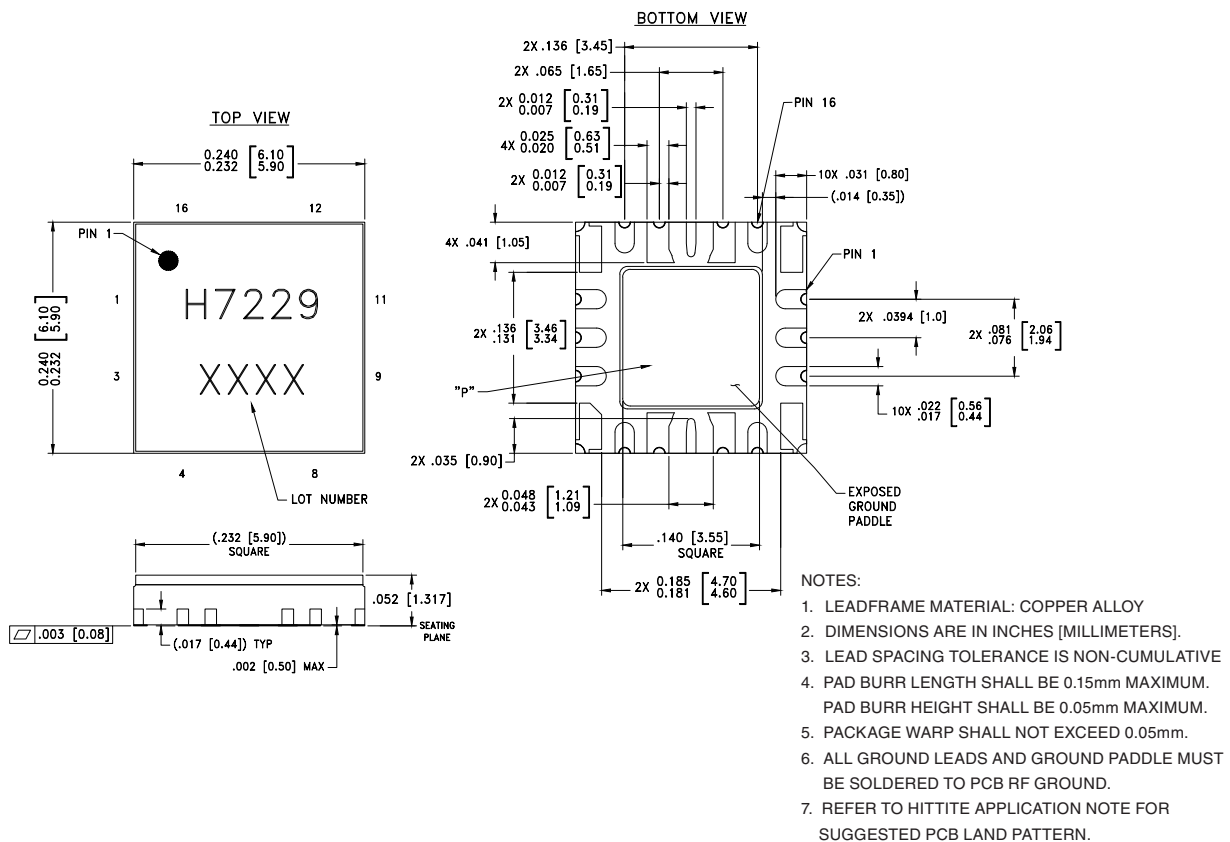

Package Information

Part Number	Package Body Material	Lead Finish	MSL Rating ^[2]	Package Marking ^[1]
HMC7229LS6	ALUMINA WHITE	Gold over Nickel	N/A ^[3]	H7229 XXXX

[1] 4-Digit lot number XXXX.



[2] Max peak reflow temperature of 260 °C.

[3] Not Applicable to air cavity packages.

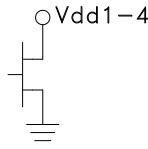
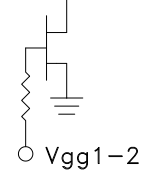

GaAs pHEMT MMIC 1 WATT POWER AMPLIFIER With Power Detector, 37 - 40 GHz

Pin Descriptions

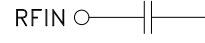
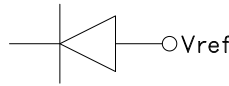
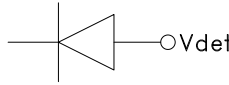
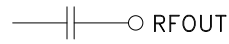
Pin Number	Function	Description	Pin Schematic
1, 2, 10, 11	Vdd1, Vdd3, Vdd4, Vdd2	Drain bias voltage. External bypass capacitors of 100 pF, 10 nF and 4.7 μ F are required for each pin.	
3, 9	Vgg1, Vgg2	Gate control for PA. Adjust Vgg to achieve recommended bias current. External bypass caps 100 pF, 10 nF and 4.7 μ F are required. Apply Vgg bias to either pin 3 or pin 9.	
4, 8	N/C	These pins are not connected internally; however, all data shown herein was measured with these pins connected to RF/DC ground externally.	
5, 7, 13, 15	GND	These pins and the exposed ground paddle must be connected to RF/DC ground.	
6	RF IN	This pin is AC coupled and matched to 50 Ohms.	
16	Vref	DC voltage of diode biased through external resistor used for temperature compensation of Vdet. See application circuit.	
12	Vdet	DC voltage representing RF output power rectified by diode which is biased through an external resistor. See application circuit.	
14	RF OUT	This pin is AC coupled and matched to 50 Ohms.	

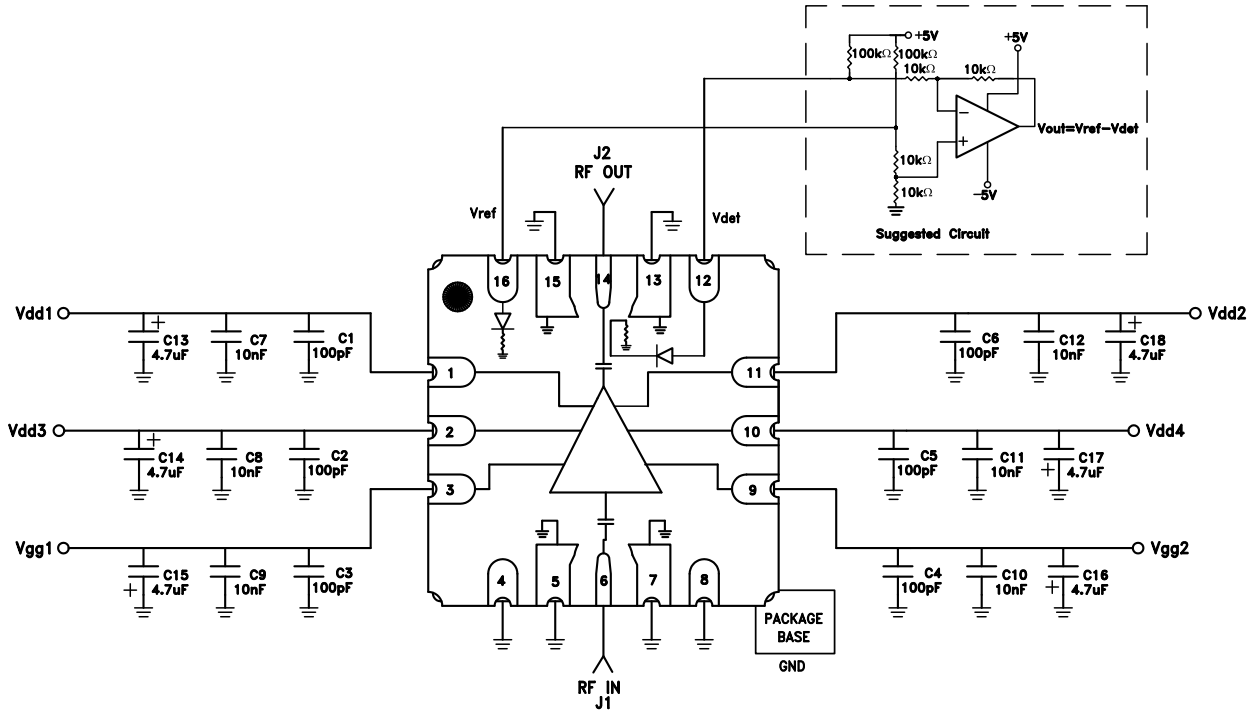
**GaAs pHEMT MMIC 1 WATT POWER AMPLIFIER
With Power Detector, 37 - 40 GHz**
Application Circuit



GaAs pHEMT MMIC 1 WATT POWER AMPLIFIER With Power Detector, 37 - 40 GHz

Evaluation PCB

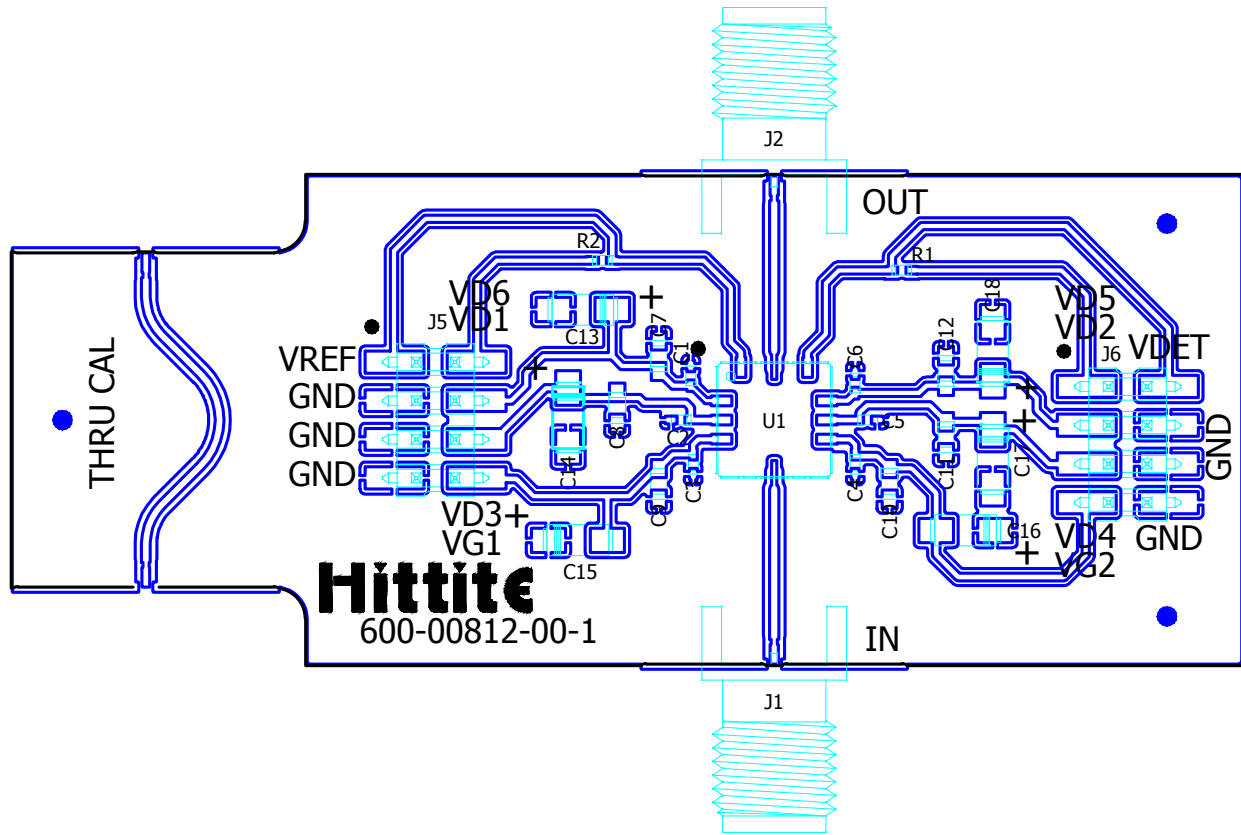

List of Materials for Evaluation PCB EV1HMC7229LS6 [1]

Item	Description
J1 - J2	"K" Connector, SRI
J5 - J6	DC Pin
C1 - C6	100 pF Capacitor, 0402 Pkg.
C7 - C12	10000 pF Capacitor, 0603 Pkg..
C13 - C18	4.7 uF Capacitor, Case A Pkg.
R1 - R2	40.2K Ohm Resistor, 0402 Pkg.
U1	HMC7229LS6 Amplifier
PCB [2]	600-00812-00 Evaluation Board

[1] Reference this number when ordering complete evaluation PCB

[2] Circuit Board Material: Rogers 4350 or Arlon 25FR

The circuit board used in the application should use RF circuit design techniques. Signal lines should have 50 Ohm impedance while the package ground leads and exposed paddle should be connected directly to the ground plane similar to that shown. A sufficient number of via holes should be used to connect the top and bottom ground planes. The evaluation circuit board shown is available from Hittite upon request.



**GaAs pHEMT MMIC 1 WATT POWER AMPLIFIER
With Power Detector, 37 - 40 GHz**

Notes

Компания «Life Electronics» занимается поставками электронных компонентов импортного и отечественного производства от производителей и со складов крупных дистрибьюторов Европы, Америки и Азии.

С конца 2013 года компания активно расширяет линейку поставок компонентов по направлению коаксиальный кабель, кварцевые генераторы и конденсаторы (керамические, пленочные, электролитические), за счёт заключения дистрибьюторских договоров

Мы предлагаем:

- Конкурентоспособные цены и скидки постоянным клиентам.
- Специальные условия для постоянных клиентов.
- Подбор аналогов.
- Поставку компонентов в любых объемах, удовлетворяющих вашим потребностям.
- Приемлемые сроки поставки, возможна ускоренная поставка.
- Доставку товара в любую точку России и стран СНГ.
- Комплексную поставку.
- Работу по проектам и поставку образцов.
- Формирование склада под заказчика.
- Сертификаты соответствия на поставляемую продукцию (по желанию клиента).
- Тестирование поставляемой продукции.
- Поставку компонентов, требующих военную и космическую приемку.
- Входной контроль качества.
- Наличие сертификата ISO.

В составе нашей компании организован Конструкторский отдел, призванный помогать разработчикам, и инженерам.

Конструкторский отдел помогает осуществить:

- Регистрацию проекта у производителя компонентов.
- Техническую поддержку проекта.
- Защиту от снятия компонента с производства.
- Оценку стоимости проекта по компонентам.
- Изготовление тестовой платы монтаж и пусконаладочные работы.



Тел: +7 (812) 336 43 04 (многоканальный)

Email: org@lifeelectronics.ru