



# Ribbon Cable Interconnect Solutions

RoHS  
Ready 



## Ribbon Cable Connector Selection Guide

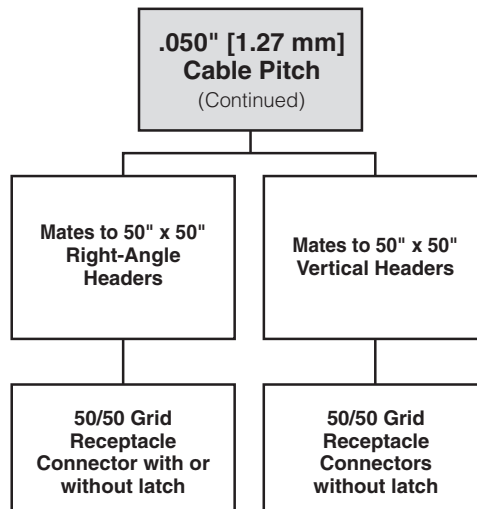
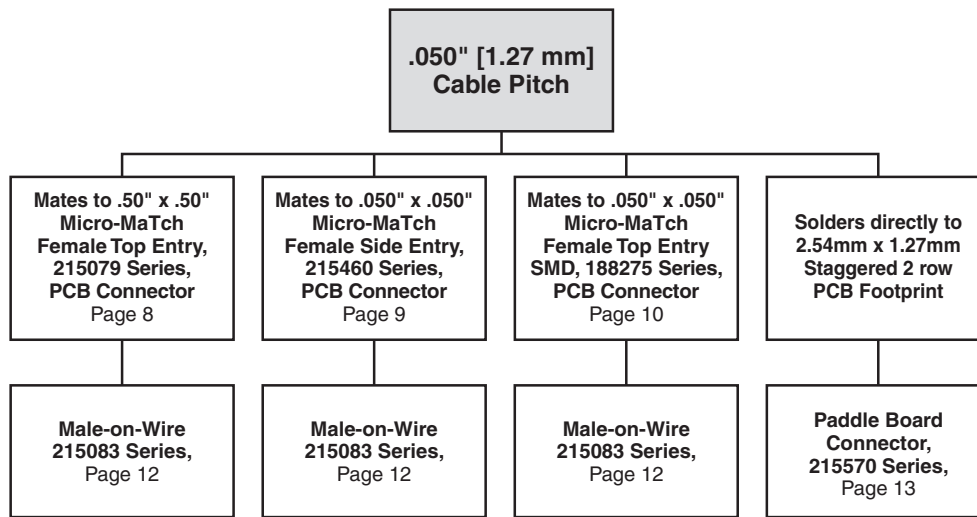

**Ribbon Cable Connector Selection Guide** (Continued)

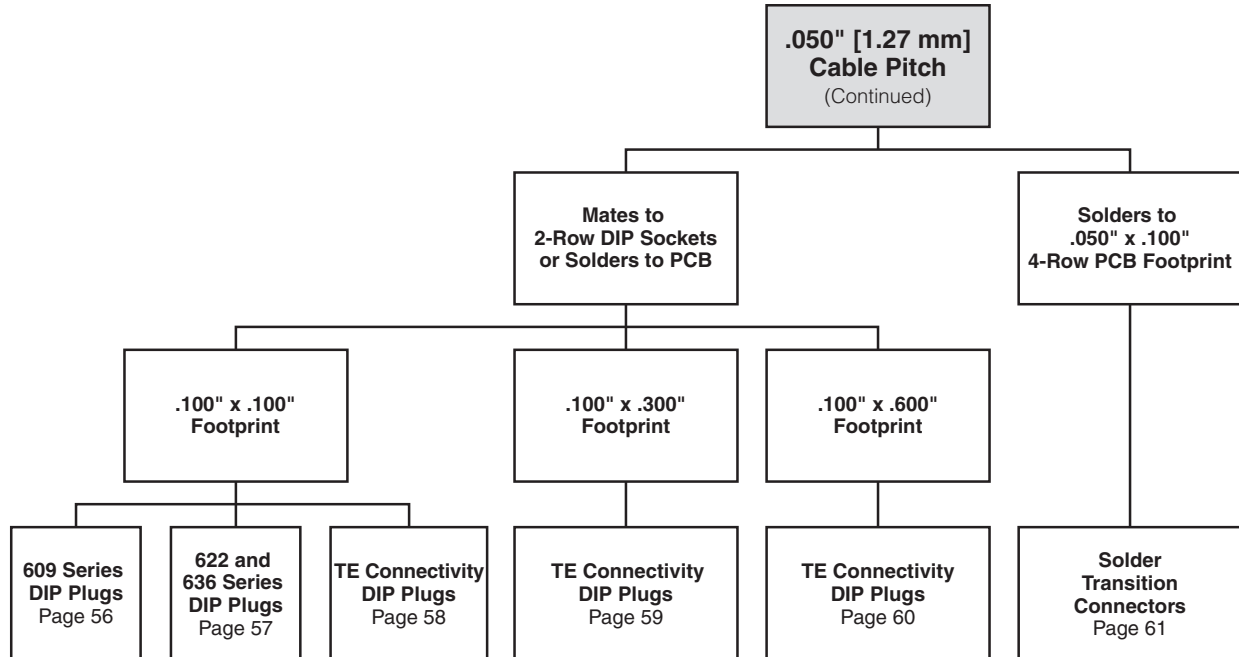
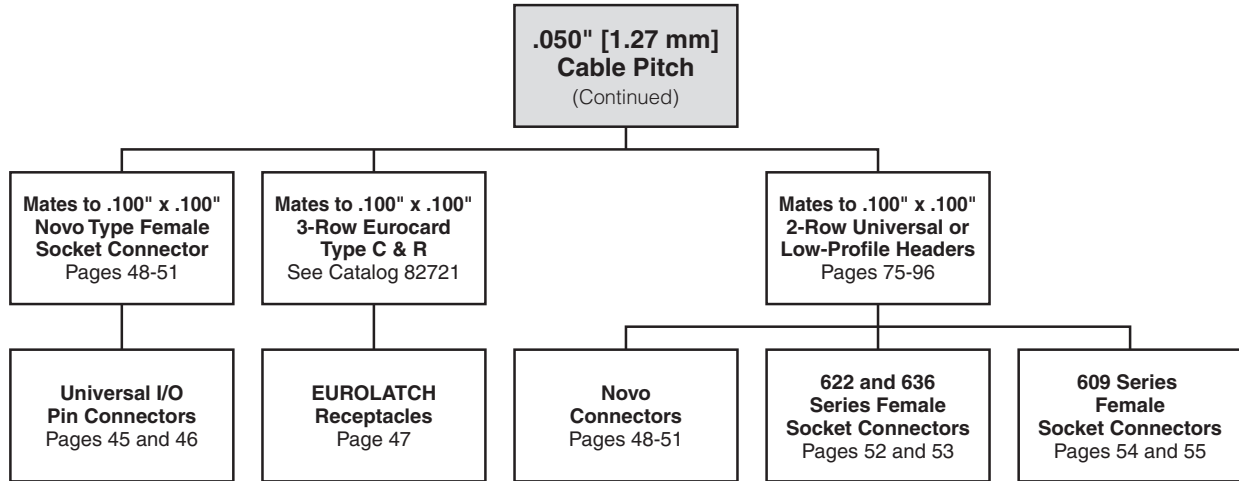

## Introduction

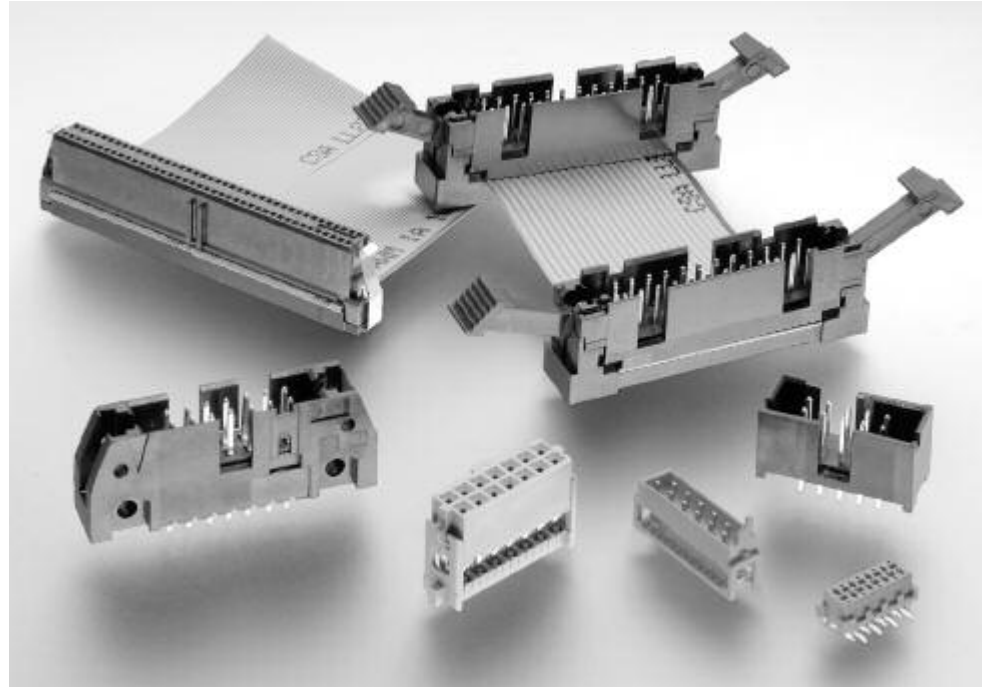

### Disclaimer

While TE has made every reasonable effort to ensure the accuracy of the information in this catalog, TE does not guarantee that it is error-free, nor does TE make any other representation, warranty or guarantee that the information is accurate, correct, reliable or current. TE reserves the right to make any adjustments to the information contained herein at any time without notice. TE expressly disclaims all implied warranties regarding the information contained herein, including, but not limited to, any implied warranties of merchantability or fitness for a particular purpose. The dimensions in this catalog are for reference purposes only and are subject to change without notice. Specifications are subject to change without notice. Consult TE for the latest dimensions and design specifications. © 2012, 2009, 1999, 1998, 1996, 1995, 1993, 1992, 1989, 1988, 1986, 1985, 1983, 1982, 1977, 1976, 1974 and 1973 Tyco Electronics Corporation. All Rights Reserved.

AMP, AMPLIMITE, AMPMODU, CHAMP, EUROLATCH, TE Connectivity and the TE connectivity (logo) are trademarks of the TE Connectivity Ltd. family of companies.

Other logos, product and Company names mentioned herein may be trademarks of their respective owners.

### Restriction on the use of Hazardous Substances (RoHS)

At TE Connectivity, we're ready to support your RoHS requirements. We've assessed more than 1.5 million end items/components for RoHS compliance, and issued new part numbers where any change was required to eliminate the restricted materials. Part numbers in this catalog are identified as:

**RoHS Compliant** — Part numbers in this catalog are RoHS Compliant, unless marked otherwise. These products comply with European Union Directive 2002/95/EC as amended 1 January 2006 that restricts the use of lead, mercury, cadmium, hexavalent chromium, PBB, and PBDE in certain electrical and electronic products sold into the EU as of 1 July 2006.

NOTE: For purposes of this Catalog, included within the definition of RoHS Compliant are products that are clearly "Out of Scope" of the RoHS Directive such as hand tools and other non-electrical accessories.

NOTE: Information regarding RoHS compliance is provided based on reasonable inquiry of our suppliers and represents our current actual knowledge based on the information provided by our suppliers. This information is subject to change. For latest compliance status, refer to our website referenced at right.

### Getting the Information You Need

Our comprehensive on-line RoHS Customer Support Center provides a forum to answer your questions and support your RoHS needs. A RoHS FAQ (Frequently Asked Questions) is available with links to more detailed information. You can also submit RoHS questions and receive a response within 24 hours during a normal work week. The Support Center also provides:

- Cross-Reference from Non-compliant to Compliant Products
- Ability to browse RoHS Compliant Products in our on-line catalog
- Downloadable Technical Data Customer Information Presentation
- More detailed information regarding the definitions used above
- So whatever your questions when it comes to RoHS, we have the answers at [www.te.com/leadfree](http://www.te.com/leadfree)

RoHS  
Customer  
Support  
Center

## Introduction (Continued)

**Mass termination capabilities of the ribbon cable connectors** have helped make ribbon cable, and particularly .050 [0.127] centerline cable, popular within the Electronics Industry. The ability to terminate up to 64 conductors simultaneously, without stripping or otherwise preparing the cable, presents obvious labor savings.

**Ribbon Cable Connectors** are wire-to-board devices used to make the transition between cable and pc board circuitry. They find heavy use within equipment to connect one board to another or one subsystem to another. The connectors are also used in input/output applications, connecting different pieces of equipment.

**Ribbon Cable Solutions** are available on three separate cable centerline spacings. They include:

**.025 [0.64] Centerlines**

- System 50 receptacles
- System 50 paddleboards
- Pin headers

**.039 [1.00] Centerlines**

- 2.0 mm receptacles
- Breakaway pin headers

**.050 [1.27] Centerlines**

- 50/50 Grid connectors
- Micro-MaTch connectors
- Novo Receptacle connectors
- DIP plugs
- EUROLATCH receptacle connectors per DIN 41612 and IEC 603-2
- Pin Headers

**System 50 ribbon cable receptacles** will terminate cable on .025 [0.64] centerlines. They are available in select sizes from 20 thru 100-positions, and accept wire size range 30 AWG [0.05 mm<sup>2</sup>] solid or stranded wire and 32 AWG [0.03 mm<sup>2</sup>] stranded pvc insulated wire. Housing and cover are made of high temperature tolerant thermoplastic material, black, UL 94V-0 rated. A single mating beam, phosphor bronze contact provides the interconnect between the con-

ductor and the .015<sup>2</sup> [0.38<sup>2</sup>] posts on .050 x .100 [1.27 x 2.54] grid. Also available in paddleboard configurations.

**2.0 mm [.079] ribbon cable receptacles**

feature contacts on a true 2.0 mm [.079 in.] mating grid for 1.0 mm [.039 in.] pitch ribbon cable. Select configurations are available between 8 and 50-positions. Receptacles feature insulation displacement contacts (IDC).

**50/50 Grid connectors**

Although AMPMODU 50/50 Grid Vertical Headers and Receptacles are designed for parallel board-to-board stacking in high density applications, Right-angle board-to-board and cable-to-board applications are also possible since the vertical receptacles also mate with non-latching right-angle headers and the vertical headers also mate with non-latching cable connectors.

**Micro-Match connectors**

Miniaturization and the trend towards higher density of electronic functions on a substrate led to the introduction of Micro-MaTch. The system offers a range of board and wire connectors, enabling a variety of wire-to-

board and board-to-board interconnections. Its design prevents the traditional failure mode in tin-plated connections, fretting corrosion. An additional positioning spring in the female part absorbs relative movements caused by vibrations and thermal expansion between male and female contacts. By preventing movements on the contact spot, a gas tight connection can be guaranteed under all circumstances.

**Novo receptacles**

feature two rows of contacts on .100 x .100 [2.54 x 2.54] centers on selected sizes of 10 thru 64-positions and mate with .025 [0.64] square or round posts. The Novo tuning-fork contact offers a military-approved design, at an affordable cost. Polarization options include military, center and military, or dual bar.

**DIP (Dual In-Line Package) plugs**

provide a permanent connection of ribbon cable to a pc board or mating to DIP sockets. Using the same centerline dimensions as DIP integrated circuits, DIP plugs offer space efficiency and a low profile of .253 [6.43].

**Need more information?**

Call Technical Support at the numbers listed below.

Technical Support is staffed with specialists well versed in all TE products. They can provide you with:

- Technical Support
- Catalogs
- Technical Documents
- Product Samples
- TE Authorized Distributor Locations



## Table of Contents

<b>Ribbon Cable Connector Selection Guide</b> .....	2, 3
<b>.025 [0.64] Centerline Ribbon Cable Connectors</b>	
System 50 Connectors .....	8-12
Cable-to-Board Connectors .....	8, 9, 12
Board-to-Board Connectors .....	10, 11
Ultra ATA Bus Connectors .....	13-15
<b>.039 [1.00] Centerline Ribbon Cable Connectors</b>	
2 mm [.079] Receptacle Connectors .....	16, 17
<b>AMPMODU 50/50 Grid Connector System</b>	
Introduction .....	18
Board-to-Board Vertical Receptacles and Headers .....	19
Board-to-Board Vertical Receptacles, Double Row, .050 x .050 [1.27 x 1.27] Centers .....	20
Board-to-Board Vertical Headers, Double Row, .050 x .050 [1.27 x 1.27] Centers . . .	21
Recommended PC Board Layouts for Vertical Connectors .....	22
Board-to-Board Right-Angle Headers .....	23
Board-to-Board Right-Angle Headers, Double Row, .050 x .050 [1.27 x 1.27] Centers .....	24
Cable-to-Board Connectors .....	25
Cable-to-Board Receptacle Connectors, Double Row, .050 x .050 [1.27 x 1.27] Centers .....	26
Terminating Covers for Cable Connectors .....	27
Application Tooling for Cable Connectors .....	28
Performance Specifications .....	29
Technical Documents .....	29
<b>Micro-MaTch Connector System</b>	
Miniature Connector System .....	30
System Overview/Technical Data .....	31
Applications (3 Dimensions) .....	32
Applications (2 Dimensions) .....	33
Female-on-Board Connector, Top Entry .....	34
Female-on-Board Connector, Side Entry .....	35
Female-on-Board Connector Surface Mount Device (SMD) .....	36
Male-on-Board Connector .....	37
Male-on-Wire Connector .....	38
Paddle Board Connector .....	39
Crimp On Snap In (COSI) Connector .....	40
Specials .....	41
Application Tooling .....	42, 43
Lead Assembly and Sample Box .....	44
<b>.050 [1.27] Centerline Ribbon Cable Connectors</b>	
Universal I/O Pin Connectors without Mounting Ears .....	45
Universal I/O Pin Connectors with Slotted Mounting Ears .....	46
EUROLATCH Receptacles 64-Position (Three-Row Housings, Two Rows Loaded) . . .	47
Novo Connectors .....	48-51
Military Polarized, .100 x .100 [2.54 x 2.54] Centers .....	49
Center and Military Polarized, .100 x .100 [2.54 x 2.54] Centers .....	50
Dual Polarized, .100 x .100 [2.54 x 2.54] Centers .....	51
Female Socket Connectors, .100 x .100 [2.54 x 2.54] Centers, 622 and 636 Series . . .	52, 53
Female Socket Connectors, .100 x .100 [2.54 x 2.54] Centers, 609 Series .....	54, 55
DIP Plugs, .100 x .100 [2.54 x 2.54] Centers, 609 Series .....	56
DIP Plugs, .100 x .100 [2.54 x 2.54] Centers, 622 Series .....	57

**Table of Contents** (Continued)

**.050 [1.27] Centerline Ribbon Cable Connectors** (Continued)

DIP Plugs, .100 x .100 [2.54 x 2.54] Centers . . . . . 58

DIP Plugs, .100 x .300 [2.54 x 7.62] Centers . . . . . 59

DIP Plugs, .100 x .600 [2.54 x 15.24] Centers . . . . . 60

4-Row PCB Solder Transition Connectors . . . . . 61

1-Row Horizontal Receptacle . . . . . 62

**Accessories**

Flexible Pull Tabs . . . . . 63

Universal I/O Latches . . . . . 63

Military Polarizers . . . . . 63

Keying Plugs . . . . . 64

Strain Relief for 622 Series DIP Plugs . . . . . 65

Pull Loops, Permanent (For Receptacles and Pin Connectors) . . . . . 66

Strain Relief for Universal I/O without Mounting Ears . . . . . 67

Strain Relief for 609 Series (Tulip Contact) Female Socket Connectors . . . . . 67

Strain Relief for Novo and Ultra ATA . . . . . 68

Strain Relief for 2 mm . . . . . 68

Strain Relief for 622 and 636 Series Female Socket Connectors . . . . . 69

**Application Tooling** . . . . . 70-74

**Low Profile Headers** . . . . . 75-83

Low Profile Pin Headers, Center and Dual Polarized, .100 x .100 [2.54 x 2.54] Centerlines . . . . . 76, 77

Low Profile Pin Headers, Center and Dual Polarized, .100 x .100 [2.54 x 2.54] Centerlines and “Kinked” Solder Tails for PCB Retention . . . . . 78, 79

IDC Low Profile Ejection Style Pin Headers with Die Cast Ejection Latches, Military and Center Polarized, .100 x .100 [2.54 x 2.54] Centerlines . . . . . 80, 81

IDC Low Profile Ejection Style Pin Headers, Center Polarized, .100 x .100 [2.54 x 2.54] Centerlines . . . . . 82, 83

**Universal Ejection Style Pin Headers and Pinless Headers**

Universal Ejection Style Pin Headers, Military, Center and Dual Polarized, .100 x .100 [2.54 x 2.54] Centerlines . . . . . 84-86

Universal Ejection Style Pin Headers, ACTION PIN Contacts, Military, Center and Dual Polarized, .100 x .100 [2.54 x 2.54] Centerlines . . . . . 87, 88

Universal Ejection Style Pin Headers, Military, Center and Dual Polarized, .100 x .100 [2.54 x 2.54] Centerlines, Right-Angle . . . . . 89-91

Universal Ejection Style Pinless Headers, Military, Center and Dual Polarized, .100 x .100 [2.54 x 2.54] Centerlines . . . . . 92, 93

Universal Ejection Style Pin Headers, with PCT Housing, .100 x .100 [2.54 x 2.54] Centerlines, .025 [0.64] Sq. Posts (Mating End) . . . . . 94, 95

Latches for Ejection Style Universal Pin Headers and Pinless Headers . . . . . 96

**Cable Solutions** . . . . . 97, 98

**Part Number Index** . . . . . 99

## System 50 Cable-to-Board Connectors, .025 [0.64] Centerline Ribbon Cable

### Product Facts

- Preassembled housing and cover
- One-step termination
- End and daisy chain termination
- Positive end latching of connector to universal header
- Terminates 30 AWG [0.05 mm<sup>2</sup>] solid or stranded and 32 AWG [0.03 mm<sup>2</sup>] stranded .025 [0.64] centerline ribbon cable with PVC insulation
- Connectors are RoHS compliant
- Recognized under the Component Program of the Underwriters Laboratories, Inc. UL File No. E28476
- Certified by the Canadian Standards Association, File No. LR 7189

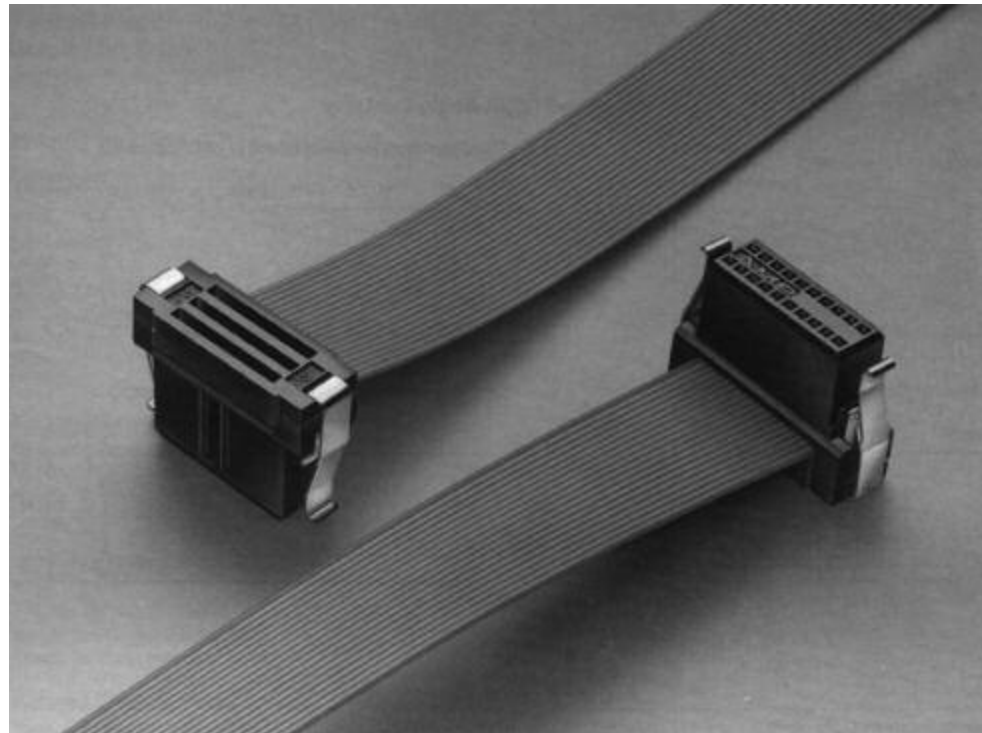

The System 50 Ribbon Cable connector is a receptacle connector that will terminate ribbon cable on .025 [0.64] centerlines. It is available in select sizes from 10 to 100 positions and will accommodate 30 AWG [0.05 mm<sup>2</sup>] solid or stranded and 32 AWG [0.03 mm<sup>2</sup>] stranded

conductors with PVC cable insulation.

The housing and cover are of a high temperature tolerant thermoplastic (black) with a UL 94V-0 rating. A phosphor bronze single mating beam contact provides the interconnect between the conductor and the .015 [0.38] square posts

on the .050 x .100 [1.27 x 2.54] grid. The contacts are plated with 30 gold duplex plating. The latching feature is located on the receptacle, not the header, and saves board space and eliminates future problems of "latch height compatibility."



## System 50 Cable-to-Board Connectors, .025 [0.64] Centerline Ribbon Cable (Continued)

### Double Row Receptacle



#### Material and Finish

**Housing** — Black thermoplastic, UL 94V-0 rated

**Latches** — Stainless steel

**Contacts** — Phosphor bronze, plated 30 microinch gold over nickel with tin in termination area

#### Related Product Data

**Mateable Connectors** — See AMP Catalog 82178  
See Part Numbers 104068 and 104069  
Series on pages 10 and 11

**Mates with Posts** — .015 [0.38] square, .125 [3.18] long, on .050 x .100 [1.27 x 2.54] grid

#### Technical Documents

**Product Specification**

108-1109

**Application Specification**

114-25029



No. of Pos.	Dimensions						Part Number
	A	B	C	D	E	F	
10	.510 12.95	.445 11.30	.225 5.72	.200 5.08	.096 2.44	.294 7.47	2-111196-5
14	.610 15.49	.545 13.84	.325 8.26	.300 7.62	.146 3.71	.394 10.01	2-111196-6
16	.660 16.76	.595 15.11	.375 9.52	.350 8.89	.171 4.34	.444 11.28	2-111196-7
20	.760 19.30	.695 17.65	.475 12.07	.450 11.43	.221 5.61	.544 13.82	1-111196-8
24	.860 20.32	.795 20.19	.575 14.61	.550 13.97	.271 6.88	.644 16.36	2-111196-8
26	.910 23.11	.845 21.46	.625 15.88	.600 15.24	.296 7.52	.694 17.63	2-111196-9
30	1.010 25.65	.945 24.00	.725 18.42	.700 17.78	.346 8.79	.794 20.17	1-111196-9
34	1.110 28.19	1.045 26.54	.825 20.96	.800 20.32	.396 10.06	.894 22.71	3-111196-0
40	1.260 32.00	1.195 30.35	.975 34.54	.950 24.13	.471 11.96	1.044 26.52	2-111196-0
44	1.360 34.54	1.295 32.89	1.075 27.31	1.050 26.67	.521 13.23	1.144 29.06	3-111196-1
50	1.510 38.35	1.445 36.70	1.225 31.12	1.200 30.48	.596 15.14	1.294 32.87	2-111196-1
60	1.760 44.70	1.695 43.05	1.475 37.47	1.450 36.83	.721 18.31	1.544 39.22	2-111196-2
64	1.860 47.24	1.795 45.59	1.575 40.00	1.550 39.37	.771 19.58	1.644 41.76	3-111196-2
68	1.960 49.78	1.895 48.13	1.675 42.55	1.650 41.91	.821 20.85	1.744 44.30	3-111196-4
72	2.060 52.32	1.995 50.67	1.775 45.08	1.750 44.45	.871 22.12	1.844 46.84	2-111196-3
80	2.260 57.40	2.195 55.75	1.975 50.17	1.950 49.53	.971 24.66	2.044 51.92	3-111196-3
100	2.760 70.10	2.695 68.45	2.475 62.87	2.450 62.23	1.221 31.01	2.544 64.62	2-111196-4

See Application Specification for termination tooling.

**Note:** All part numbers are RoHS compliant.

## System 50 Board-to-Board Connectors, Through-Hole Headers

### Shrouded, Double Row Vertical



#### Material and Finish

**Housing** — Black thermoplastic, UL 94V-0 rated

**Contacts** — Copper alloy, plated .000030 [0.00076] gold in mating area, .000150 [0.00381] tin on solder posts, with entire contact underplated .000050 [0.00127] nickel

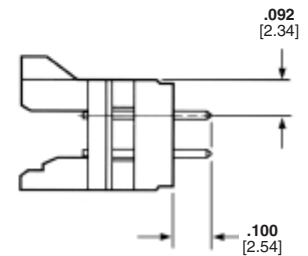
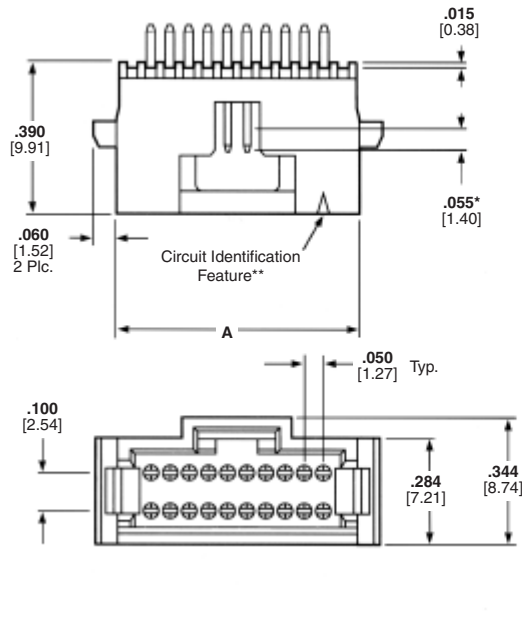

#### Related Product Data

**Mateable Receptacles** — page 9

#### Technical Documents

##### Product Specification

108-1093

##### Application Specification

114-25031

No. of Positions	Dim. A	Part Number
10	.380 9.65	5-104068-2
12	.430 10.92	5-104068-8
14	.480 12.19	5-104068-9
16	.530 13.46	6-104068-0
20	.630 16.00	5-104068-1
24	.730 18.54	6-104068-1
26	.780 19.81	6-104068-2
30	.880 22.35	5-104068-3

No. of Positions	Dim. A	Part Number
34	.980 24.89	6-104068-3
40	1.130 28.70	5-104068-4
44	1.230 31.24	6-104068-4
50	1.380 35.05	5-104068-5
60	1.630 41.40	5-104068-6
68	1.830 46.48	6-104068-8
72	1.930 49.02	6-104068-5
80	2.130 54.10	6-104068-6
100	2.630 66.80	6-104068-7

\*Point of measurement for gold thickness.

\*\*Circuit identification feature omitted on 8, 10, 12 and 14 position headers.

**Note:** All part numbers are RoHS compliant.

**System 50 Board-to-Board Connectors, Through-Hole Headers** (Continued)

**Shrouded, Double Row Right-Angle**



**Material and Finish**

**Housing** — Black thermoplastic, UL 94V-0 rated

**Contacts** — Copper alloy, plated .000030 [0.00076] gold in mating area, .000150 [0.00381] tin on solder posts, with entire contact underplated .000050 [0.00127] nickel

**Related Product Data**

**Mateable Receptacles** — page 9

**Technical Documents**

**Product Specification**  
108-1093

**Application Specification**  
114-25031

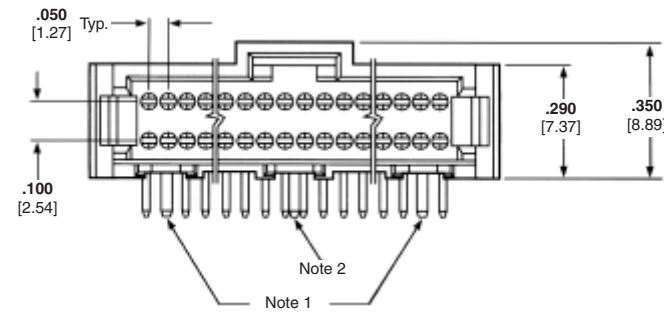
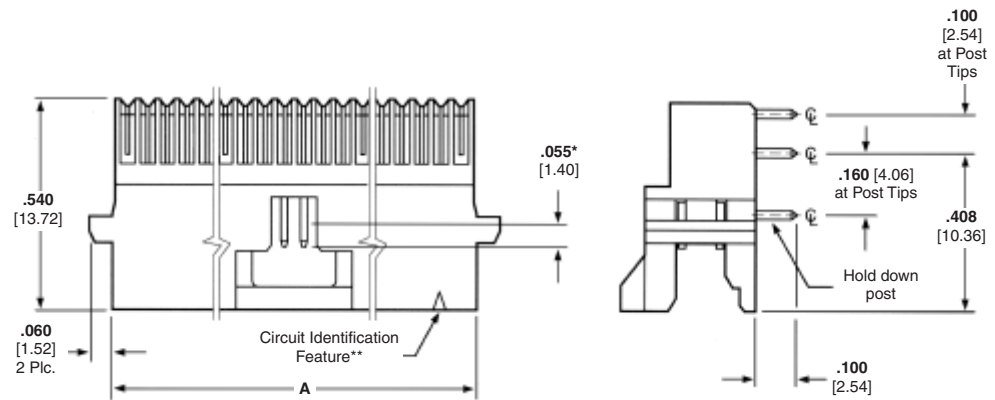

.025 [0.64] Centerline Ribbon Cable Connectors  
System 50 Board-to-Board Connectors

No. of Positions	Dim. A	Part Number
8	.330 8.38	5-104069-8
10	.380 9.65	5-104069-4
20	.630 16.00	5-104069-1
24	.730 18.54	6-104069-2
26	.780 19.81	6-104069-3
30	.880 22.35	5-104069-5
34	.980 24.89	6-104069-4

No. of Positions	Dim. A	Part Number
40	1.130 28.70	5-104069-6
50	1.380 35.05	5-104069-2
60	1.630 41.40	5-104069-7
68	1.830 46.80	6-104069-8
72	1.930 49.02	6-104069-6
80	2.130 54.10	5-104069-3
100	2.630 66.80	6-104069-7

\*Point of measurement for gold thickness.  
 \*\*Circuit identification feature omitted on 8, 10, 12 and 14 position headers.  
**Notes:** 1. Hold down posts located as shown for 16 through 100 position headers.  
 2. Hold down posts located as shown for 8 through 14 and 60 through 100 position headers.  
 3. All part numbers are RoHS compliant.

## System 50 Cable-to-Board Connectors, .025 [0.64] Centerline Ribbon Cable

### Paddleboard

#### Material and Finish

**Housing** — LCP thermoplastic, UL 94V-0 rated, black

**Cover** — Polyester, UL 94V-0 rated, black

**Contacts** — Phosphor bronze, plated .000100 [0.00245] min. tin over .000050 [0.00127] min. nickel underplating

#### Technical Documents

##### Product Specification

108-1109

##### Application Specification

114-25040

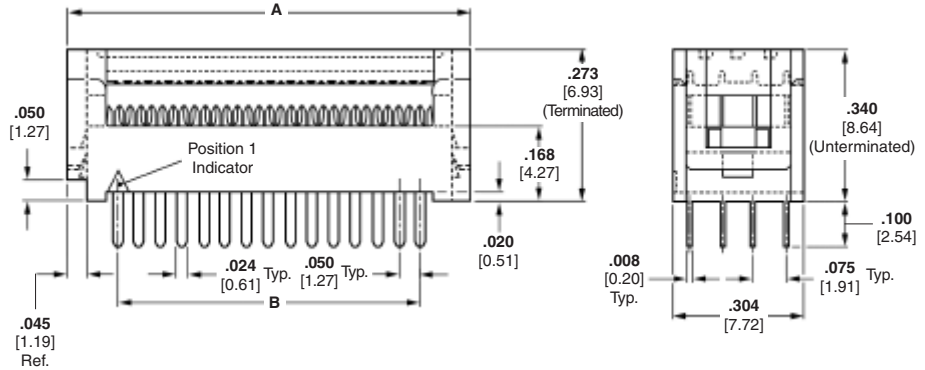

Printed Circuit Board Hole Layout #1



Printed Circuit Board Hole Layout #2

No. of Pos.	PCB Layout	Dimensions		Kinked Legs
		A	B	
10	1	.436 11.07	.200 5.08	5111595-1
14	1	.536 13.61	.300 7.62	5111595-2
16	2	.586 14.88	.350 8.89	5111595-3
20	2	.686 17.42	.450 11.43	5111595-4
24	2	.786 19.96	.550 13.97	5111595-5
26	1	.836 21.23	.600 15.24	5111595-6
28	2	.886 22.50	.650 16.51	2-5111595-0
30	1	.936 23.77	.700 17.78	5111595-7
34	1	1.036 26.31	.800 20.32	5111595-8
40	2	1.186 30.12	.950 24.13	5111595-9

No. of Pos.	PCB Layout	Dimensions		Kinked Legs
		A	B	
44	2	1.286 32.66	1.050 26.67	1-5111595-0
46	1	1.336 33.93	1.100 27.94	1-5111595-7
50	1	1.436 36.47	1.200 30.48	1-5111595-1
60	2	1.686 42.82	1.450 36.83	1-5111595-2
64	2	1.786 45.36	1.550 39.37	1-5111595-3
68	2	1.886 47.90	1.650 41.91	1-5111595-9
72	2	1.986 50.44	1.750 44.45	1-5111595-4
80	2	2.186 55.52	1.950 40.53	1-5111595-5
100	2	2.686 68.22	2.450 62.23	1-5111595-6

See Application Specification for termination tooling.

**Note:** All part numbers are RoHS compliant.

## Ultra ATA Bus Connectors, .025 [0.64] Centerline Ribbon Cable

### Product Facts

- IDC termination
- Backward compatible with current IDE Interfaces
- Improved signal integrity: 1 to 1 signal to ground ratio
- Improved crosstalk when compared to existing IDE Cable Assembly
- Color coded connectors for "System board," and "Master HDD" and "Slave HDD"
- Cable impedance 80 ohms
- Up to 3 connectors per cable assembly
- 15 microinches gold plating
- Recognized under the Component Program of the Underwriters Laboratories, Inc.  UL File No. E28476
- Certified by the Canadian Standards Association, File No. LR 7189 
- Terminates 30 AWG solid or stranded PVC insulated 80 conductor ribbon cable



Ultra ATA is the next generation IDE (Integrated Drive Electronics) bus. The current IDE bus has a maximum data transfer rate of about 16.5 MB/second. As the bus speeds and disk drive performances increase, the cable assembly between the motherboard and hard drive becomes a limiting factor in data transfer from the drive.

The Ultra ATA connector and cable assembly from TE provide the customer with improved electrical performance by creating a 1:1 signal-to-ground ratio. The connector design incorporates an IDC bus bar to common the 40 additional ground signals. The cable is .025" centerline PVC ribbon cable. The connector is fully backward compatible with existing 40-position headers with pin 20 removed on motherboards and disk drives.

The new connectors are color coded to identify:

1. system board connector
2. primary or master hard drive connector
3. slave drive connector

### Standard Issues

The Ultra ATA cable performance specification is part of the Small Form Factor Committee No. 8049. Compaq Computer and Western Digital are the major sponsors of the standard.

### Contacts Available:

- 80 position IDC contact terminations
- 40 signal contacts
- 40 ground terminations to special IDC bus bar



**Ultra ATA Bus Connectors, .025 [0.64] Centerline Ribbon Cable (Continued)**

**Related Product Data**

**Strain Relief** — Part Number 499252-1

**Mateable Headers** — page 15

**Material & Finish**

**Housing and Cover** — Thermoplastic, UL 94 V-0 rated, color per table

**Contacts** — Phosphor bronze, plated gold per table on mating end, .000050 [0.00127]min. tin in wire termination area, over .000050 [0.00127] min nickel on entire contact.

**Technical Documents**

**Product Specification**  
108-1740

**Application Specification**  
114-40056

See Application Specification for termination tooling.

**Accessories**

**Strain Relief** — page 68

**Keying Plug** — page 64

**Pull Loops** — page 66

**Pull Tabs** — page 63



Terminated View

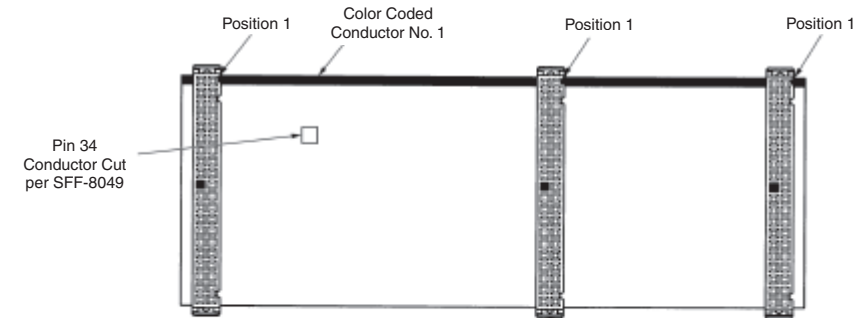
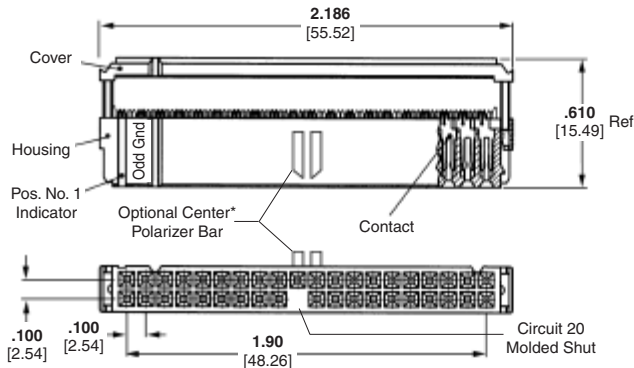

**Configuration A**

“System” Board Connector

“Master” or “Primary” Connector

“Slave” Connector

**Configuration B**

“System” Board Connector

“Slave” Connector

“Master” or “Primary” Connector

Connector Type	*Center & Military Polarized			Military Polarized		
	15µ" Gold	Housing Color	Cover Color	15µ" Gold	Housing Color	Cover Color
“System” Board	1658619-2	Blue	Black	1658618-2	Blue	Black
“Primary” or “Master”	1658619-1	Black	Black	1658618-1	Black	Black
“Slave”	1658619-3	Gray	Black	1658618-3	Gray	Black

**Notes:** 1. All connectors are “ODD GROUND” configuration, ie. all odd cable conductors are grounded. “EVEN GROUND” connectors are not available. See Customer Drawings for detailed electrical connection descriptions.  
2. All part numbers are RoHS compliant.

**Ultra ATA Bus Connectors, .025 [0.64] Centerline Ribbon Cable** (Continued)

**Ultra ATA  
Compatible Headers**

**Universal Headers — Pin 20 Omitted**

Post Type	Housing Material	Latch Type	Part Number	Contact Finish (Plating Code)	Solder Tail Length	Comments
Vertical	Nylon or PBT	Long	5111824-9	D	.110 2.79	
Vertical	Nylon or PBT	Short	6489700-1	B	.123 3.12	PP

**Legend:** PP — Polarization Peg

**Low Profile Headers — Pin 20 Omitted**

Post Type	Housing Material	Latch Type	Part Number	Contact Finish (Plating Code)	Solder Tail Length	Housing Color
Vertical	Nylon	None	1888188-1	A	.120 3.05	Black
Vertical	Nylon	None	1888188-2	B	.120 3.05	Black
Vertical	Nylon 6T	None	2-1734161-4	C	.122 3.10	Black
Vertical	Nylon 6T	None	2-1734161-5	C	.122 3.10	Blue
Vertical	Nylon	None	1734162-2	C	.110 2.79	Black
Vertical	Nylon	None	1734162-4	C	.110 2.79	Blue

**Plating Code A** — Duplex plated, gold flash on mating surfaces, .000100 [0.00254] min. tin on solder area, with entire post underplated .000050 [0.00127] min. nickel.

**Plating Code B** — Duplex plated, gold flash over palladium-nickel, .000015 [0.00038] min. total on mating surfaces, .000100 [0.00254] min. tin on solder area, with entire post underplated .000050 [0.00127] min. nickel **or** .000015 [0.00038] min. gold on mating surfaces, .000100 [0.00254] min. tin on solder area, with entire post underplated .000050 [0.00127] min. nickel.

**Plating Code C** — Gold flash over nickel underplate on entire post.

**Plating Code D** — Duplex plated, gold flash over palladium-nickel, .000030 [0.00076] min. total on mating surfaces, .000100 [0.00254] min. tin on solder area, with entire post underplated .000050 [0.00127] min. nickel **or** .000015 [0.00038] min. gold on mating surfaces, .000100 [0.00254] min. tin on solder area, with entire post underplated .000050 [0.00127] min. nickel.

**Note:** All part numbers are RoHS compliant.

## 2.0 mm [.079] Receptacle Connectors

### Product Facts

- True hard metric 2.0 x 2.0 [.079 x .079] mating grid for 1.0 [.039] pitch ribbon cable
- Wide selection of configurations, 8-50 positions
- Insulation displacement (IDC), beryllium copper contacts, duplex plated gold-over-nickel
- Top/bottom single beam contact orientation
- UL 94V-0 rated thermo-plastic components
- Assemblies are furnished preassembled with termination covers
- Optional polarization
- Optional strain relief available
- Connector assemblies packaged for ease of handling and protection
- Recognized under the Component Program of the Underwriters Laboratories, Inc. UL File No. E28476
- Certified by the Canadian Standards Association, File No. LR 7189



### Performance Data

- Durability** — 150 cycles
- Termination Resistance** — 25 milliohms max.
- Mating Force** — 1.67 N max. per contact
- Unmating Force** — 0.14 N min. per contact
- Operating Temperature** — -65°C to +105°C

### Technical Documents

- Product Specification**  
108-1372
- Application Specification**  
114-40038

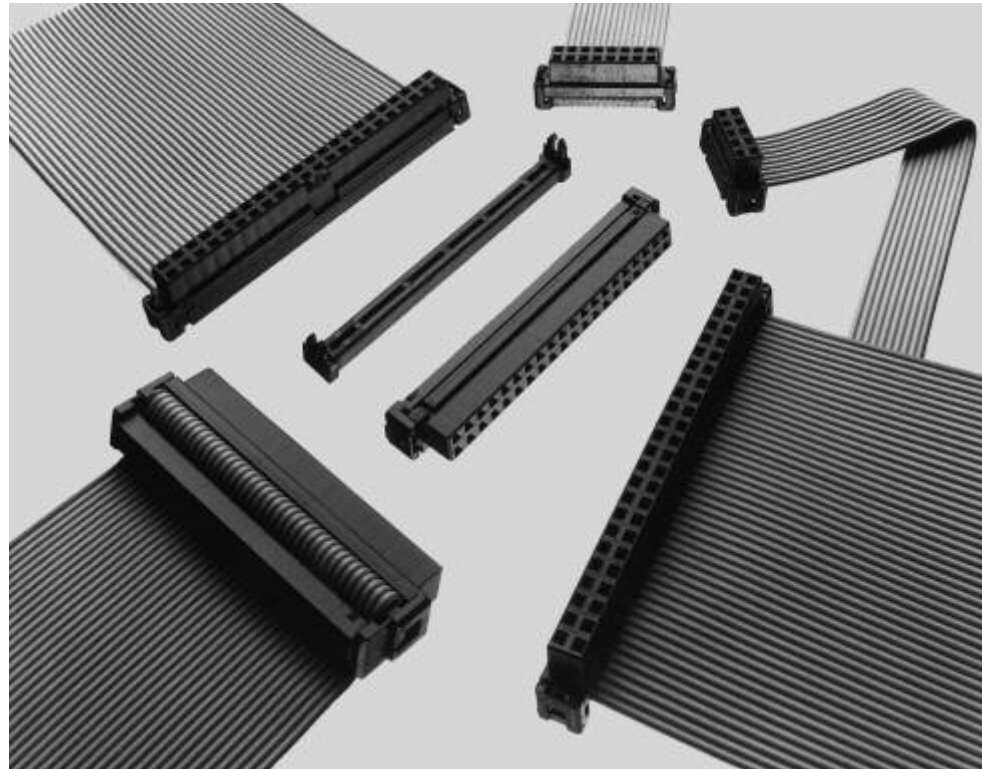

The 2.0 [.079] receptacle connector family features contacts on a true 2.0 x 2.0 [.079 x .079] mating grid for 1.0 [.039] pitch 28 AWG ribbon cable. A variety of configurations are available from 8 through 50 positions. This small, compact connector is finding wide acceptance throughout the electronic industry, particularly in the smaller laptop and notebook type computers with 63.5 [2.5] drives. Other areas of application include point-of-sale terminals, fax machines, photocopiers, printers, consumer electronics, and other computer peripheral equipment. These receptacles feature insulation displacement contacts (IDC) with a top/bottom single-beam contact orientation. Contacts are beryllium copper, duplex plated 0.00076 [.000030] gold

in the mating area and 0.00254 [.000100] min. tin on termination end, all over 0.00127 [.000050] nickel underplating. Contact mating area is 1.54 [.061] from the face of the housing and they accept 0.50mm [.0197] round or square posts.

Housings are made of UL 94V-0 rated polyester with optional center bar polarization. Complete assemblies are furnished preassembled with termination covers. The complete assembly presents a compact design only 5.2 [.203] wide over the termination cover by 4 [.157] deep by 4 [.157] wide mating end. Terminated height is 8.48 [.334]. Optional strain relief available. Assemblies are packaged for ease of handling and protection.

## 2.0 mm [.079] Receptacle Connectors, Non-Polarized and Center Polarized Bar

### Material and Finish

**Housing and Termination Cover** — UL 94V-0 rated polyester, black

**Contacts** — Beryllium copper, duplex plated 0.00076 [.000030] min. gold on mating end, 0.00013 [.000005] min. gold on termination end, all underplated 0.00127 [.000050] min. nickel

**Note:** Accepts 0.08-0.09mm<sup>2</sup> [28 AWG] ribbon cable, PVC insulated 1.00 [.039] pitch. See Application Specification for details.

### Technical Documents

**Product Specification**

108-1372

**Application Specification**

114-40038

**Mateable Connectors** — pages 9 and 12, or see Application Specification for header requirements

### Accessories

**Pull Loops** — page 66

**Keying Plugs** — page 64

**Strain Relief** — page 68

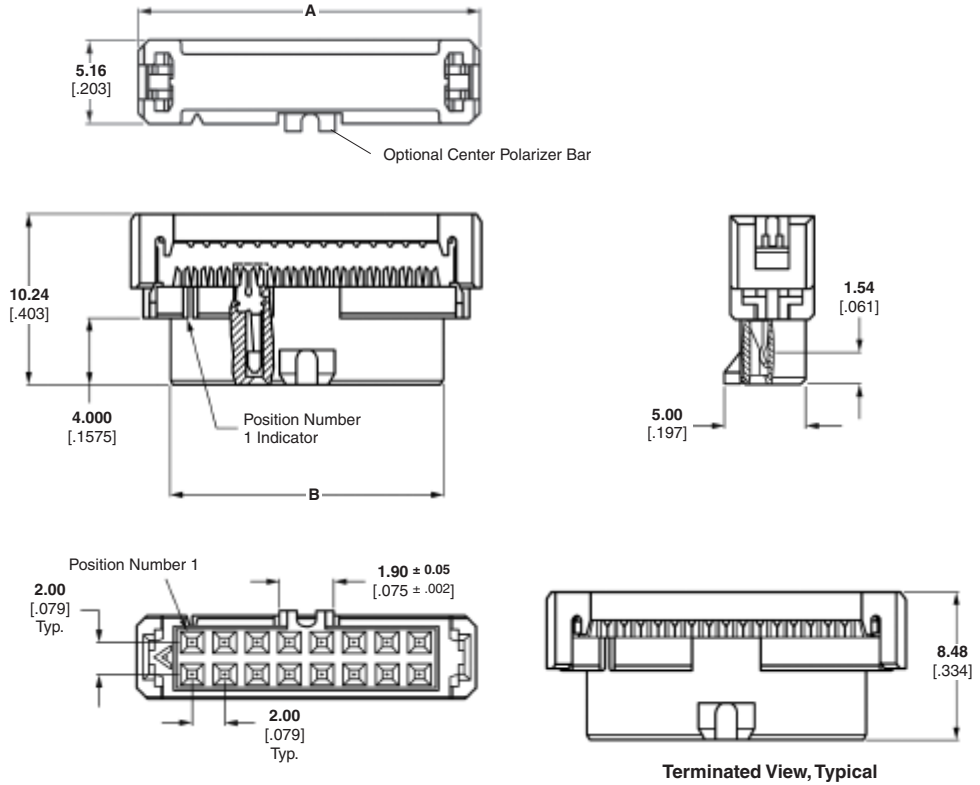

039 [1.00] Centerline Ribbon Cable Connectors  
.079 [2.00] Receptacle Connectors

No. of Positions	Dimensions		Center Polarized	Non-Polarized
	A	B		
8	13.18 .519	8.41 .331	3-111623-0	2-111626-4
10	15.16 .597	10.41 .410	1-111623-8	1-111626-7
12	17.15 .675	12.40 .488	3-111623-1	—
14	19.18 .755	14.40 .567	1-111623-9	1-111626-8
16	21.18 .834	16.41 .646	2-111623-0	2-111626-5
20	25.17 .991	20.40 .803	2-111623-1	1-111626-9
22	27.18 1.070	22.40 .882	2-111623-9	—
24	29.18 1.149	24.41 .961	2-111623-7	2-111626-6
26	31.17 1.227	26.42 1.040	2-111623-2	2-111626-7
30	35.18 1.385	30.40 1.197	2-111623-3	—
34	39.17 1.542	34.42 1.355	2-111623-8	2-111626-0
40	45.19 1.779	40.41 1.591	2-111623-4	2-111626-1
44	49.17 1.936	44.40 1.748	2-111623-5	2-111626-2
50	55.17 2.172	50.39 1.984	2-111623-6	2-111626-3

**Note:** All part numbers are RoHS compliant.

## AMPMODU 50/50 Grid Connector System

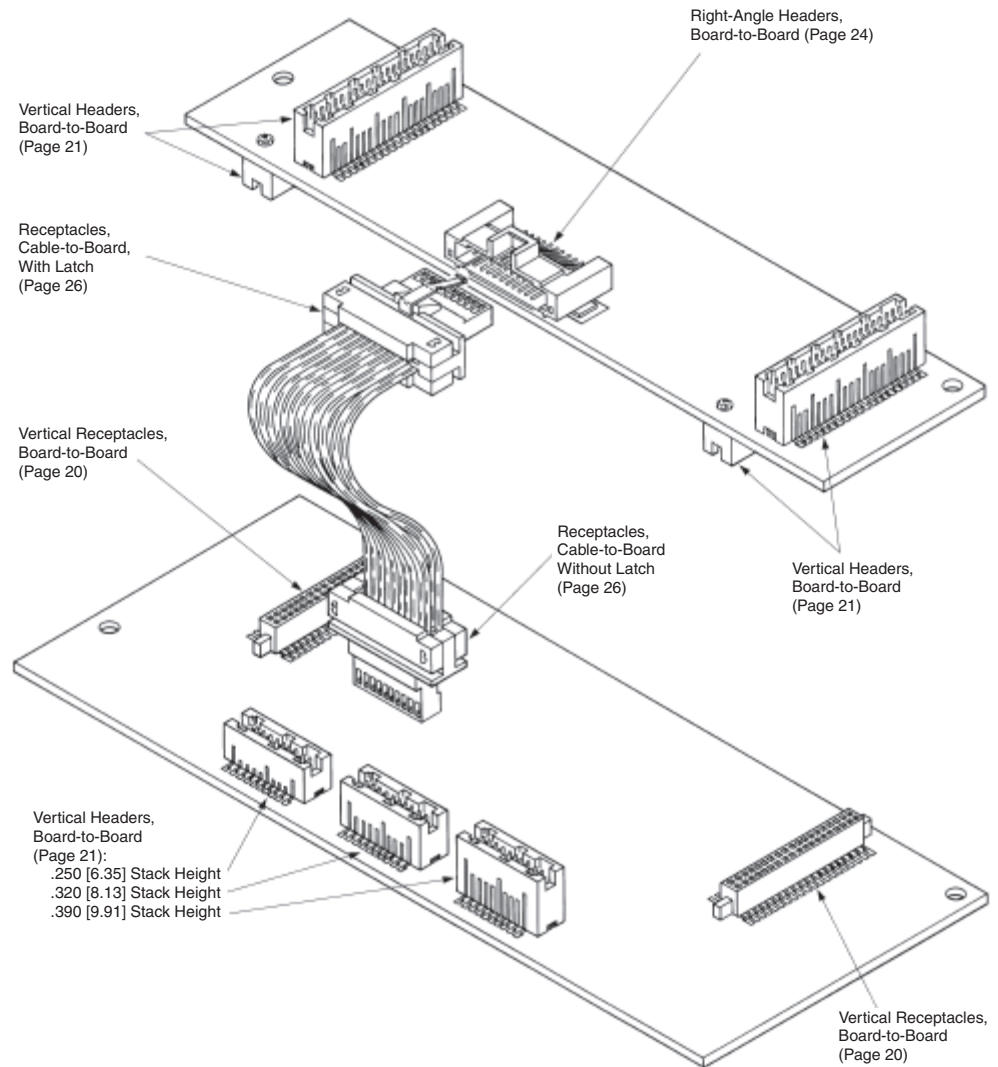

**Produced under a Quality Management System certified to ISO 9001**



A copy of the certificate is available upon request.





## Board-to-Board Vertical Receptacles and Headers

### Product Facts

- Surface-mount products for parallel board-to-board applications, as well as right-angle board-to-board and cable-to-board applications
- High density .050 x .050 [1.27x1.27] centerline grid
- Three board-to-board stack heights: .250 [6.35], .320 [8.13] and .390 [9.91]
- Non-protrusive metallic holddowns
- Reliable dual beam receptacle contacts for redundant contact
- Duplex plated receptacle and post contacts; gold plated on mating areas, tin plated on tails
- Compatible with standard surface-mount processing (VPR and IR)
- Receptacle and header allow for drainage of processing fluids
- Tape and reel packaging available. Contact TE for details
- Polarized header and receptacle assemblies
- Sizes of 10, 20, 30, 40, 50, 60, 70, 80 and 100 positions
- Recognized under the Component Program of Underwriters Laboratories Inc., File No. E28476 
- Certified by Canadian Standards Association File No. LR7189 

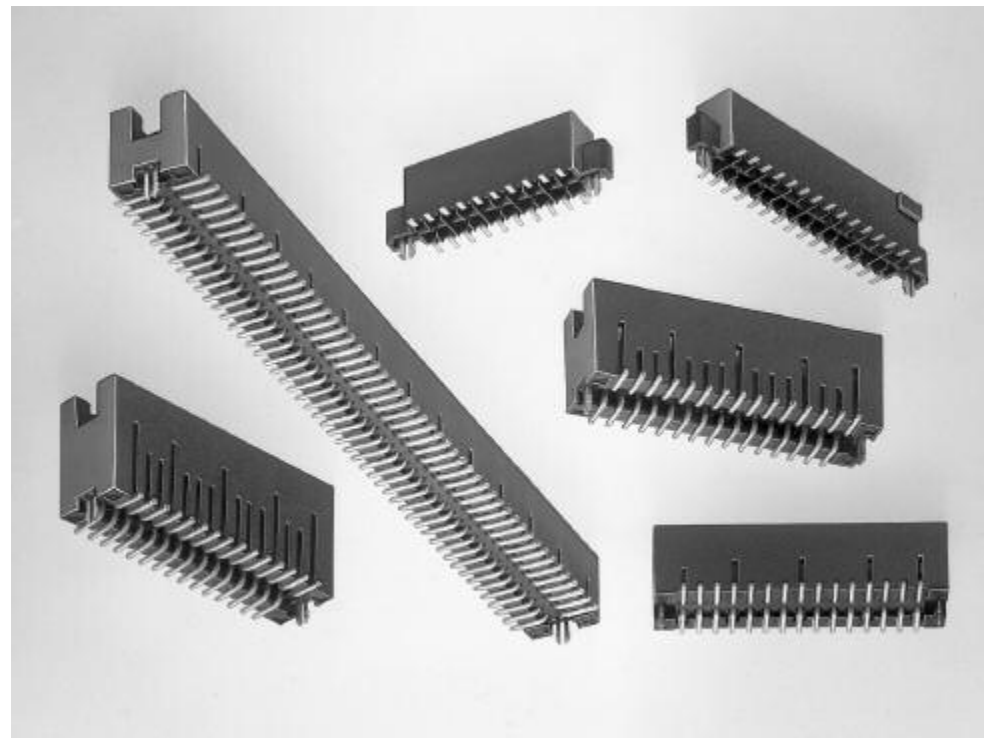

AMPMODU 50/50 Grid Vertical Headers and Receptacles are designed for parallel board-to-board stacking in high density applications.

Right-angle board-to-board and cable-to-board applications are also possible, since the vertical receptacles also mate with non-latching right-angle headers (page 24) and the vertical headers also mate with non-latching cable connectors.

Available are double row, vertical shrouded headers and receptacles in sizes ranging from 10 through 100 positions (in 10 position increments).

Parallel board-to-board stack heights of .250 [6.35], .320 [8.13] and .390 [9.91] are achievable by selection of the appropriate header. The receptacle is the same for all three stack height headers.

Non-protrusive metallic holddowns are designed for use in .062 [1.57] or thicker

PC boards and allow surface mounting to both sides of the board. In addition to providing retention during processing, the holddowns are soldered during reflow and therefore provide long-term strain relief for the solder joints.

AMPMODU 50/50 Grid Vertical Headers and Receptacles are designed to be compatible with standard surface-mount processes; IR (infrared) and VPR (vapor phase reflow). The surface-mount connectors have been designed so that dimensioning, tolerances, referenced datums,

holddown characteristics and packaging methods result in a system that is compatible with robotic assembly.

The headers and receptacles feature polarization to prevent misalignment.

### Three Board Stack Heights

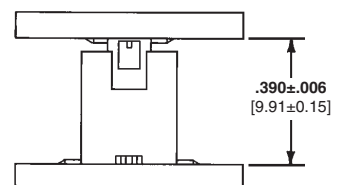
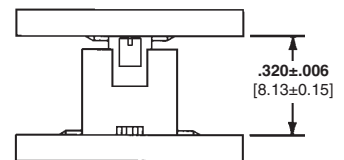
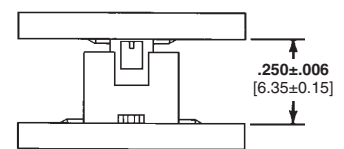

### Non-Protrusive Metallic Holddowns

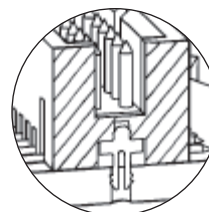

## Board-to-Board Vertical Receptacles, Double Row, .050 x .050 [1.27 x 1.27] Centerline



### Material and Finish

**Housing**—Glass-filled thermoplastic, black, 94V-0 rated

**Contacts**—Copper alloy; duplex plated .000030 [0.00076] gold in mating area, .000150 [0.00381] tin on solder tail, with entire contact underplated .000050 [0.00127] nickel

**Holddown**—Copper alloy; plated .000150 [0.00381] tin over .000050 [0.00127] nickel

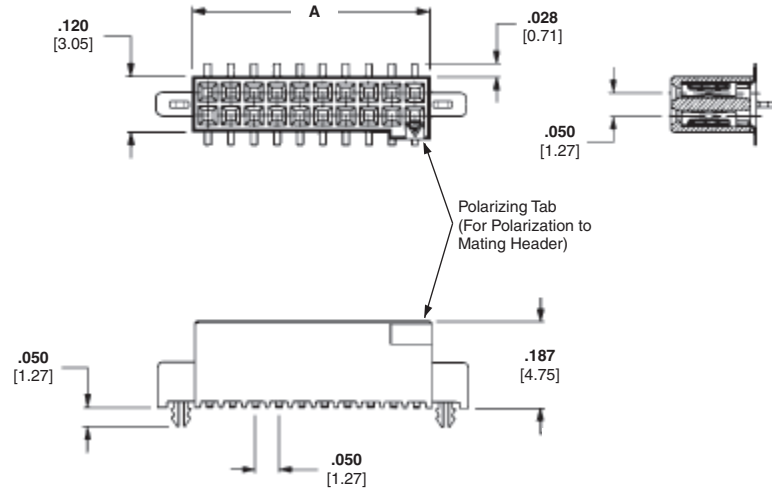

### Related Product Data

**Mating Headers** — pages 21 and 24

**PC Board Layouts** — page 22

**Performance Specifications** — page 29

**Technical Documents** — page 29

**Product Specification** 108-1332

**Application Specification** 114-7010

**Packaging** — Tube or Tape and Reel

No. of Pos.	Dimension A	Receptacle Part Numbers		
		Tube	Tape and Reel*	No Hold Down w/Vacuum Cover
10	.266 [6.75]	5-104652-1	5-147384-1	5-147413-1
20	.516 [13.11]	5-104652-2	5-147384-2	5-147413-3
30	.766 [19.46]	5-104652-3	5-147384-3	5-147413-4
40	1.016 [25.81]	5-104652-4	5-147384-4	—
50	1.266 [32.16]	5-104652-5	5-147384-5	5-147413-2
60	1.516 [38.51]	5-104652-6	5-147384-6	—
70	1.766 [44.86]	5-104652-7	5-147384-7	—
80	2.016 [51.21]	5-104652-8	5-147384-8	—
100	2.516 [63.91]	6-104652-0	5-147384-9	—

\* Parts packaged in tape and reel have vacuum pick and place cover. See PC Board Layout on page 22.

**Note:** All part numbers are RoHS compliant.

## Board-to-Board Vertical Headers, Double Row, .050 x .050 [1.27 x 1.27] Centerline



For .250 [6.35] Mated Height



For .320 [8.13] Mated Height



For .390 [9.91] Mated Height

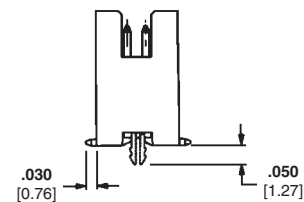
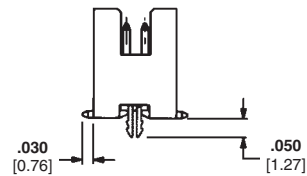
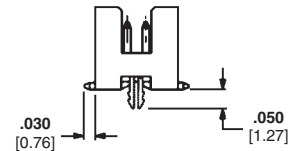
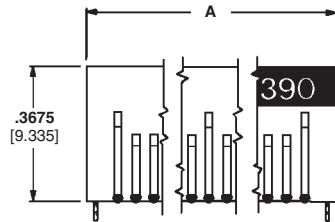
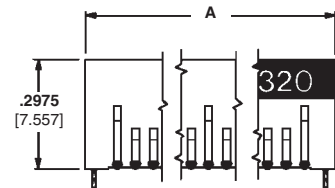
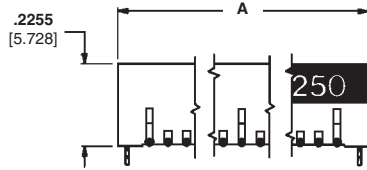
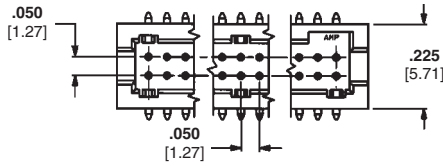

### Material and Finish

**Housing**—Glass-filled thermoplastic, black, 94V-0 rated

**Contacts**—Copper alloy; duplex plated .000030 [0.00076] gold in mating area, .000150 [0.00381] tin on solder tail, with entire contact underplated .000050 [0.00127] nickel

**Holddown**—Copper alloy; plated .000150 [0.00381] tin over .000050 [0.00127] nickel

### Related Product Data

**Mating Receptacles** — pages 20 and 26 (without latch only)

**PC Board Layouts** — page 22

**Performance Specifications** — page 29

### Technical Documents — page 29

**Product Specification** 108-1332

**Application Specification** 114-7010

**Packaging** — Tube or Tape and Reel

No. of Pos.	Dimension A	Header Part Numbers								
		.250 [6.35] Mated Height			.320 [8.13] Mated Height		.390 [9.91] Mated Height			
		Tubes	Tape & Reel*		Tubes	Tape & Reel*	Tubes		Tape & Reel*	
		Hold Down	No Hold Down			Hold Down	No Hold Down			
10	.372 [9.44]	5-104655-1	5-147381-1	5-147121-1	5-104656-1	5-147382-1	5-104693-1	—	5-147383-1	
20	.622 [15.79]	5-104655-3	5-147381-2	5-147121-2	5-104656-2	5-147382-2	5-104693-2	—	5-147383-2	
30	.872 [22.14]	5-104655-4	5-147381-3	—	5-104656-3	5-147382-3	5-104693-3	—	5-147383-3	
40	1.122 [28.49]	5-104655-5	5-147381-4	—	5-104656-4	5-147382-4	5-104693-4	—	5-147383-4	
50	1.372 [34.84]	5-104655-6	5-147381-5	—	5-104656-5	5-147382-5	5-104693-5	—	5-147383-5	
60	1.622 [41.19]	5-104655-7	5-147381-6	—	5-104656-6	5-147382-6	5-104693-6	—	5-147383-6	
70	1.872 [47.54]	5-104655-8	5-147381-7	—	5-104656-7	5-147382-7	5-104693-7	—	5-147383-7	
80	2.122 [53.89]	5-104655-9	5-147381-8	—	5-104656-8	5-147382-8	5-104693-8	—	5-147383-8	
90	2.372 [60.24]	—	—	—	5-104656-9	—	5-104693-9	—	—	
100	2.622 [66.59]	6-104655-1	5-147381-9	—	6-104656-0	5-147382-9	6-104693-0	5-147503-1	5-147383-9	

\*Parts packaged in tape and reel have vacuum pick and place cover. See PC Board Layout on page 22.

**Note:** All part numbers are RoHS compliant.

## Recommended PC Board Layouts for Vertical Connectors

### Headers

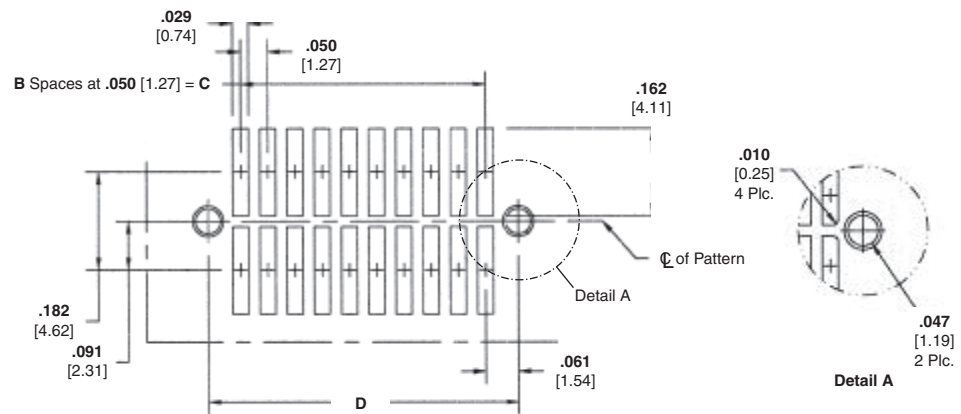

### Receptacles

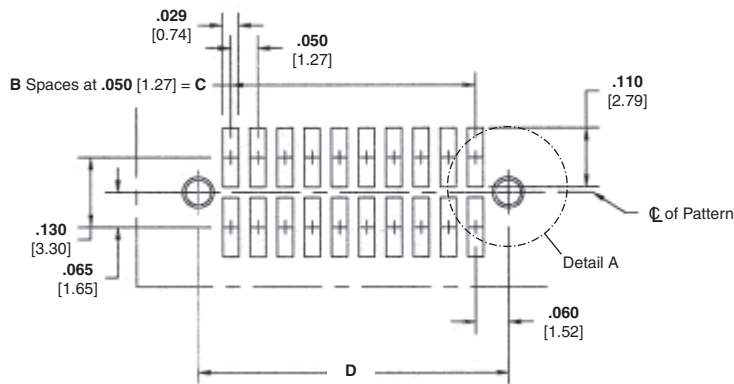

No. of Pos.	Receptacle Dimensions			Header Dimensions		
	B	C	D	B	C	D
10	4	.200 [5.08]	.320 [8.12]	4	.200 [5.08]	.322 [8.17]
20	9	.450 [11.43]	.570 [14.48]	9	.450 [11.43]	.572 [14.52]
30	14	.700 [17.78]	.820 [20.83]	14	.700 [17.78]	.822 [20.87]
40	19	.950 [24.13]	1.070 [27.19]	19	.950 [24.13]	1.072 [27.22]
50	24	1.200 [30.48]	1.320 [33.53]	24	1.200 [30.48]	1.322 [33.57]
60	29	1.450 [36.83]	1.570 [39.88]	29	1.450 [36.83]	1.572 [39.92]
70	34	1.700 [43.18]	1.820 [46.23]	34	1.700 [43.18]	1.822 [46.27]
80	39	1.950 [49.53]	2.070 [52.58]	39	1.950 [49.53]	2.072 [52.62]
90	44	2.200 [55.88]	2.320 [58.93]	44	2.200 [55.88]	2.322 [58.97]
100	49	2.450 [62.23]	2.570 [65.28]	49	2.450 [62.23]	2.572 [65.32]

**Note:** Refer to TE Customer Drawings for additional PC board layout information and dimensional tolerances.

## Board-to-Board Right-Angle Headers

### Product Facts

- Surface-mount products for right-angle board-to-board and cable-to-board applications
- Double-row, right-angle shrouded headers
- High density .050 x .050 [1.27 x 1.27] centerline grid
- Latching and non-latching versions available
- Non-protrusive metallic holddowns
- Metallic tabs, when soldered to PC board pad, provide added mechanical support
- Duplex plated post contacts; gold plated on mating area, tin plated on tails
- Compatible with standard surface-mount processing (VPR and IR)
- Standoffs on header housings allow for drainage of processing fluids
- All headers are polarized
- Sizes of 10, 20, 30, 40, 50, 60, 70, 80 and 100 positions
- Recognized under the Component Program of Underwriters Laboratories Inc., File No. E28476
- Certified by Canadian Standards Association File No. LR7189



AMPMODU 50/50 Grid Right-Angle Headers will accommodate a variety of high density packaging applications; right-angle board-to-board applications when mated with vertical receptacles (page 20) and right-angle cable-to-board applications when mated with cable connectors (page 26). The small .050 x .050 [1.27 x 1.27] centerline contact spacing allows efficient use of the PC board area.

Mechanical support of the headers to the PC board is provided by non-protrusive metallic holddowns designed for .062 [1.57] or thicker PC boards. These holddowns are of the same

design as those used in the vertical headers (page 21) and receptacles (page 20). There are also metallic tabs that are soldered to the surfaces of the PC board pads for added support.

AMPMODU 50/50 Grid Right-Angle Headers are available in double-row, in either latching or non-latching versions, and in sizes ranging from 10 through 100 positions (in 10 position increments). The latching version provides positive retention when mated with the latching cable connector (page 26). All headers feature polarization to help prevent misalignment during mating.



## Board-to-Board Right-Angle Headers, Double Row, .050 x .050 [1.27 x 1.27] Centerline

### Non-Latching Header

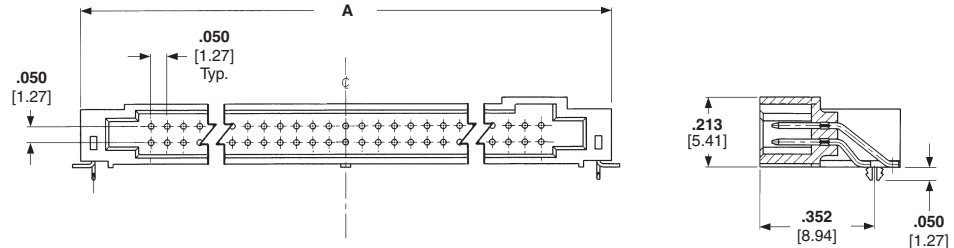
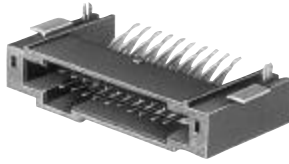

### Latching Header

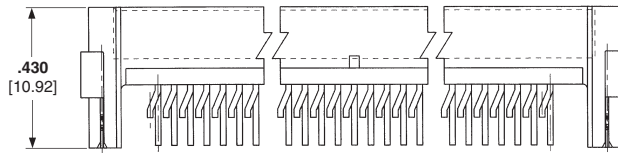
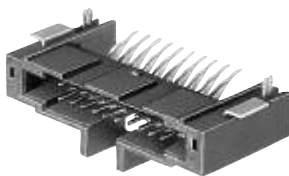

### Material and Finish

**Housing** — Liquid crystal polymer, black, 94V-0 rated

**Contacts** — Copper alloy; duplex plated .000030 [0.00076] gold in mating area, .000150 [0.000381] tin on solder tail, with entire contact under-plated .000050 [0.00127] nickel

**Holddown** — Copper alloy; plated .0000150 [0.00381] tin over .000050 [0.00127] nickel

### Related Product Data

**Mating Receptacles** — pages 20 and 26

**Performance Specifications** — page 29

**Technical Documents** — page 29

**Product Specification** 108-1443

**Application Specification** 114-7010

**Packaging** — Tube

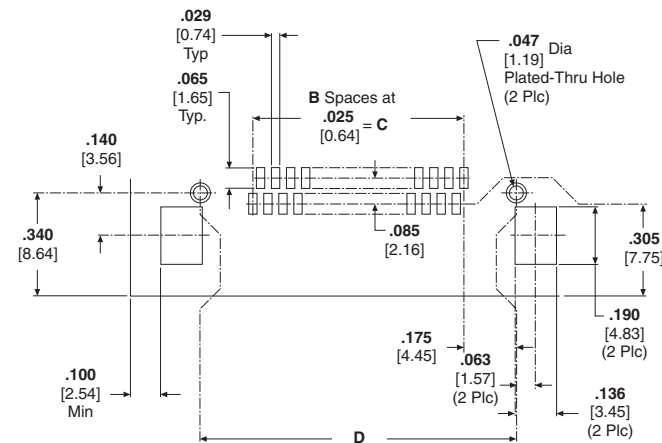

Recommended PC Board Layout



**Note:** Refer to TE Customer Drawings for additional PC board layout information and dimensional tolerances.

No. of Pos.	Dimensions				Header Part Numbers	
	A	B	C	D	Latching	Non-Latching
10	.630 [16.00]	9	.225 [5.72]	.550 [13.97]	5-104895-1	5-104894-1
20	.880 [22.35]	19	.475 [12.07]	.800 [20.32]	5-104895-2	5-104894-2
30	1.130 [28.70]	29	.725 [18.42]	1.050 [26.67]	5-104895-3	5-104894-3
40	1.380 [35.05]	39	.975 [24.77]	1.300 [33.02]	5-104895-4	5-104894-4
50	1.630 [41.40]	49	1.225 [31.12]	1.550 [39.37]	5-104895-5	5-104894-5
60	1.880 [47.75]	59	1.475 [37.47]	1.800 [45.72]	5-104895-6	5-104894-6
70	2.130 [54.10]	69	1.725 [43.82]	2.050 [52.07]	5-104895-7	5-104894-7
80	2.380 [60.45]	79	1.975 [50.17]	2.300 [58.42]	5-104895-8	5-104894-8
100	2.880 [73.15]	99	2.475 [62.87]	2.800 [71.12]	6-104895-0	6-104894-0

**Note:** All part numbers are RoHS compliant.

## Cable-to-Board Connectors

### Product Facts

- Double-row receptacle connectors provide cable-to-board connection capabilities for vertical headers (non-latching) and right-angle headers (latching and non-latching)
- IDC (Insulation Displacement Crimp) mass termination of solid or stranded round conductor .050 [1.27] centerline ribbon cable with PVC or polyethylene insulation
- Accommodates ribbon cable conductor sizes of 28 AWG [0.08-0.09 mm<sup>2</sup>] and 30 AWG [0.05 mm<sup>2</sup>] and insulation diameters up to .036 [0.91] maximum
- Reliable single beam receptacle contact design
- Duplex plated receptacle contacts; gold plated in mating area, tin in termination area
- Terminating covers (sold separately) provide both strain relief and protection to the termination area
- Sizes of 10, 20, 30, 40, 50, 60, 70, 80 and 100 positions
- Connectors available with or without metal latch
- Connectors without latches are polarized to help prevent mismatching
- Recognized under the Component Program of Underwriters Laboratories Inc.,  File No. E28476
- Certified by Canadian Standards Association  File No. LR7189

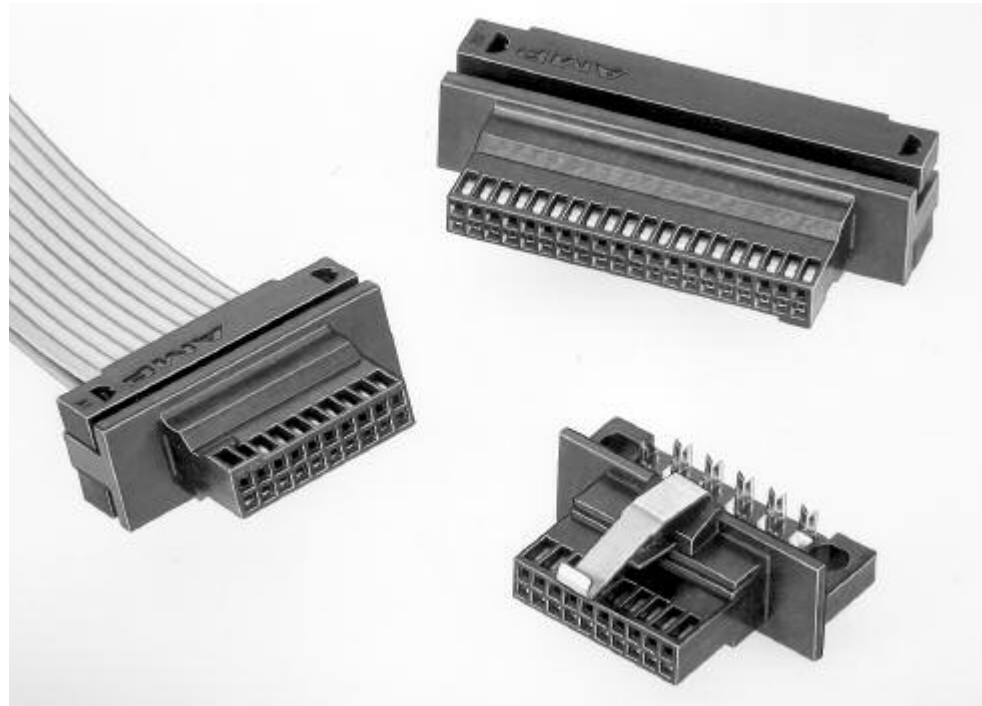

These double-row cable connectors, with a .050 x .050 [1.27 x 1.27] centerline contact spacing, provide cable-to-board connection capabilities for the AMPMODU 50/50 Grid Connector System. Cable connectors without a latch will mate with the vertical headers (page 21), while cable connectors with or without a latch can be used to mate with the right-angle headers (page 24).

The cable connectors feature reliable single-beam IDC (insulation displacement crimp) contacts which are duplex plated with .000030 [0.00076] gold. These contacts can be mass terminated to either solid or

stranded round conductor ribbon cable with conductor sizes of 28 AWG [0.08-0.09 mm<sup>2</sup>] and 30 AWG [0.05 mm<sup>2</sup>] and a maximum insulation diameter of .036 [0.91]. During termination, the terminating covers, which must be purchased separately, assist in guiding the wire into the IDC contacts, then provide strain relief when fully seated. Actual termination is accomplished with the TE manual tooling shown on page 28.

The latching version of the cable connector is equipped with a metal latch which provides positive retention of the receptacle cable connector when mated with a surface-

mounted right-angle header. The cable connector without a metal latch features polarization to help prevent mismatching. All connectors are available in sizes ranging from 10 through 100 positions (in 10 position increments).

## Cable-to-Board Receptacle Connectors, Double Row, .050 x .050 [1.27 x 1.27] Centerline

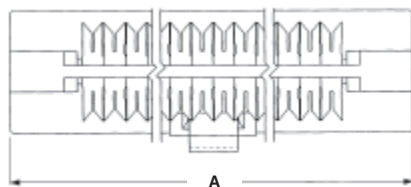
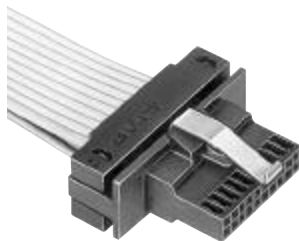

### Material and Finish

**Housing** — Thermoplastic, black, 94V-0 rated

**Latch** — Stainless steel

**Contacts** — Phosphor bronze; duplex plated .000030 [0.00076] minimum gold in mating area, .000150 [0.00381] minimum tin on solder tail, with entire contact underplated .000050 [0.00127] minimum nickel

### Related Product Data

**Mating Headers** — pages 21 and 24 (latching)

**Terminating Covers (Must be Purchased Separately, 2 Required per Connector)** — page 27

**Termination Tooling** — page 28

**Performance Specifications** — page 29

**Technical Documents** — page 29

**Product Specification** 108-1443

**Application Specification**  
408-9817, 408-9909

**Packaging** — Tube

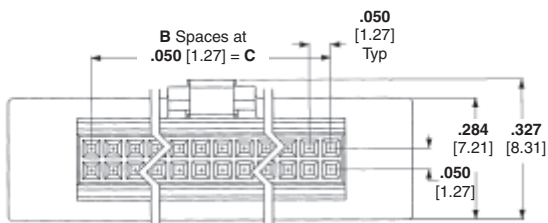
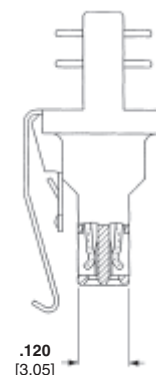
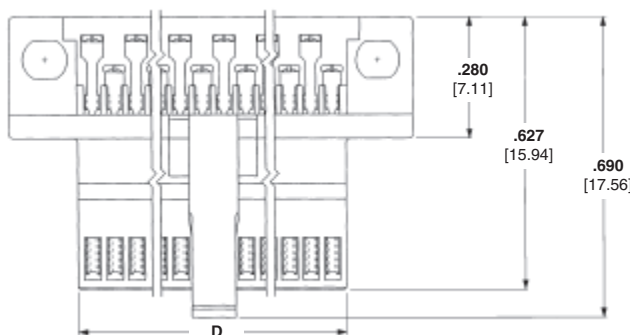

No. of Pos.	Dimensions				Receptacle Part Numbers	
	A	B	C	D	With Latch	Without Latch
10	.578 [14.68]	4	.200 [5.08]	.266 [6.76]	5-104892-1	5-104893-1
20	.828 [21.03]	9	.450 [11.43]	.516 [13.11]	5-104892-2	5-104893-2
30	1.078 [27.38]	14	.700 [17.78]	.766 [19.46]	5-104892-3	5-104893-3
40	1.328 [33.73]	19	.950 [24.13]	1.016 [25.81]	5-104892-4	5-104893-4
50	1.578 [40.08]	24	1.200 [30.48]	1.266 [32.16]	5-104892-5	5-104893-5
60	1.828 [46.43]	29	1.450 [36.83]	1.516 [38.51]	5-104892-6	5-104893-6
70	2.078 [52.78]	34	1.700 [43.18]	1.766 [44.86]	5-104892-7	5-104893-7
80	2.328 [59.13]	39	1.950 [49.53]	2.016 [51.21]	5-104892-8	5-104893-8
100	2.828 [71.83]	49	2.450 [62.23]	2.516 [63.91]	6-104892-0	6-104893-0

**Note:** All part numbers are RoHS compliant.

## Terminating Covers for Cable Connectors



### Material

Glass-filled thermoplastic,  
black, 94V-0 rated

### Related Product Data

**Connectors used with Covers** —  
page 26

**Termination Tooling** — page 28

**Technical Documents** — page 29

**Product Specification** 108-1443

**Application Specification**  
408-9817, 408-9909

**Packaging** — Plastic bag

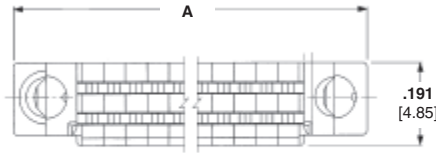

No. of Pos.	Dimension A	Terminator Cover Part Numbers
10	.565 [14.35]	104891-1
20	.815 [20.70]	104891-2
30	1.065 [27.05]	104891-3
40	1.315 [33.82]	104891-4
50	1.565 [39.75]	104891-5
60	1.815 [46.10]	104891-6
70	2.065 [52.45]	104891-7
80	2.315 [58.80]	104891-8
100	2.815 [71.50]	1-104891-0

**Note:** Terminating covers must be purchased separately, two are required for each cable connector.

**Note:** All part numbers are RoHS compliant.

## Application Tooling for Cable Connectors

The Manual Miniature Application Frame Assembly 91295-1, equipped with a Cover Closing Kit 543518-1, is used for the IDC termination of ribbon cable to the cable connectors shown on page 26.

Prior to termination, the covers must be partially assembled onto a connector housing, the cable inserted between the covers and contacts and the covers preclosed by hand, clamping the cable in place.

In the Manual Miniature Application Frame Assembly, the covers are fully seated to complete the mass termination and provide strain relief for the completed connection.

For tooling information, call Technical Support Center **1-800-522-6752**.



Manual Miniature Application Frame Assembly 91295-1 with Cover Closing Kit 543518-1

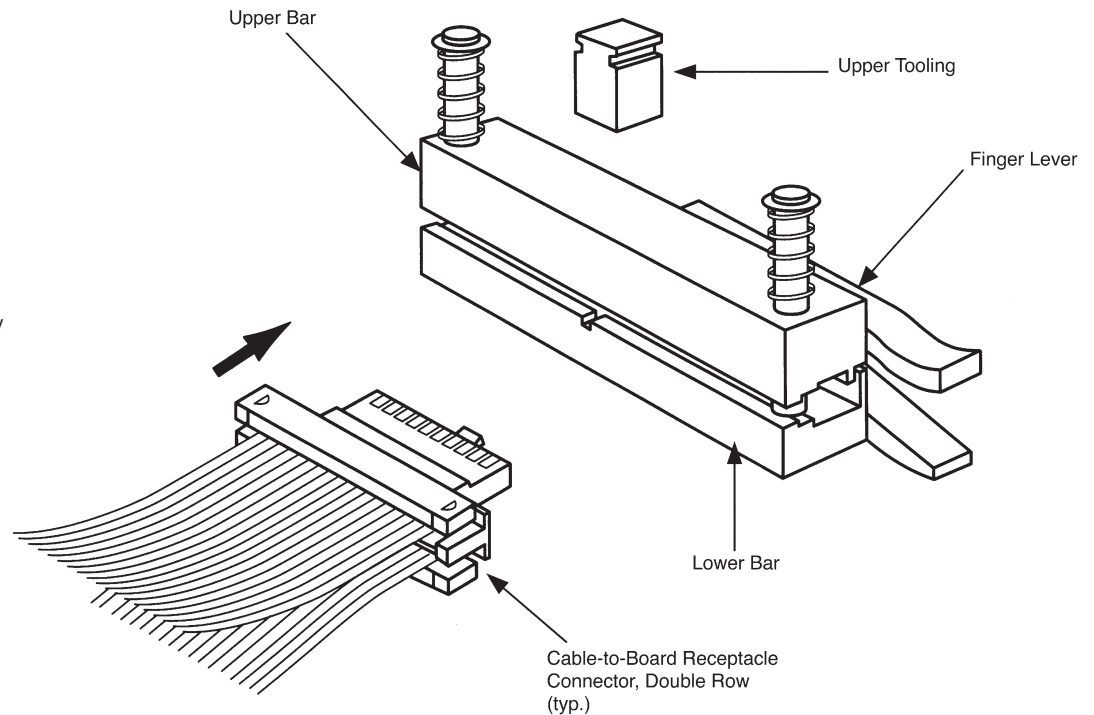

**Note:** Refer to TE Instruction Sheets 408-9817 (Frame Assembly 91295-1) and 408-9909 (Cover Closing Kit 543518-1) for complete termination/tooling information.

**Note:** All part numbers are RoHS compliant.

---

## Performance Specifications

---

### Board-to-Board Connectors, Vertical and Right-Angle

**Mating Force** — 6.4 oz (1.78 N) max. per contact  
**Unmating Force** — 1.0 oz [0.28 N] min. per contact  
**Durability** — Tested to 200 cycles min.  
**Current Rating** — (30°C T rise): .5 ampere per contact  
**Operating Temperature Range** — -65°C to +105°C  
**Termination Resistance** — 16 milliohms max. (initial)  
**Insulation Resistance** — 5000 megohms min. (initial)  
**Dielectric Withstanding Voltage** — 300 VAC

### Cable-to-Board Connectors

**Mating Force** — 6.4 oz (1.78 N) max. per contact  
**Unmating Force Without Latch** — .5 oz [0.14 N] min. per contact  
**Durability** — Tested to 200 cycles min.  
**Current Rating** — (10°C T rise); .5 ampere per contact  
**Operating Temperature Range** — -65°C to +105°C  
**Termination Resistance** — 25 milliohms max. (initial and final)  
**Insulation Resistance** — 5000 megohms min. (initial)  
**Dielectric Withstanding Voltage** — 300 VAC

---

## Technical Documents

---

Various technical documents are available for your use:

**Product Specifications** describe technical performance characteristics and verification tests. They are intended for the Design, Component and Quality Engineer.

108-1332          AMPMODU 50/50 Grid Vertical Board-to-Board Connectors  
108-1443          AMPMODU 50/50 Grid Right-Angle Board-to-Board and Cable Connectors

**Application Specifications** describe requirements for using the product in its intended application and/or crimping information. They are intended for the Packaging and Design Engineer and the Machine Setup Person.

114-7010          AMPMODU 50/50 Grid Connector System

**Instruction Sheets** provide instructions for assembling or applying the product. They are intended for the Manufacturing Assembler or Operator.

408-9817          Manual Miniature Application Frame Assembly 91295-1  
408-9909          Cover Closing Kit 543518-1

**Note:** All part numbers are RoHS compliant.



## Micro-MaTch Miniature Connector System

### Features/ Benefits

- Available in 2 to 20 positions
- Applicable Wire: 20~28 AWG
- Wire connectors supplied on-tape and suitable for mass termination of 28 AWG [0.08 mm<sup>2</sup> to 0.09 mm<sup>2</sup>] ribbon cable
- Tin plated contact design
- Guaranteed minimum contact force of 2.0 N
- Fretting corrosion proof thanks to additional positioning spring member
- Full range of application tooling from hand tool to fully automated equipment

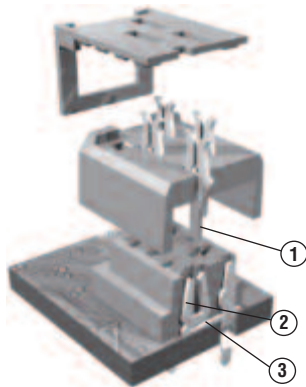
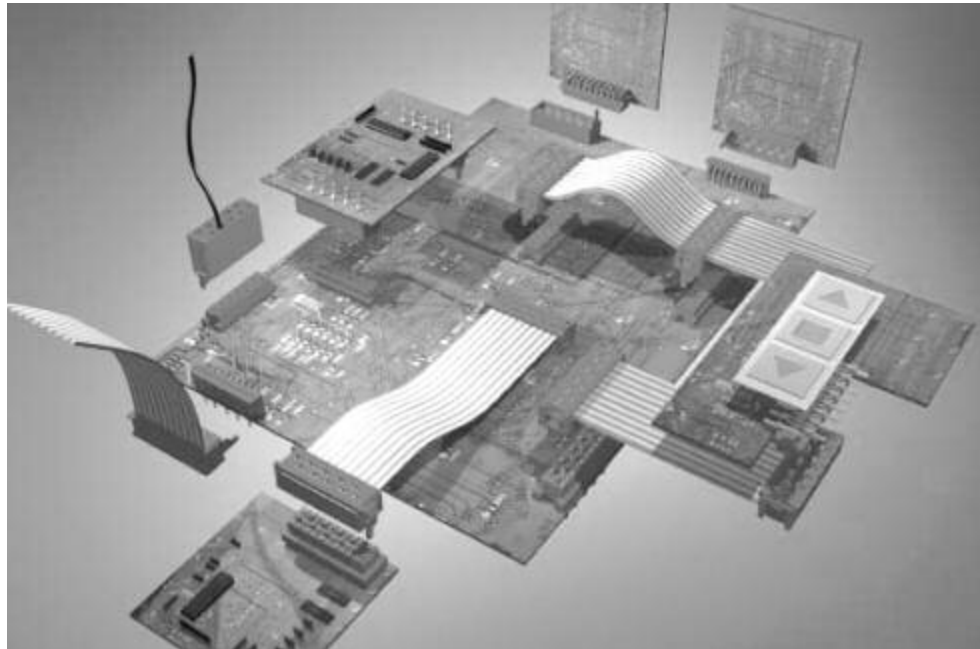

1. Contact Pin
2. Contact Spring
3. Positioning

Miniaturization and the trend towards higher density of electronic functions on a substrate led to the introduction of smaller interconnection systems. The Micro-MaTch connector family, with its contact spacing of 1.27 mm, fully complies with the electronic packaging requirements of today and the future. The system offers a range of board and wire connectors, enabling a variety of wire-to-board and board-to-board interconnections. The Micro-MaTch contact concept shown on this page is essentially different from other systems available.

By its design the traditional failure mode in tin plated connections, fretting corrosion, is prevented. Due to an additional positioning spring in the female part,

relative movements caused by vibrations/thermal expansion between male and female contacts are absorbed. By preventing movements on the contact spot, a gas tight connection can be guaranteed under all circumstances.

The contact spring is located in the board connector and not in the cable connector, which is usually the case. The counter part, incorporated in the cable connector, is a simple pin, either with an insulation displacement section, suitable for the mass-termination of cable or with a kinked solder leg to be soldered onto a PC Board. The separation of these two basic functions of the contact system — contact force generation and wire termination — enables the independent

optimization of both functions and also leads to relatively simple contact shapes.

Because of their shapes contacts can be post-plated, leaving no bare edges in the contact and wire slot area. The contact spring system features an additional spring member — the positioning spring — which compensates positional tolerances. In this way the contact spring can be fully optimized for its basic function, so that the relatively high contact force, required for tin plated contact systems, can be guaranteed under all circumstances.

The Micro-MaTch contact spring system is absolutely fretting corrosion proof by its design.

## Micro-MaTch Miniature Connector System Overview Technical Data

### Technical Data

<b>Centerline:</b>	1.27 mm (staggered)
<b>Number of Positions:</b>	4, 6, 8, 10, 12, 14, 16, 18, 20, and some 24 positions
<b>Contact Material:</b>	Phosphor bronze
<b>Contact Finish:</b>	Tin over Nickel
<b>Housing Material:</b>	Thermoplastic polyester, red, glass-filled For surface mount versions polyamide 4.6
<b>Flammability rating:</b>	per UL 94 V-0
<b>UL-recognized:</b>	File E28476 Vol. 23 Section 4
<b>Contact Resistance:</b>	10 MΩ max.
<b>Insulation Resistance:</b>	1.000 MΩ min.
<b>Nominal Voltage:</b>	230 V
<b>Current Rating:</b>	1.5 A max.
<b>Temperature Range:</b>	-40° C to +105° C (operating)
<b>Mating Force:</b>	5N max. per contact
<b>Unmating Force:</b>	1N min. per contact
<b>Minimum Contact Force:</b>	2N min.
<b>Product Specification:</b>	108-19052
<b>Application Specification:</b>	114-19016, 114-19051
<b>RoHS Compliance Code:</b>	Always RoHS compliant (directive 2002/95/EC) for all types
<b>Lead-free Process Capable:</b>	Wave solder capable to 265° C for through hole versions reflow solder capable to 260° C for SMD versions

### PC Board Connectors

<b>PC Board Thickness:</b>	1.6 mm nominal
<b>PC Board Hole Diameter:</b>	0.8 mm for solder connectors

### Ribbon Connectors

<b>Cable Type:</b>	Ribbon cable, UL Style 2651
<b>Conductor Spacing:</b>	1.27 mm (.050")
<b>Conductor Diameter:</b>	Solid 0.30 mm diameter Stranded 0.08 mm <sup>2</sup> 7 x 0.12 - 0.13 mm (other diameters and/or configurations on request)
<b>Insulation Type:</b>	semi-rigid PVC
<b>Insulation Diameter:</b>	0.9 ± 0.1 mm

### Discrete Wire (COSI) Connectors

<b>Cable Type :</b>	AWG 28-24 and 24-20
---------------------	---------------------

### Micro-MaTch Miniature Connector System Applications (3 Dimensions)

<b>Male Connectors</b> 	<b>Male-on-Wire</b> Part Number 215083	<b>Male-on-Board</b> Part Number 215464	<b>COSI</b> Part Number 338095 Part Number 338096 Part Number 338097	<b>Paddle Board</b> Part Number 215570
<b>Female Connectors</b> 	<b>1</b> 	<b>2</b> 	<b>3</b> 	
<b>Female Top Entry</b> Part Number 215079	<b>4</b> 	<b>5/6</b> 	<b>7</b> 	
<b>Female Side Entry</b> Part Number 215460	<b>8</b> 	<b>9</b> 	<b>10</b> 	
<b>SMD Top Entry</b> Part Number 188275				

Image	Description (see also page 33)
1	Wire-to-Board through hole
2	Board-to-Board through hole
3	Wire-to-Board (discrete wire), through hole
4	Wire-to-Board right angle, through hole
5	Board-to-Board right angle, through hole
6	Board-to-Board right angle, through hole
7	Wire-to-Board right angle (discrete wire), through hole
8	Wire-to-Board surface mount
9	Board-to-Board surface mount, through hole
10	Wire-to-Board (discrete wire), surface mount

## Micro-MaTch Miniature Connector System Applications (2 Dimensions)

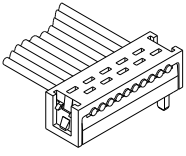
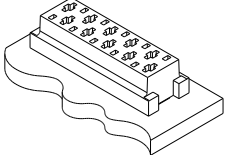
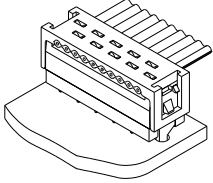
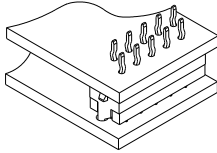
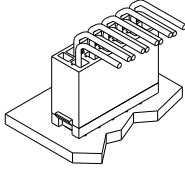
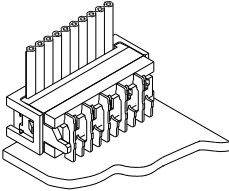
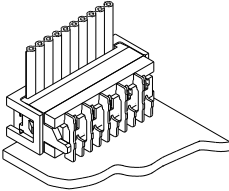
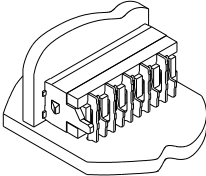
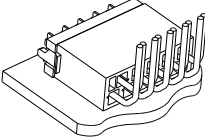
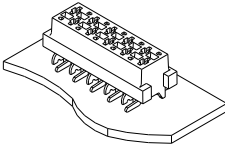
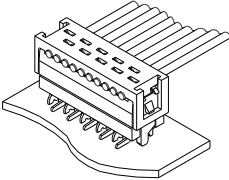
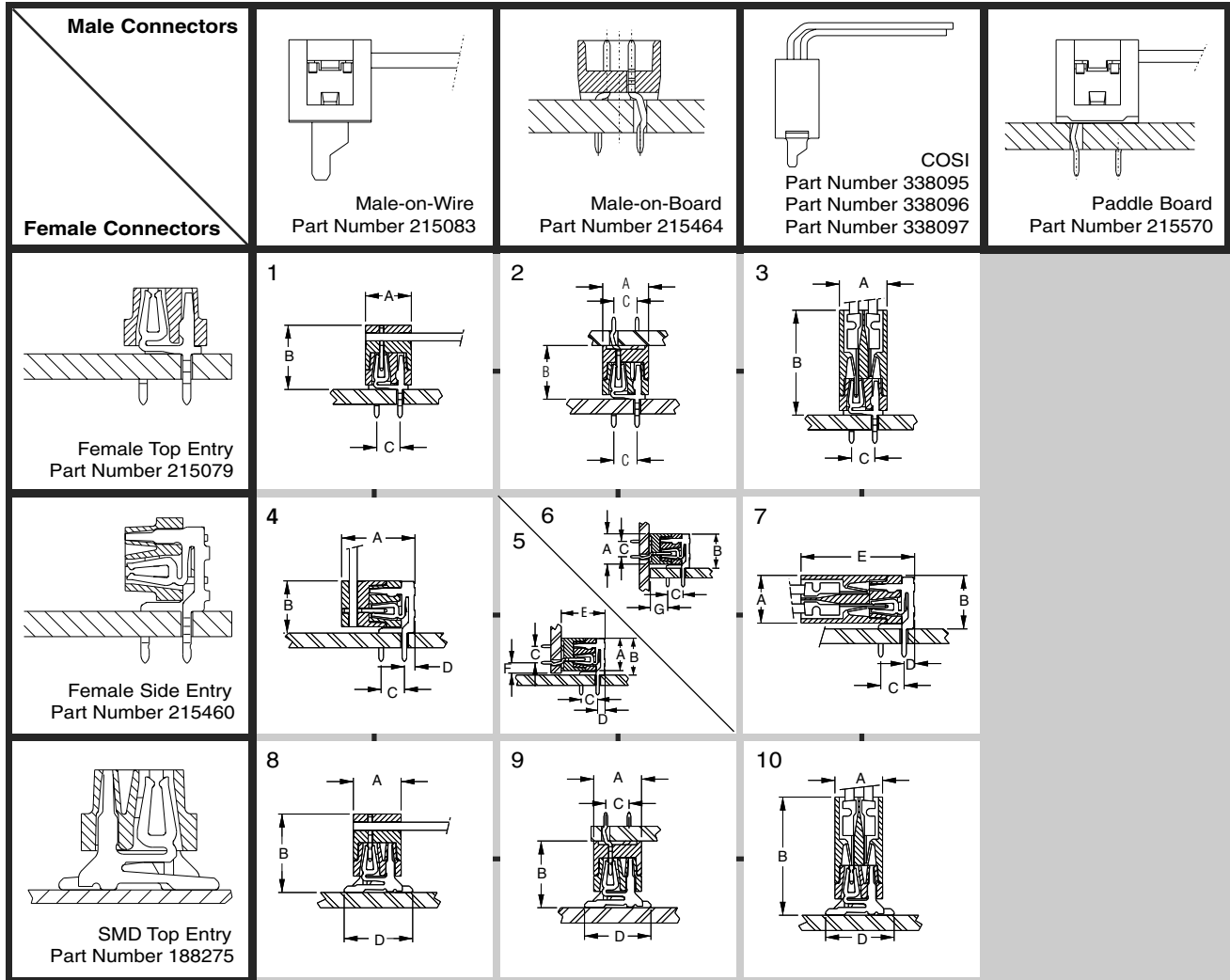

Micro-MaTch Miniature Connector System Applications (2 Dimensions)

Image	Dimensions (mm)						
	A (max)	B (max)	C	D (max)	E (max)	F(max)	G (max)
1	5.2	7.5	2.54	—	—	—	—
2	5.2	6.2	2.54	—	—	—	—
3	5.2	9.7	2.54	—	—	—	—
4	8.4	5.9	2.54	1.5	—	—	—
5	5.2	5.9	2.54	1.5	7.0	1.6	—
6	5.2	5.9	2.54	1.5	—	—	2.8
7	5.2	5.9	2.54	1.5	10.6	—	—
8	5.2	8.5	—	7.1	—	—	—
9	5.2	7.1	2.54	7.1	—	—	—
10	5.2	10.7	—	7.1	—	—	—

## Micro-MaTch Miniature Connector System — Female-on-Board Connector, Top Entry

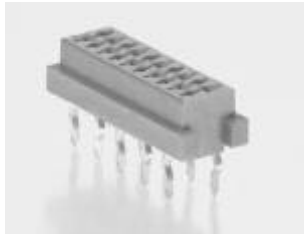

This connector version incorporates the patented Micro-MaTch contact spring system and is designed to be soldered onto PC Boards with a nominal thickness of 1.6 mm.

The solder legs are indented, providing firm retention of the connector before and during the soldering operations.

As polarization is accomplished directly between the Micro-MaTch male connectors and the PC Board, this top entry female connector does not have any polarizing features. Therefore, the orientation of the connector on the PC Board is irrelevant.

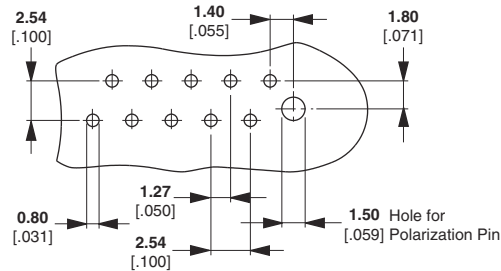
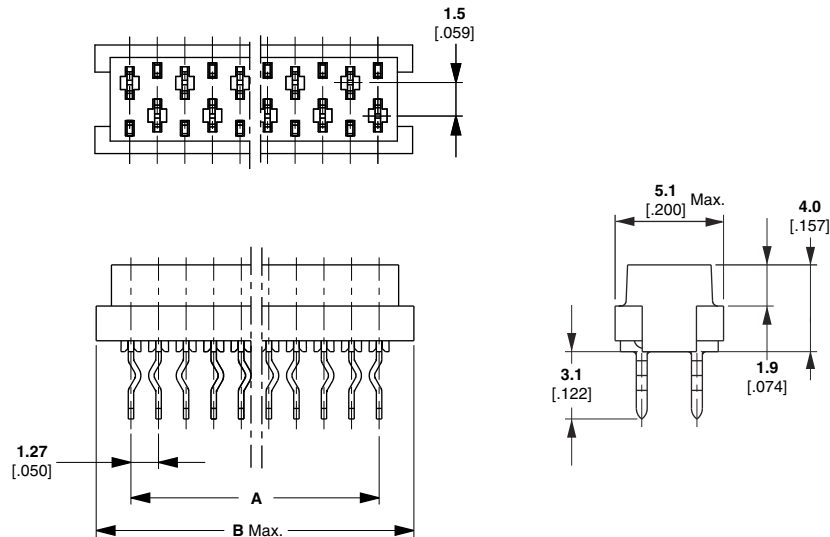

**Typical Hole Pattern  
Not Solder Side Shown**

**Notes:**

1. Connectors are always sideways mounted onto an adhesive tape.
2. Standard packaging quantity is 2500 connectors on a reel with a diameter of 600 mm.
3. At additional charge a special packaging option is available: 250 connectors on a reel with a diameter of 250 mm, packed in a dedicated dispenser box.

**Mates with:**

- X-338095-X
- X-215083-X
- X-215464-X
- X-338728-X

No. of Positions	Dimensions (mm)		Part Numbers	
	A	B	2500 Connectors/Reel	250 Connectors/Box
4	3.81	7.1	215079-4	7-215079-4
6	6.35	9.7	215079-6	7-215079-6
8	8.89	12.2	215079-8	7-215079-8
10	11.43	14.7	1-215079-0	8-215079-0
12	13.97	17.3	1-215079-2	8-215079-2
14	16.51	19.8	1-215079-4	8-215079-4
16	19.05	22.4	1-215079-6	8-215079-6
18	21.59	24.9	1-215079-8	8-215079-8
20	24.13	27.4	2-215079-0	9-215079-0

## Micro-MaTch Miniature Connector System — Female-on-Board Connector, Side Entry



This connector version is identical to the top entry version with two exceptions:

- The solder legs are parallel to the mating face of the connector instead of perpendicular.
- It's housing is polarized, so that polarization is accomplished directly between the two mating connectors. Proper orientation of the connectors on the PC Board is relevant here.

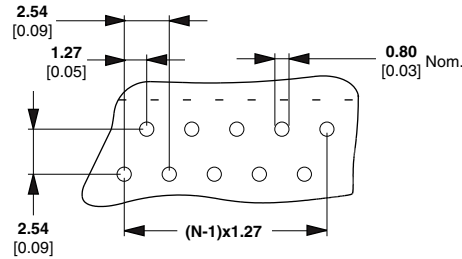
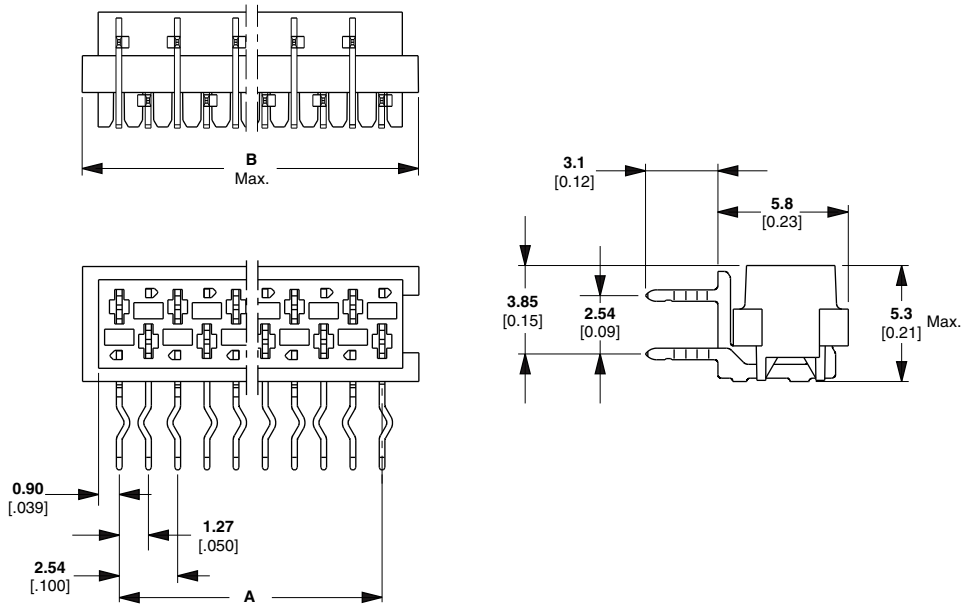

**Recommended PCB Hole Layout**  
Not Solder Side Shown

### Notes:

1. Connectors are always sideways mounted onto an adhesive tape.
2. Standard packaging quantity is 2500 connectors on a reel with a diameter of 600 mm.
3. At additional charge a special packaging option is available: 250 connectors on a reel with a diameter of 250 mm, packed in a dedicated dispenser box.

### Mates with:

- X-338095-X
- X-215083-X
- X-215464-X
- X-338728-X

No. of Positions	Dimensions (mm)		Part Numbers	
	A	B	2500 Connectors/Reel	250 Connectors/Box
4	3.81	7.1	(1500) 215460-4	7-215460-4
6	6.35	9.7	215460-6	7-215460-6
8	8.89	12.2	215460-8	7-215460-8
10	11.43	14.7	1-215460-0	8-215460-0
12	13.97	17.3	1-215460-2	8-215460-2
14	16.51	19.8	1-215460-4	8-215460-4
16	19.05	22.4	1-215460-6	8-215460-6
18	21.59	24.9	1-215460-8	8-215460-8
20	24.13	27.4	2-215460-0	9-215460-0



## Micro-MaTch Miniature Connector System — Female-on-Board Connector Surface Mount Device (SMD)



This SMD connector version is designed for standard reflow and infrared solder processes ("FULL SMD"). Polarization is accomplished by the housing, therefore no polarization holes in the PC Board are required.

The contact is designed with an additional spring to compensate for differences in thermal expansion between housing and PCB. Due to this feature, tension on solder joints is prevented.

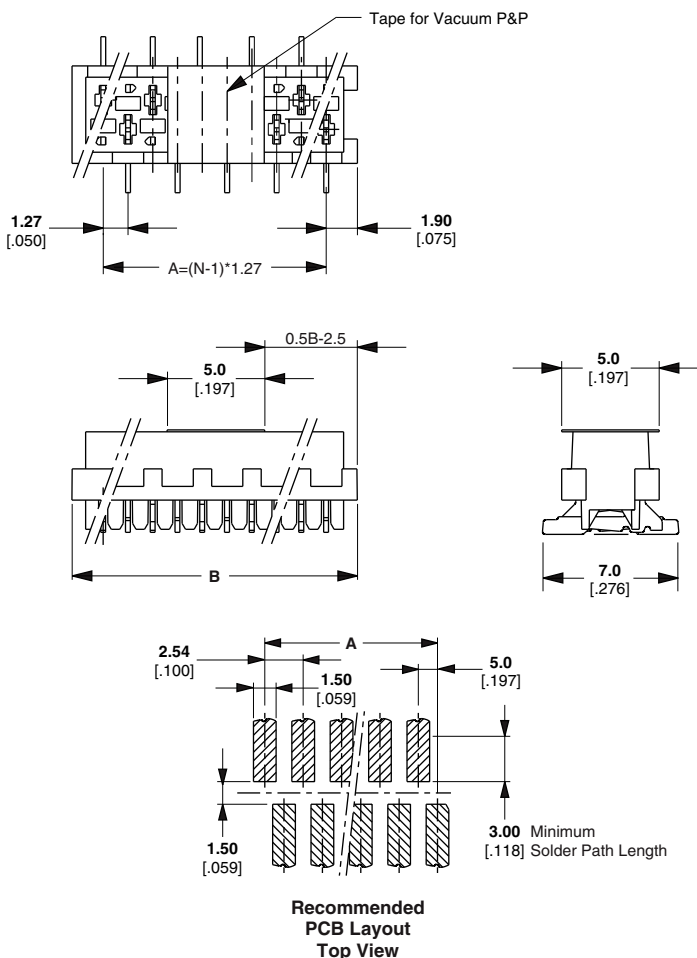

### Notes:

1. To enable automatic Pick & Placement, connectors are always packed in embossed tape according EIA481 specification.
2. Standard packaging quantity is 900 pcs on a reel with a diameter of 330 mm.
3. Connectors are supplied with or without a feature for vacuum Pick & Placement.
4. For this connector no additional solder hold down is required.

### Mates with:

- X-338095-X
- X-215083-X
- X-215464-X
- X-338728-X

No. of Positions	Dimensions (mm)		Part Numbers	
	A	B	2500 Connectors/Reel	250 Connectors/Box
4	3.81	7.1	188275-4	7-188275-4
6	6.35	9.7	188275-6	7-188275-6
8	8.89	12.2	188275-8	7-188275-8
10	11.43	14.7	1-188275-0	8-188275-0
12	13.97	17.3	1-188275-2	8-188275-2
14	16.51	19.8	1-188275-4	8-188275-4
16	19.05	22.4	1-188275-6	8-188275-6
18	21.59	24.9	1-188275-8	8-188275-8
20	24.13	27.4	2-188275-0	9-188275-0

## Micro-MaTch Miniature Connector System — Male-on-Board Connector



This male connector version is designed to be soldered onto PC Boards with a nominal thickness of 1.6 mm.

The solder legs are indented for firm retention of the connector in the PC Board.

The connector housing features a polarizing pin on one end for proper orientation of this connector version.

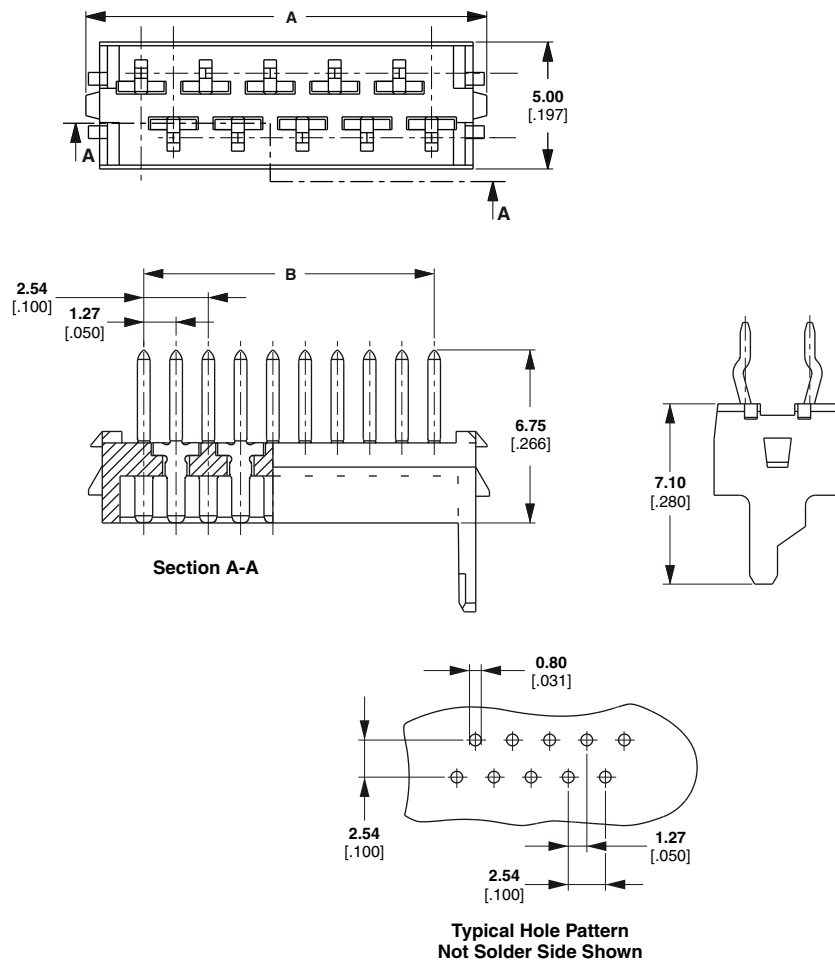

Micro-MaTch Miniature Connector System — Male-on-Board Connector

**Notes:**

1. To enable automatic Pick & Placement, connectors are always packed in embossed tape according EIA481 specification.
2. Standard packaging quantity is 900 pcs on a reel with a diameter of 330 mm.
3. Connectors are supplied with or without a feature for vacuum Pick & Placement.
4. For this connector no additional solder hold down is required.

**Mates with:**

- X-338095-X
- X-215083-X
- X-215464-X
- X-338728-X

No. of Positions	Dimensions (mm)		Part Numbers	
	A	B	2500 Connectors/Reel	250 Connectors/Box
4	3.81	8.2	215464-4	7-215464-4
6	6.35	10.7	215464-6	7-215464-6
8	8.89	13.3	215464-8	7-215464-8
10	11.43	15.8	1-215464-0	8-215464-0
12	13.97	18.3	1-215464-2	8-215464-2
14	16.51	20.8	1-215464-4	8-215464-4
16	19.05	23.4	1-215464-6	8-215464-6
18	21.59	25.9	1-215464-8	8-215464-8
20	24.13	28.4	2-215464-0	9-215464-0

## Micro-MaTch Miniature Connector System — Male-on-Wire Connector



For the wire connection, a well-known type blade with a single slot is used. The insides of the slots are tin plated for stable and reliable connections.

The connector is supplied with a pre-assembled cover, providing excellent positioning of the ribbon cable before and during the insulation displacement process.

After termination the cover is held in place by each individual contact in addition to two plastic latches at both ends of the connector.

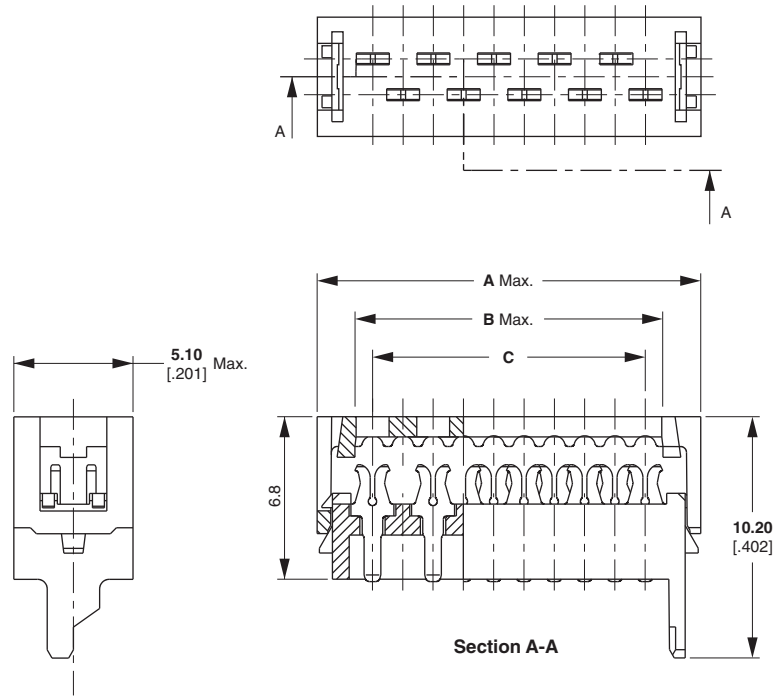

**Remark:**

The Micro-MaTch Male-on-Wire connector is specifically designed to be disengaged from its counterpart by pulling the cable in the appropriate direction.

**Notes:**

1. Connectors are always sideways mounted onto an adhesive tape.
2. Standard packaging quantity is 2500 connectors on a reel with a diameter of 600 mm.
3. At additional charge a special packaging option is available: 250 diameter of 250 mm, packed in a dedicated dispenser box.

**Mates with:**

- X-215079-X
- X-215460-X
- X-188275-X
- X-215079-X
- X-338068-X
- X-338069-X
- X-338070-X
- X-100411-X
- X-188431-X

No. of Positions	Dimensions (mm)			Part Numbers	
	A	B	C	2500 Connectors/Reel	250 Connectors/Box
4	8.6	5.4	3.81	215083-4	7-215083-4
6	11.1	8.0	6.35	215083-6	7-215083-6
8	3.6	10.5	8.89	215083-8	7-215083-8
10	16.2	13.0	11.43	1-215083-0	8-215083-0
12	18.7	15.6	13.97	1-215083-2	8-215083-2
14	21.3	18.1	16.51	1-215083-4	8-215083-4
16	23.8	20.7	19.05	1-215083-6	8-215083-6
18	26.3	23.2	21.59	1-215083-8	8-215083-8
20	28.9	25.7	24.13	2-215083-0	9-215083-0
24	34.0	30.8	29.21	2-215083-4	9-215083-4

## Micro-MaTch Miniature Connector System — Paddle Board Connector



Direct soldering of a ribbon cable onto a PC Board is a very difficult job with the smaller sizes of ribbon cable. If such a permanent cable connection is required, the application can be facilitated by using this connector type.

The Paddle Board connector is applied to the ribbon cable with the same application tooling, available for the termination of the Male-on-Wire connector.

The solder legs are indented and provide mechanical retention of the connector/cable assembly in the PC Board before and during soldering.

This Paddle Board connector version is designed to be soldered onto PC Boards with a nominal thickness of 1.6 mm.

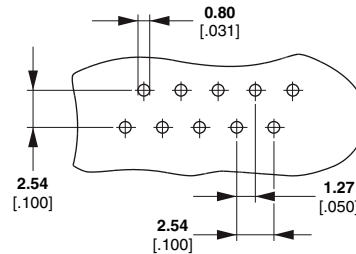
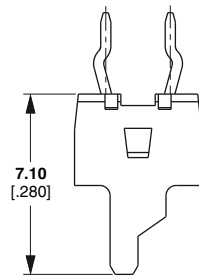
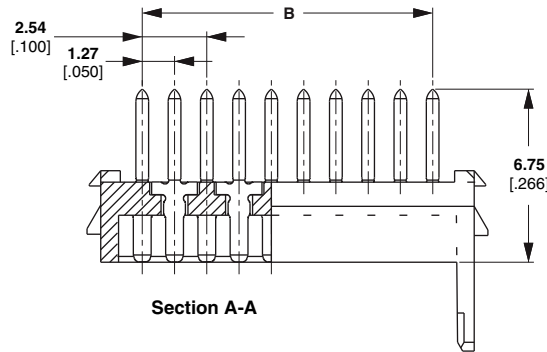
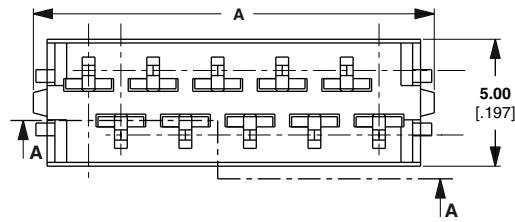

**Typical Hole Pattern**  
Not Solder Side Shown

**Notes:**

1. To enable automatic Pick & Placement, connectors are always packed in embossed tape according EIA481 specification.
2. Standard packaging quantity is 900 pcs on a reel with a diameter of 330 mm.
3. Connectors are supplied with or without a feature for vacuum Pick & Placement.
4. For this connector no additional solder hold down is required.

**No mate — direct soldering of ribbon cable onto the PC Board**

No. of Positions	Dimensions (mm)			Part Numbers	
	A	B	C	2500 Connectors/Reel	250 Connectors/Box
4	8.6	5.4	3.81	215570-4	7-215570-4
6	11.1	8.0	6.35	215570-6	7-215570-6
8	3.6	10.5	8.89	215570-8	7-215570-8
10	16.2	13.0	11.43	1-215570-0	8-215570-0
12	18.7	15.6	13.97	1-215570-2	8-215570-2
14	21.3	18.1	16.51	1-215570-4	8-215570-4
16	23.8	20.7	19.05	1-215570-6	8-215570-6
18	26.3	23.2	21.59	1-215570-8	8-215570-8
20	28.9	25.7	24.13	2-215570-0	9-215570-0
24	34.0	30.8	29.21	2-215570-4	—

## Micro-MaTch Miniature Connector System — Crimp On Snap In (COSI) Connector



### Basic Part Number 338095 and Contacts Part Numbers 338096 and 338097

This crimp version for discrete Wire-to-Board applications is fully compatible with all female connectors of the Micro-MaTch family.

Insulation and wire crimp barrel are copies of the well proven AMPLIMITE contacts. After mating with a Micro-MaTch female connector the contacts are fully protected by isolating plastics. Contacts are made of a pre-tinned phosphor bronze.

Contacts are supplied in a range for 24-20 AWG and 28-24 AWG. For repair operations an extraction tool is available; Part Number 734873-1.

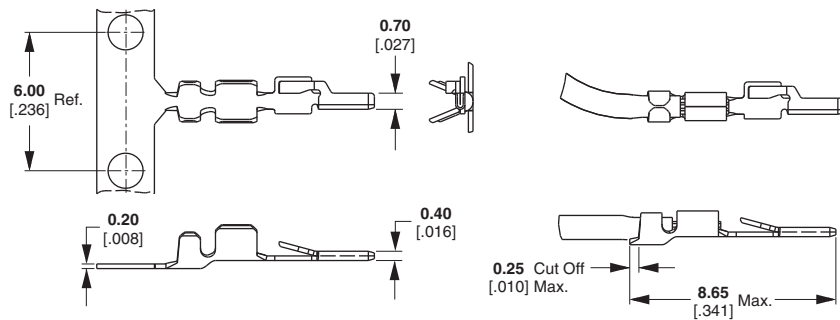
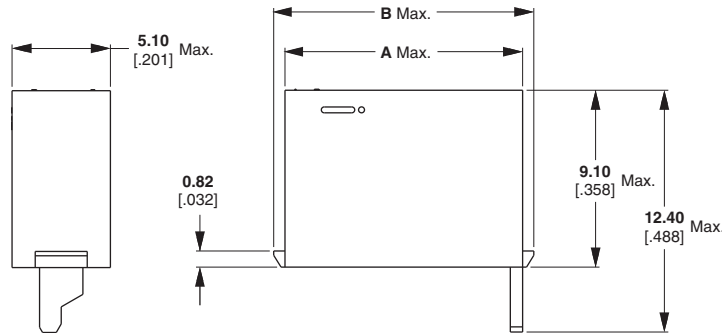
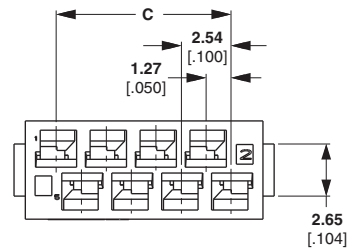

**Notes:**

1. Contacts can be crimped using a G-terminator or mini stripper crimper based applicator.
2. For the contacts on strip the standard packaging quantity is 15.000 pcs on a reel with a diameter of 600 mm.
3. For repair/service contacts are packaged 750 pcs. Per reel, to be used with handtools.
4. The housings are bulk packed in a box with a packaging quantity varying from 200 to 900 pcs per box.

Mates with:  
X-338095-X

Wire Size Range		Insulation Diameter (mm)	Part Number	
(mm <sup>2</sup> )	(AWG)		Large reel, 15.000	Small reel, 750
0.08-0.20	28-24	0.76-1.00	338096-1	1-338096-1
0.20-0.50	24-20	1.27-1.52	338097-1	1-338097-1

Mates with:  
X-215079-X  
X-215460-X  
X-188275-X  
X-215079-X  
X-338068-X  
X-338069-X  
X-338670-X  
X-100411-X  
X-188431-X

No. of Positions	Dimensions (mm)			Part Numbers	
	A	B	C	2500 Connectors/Reel	250 Connectors/Box
4	7.2	8.4	3.81	338095-4	900
6	9.8	10.9	6.35	338095-6	700
8	12.3	13.5	8.89	338095-8	500
10	14.9	16.0	11.43	1-338095-0	450
12	17.4	18.5	13.97	1-338095-2	400
14	19.9	21.1	16.51	1-338095-4	350
16	22.5	23.6	19.05	1-338095-6	300
18	25.0	26.2	21.59	1-338095-8	250
20	27.6	28.7	24.13	2-338095-0	200

## Micro-MaTch Miniature Connector System — Specials

### SMC Connector Part Number 100411

This connector type enables a solderless application to the printed circuit board. Contact is made on the surface of the PCB, enabling the use of paperphenol and epoxy boards with both drilled and punched holes. This connector is suitable for both Wire-to-Board as Board-to-Board connections. Because this connector is mounted on the solder side, the components of both PCB's in a parallel Board-to-Board application, will be in the same direction. By this, the stacking of two or more PCB's is possible. Application tooling available on request.

**Mates with:**    **X-215464-X**                      **X-215083-X**  
                          **X-338095-X**

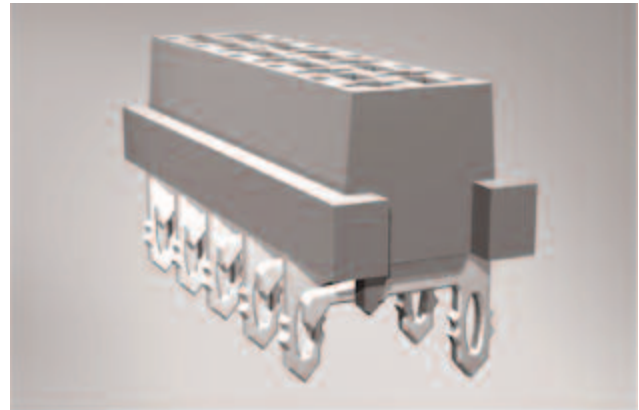

### Locking Latch Part Numbers 338068/338069/338070

For Wire-to-Board applications this feature provides an audible click during mating. This feature is available for the standard Micro-MaTch female connectors. Cross reference is made by base part number x-338068-x instead of x-215079-x, x-338069-x instead of x-188275-x and x-338070-x instead of x-215460-x (standard large reel packaging only).

**Mates with:**    **X-338095-X**                      **X-338728-X**  
                          **X-215464-X**                      **X-215083-X**

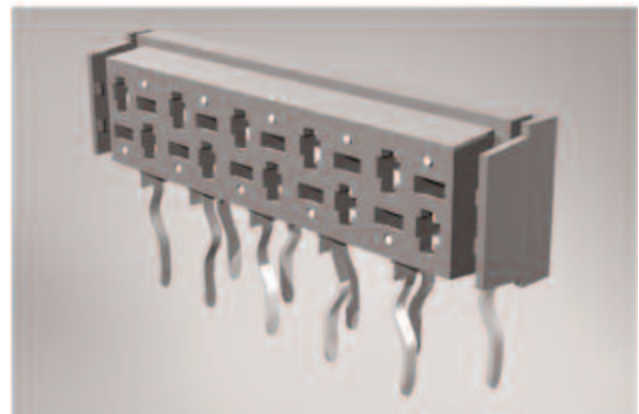

### In-board SMD Part Number 188431

This connector is only tooled in 20 position (9-188431-0) and packaged in embossed tape according to EIA481 standards. The connectors are equipped with a feature for vacuum Pick & Placement. It enables the mounting of a PCB with the solder side direct behind e.g. a display. It is also possible to obtain a parallel BTB application with an extreme low PCB distance of 4.2 mm.

**Mates with:**    **X-338095-X**                      **X-338728-X**  
                          **X-215464-X**                      **X-215083-X**

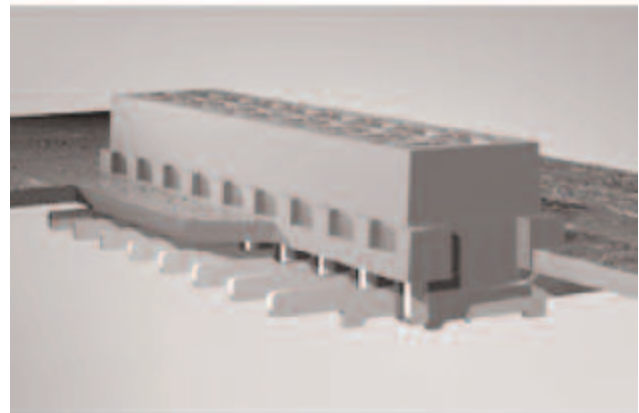

### Male SMD Part Number 338728

This connector enables the possibility to have a full SMD to SMD Board-to-Board application. It mates with all Micro-MaTch female connectors, and will be packaged according EIA 481 standard. Consult TE for more information.

**Mates with:**    **X-215079-X**                      **X-338070-X**  
                          **X-215460-X**                      **X-188431-X**  
                          **X-188275-X**                      **X-338068-X**  
                          **X-338069-X**

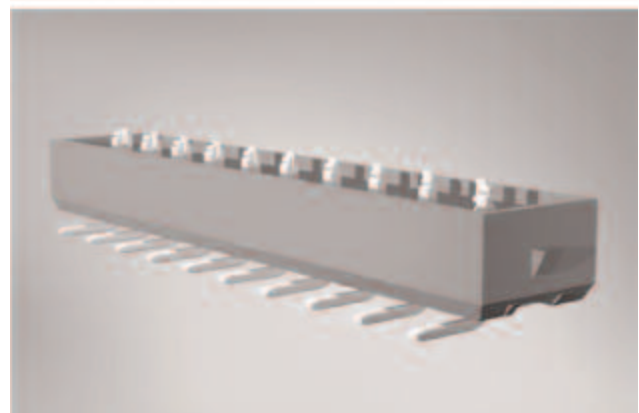



## Micro-MaTch Miniature Connector System Application Tooling



**Pistol Handgrip Tooling.** This is a handtool for terminating Micro-MaTch Male-on-Wire and Paddle Board connectors. Meant for small quantities or repair services. Pistol handgrip and adapter must be ordered separately.

**Standard Pistol Handgrip Part Number 734155-1.** This basic tool can be used for Micro-MaTch and other applications.

**Pistol Handgrip Adapter Set Part Number 734024-1.** This adapter can be used for Micro-MaTch terminations, together with the pistol handgrip.



**Bench Press Tooling Part Number 733280-3.** This complete tool includes a Micro-MaTch dedicated tool set mounted on the bench press 654173-2.

**Bench Press Part Number 91085-2.** This basic press is a hand operated version. This press can also be obtained in a pneumatically operated version; Part Number 91112-3.

**Bench Press Tool Set Part Number 733278-2.** This tool set is designed especially for Micro-MaTch. It fits both pneumatically and hand operated press.



**COSI Hand Tooling Part Number 734870-1** for 24-20 AWG, and **Part Number 734870-2** for 28-24 AWG. These dedicated tools can be obtained for services/repair applications.

**G-terminator Part Number 677-499-1.**

**Applicators for G-terminator. Part Number 677894-1** for AWG 28-24 (Part Number 338096-1) and **Part Number 677895-1** for AWG 24-20 (Part Number 338097-1).

**Micro-MaTch Miniature Connector System Application Tooling** (Continued)**Semiautomatic Tooling Part Number 677410-1.**

This tool can be used for Micro-MaTch lead end and for daisy chain assembly applications.

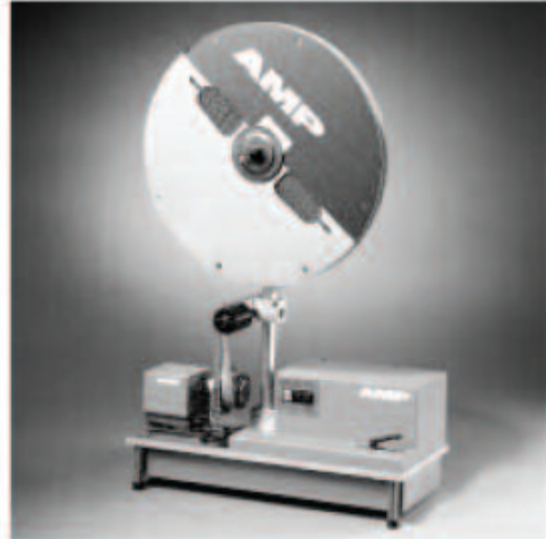

**Semiautomatic Tooling Part Number 677412-5** for Micro-MaTch only and **Part Number 1-677412-0** for both Micro-MaTch and other ribbon cables. This machine can be used for lead end assemblies.

**Connector Dispenser Part Number 677463-1.**

The dispenser accepts the Micro-MaTch standard reels (2500 pcs/reel). It automatically removes the pre-set connector quantity from the reel and drops it in a separate box. Quantity can easily be programmed by the user.

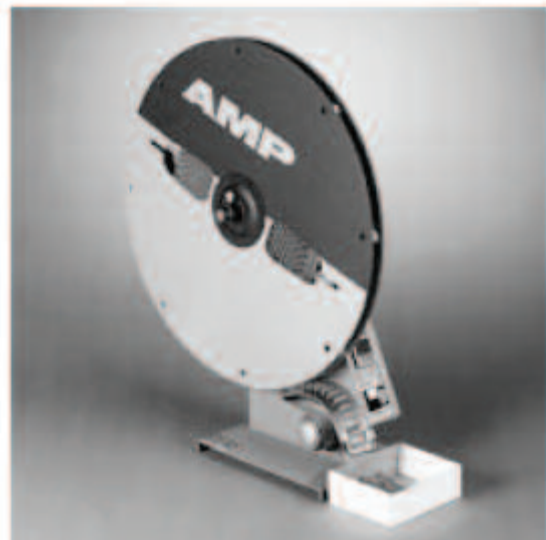

## Micro-MaTch Miniature Connector System Lead Assembly

It is possible to deliver custom made Micro-MaTch lead assemblies, both cable end assemblies and daisy-chain assemblies, in all positions between 4 and 20 in all required cable lengths. All leads are 100% electrically tested on shortcut and connection before shipment. A flexible 7 stranded cable is used for easy assembly. Special cable on request. For order information contact TE.



## Micro-MaTch Miniature Connector System Sample Box

### Sample Box Part Number 1377074-1

This box includes samples of all connector types within the Micro-MaTch family, examples of leads, printed circuit boards and a CD-ROM. The CD-ROM includes an electronic version of this catalogue, an animation of the contact principle and CAD files of all connector types.

This sample box is an aid in visualizing the variety of applications where Micro-MaTch can be implemented.



## Universal I/O Pin Connectors without Mounting Ears

### Material and Finish

**Housing and Cover** — Flame retardant UL 94V-0 rated thermoplastic, black

**Contacts** — Phosphor bronze, .000100 [0.00254] min. tin on termination end, .000030 [0.00762] min. gold on mating end, both over .000050 [0.00127] min. nickel



### Technical Documents

#### Product Specification

108-1336

#### Application Specification

114-7011

#### Instruction Sheets

408-9720

408-6939

- Recognized under the Component Program of the Underwriters Laboratories, Inc. UL File No. E28476



- Certified by the Canadian Standards Association, File No. LR 7189

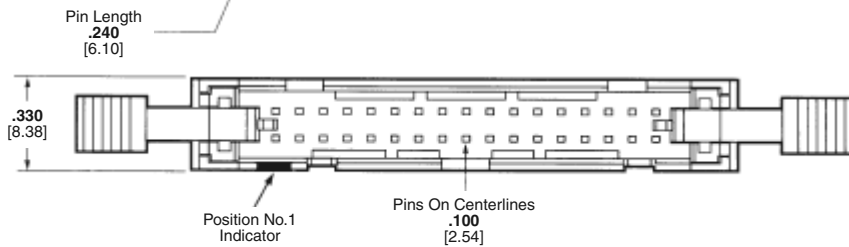
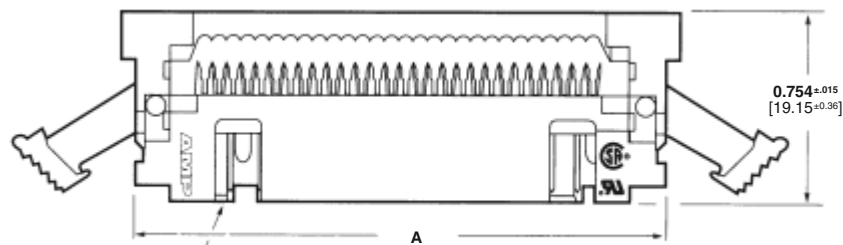
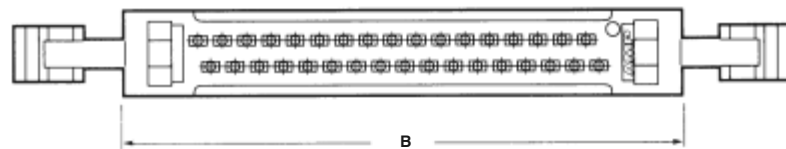

### Accessories

**Strain Relief** — page 67

**Ejector Latch** — page 63

**Military Polarizer** — page 63

Terminates 26 and 28 AWG solid or stranded ribbon cable. See Application Specification for cable requirements.

### Related Product Data

**Mateable Receptacles Novo** — pages 48-51

**Female Socket Connectors** — pages 52-55

No. of Positions	Dimensions		Part Numbers of Connectors with:		
	A	B	No Latches	Short Latches <sup>1</sup>	Long Latches <sup>2</sup>
10 <sup>3,4</sup>	.992 25.20	1.072 27.23	1-111446-4	1-111492-5	1-111504-4
14 <sup>3,4</sup>	1.192 30.28	1.272 32.31	1-111446-5	1-111492-6	1-111504-5
16	1.292 32.82	1.372 34.85	1-111446-6	1-111492-7	1-111504-6
20	1.492 37.90	1.572 39.93	1-111446-8	—	1-111504-7
24	1.692 42.98	1.772 45.01	1-111446-9	1-111492-9	1-111504-8
26	1.792 45.52	1.872 47.55	2-111446-0	2-111492-0	—
30	1.992 50.60	2.072 52.63	2-111446-1	2-111492-1	2-111504-0
34	2.192 55.68	2.272 57.71	2-111446-2	2-111492-2	—
40	2.492 63.30	2.572 65.33	2-111446-3	2-111492-3	—
44	2.692 68.38	2.772 70.41	2-111446-4	2-111492-4	2-111504-3
50	2.992 76.00	3.072 78.03	1-111446-7	2-111492-5	—
60	3.492 88.70	3.572 90.73	2-111446-5	2-111492-6	—
64	3.692 93.78	3.772 95.81	2-111446-6	—	2-111504-6

<sup>1</sup> Use short latch versions when mating connectors without strain reliefs are used.

<sup>2</sup> Use long latch versions when mating connectors with strain reliefs are used.

<sup>3</sup> No slot on end with position No. 1 indicator for 10 and 14-position connectors.

<sup>4</sup> No slot for snap-in polarizer on end with position No. 1 indicator for 10 and 14-position connectors.

**Note:** All part numbers are RoHS compliant.



## Universal I/O Pin Connectors with Slotted Mounting Ears

### Material and Finish

**Housing and Cover** — Flame retardant UL 94V-0 rated thermoplastic, black

**Contacts** — Phosphor bronze, .000100 [0.00254] min. tin on termination end, .000030 [0.00762] min. gold on mating end, both over .000050 [0.00127] min. nickel



### Technical Documents

#### Product Specification

108-1336

#### Application Specification

114-7011

#### Instruction Sheets

408-9720

408-6939

- Recognized under the Component Program of the Underwriters Laboratories, Inc. UL File No. E28476



- Certified by the Canadian Standards Association, File No. LR 7189

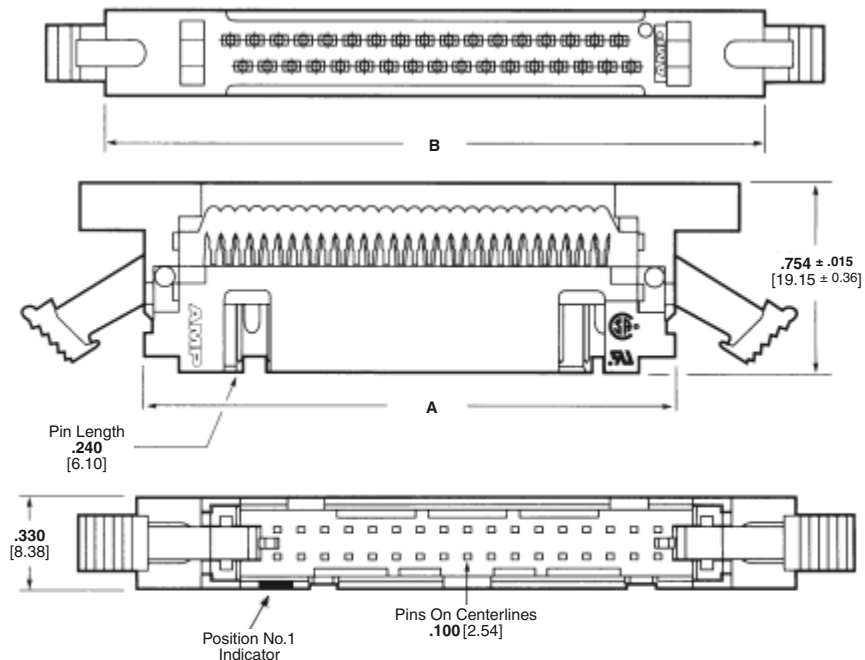

### Accessories

**Ejector Latch** — page 63

**Military Polarizer** — page 63

Terminates 26 and 28 AWG solid or stranded ribbon cable. See Application Specification for cable requirements.

### Related Product Data

**Mateable Receptacles Novo** — pages 48-51

**Female Socket Connectors** — pages 52-55

No. of Positions	Dimensions		Part Numbers of Connectors with:		
	A	B	No Latches	Short Latches <sup>1</sup>	Long Latches <sup>2</sup>
10 <sup>3,4</sup>	.992 25.20	1.476 37.49	5111448-1	1-111494-5	1-111506-6
14 <sup>3,4</sup>	1.192 30.28	1.676 42.57	—	—	—
16	1.292 32.82	1.776 45.11	5111448-3	—	1-111506-8
20	1.492 37.90	1.976 50.19	5111448-4	1-111494-8	—
24	1.692 42.98	2.176 55.27	5111448-5	1-111494-9	2-111506-0
26	1.792 45.52	2.276 57.81	—	—	2-111506-1
30	1.992 50.60	2.476 62.89	5111448-7	2-111494-0	—
34	2.192 55.68	2.676 67.97	5111448-8	2-111494-1	—
40	2.492 63.30	2.976 75.59	5111448-9	2-111494-2	2-111506-4
44	2.692 68.38	3.176 80.67	—	2-111494-3	2-111506-5
50	2.992 76.00	3.476 88.29	—	2-111494-4	1-111506-4
60	3.492 88.70	3.976 100.99	—	2-111494-5	—
64	3.692 93.78	4.176 106.07	1-5111448-3	2-111494-6	—

<sup>1</sup> Use short latch versions when mating connectors without strain reliefs are used.

<sup>2</sup> Use long latch versions when mating connectors with strain reliefs are used.

<sup>3</sup> No slot on end with position No. 1 indicator for 10 and 14-position connectors.

<sup>4</sup> No slot for snap-in polarizer on end with position No. 1 indicator for 10 and 14-position connectors.

**Note:** All part numbers are RoHS compliant.

## EUROLATCH Receptacles, 64-Position (Three-Row Housings, Two Rows Loaded)

### Housing Assembly with Cover (Preassembled)

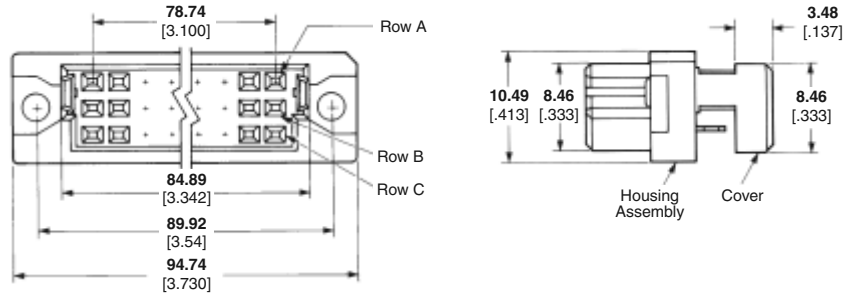

### Material and Finish

**Housing and Cover** — UL 94V-0 rated thermoplastic, black

**Contacts** — Phosphor bronze, duplex plated 0.00076 [0.00030] gold on post/pin mating end, 0.00254-0.00508 [0.00100-.00200] tin on termination end, with entire contact underplated 0.00127 [0.00050] nickel.

### Related Product Data

**Mateable Pin Connectors** — Eurocard Type C and Type R— Selection Guide 82650, See Catalog 82721

**Ribbon Cable** — Part Number 2-57040-2 or Part Number 2-57034-5 (64 conductor)

**Application Tooling** — pages 70-74

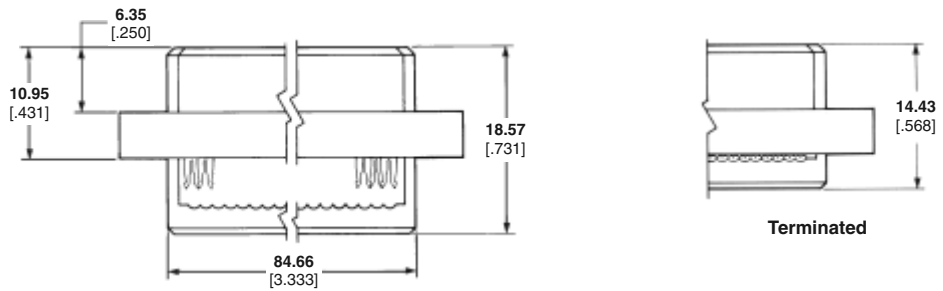

### Technical Documents

**Product Specifications**  
108-46003 EUROLATCH Receptacles  
DIN 41612  
IEC 603-2

**Instruction Sheet**  
408-9156

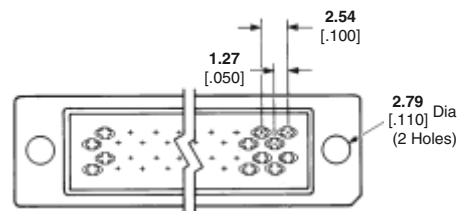

■ **Recognized under the Component Program of the Underwriters Laboratories, Inc.** **UL File No. E28476**

■ **Certified by the Canadian Standards Association,** **File No. LR 7189**



Contact Rows Loaded	Receptacle Kit No. (Preassembled)
A and C	746603-4

**Note:** All part numbers are RoHS compliant.



## Novo Connectors

### Product Facts

- .100 x .100 [2.54 x 2.54] mating grid for .050 [1.27] pitch ribbon cable
- Tuning fork contact offers a military approved design, at an economical cost
- Polarization options include military, center and military, and dual bar
- Choice of duplex gold plating on contact mating area
- Insulation displacement contacts for fast, economical mass terminations
- Contact design provides uniform latching of contacts and housing with connector cover
- Housing, cover and strain relief made of UL 94V-0 rated thermoplastic material
- Selected 10 thru 64-position configurations available
- Accepts wire size range 28-26 AWG [0.08-0.15 mm<sup>2</sup>], solid or stranded
- Snap-on strain relief and choice of pull loops available
- One-step termination with Novo tooling
- Recognized under the Component Program of the Underwriters Laboratories, Inc.  UL File No. E28476
- Certified by the Canadian Standards Association,  File No. LR 7189

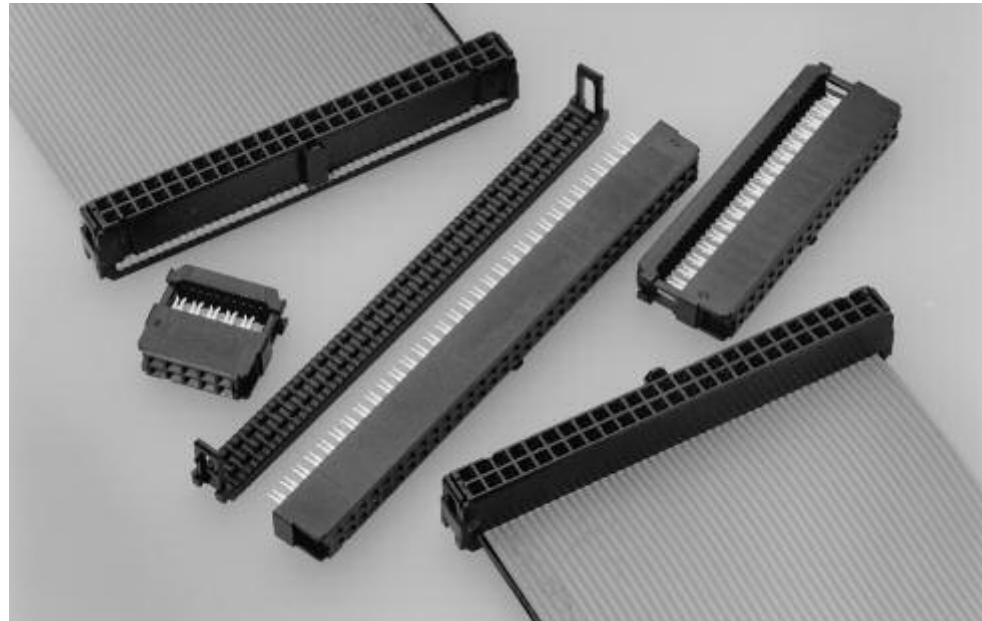

Novo receptacles offer a dual contact interface with all normal force created by metal-to-metal contact. This provides a higher degree of contact reliability.

Novo receptacles feature two rows of contacts on .100 x .100 [2.54 x 2.54] centerlines in select sizes from 10 to 64 positions. Contacts mate with .025<sup>2</sup> [0.64<sup>2</sup>] or round posts with .245 [6.22] max. and .175 [4.45] min. lengths. The Novo tuning fork contact offers a military-approved design, and at a lower cost.

Contacts are made of phosphor bronze and are available in a choice of duplex .000015 [0.00038] or .000030 [0.00076] gold in the mating area, and .000100 [0.00254] tin in the termination area, with the entire contact underplated with .000050 [0.00127] nickel.

Housings are made of UL 94V-0 thermoplastic material and feature military, military and center, and dual bar polarization.

Optional accessories include a snap-on strain relief and pull loops.

Novo receptacles can be terminated to .050 [1.27] pitch ribbon cable by a wide variety of one-step application tooling.

Assemblies are packaged in tubes for ease of handling, protection and termination.

## Novo Receptacles, Military Polarized\* .100 x .100 [2.54 x 2.54] Centers

### Housing Assembly with Cover (Preassembled) and Strain Relief (Optional)

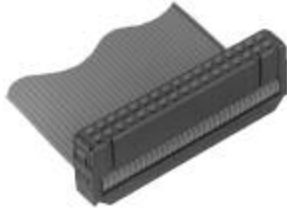

Contacts mate with .025 [0.64] sq. or round pins with .245 [6.22] max. and .175 [4.45] min. lengths.

### Material and Finish

**Housing, Cover & Strain Relief** — UL 94V-0 rated thermoplastic, black  
**Contacts** — Phosphor bronze, duplex plated (See chart below)

### Related Product Data

**Mateable Pin Headers** — Universal — pages 84-95  
**Low Profile** — pages 76-83  
**Mateable Universal I/O Pin Connectors** — pages 45 and 46

### Accessories

**Pull Tabs** — page 63  
**Keying Plug** — page 64  
**Pull Loops** — page 66  
**Strain Relief Dimensional Information** — page 68  
**Application Tooling** — pages 70-74

### Technical Documents

**Product Specifications**  
 108-40000 Novo and Novo Stackable Receptacles; 108-40004 Ribbon Cable, PVC Insulated

**Application Specification**  
 114-40005 Ribbon Cable Connectors

### Instruction Sheets

Instructional material covering operation, setup, maintenance, repair, etc. is included with each machine, tool or die set. If this material is required prior to receiving your tooling, call TE at the numbers listed below for the applicable documents.

\*These receptacles can be used in applications requiring non-polarization, as well as military polarization.

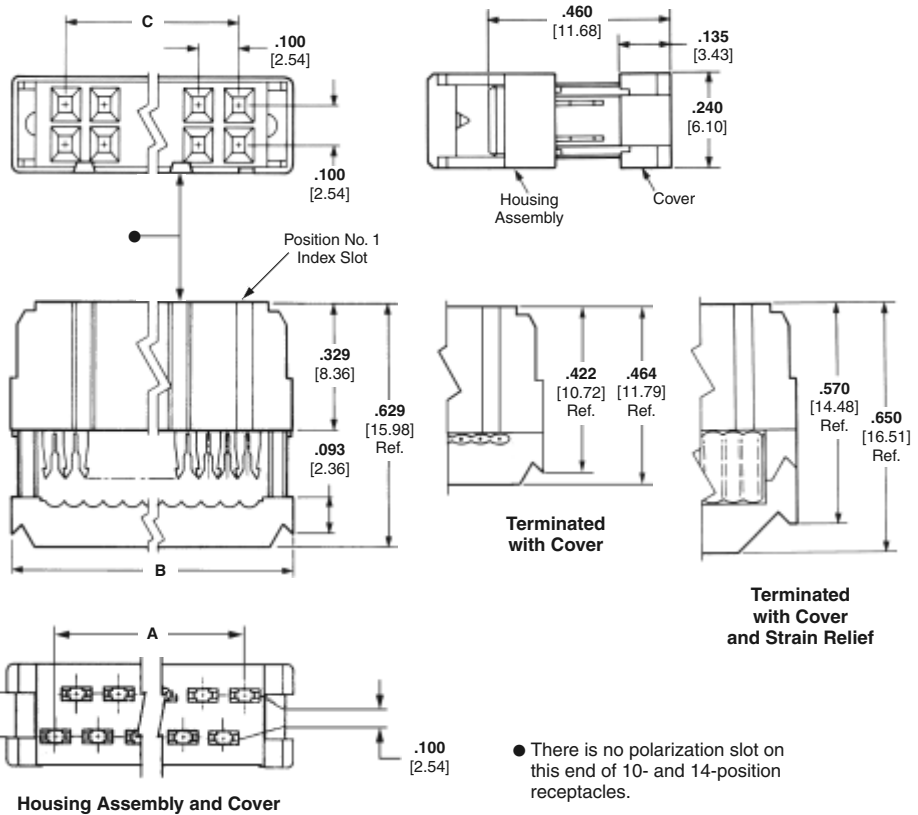

No. of Pos.	Dimensions			Contact Plating	Strain Relief Part No.	Receptacle (Preassembled)
	A	B	C			
10	.450	.680	.400	Duplex <sup>1</sup>	499252-5	1658620-1
	11.43	17.27	10.16	Duplex <sup>2</sup>	499252-5	1658623-1
14	.650	.880	.600	Duplex <sup>1</sup>	499252-9	1658620-2
	16.51	22.35	15.24	Duplex <sup>2</sup>	499252-9	1658623-2
16	.750	.980	.700	Duplex <sup>1</sup>	499252-8	1658620-3
	19.05	24.89	17.78	Duplex <sup>2</sup>	499252-8	1658623-3
20	.950	1.180	.900	Duplex <sup>1</sup>	499252-2	1658620-4
	24.13	29.97	22.86	Duplex <sup>2</sup>	499252-2	1658623-4
24	1.150	1.380	1.100	Duplex <sup>1</sup>	1-499252-0	1658620-5
	29.21	35.05	27.94	Duplex <sup>2</sup>	1-499252-0	1658623-5
26	1.250	1.480	1.200	Duplex <sup>1</sup>	499252-3	1658620-6
	31.75	37.59	30.48	Duplex <sup>2</sup>	499252-3	1658623-6
30	1.450	1.680	1.400	Duplex <sup>1</sup>	1-499252-2	1658620-7
	36.83	42.67	35.56	Duplex <sup>2</sup>	1-499252-2	1658623-7
34	1.650	1.880	1.600	Duplex <sup>1</sup>	499252-6	1658620-8
	41.91	47.75	40.64	Duplex <sup>2</sup>	499252-6	1658623-8
40	1.950	2.180	1.900	Duplex <sup>1</sup>	499252-1	1658620-9
	49.53	55.37	48.26	Duplex <sup>2</sup>	499252-1	1658623-9
50	2.450	2.680	2.400	Duplex <sup>1</sup>	499252-4	1-1658620-0
	62.23	68.07	60.96	Duplex <sup>2</sup>	499252-4	1-1658623-0
60	2.950	3.180	2.900	Duplex <sup>1</sup>	499252-7	—
	74.93	80.77	73.66	Duplex <sup>2</sup>	499252-7	—
64	3.150	3.380	3.100	Duplex <sup>1</sup>	1-499252-3	1-1658620-2
	80.01	85.85	78.74	Duplex <sup>2</sup>	1-499252-3	—

<sup>1</sup>.000015 [0.00038] gold or gold flash over palladium-nickel .000015 [0.00038] min. total on post/pin mating end, .000100-.000200 [0.00254-0.00508] tin on termination end, with entire contact underplated .000050 [0.00127] nickel.  
<sup>2</sup>.000030 [0.00076] gold or gold flash over palladium-nickel .000030 [0.00076] min. total on post/pin mating end, .000100-.000200 [0.00254-0.00508] tin on termination end, with entire contact underplated .000050 [0.00127] nickel.  
**Note:** These receptacles include a housing assembly and cover (preassembled). Strain reliefs may be purchased separately using the component part nos. listed above. All part numbers are RoHS compliant.

## Novo Receptacles, Center and Military Polarized\* .100 x .100 [2.54 x 2.54] Centers

### Housing Assembly with Cover (Preassembled) and Strain Relief (Optional)



Contacts mate with .025 [0.64] sq. or round pins with .245 [6.22] max. and .175 [4.45] min. lengths.

### Material and Finish

**Housing, Cover & Strain Relief** — UL 94V-0 rated thermoplastic, black

**Contacts** — Phosphor bronze, duplex plated (See chart below)

### Related Product Data

**Mateable Pin Headers** —

**Universal** — pages 84-95

**Low Profile** — pages 76-83

**Mateable Universal I/O Pin Connectors** — pages 45 and 46

### Accessories

**Pull Tabs** — page 63

**Keying Plug** — page 64

**Pull Loops** — page 66

**Strain Relief** — page 68

**Application Tooling** — pages 70-74

### Technical Documents

#### Product Specifications

108-40000 Novo and Novo Stackable Receptacles; 108-40004 Ribbon Cable, PVC Insulated

#### Application Specification

114-40005 Novo Receptacles

#### Instruction Sheets

Instructional material covering operation, setup, maintenance, repair, etc. is included with each machine, tool or die set. If this material is required prior to receiving your tooling, call TE at the numbers listed below for the applicable documents.

\*These receptacles can be used in applications requiring center polarization.

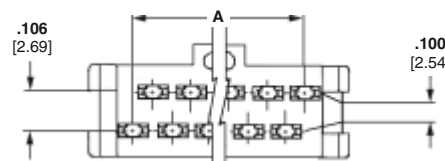
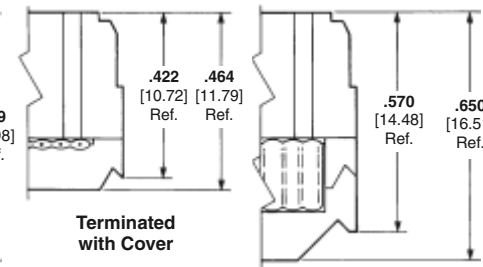
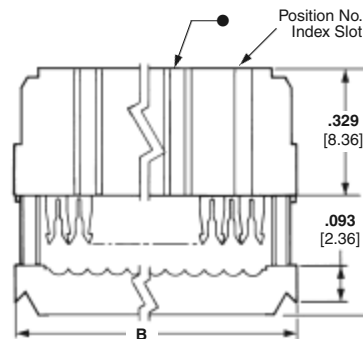
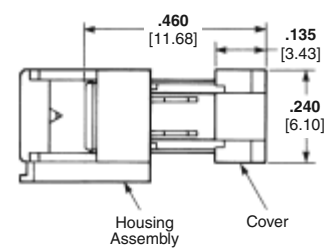
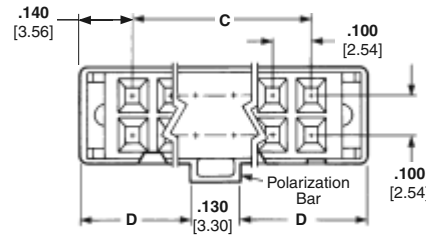

Housing Assembly and Cover

● There is no polarization slot on this end of 10- and 14-position receptacles.

No. of Pos.	Dimensions				Contact Plating	Strain Relief Part No.	Receptacle (Preassembled)
	A	B	C	D			
10	.450	.680	.400	.275	Duplex <sup>1</sup>	499252-5	1658621-1
	11.43	17.27	10.16	6.99	Duplex <sup>2</sup>	499252-5	1658622-1
14	.650	.880	.600	.375	Duplex <sup>1</sup>	499252-9	1658621-2
	16.51	22.35	15.24	9.53	Duplex <sup>2</sup>	499252-9	1658622-2
16	.750	.980	.700	.425	Duplex <sup>1</sup>	499252-8	1658621-3
	19.05	24.89	17.78	10.80	Duplex <sup>2</sup>	499252-8	1658622-3
20	.950	1.180	.900	.525	Duplex <sup>1</sup>	499252-2	1658621-4
	24.13	29.97	22.86	13.34	Duplex <sup>2</sup>	499252-2	1658622-4
24	1.150	1.380	1.100	.625	Duplex <sup>1</sup>	1-499252-0	1658621-5
	29.21	35.05	27.94	15.88	Duplex <sup>2</sup>	1-499252-0	1658622-5
26	1.250	1.480	1.200	.675	Duplex <sup>1</sup>	499252-3	1658621-6
	31.75	37.59	30.48	17.15	Duplex <sup>2</sup>	499252-3	1658622-6
30	1.450	1.680	1.400	.775	Duplex <sup>1</sup>	1-499252-2	1658621-7
	36.83	42.67	35.56	19.69	Duplex <sup>2</sup>	1-499252-2	1658622-7
34	1.650	1.880	1.600	.875	Duplex <sup>1</sup>	499252-6	1658621-8
	41.91	47.75	40.64	22.23	Duplex <sup>2</sup>	499252-6	1658622-8
40	1.950	2.180	1.900	1.025	Duplex <sup>1</sup>	499252-1	1658621-9
	49.53	55.37	48.26	26.04	Duplex <sup>2</sup>	499252-1	1658622-9
50	2.450	2.680	2.400	1.275	Duplex <sup>1</sup>	499252-4	1-1658621-0
	62.23	68.07	60.96	32.39	Duplex <sup>2</sup>	499252-4	1-1658622-0
60	2.950	3.180	2.900	1.525	Duplex <sup>1</sup>	499252-7	1-1658621-1
	74.93	80.77	73.66	38.74	Duplex <sup>2</sup>	499252-7	1-1658622-1
64	3.150	3.380	3.100	1.625	Duplex <sup>1</sup>	1-499252-3	1-1658621-2
	80.01	85.85	78.74	41.28	Duplex <sup>2</sup>	1-499252-3	1-1658622-2

<sup>1</sup>.000015 [0.00038] gold or gold flash over palladium-nickel .000015 [0.00038] min. total on post/pin mating end, .000100-.000200 [0.00254-0.00508] tin on termination end, with entire contact underplated .000050 [0.00127] nickel.

<sup>2</sup>.000030 [0.00076] gold or gold flash over palladium-nickel .000030 [0.00076] min. total on post/pin mating end, .000100-.000200 [0.00254-0.00508] tin on termination end, with entire contact underplated .000050 [0.00127] nickel.

**Note:** These receptacles include a housing assembly and cover (preassembled). Strain reliefs may be purchased separately using the component part nos. listed above.

All part numbers are RoHS compliant.

## Novo Receptacles, Dual Polarized, .100 x .100 [2.54 x 2.54] Centers

### Housing Assembly with Recessed Cover (Preassembled) and Strain Relief (Optional)

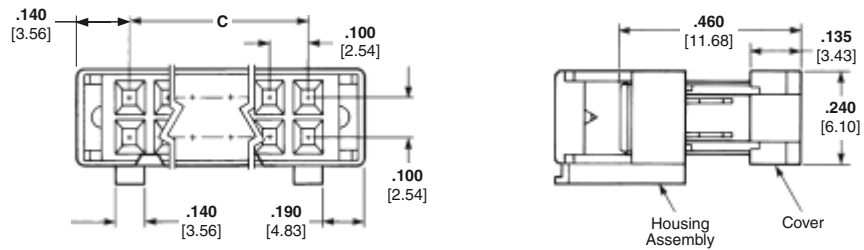

### Material and Finish

#### Housing, Cover & Strain Relief —

UL 94V-0 rated thermoplastic, black  
**Contacts** — Phosphor bronze, duplex plated .000030 [0.00076] gold or gold flash over palladium-nickel .000030 [0.00076] min. total on post/pin mating end, .000100-.000200 [0.00254-.0.00508] tin on termination end, with entire contact underplated .000050 [0.00127] nickel.

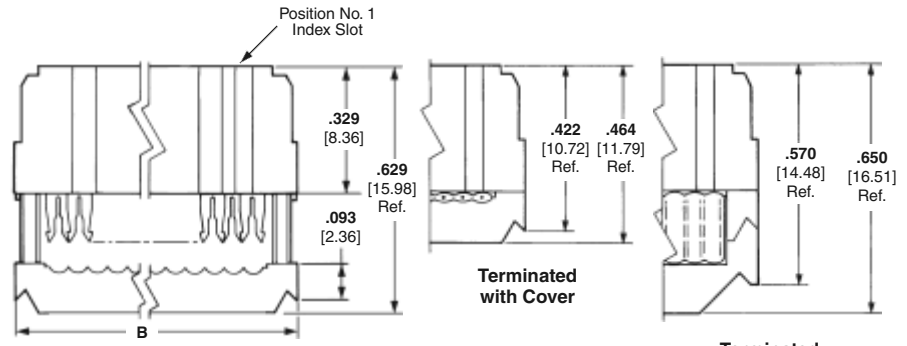

### Related Product Data

- Mateable Pin Headers** —
- Universal** — pages 84-95
- Low Profile** — pages 76-83
- Mateable Universal I/O Pin Connectors** — pages 45 and 46

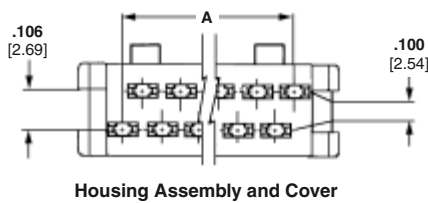

### Accessories

- Pull Tabs** — page 63
- Keying Plug** — page 64
- Pull Loops** — page 66
- Strain Relief** — page 68
- Application Tooling** — pages 70-74

### Technical Documents

- Product Specifications**  
108-40000 Novo and Novo Stackable Receptacles; 108-40004 Ribbon Cable, PVC Insulated
- Application Specification**  
114-40005 Novo Receptacles
- Instruction Sheets**  
Instructional material covering operation, setup, maintenance, repair, etc. is included with each machine, tool or die set. If this material is required prior to receiving your tooling, call TE at the numbers listed below for the applicable documents.

No. of Pos.	Dimensions			Strain Relief Part No.	Receptacle (Preassembled)
	A	B	C		
10	.450 11.43	.680 17.27	.400 10.16	499252-5	1658624-1
14	.650 16.51	.880 22.35	.600 15.24	499252-9	1658624-2
16	.750 19.05	.980 24.89	.700 17.78	499252-8	1658624-3
20	.950 24.13	1.180 29.97	.900 22.86	499252-2	1658624-4
24	1.150 29.21	1.380 35.05	1.100 27.94	1-499252-0	1658624-5
26	1.250 31.75	1.480 37.59	1.200 30.48	499252-3	1658624-6
30	1.450 36.83	1.680 42.67	1.400 35.56	1-499252-2	1658624-7
34	1.650 41.91	1.880 47.75	1.600 40.64	499252-6	1658624-8
40	1.950 49.53	2.180 55.37	1.900 48.26	499252-1	1658624-9
50	2.450 62.23	2.680 68.07	2.400 60.96	499252-4	1-1658624-0
64	3.150 80.01	3.380 85.85	3.100 78.74	1-499252-3	1-1658624-2

**Note:** All part numbers are RoHS compliant.

## Female Socket Connectors, .100 x .100 [2.54 x 2.54] Centers, 622 and 636 Series

### Technical Data

**Color** — 622 Series, Blue; 636 Series, Black

**Contact Material** — 622 Series, Beryllium copper; 636 Series, Phosphor bronze

**Contact Plating** — 622 Series, .000030 [0.00076] min. gold on mating end, .000100-.000200 [0.00254-0.00508] tin on termination end, both over .000050 [0.00127] nickel underplate; 636 Series, .000015 [0.00038] min. gold on mating end, .000100-.000200 [0.00254-0.00508] tin on termination end, both over .000050 [0.00127] nickel underplate.

**Housing Material** — Glass-filled thermoplastic, UL 94V-0 rated

**Cable** — 26-28 AWG solid or stranded, PVC insulated ribbon cable

**Mateable Connectors** — **Universal and Low Profile Pin Headers** — pages 76-95

**Universal I/O Ribbon Cable Connectors** — pages 45 and 46

**Polarization** — Military and center polarized only

■ **Recognized under the Component Program of the Underwriters Laboratories, Inc.** UL File No. E60980



■ **Certified by the Canadian Standards Association,** File No. LR 92984

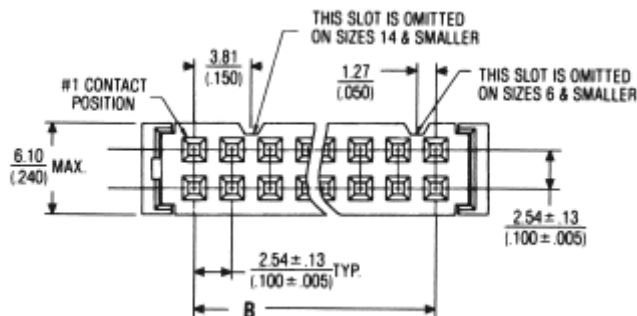
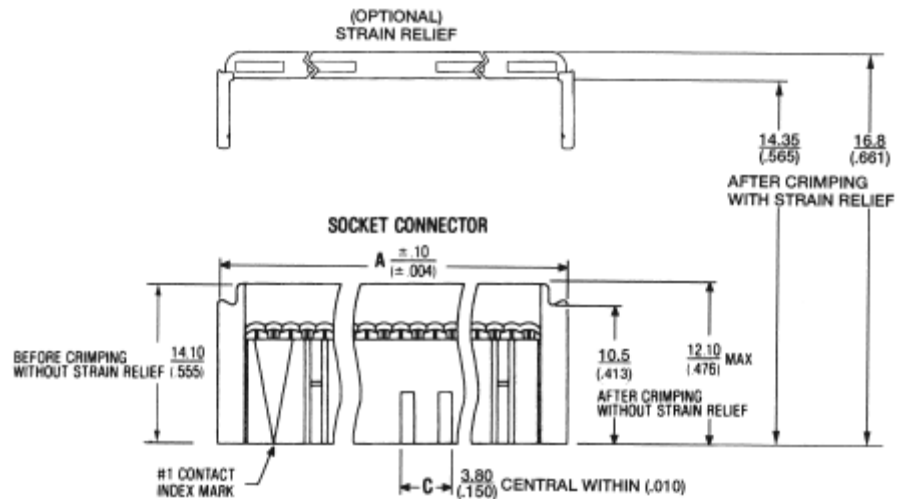

### Application Tooling

**Die** — 1437000-9 [T&B# 779-2151 ref.]

**Handtool** — 1437000-6 [T&B# 779-2100 ref.]

**Bench Press (Manual)** — 1437001-4 [T&B# 779-3200 ref.]

**Bench Press Platen** — 5-1437000-6 [T&B# 779-3130 ref.]

**Bench Press Base Plate** — 6-1437000-4 [T&B# 779-3151 ref.]

### Accessories

**Strain Relief** — page 69

**Pull Loops** — page 66

**Keying Plug** — page 64





## Female Socket Connectors, .100 x .100 [2.54 x 2.54] Centers, 622 and 636 Series (Continued)

### 622 Series

No. of Pos.	Dimensions			Part Numbers			
				Connector Only		Connector w/ Strain Relief	
	A	B	C	TE Connectivity	T&B (Reference Only)	TE Connectivity	T&B (Reference Only)
6	.477 12.12	.200 5.08	.075 1.91	1658527-2	622-0630LF	1-1658527-9	622-0641LF
10	.677 17.20	.400 10.16	.126 3.20	1658527-3	622-1030LF	1658527-4	622-1041LF
12	.777 19.74	.500 12.70	.150 3.81	2-1658527-0	622-1230LF	—	—
14	.877 22.28	.600 15.24	.150 3.81	1658527-5	622-1430LF	2-1658527-2	622-1441LF
16	.977 24.82	.700 17.78	.150 3.81	1658527-6	622-1630LF	1658527-7	622-1641LF
20	1.177 29.90	.900 22.86	.150 3.81	2-1658527-3	622-2030LF	1658527-8	622-2041LF
24	1.377 34.98	1.100 27.94	.150 3.81	—	—	2-1658527-5	622-2441LF
26	1.477 37.52	1.200 30.48	.150 3.81	1658527-9	622-2630LF	1-1658527-0	622-2641LF
30	1.677 42.60	1.400 35.56	.150 3.81	—	—	2-1658527-7	622-3041LF
34	1.877 47.68	1.600 40.64	.150 3.81	—	—	2-1658527-8	622-3441LF
40	2.177 55.30	1.900 48.26	.150 3.81	1-1658527-2	622-4030LF	1-1658527-3	622-4041LF
50	2.677 68.00	2.400 60.96	.150 3.81	1-1658527-4	622-5030LF	1-1658527-5	622-5041LF
64	3.377 85.78	3.100 78.74	.150 3.81	—	—	3-1658527-2	622-6441LF

**Note:** Order by TE Part Number only. Original non-RoHS compliant T&B number may be determined by dropping the "LF" suffix.

### 636 Series

No. of Pos.	Dimensions			Part Numbers			
				Connector Only		Connector w/ Strain Relief	
	A	B	C	TE Connectivity	T&B (Reference Only)	TE Connectivity	T&B (Reference Only)
6	.477 12.12	.200 5.08	.075 1.91	1-1658528-0	636-0630LF	—	—
10	.677 17.20	.400 10.16	.126 3.20	1-1658528-1	636-1030LF	1658528-2	636-1041LF
14	.877 22.28	.600 15.24	.150 3.81	1-1658528-2	636-1430LF	—	—
16	.977 24.82	.700 17.78	.150 3.81	1-1658528-4	636-1630LF	1658528-5	636-1641LF
20	1.177 29.90	.900 22.86	.150 3.81	1-1658528-5	636-2030LF	1658528-4	636-2041LF
24	1.377 34.98	1.100 27.94	.150 3.81	1-1658528-6	636-2430LF	—	—
26	1.477 37.52	1.200 30.48	.150 3.81	1-1658528-7	636-2630LF	—	—
34	1.877 47.68	1.600 40.64	.150 3.81	—	—	1658528-6	636-3441LF
40	2.177 55.30	1.900 48.26	.150 3.81	—	—	1-1658528-9	636-4041LF
50	2.677 68.00	2.400 60.96	.150 3.81	2-1658528-0	636-5030LF	1658528-8	636-5041LF
64	3.377 85.78	3.100 78.74	.150 3.81	—	—	2-1658528-3	636-6441LF

**Note:** Order by TE Part Number only. Original non-RoHS compliant T&B number may be determined by dropping the "LF" suffix.

**Note:** All part numbers are RoHS compliant.



## Female Socket Connectors, .100 x .100 [2.54 x 2.54] Centers, 609 Series

### Technical Data

**Color** — Blue

**Contact Material** — Beryllium copper

**Contact Plating** — .000030 [0.00076] min. gold on mating end, .000100-.000200 [0.00254-0.00508] tin on termination end, both over .000050 [0.00127] nickel underplate.

**Housing Material** — Glass-filled thermoplastic, UL 94V-0 rated

**Cable** — 28-30 AWG solid or stranded, PVC insulated ribbon cable

**Mateable Connectors** — **Universal and Low Profile Pin Headers** — pages 76-95

**Universal I/O Ribbon Cable Connectors** — pages 45 and 46

**Polarization** — Military only or military and center polarized

■ **Recognized under the Component Program of the Underwriters Laboratories, Inc.** UL File No. E60980



■ **Certified by the Canadian Standards Association,** File No. LR 92984



### Application Tooling

**Die** — 1437000-9 [T&B# 779-2151 ref.]

**Handtool** — 1437000-6 [T&B# 779-2100 ref.]

**Bench Press (Manual)** — 1437001-4 [T&B# 779-3200 ref.]

**Bench Press Platen** — 5-1437000-6 [T&B# 779-3130 ref.]

**Bench Press Base Plate** — 6-1437000-4 [T&B# 779-3151 ref.]

### Accessories

**Strain Relief** — page 67

**Pull Loops** — page 66

**Keying Plug** — page 64

### Dual Slot IDC Design

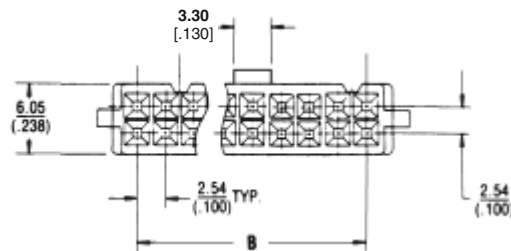
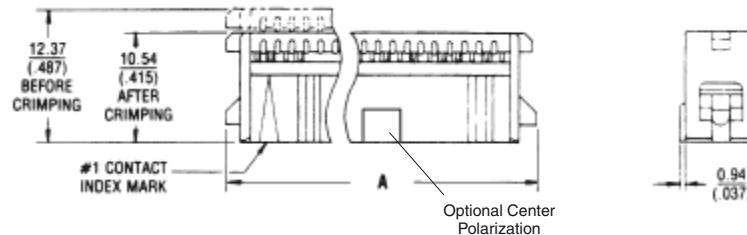

Standard Socket Connector Without Strain Relief

**Note:** All part numbers are RoHS compliant.

## Female Socket Connectors, .100 x .100 [2.54 x 2.54] Centers, 609 Series (Continued)

### 609 Series, Military Polarized

No. of Pos.	Dimensions			Part Numbers			
				Connector Only		Connector w/ Strain Relief	
	A	B	C	TE Connectivity	T&B (Reference Only)	TE Connectivity	T&B (Reference Only)
6	.476 12.09	.200 5.08	.392 9.96	2-1658526-5	609-0600MLF	—	—
10	.676 17.17	.400 10.16	.592 15.04	1658526-3	609-1000MLF	—	—
16	.976 24.79	.700 17.78	.892 22.66	—	—	1-1658526-0	609-1601MLF
20	1.176 29.87	.900 22.86	1.092 27.74	3-1658526-0	609-2000MLF	—	—
26	1.476 37.49	1.200 30.48	1.392 35.36	3-1658526-5	609-2600MLF	—	—
40	2.176 55.27	1.900 48.26	2.092 53.14	4-1658526-1	609-4000MLF	—	—
50	2.676 67.97	2.400 60.96	2.592 65.84	4-1658526-3	609-5000MLF	2-1658526-2	609-5001MLF

**Note:** Order by TE Part Number only. Original non-RoHS compliant T&B number may be determined by dropping the "LF" suffix.

### 609 Series, Military and Center Polarized

No. of Pos.	Dimensions			Part Numbers			
				Connector Only		Connector w/ Strain Relief	
	A	B	C	TE Connectivity	T&B (Reference Only)	TE Connectivity	T&B (Reference Only)
6	.476 12.09	.200 5.08	.392 9.96	1658526-1	609-0630LF	1658526-2	609-0641LF
10	.676 17.17	.400 10.16	.592 15.04	1658526-4	609-1030LF	1658526-5	609-1041LF
14	.876 22.25	.600 15.24	.792 20.12	1658526-8	609-1430LF	1658526-9	609-1441LF
16	.976 24.79	.700 17.78	.892 22.66	2-1658526-9	609-1630LF	1-1658526-1	609-1641LF
20	1.176 29.87	.900 22.86	1.092 27.74	1-1658526-2	609-2030LF	1-1658526-3	609-2041LF
24	1.376 34.95	1.100 27.94	1.292 32.82	1-1658526-4	609-2430LF	—	—
26	1.476 37.49	1.200 30.48	1.392 35.36	1-1658526-5	609-2630LF	1-1658526-6	609-2641LF
34	1.876 47.65	1.600 40.64	1.792 45.52	1-1658526-8	609-3430LF	1-1658526-9	609-3441LF
36	1.976 50.19	1.700 43.18	1.892 48.06	3-1658526-8	609-3630LF	4-1658526-0	609-3641LF
40	2.176 55.27	1.900 48.26	2.092 53.14	2-1658526-0	609-4030LF	2-1658526-1	609-4041LF
50	2.676 67.97	2.400 60.96	2.592 65.84	2-1658526-3	609-5030LF	2-1658526-4	609-5041LF
64	3.376 85.75	3.100 78.74	3.292 83.62	4-1658526-4	609-6430LF	4-1658526-5	609-6441LF

**Note:** Order by TE Part Number only. Original non-RoHS compliant T&B number may be determined by dropping the "LF" suffix.

**Note:** All part numbers are RoHS compliant.

.050 [1.27] Centerline Ribbon Cable Connectors  
Female Socket Connectors, .100 x .100 [2.54 x 2.54] Centers, 609 Series

## DIP Plugs, .100 x .100 [2.54 x 2.54] Centers, 609 Series

### Technical Data

**Color** — Blue

**Contact Material** — Beryllium copper

**Contact Plating** — .000100-.000200 [0.00254-0.00508] tin over .000050 [0.00127] nickel underplate.

**Contact Design** — Dual slot, barrel shaped (“tulip”) IDC with solder tail

**Housing Material** — Glass-filled thermoplastic, UL 94V-0 rated

**Cable** — 28-30 AWG solid or stranded, PVC insulated ribbon cable

**Mateable Connectors** —  
.100 x .100 DIP sockets

### Application Tooling

**Die** —

1-1437000-3 [T&B# 779-2153 ref.]

**Handtool** —

1437000-6 [T&B# 779-2100 ref.]

**Bench Press (Manual)** —

1437001-4 [T&B# 779-3200 ref.]

**Bench Press Platen** —

5-1437000-6 [T&B# 779-3130 ref.]

**Bench Press Base Plate** —

6-1437000-7 [T&B# 779-3153 ref.]

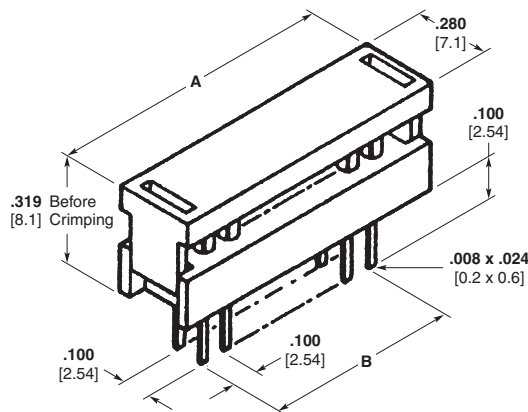

No. of Pos.	Dimensions		Part Numbers	
	A	B	TE Connectivity	T&B (Reference Only)
6	.512 13.00	.200 5.08	1437006-4	609-0653
10	.713 18.11	.400 10.16	1437006-7	609-1053
14	.913 23.19	.600 15.24	1-1437006-0	609-1453
16	1.010 25.65	.700 17.78	1-1437006-3	609-1653
20	1.213 30.81	.900 22.86	1-1437006-6	609-2053
26	1.512 38.40	1.200 30.48	2-1437006-1	609-2653
34	1.913 48.59	1.600 40.64	2-1437006-4	609-3453

**Note:** Order by TE Part Number only. All part numbers listed above are found on TE customer drawing 1437006-4.

**Note:** All part numbers are RoHS compliant.

## DIP Plugs, .100 x .100 [2.54 x 2.54] Centers, 622 Series



### Technical Data

**Color** — Blue

**Contact Material** — Beryllium copper

**Contact Plating** — .000100-.000200 [0.00254-0.00508] tin over .000050 [0.00127] nickel underplate.

**Contact Design** — Single slot, flat, tuning fork style IDC with solder tail

**Housing Material** — Glass-filled thermoplastic, UL 94V-0 rated

**Cable** — 26-28 AWG solid or stranded, PVC insulated ribbon cable

**Mateable Connectors** — .100 x .100 DIP sockets

### Application Tooling

**Die** —

1-1437000-3 [T&B# 779-2153 ref.]

**Handtool** —

1437000-6 [T&B# 779-2100 ref.]

**Bench Press (Manual)** —

1437001-4 [T&B# 779-3200 ref.]

**Bench Press Platen** —

6-1437000-1 [T&B# 779-3133 ref.]

**Bench Press Base Plate** —

6-1437000-7 [T&B# 779-3153 ref.]

### Accessories

**Strain Relief** — page 65

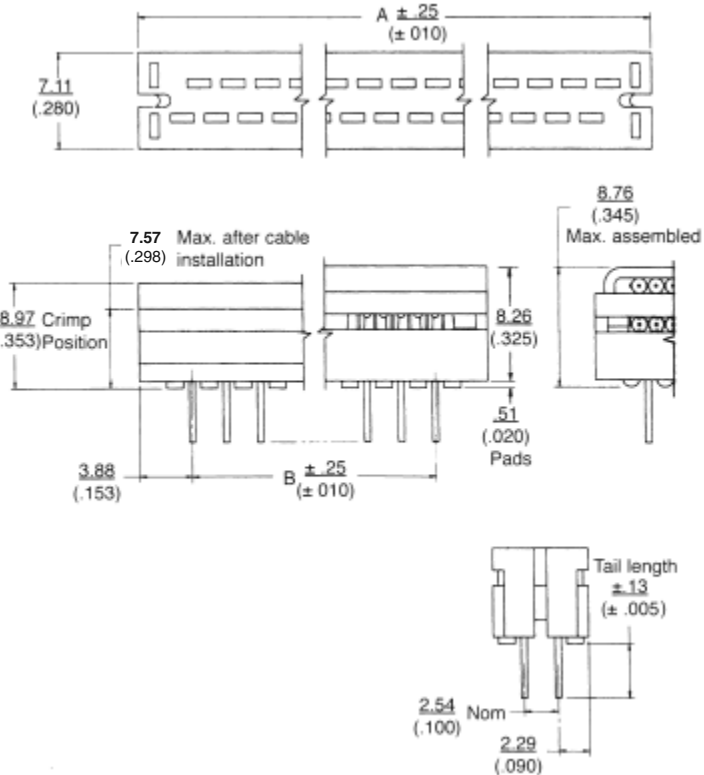

No. of Pos.	Dimensions		Part Numbers	
	A	B	TE Connectivity	T&B (Reference Only)
6	.506 12.85	.200 5.08	1658525-4	622-0653LF
8	.606 15.39	.300 7.62	1658525-5	622-0853LF
10	.706 17.93	.400 10.16	1658525-6	622-1053LF
14	.906 23.01	.600 15.24	1658525-7	622-1453LF
16	1.006 25.55	.700 17.78	1658525-8	622-1653LF
20	1.206 30.63	.900 22.86	1658525-9	622-2053LF
24	1.406 35.71	1.100 27.94	1-1658525-0	622-2453LF
26	1.506 38.25	1.200 30.48	1658525-1	622-2653LF
34	1.906 48.41	1.600 40.64	1658525-2	622-3453LF
36	2.006 50.95	1.700 43.18	1-1658525-2	622-3653LF
40	2.206 56.03	1.900 48.26	1-1658525-3	622-4053LF
50	2.706 68.73	2.400 60.96	1658525-3	622-5053LF
60	3.206 81.43	2.900 73.66	1-1658525-5	622-6053LF
64	3.406 86.51	3.100 78.74	1-1658525-6	622-6453LF

**Notes:** Order by TE Part Number only.  
All part numbers are RoHS compliant.

050 [1 27] Centerline Ribbon Cable Connectors  
DIP Plugs, .100 x .100 [2.54 x 2.54] Centers, 622 Series

## DIP Plugs, .100 x .100 [2.54 x 2.54] Centers

### Housing Assembly with Cover (Preassembled)

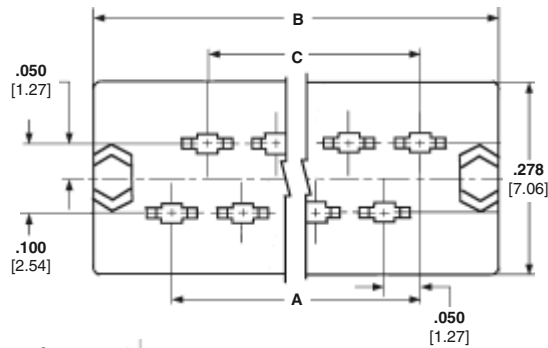
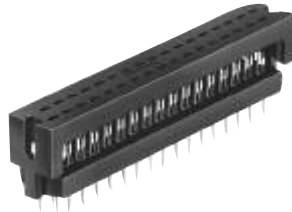

### Material and Finish

**Housing and Cover** — Black thermoplastic, UL 94V-0 rated

**Contacts** — Phosphor bronze, plated .000005 [0.000127] min. gold in termination area, .000100 [0.00254] min. tin on solder tails, both over .000050 [0.00127] nickel on entire contact

**Contact Design** — Flat, tuning fork style IDC

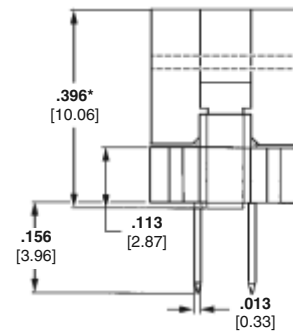
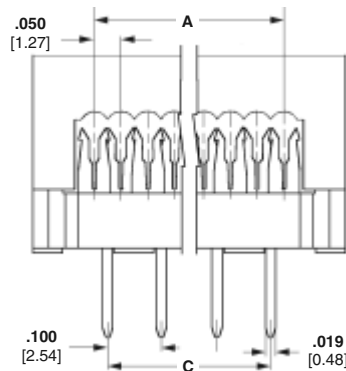

\*Height of connector after termination is .253 [6.43] ref.

### Related Product Data

**Application Tooling** — pages 70-74

### Technical Documents

#### Product Specification

108-1538 DIP Plug

#### Instruction Sheets

Instructional material covering operation, setup, maintenance, repair, etc. is included with each machine, tool or die set. If this material is required prior to receiving your tooling, call TE at the numbers listed below for the applicable documents.

**Mateable Connectors** —  
**For Connectors without Retention Legs** — .100 x .100 DIP Sockets

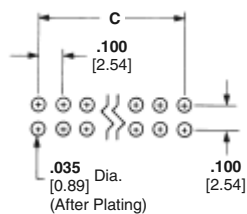
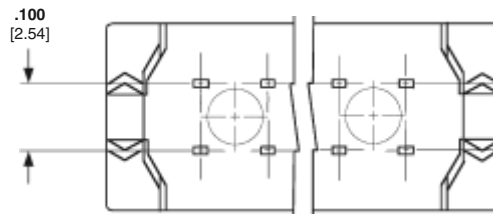

PCB Layout

No. of Pos.	Dimensions			DIP Plugs (Preassembled)	With Retention Legs
	A	B	C		
10	.450 11.43	.680 17.27	.400 10.16	2-746610-1	1-111382-4
14	.650 16.51	.880 22.35	.600 15.24	2-746610-2	—
16	.750 19.05	.980 24.89	.700 17.78	1-746610-4	1-111382-6
20	.950 24.13	1.180 29.97	.900 22.86	1-746610-5	1-111382-7
24	1.150 29.21	1.380 35.05	1.100 27.94	2-746610-3	—
26	1.250 31.75	1.480 37.59	1.200 30.48	1-746610-6	1-111382-8
30	1.450 36.83	1.680 42.67	1.400 35.56	1-746610-7	—
34	1.650 41.91	1.880 47.75	1.600 40.64	1-746610-8	1-111382-9
40	1.950 49.53	2.180 55.37	1.900 48.26	1-746610-9	—
44	2.150 54.61	2.380 60.45	2.100 53.34	2-746610-6	—
50	2.450 62.23	2.680 68.07	2.400 60.96	2-746610-0	2-111382-0
60	2.950 74.93	3.180 80.77	2.900 73.66	2-746610-4	—
64	3.150 80.01	3.380 85.85	3.100 78.74	2-746610-5	—

**Notes:** All plug kits include a housing assembly and cover (preassembled).  
All part numbers are RoHS compliant.

## DIP Plugs, .100 x .300 [2.54 x 7.62] Centers

### Housing Assembly with Cover (Preassembled)

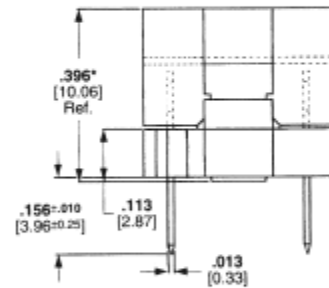
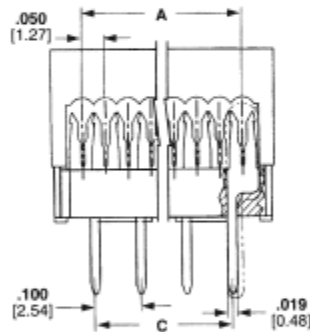
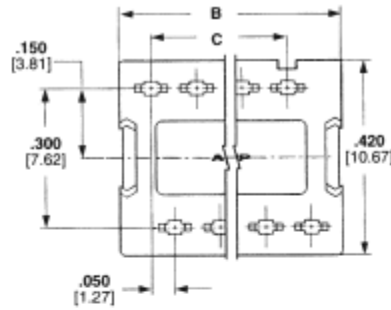
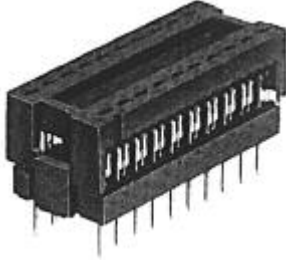

\*Height of connector after termination is .253 [6.43] ref.

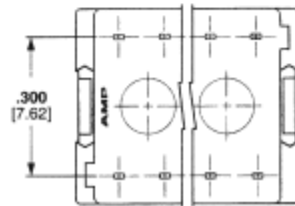

### Material and Finish

**Housing and Cover** — Black thermoplastic, UL 94V-0 rated

**Contacts** — Phosphor bronze, plated .000050 [0.00127] nickel underplate on entire contact, .000005 [0.000127] min. gold on termination (IDC) end. See table for leg finish.

**Contact Design** — Flat, tuning fork style IDC

### Related Product Data

**Application Tooling** — pages 70-74

### Technical Documents

#### Product Specification

108-1538 DIP Plug

#### Ribbon Cable Requirements

28 AWG stranded or 26, 28 and 30 AWG solid wire

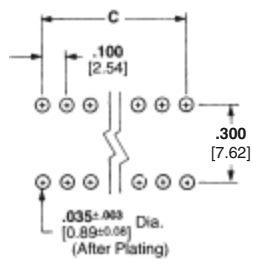

**Recommended Mounting Hole Pattern**  
(for .094-.125 [2.39-3.18] thick pc boards)

No. of Pos.	Dimensions			Contact Plating	DIP Plugs (Preassembled)
	A	B	C		
8	.350	.488	.300	Duplex <sup>1</sup>	746611-7
	8.89	12.40	7.62	Duplex <sup>2</sup>	—
				Duplex <sup>3</sup>	5746613-1
14	.650	.788	.600	Duplex <sup>1</sup>	746611-8
	16.51	20.02	15.24	Duplex <sup>2</sup>	5746612-2
				Duplex <sup>3</sup>	5746613-2
16	.750	.888	.700	Duplex <sup>1</sup>	746611-6
	19.05	22.56	17.78	Duplex <sup>2</sup>	5746612-3
				Duplex <sup>3</sup>	5746613-3
18	.850	.988	.800	Duplex <sup>1</sup>	746611-9
	21.59	25.10	20.32	Duplex <sup>2</sup>	—
				Duplex <sup>3</sup>	—
20	.950	1.088	.900	Duplex <sup>1</sup>	1-746611-0
	24.13	27.64	22.86	Duplex <sup>2</sup>	—
				Duplex <sup>3</sup>	—

<sup>1</sup> .000030 [0.00076] gold on leg

<sup>2</sup> .000015 [0.00038] gold on leg

<sup>3</sup> .000100 [0.00254] tin on leg

**Note:** All part numbers are RoHS compliant.



## DIP Plugs, .100 x .600 [2.54 x 15.24] Centers

### Housing Assembly with Cover (Preassembled)

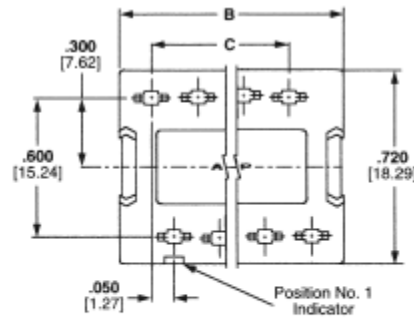
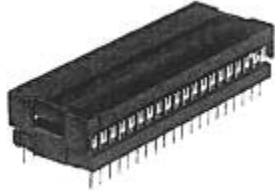

### Material and Finish

**Housing and Cover** — Black thermo-plastic, UL 94V-0 rated

**Contacts** — Phosphor bronze, plated .000050 [0.00127] nickel underplate on entire contact, .000005 [0.000127] min. gold on termination (IDC) end. See table for leg finish.

**Contact Design** — Flat, tuning fork style IDC

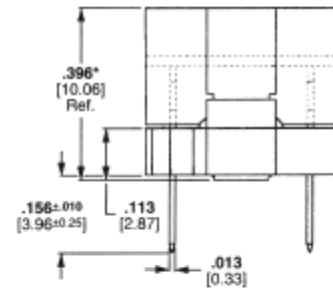
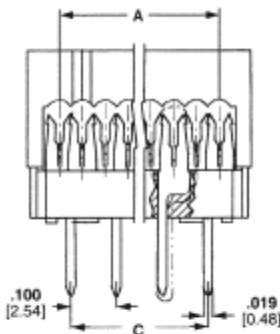

\*Height of connector after termination is .253 [6.43] ref.

### Related Product Data

**Application Tooling** — pages 70-74

### Technical Documents

#### Product Specification

108-1538 DIP Plug

#### Ribbon Cable Requirements —

28 AWG stranded or 26, 28 and 30 AWG solid wire

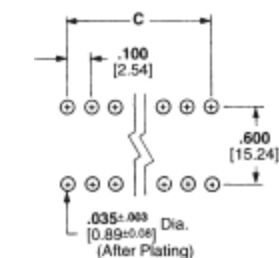
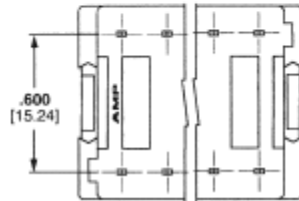

### Recommended Mounting

**Hole Pattern**  
(for .094-.125 [2.39-3.18] thick pc boards)

No. of Pos.	Dimensions			Contact Plating	DIP Plugs (Preassembled)
	A	B	C		
24	1.150 29.21	1.288 32.72	1.100 27.94	Duplex <sup>1</sup>	5746615-1
28	1.350 34.29	1.488 37.80	1.300 33.02	Duplex <sup>1</sup>	5746615-2
40	1.950 49.53	2.088 53.04	1.900 48.26	Duplex <sup>1</sup>	5746615-3

<sup>1</sup> .000015 [0.00038] gold on leg

**Note:** All part numbers are RoHS compliant.

.050 [1.27] Centerline Ribbon Cable Connectors  
DIP Plugs, .100 x .600 [2.54 x 15.24] Centers

## 4-Row PCB Solder Transition Connectors

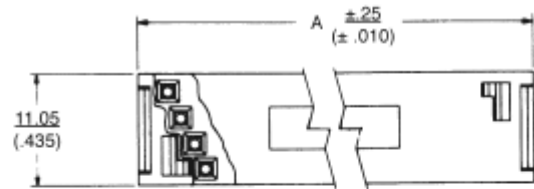

### Technical Data

**Color** — Blue

**Contact Material** — Beryllium copper

**Contact Plating** — .000100-.000200 [0.00254-0.00508] tin over .000050 [0.00127] nickel underplate.

**Contact Design** — Dual slot, barrel shaped (“tulip”) IDC with solder tail

**Housing Material** — Glass-filled thermoplastic, UL 94V-0 rated

**Cable** — 28-30 AWG solid or stranded, PVC insulated ribbon cable

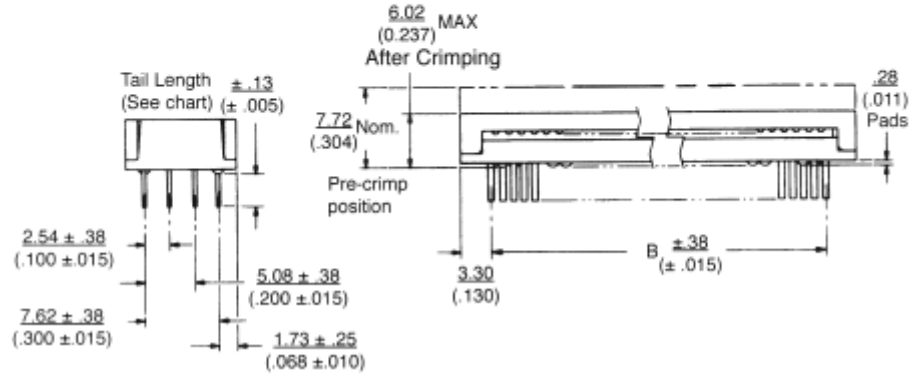

### Application Tooling

**Die** —

1-1437000-3 [T&B# 779-2153 ref]

**Handtool** —

1437000-6 [T&B# 779-2100 ref]

**Bench Press (Manual)** —

1437001-4 [T&B# 779-3200 ref]

**Bench Press Platen** —

5-1437000-6 [T&B# 779-3130 ref]

**Bench Press Base Plate** —

6-1437000-7 [T&B# 779-3153 ref]

### 609 Series, Military Polarized

No. of Pos.	Dimensions A B		Part Numbers			
			.100 Tail Length		.156 Tail Length	
			TE Connectivity	T&B (Reference Only)	TE Connectivity	T&B (Reference Only)
10	.710 18.03	.450 11.43	6437006-5	609-1003LF	—	—
14	.910 23.11	.650 16.51	6437006-8	609-1403LF	6437006-9	609-1443LF
16	1.010 25.65	.750 19.05	1-6437006-1	609-1603LF	—	—
20	1.210 30.73	.950 24.13	—	—	1-6437006-5	609-2043LF
26	1.510 38.35	1.250 31.75	1-6437006-8	609-2603LF	2-6437006-0	609-2643LF
34	1.910 48.51	1.650 41.91	2-6437006-2	609-3403LF	2-6437006-3	609-3443LF
44	2.410 61.21	2.150 54.61	2-6437006-9	609-4403LF	—	—
50	2.710 68.83	2.450 62.23	—	—	3-6437006-2	609-5043LF

**Notes:** Order by TE Part Number only.  
All part numbers listed above are found on TE Customer Drawing 6437006-5.

**Note:** All part numbers are RoHS compliant.

## 1-Row Horizontal Receptacles



### Material and Finish

**Housing** — Black PPS, UL 94V-0 rated

**Contacts** — Phosphor bronze, post tin plated over nickel underplate

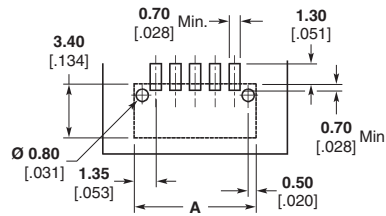
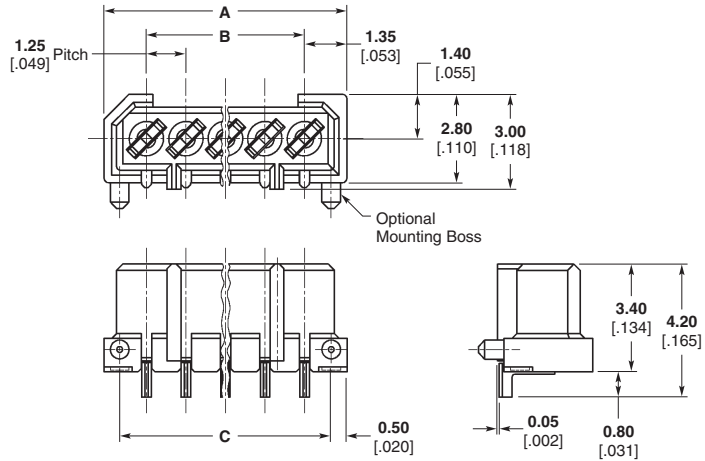

PCB Mounting Layout

### 1.25 Fine Pitch (FP) - 1-Row Horizontal Receptacles

No. of Pos.	Dimensions			Part Numbers			
	A	B	C	With Mounting Bosses		Without Mounting Bosses	
				Tape	Bag	Tape	Bag
4	6.45 .254	3.75 .148	5.45 .215	3-175637-4	3-174638-4	3-175629-4	3-174903-4
5	7.70 .303	5.00 .197	6.70 .264	3-175637-5	3-174638-5	3-175629-5	3-174903-5
6	8.95 .352	6.25 .246	7.95 .313	3-175637-6	3-174638-6	3-175629-6	3-174903-6
7	10.20 .402	7.50 .295	9.20 .362	3-175637-7	3-174638-7	3-175629-7	3-174903-7
8	11.45 .451	8.75 .345	10.45 .411	3-175637-8	3-174638-8	3-175629-8	3-174903-8
10	13.95 .549	11.25 .443	12.95 .510	4-175637-0	4-174638-0	4-175629-0	4-174903-0
17	22.70 .894	20.00 .787	21.70 .854	—	4-174638-7	4-175629-7	4-174903-7
20	26.45 1.041	23.75 .935	25.45 1.002	—	5-174638-0	—	5-174903-0

**Note:** All part numbers are RoHS compliant.

## Accessories

### Flexible Pull Tabs

#### Material and Finish

Nylon, black

#### Part Number 120623-1

#### Related Product Data

**Novo Connectors** — pages 48-51

**Ultra ATA Bus Connectors** — pages 13-15

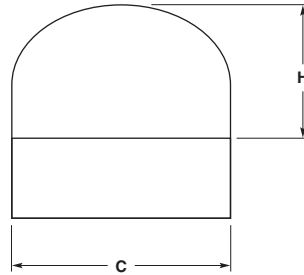
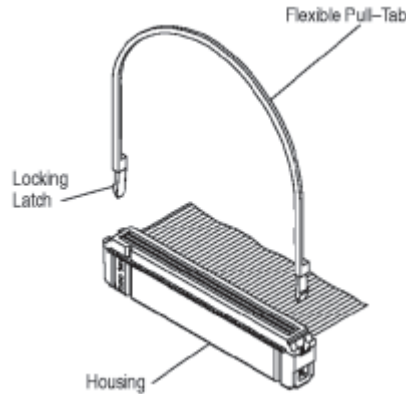

#### Approximate Installed Height of Part Number 120623-1 Above Connector

No. of Positions	Dimensions	
	C	H
10	.680	1.806
	17.27	45.87
14	.880	1.749
	22.35	44.42
16	.980	1.721
	24.89	43.71
20	1.180	1.664
	29.97	42.27
24	1.380	1.607
	35.05	40.82
26	1.480	1.578
	37.59	40.08
30	1.680	1.521
	42.67	38.63
34	1.880	1.464
	47.75	37.19
36	1.980	1.436
	50.29	36.47
40	2.180	1.379
	55.37	35.03
44	2.380	1.322
	60.45	33.58
50	2.680	1.236
	68.07	31.39
60	3.180	1.094
	80.77	27.79
64	3.380	1.037
	85.85	26.34

**Note:** Cannot be used together with a strain relief.

### Universal I/O Latches

#### Material and Finish

Polyester, black

#### Related Product Data

**Universal I/O Pin Connectors** — pages 45 and 46

**Latch Removal Tool**  
Part Number 91269-1

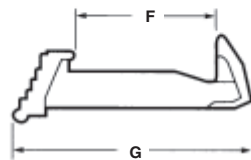
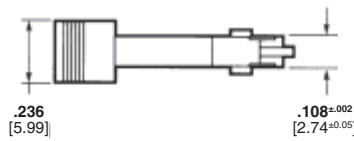

Mates to Receptacles	Dimensions		Part Number
	F	G	
Without Strain Relief	.416	.768	111451-1
	10.57	19.51	
With Strain Relief	.576	.928	111451-3
	14.63	23.57	

### Military Polarizers

#### Material and Finish

Thermoplastic, black

#### Related Product Data

**Universal I/O Pin Connectors** — pages 45 and 46

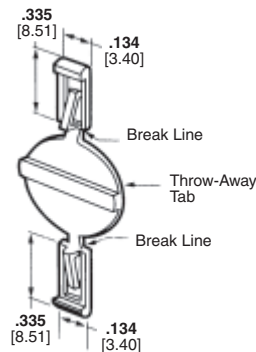

#### Part Numbers:

**499991-2** (packaged, 50 per bag)

**499991-3** (packaged, 1000 per box)

The snap-in polarizer provides military polarization.

**Note:** All part numbers are RoHS compliant.

**Accessories** (Continued)

**Keying Plugs**

**Material and Finish**

Thermoplastic, see table for color

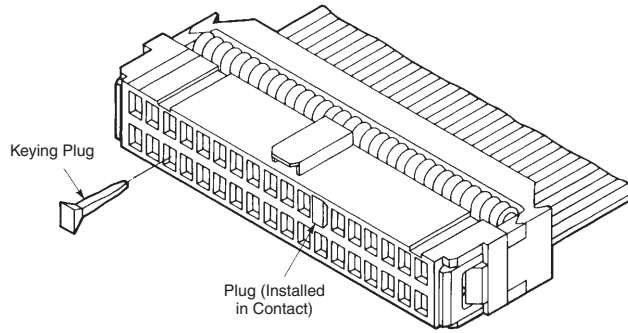

Typical Application

**Key Plug 111620-1**

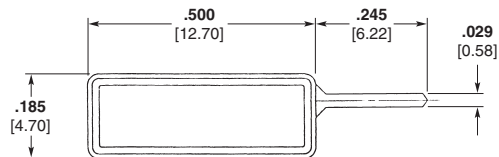
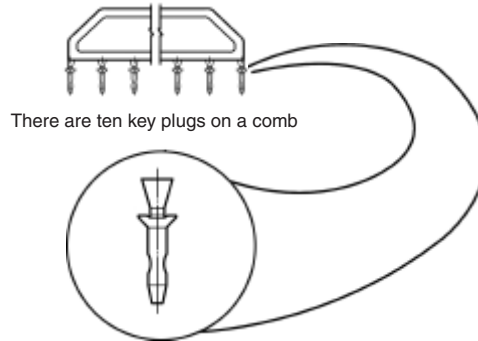

**Polarizing Key**  
1-1437023-2

Receptacle Connector Series	Catalog Pages	Keying Plug Part Number	Style	Color
2 mm Rcpt. Connectors	16, 17	111620-1	Comb	Black
609 Series Female Socket Connectors	54, 55	1-1437023-2 T&B 609-0000 (Ref.)	Single	Blue
622 Series Female Socket Connectors	52, 53	1-1437023-2 T&B 609-0000 (Ref.)	Single	Blue
636 Series Female Socket Connectors	52, 53	1-1437023-2 T&B 609-0000 (Ref.)	Single	Blue

Order by TE Part Number only.

**Note:** All part numbers are RoHS compliant.

**Accessories** (Continued)

**Keying Plugs** (Continued)

**Material and Finish**

Thermoplastic, see table for color

**Part Number 499712-1**



**Key Plug**  
(Plugs into Contact)

Receptacle Connector Series	Catalog Pages	Keying Plug Part Number	Style	Color
Novo Connectors	48-51	499712-1	Single	Black
		104072-1	Comb	
Ultra ATA Bus Connectors	13-15	499712-1	Single	Black
		104072-1	Comb	

Order by TE Part Number only.

**Alternate Configuration**  
**Keying Plug Part No. 104072-1**  
**(10 Keying Plugs per Comb)**

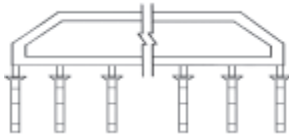

**Note:** All part numbers are RoHS compliant.



**Accessories** (Continued)

**Pull Loops, Permanent (for Receptacles and Pin Connectors)**

**Material and Finish**

Natural color PVC, 94-VTM-1 rating (thin material)

**Related Product Data**

**Use with:**

**Female Socket Connectors** — pages 52-55

**Ultra ATA Bus Connectors** — pages 13-15

**2 mm Receptacle Connectors** — pages 16 and 17

**Novo Connectors** — pages 48-51

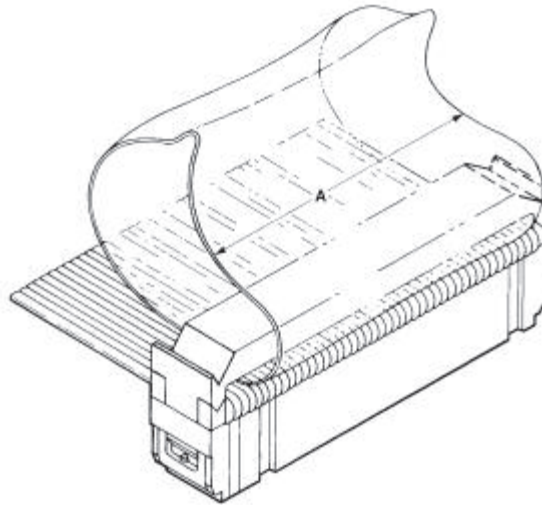

**Note:** This pull loop is installed manually between the cover and strain relief, and cannot be used without strain relief.

Female Socket Conns.	No. of Positions			Dimension A	Pull Loop Part No.
	Ultra ATA Bus Conns.	2 mm Rcpt. Conns.	Novo Conns.		
10	—	12, 14, 16	10	.44 11.18	5088450-2
14	—	20	14	.64 16.26	5088450-3
16	—	22	16	.74 18.80	5088450-4
20	—	24, 26	20	.88 22.35	5088450-5
24	—	—	24	1.08 27.43	5088450-6
26	—	30, 34, 40	26	1.18 29.97	5088450-7
30	—	—	30	1.38 35.05	1-5088450-2
34	—	44	34	1.58 40.13	5088450-8
40	40	50	40	1.82 46.23	5088450-9
50	—	—	50	2.32 58.93	1-5088450-0
60	—	—	60	2.80 71.12	1-5088450-1

**Note:** All part numbers are RoHS compliant.

### Accessories (Continued)

#### Strain Relief for Universal I/O Pin Connectors Without Mounting Ears

##### Material and Finish

Glass-filled polyester, black

##### Related Product Data

Universal I/O Pin Connectors — page 45

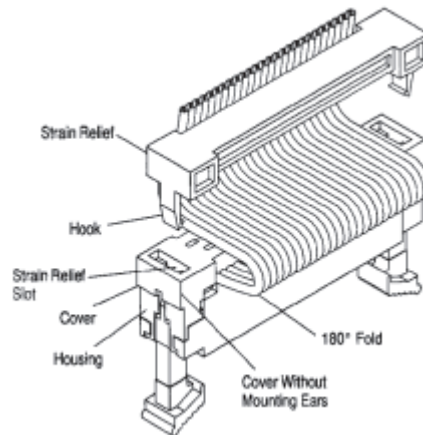
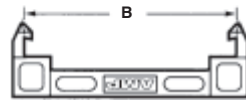
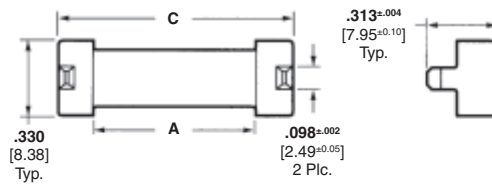

No. of Pos.	Dimensions			Part Number
	A	B	C	
10	.520 13.21	.766 19.46	.940 23.88	111547-1
14	.720 18.29	.966 24.54	1.140 28.96	111547-2
16	.820 20.83	1.066 27.08	1.240 31.50	111547-3
20	1.020 25.91	1.266 32.16	1.440 36.58	111547-4
24	1.220 30.99	1.466 37.24	1.640 41.66	111547-5
26	1.320 33.53	1.566 39.78	1.740 44.20	111547-6
30	1.520 38.61	1.766 44.86	1.940 49.28	111547-7
34	1.720 43.69	1.966 49.94	2.140 54.36	111547-8
40	2.020 51.31	2.266 57.56	2.440 61.98	111547-9
44	2.220 56.39	2.466 62.64	2.640 67.06	1-111547-0
50	2.520 64.01	2.766 70.26	2.940 74.68	1-111547-1
60	3.020 76.71	3.266 82.96	3.440 87.38	1-111547-2
64	3.220 81.79	3.466 88.04	3.640 92.56	1-111547-3

#### Strain Relief for 609 Series (Tulip Contact) Female Socket Connectors

##### Material and Finish

Glass-filled polyester, blue

##### Related Product Data

Female Socket Connectors — page 54 and 55

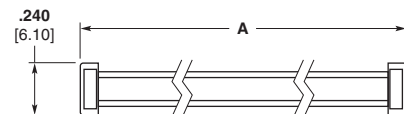

Standard Version

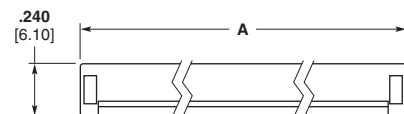

Heavy Duty Version

No. of Pos.	Dimension A	Type	Part Number	
			TE Connectivity	T&B (Ref. Only)
6	.472 11.99	Standard	2-1437020-1	609-0631
10	.672 17.07	Heavy Duty	3-1437020-7	609-1031HD
		Standard	3-1437020-5	609-1031
14	.872 22.15	Heavy Duty	5-1437020-1	609-1431HD
		Standard	4-1437020-9	609-1431
16	.972 24.69	Heavy Duty	6-1437020-6	609-1631HD
		Standard	6-1437020-4	609-1631
20	1.172 29.77	Heavy Duty	8-1437020-6	609-2031HD
		Standard	8-1437020-4	609-2031
24	1.372 34.85	Standard	9-1437020-4	609-2431
26	1.472 37.39	Heavy Duty	1-1437021-2	609-2631HD
		Standard	1-1437021-0	609-2631
34	1.872 47.55	Heavy Duty	3-1437021-2	609-3431HD
		Standard	3-1437021-0	609-3431
40	2.172 55.17	Heavy Duty	5-1437021-5	609-4031HD
		Standard	5-1437021-3	609-4031
50	2.672 67.87	Heavy Duty	8-1437021-1	609-5031HD
		Standard	7-1437021-9	609-5031
64	3.372 85.65	Heavy Duty	1-1437022-3	609-6431HD

**Note:** Heavy duty part numbers are listed on TE customer drawing 3-1437020-7. Standard part numbers are listed on TE customer drawing 2-1437020-1.

All part numbers are RoHS compliant.

**Accessories** (Continued)

**Strain Relief for Novo and Ultra ATA Bus Connectors**

**Material and Finish**

Glass-filled polyester, black

**Related Product Data**

**Novo Connectors** — pages 48-51

**Ultra ATA Bus Connectors** — pages 13-15

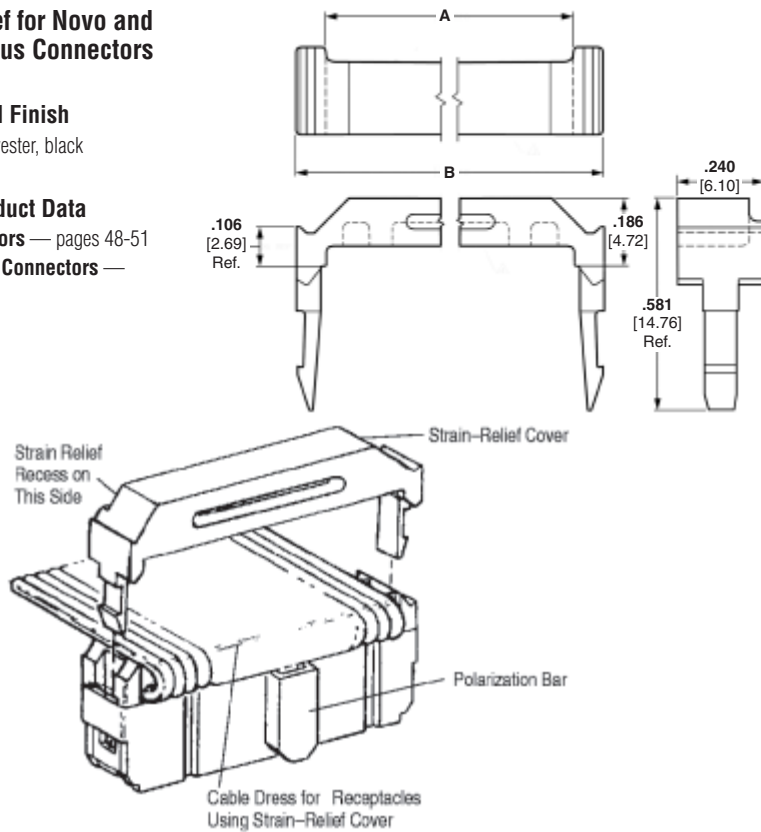

No. of Pos.	Dimensions		Part Number
	A	B	
10	.534 13.56	.690 17.53	499252-5
14	.734 18.64	.890 22.61	499252-9
16	.834 21.18	.990 25.15	499252-8
20	1.034 26.26	1.190 30.23	499252-2
24	1.234 31.34	1.390 35.31	1-499252-0
26	1.334 33.88	1.490 37.85	499252-3
30	1.534 38.96	1.690 42.93	1-499252-2
34	1.734 44.04	1.890 48.01	499252-6
40	2.034 51.66	2.190 55.63	499252-1*
44	2.234 56.74	2.390 60.71	1-499252-1
50	2.534 64.36	2.690 68.33	499252-4
60	3.034 77.06	3.190 81.03	499252-7
64	3.234 82.14	3.390 86.11	1-499252-3

\*Ultra ATA Strain Relief is 499252-1 only.

Accessories

**Strain Relief for 2 mm Receptacle Connectors**

**Material and Finish**

Glass-filled polyester, black

**Related Product Data**

**2 mm Receptacle Connectors** — pages 16 and 17

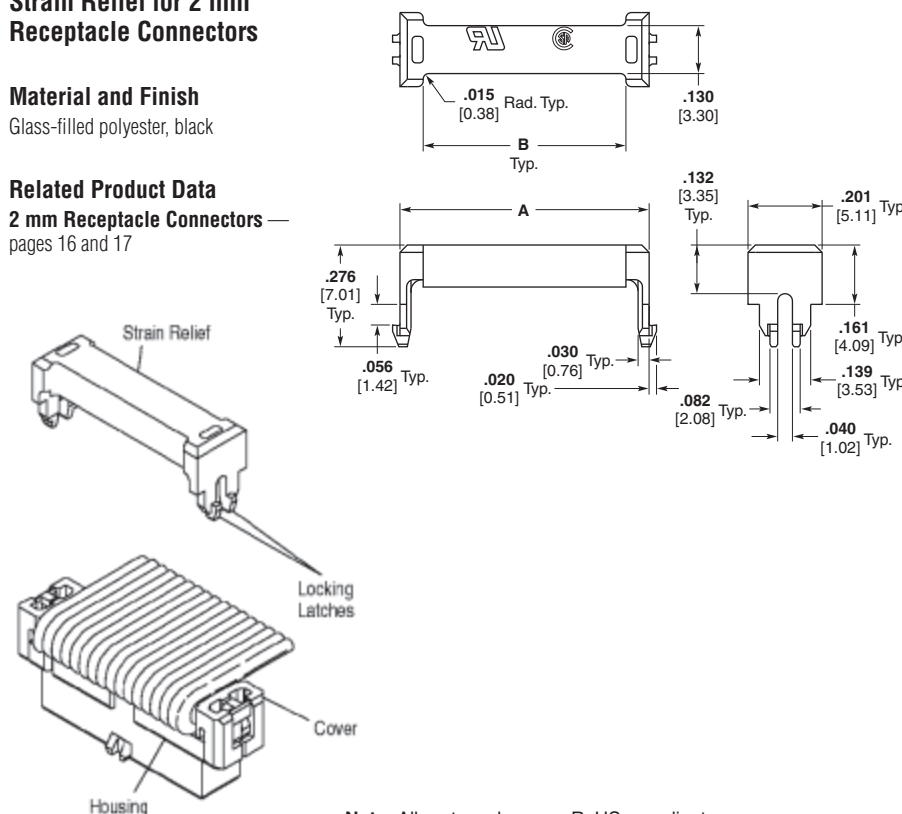

No. of Pos.	Dimensions		Part Number
	A	B	
8	.440 11.18	.314 7.98	1-111614-6
10	.518 13.16	.392 9.96	111614-1
12	.596 15.14	.470 11.94	1-111614-7
14	.676 17.17	.550 13.97	111614-2
16	.755 19.18	.629 15.98	111614-3
20	.912 23.16	.786 19.96	111614-4
22	.991 25.17	.865 21.97	1-111614-5
24	1.070 27.18	.944 23.98	111614-5
26	1.148 29.16	1.022 25.96	111614-6
30	1.306 33.17	1.180 29.97	111614-7
34	1.463 37.16	1.337 33.96	111614-8
40	1.700 43.18	1.574 39.98	111614-9
44	1.857 47.17	1.731 43.97	1-111614-0
50	2.093 53.16	1.967 49.96	1-111614-1

**Note:** All part numbers are RoHS compliant.

**Accessories** (Continued)

**Strain Relief for 622 and 636 Series Female Socket Connectors**

**Material and Finish**

Glass-filled PBT, see table for color

**Related Product Data**

**Female Socket Connectors** —  
pages 52 and 53

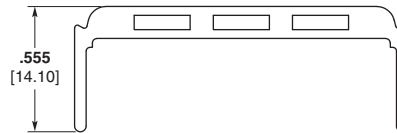
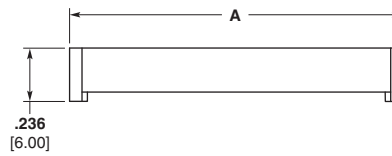

No. of Pos.	Dimension C	Color	Part Number	
			TE Connectivity	T&B (Ref. Only)
6	.477 12.12	Blue	2-1437023-9	622-0631
		Black	1-1437026-9	636-0631
10	.677 17.20	Blue	4-1437023-7	622-1031
		Black	3-1437026-9	636-1031
14	.877 22.28	Blue	7-1437023-1	622-1431
		Black	6-1437026-6	636-1431
16	.977 24.82	Blue	8-1437023-9	622-1631
		Black	8-1437026-5	636-1631
20	1.177 29.90	Blue	1437024-5	622-2031
		Black	1437027-7	636-2031
24	1.377 34.98	Blue	1-1437024-6	622-2431
		Black	5-1437011-3	636-2431
26	1.477 37.52	Blue	2-1437024-8	622-2631
		Black	3-1437027-4	636-2631
30	1.677 42.60	Blue	4-1437024-0	622-3031
		Black	6-1437011-6	636-3031
34	1.877 47.68	Blue	5-1437024-3	622-3431
		Black	8-1437027-0	636-3431
40	2.177 55.30	Blue	8-1437024-3	622-4031
		Black	3-1437028-4	636-4031
50	2.677 68.00	Blue	1-1437025-2	622-5031
		Black	6-1437028-8	636-5031
60	3.177 80.70	Black	9-1437028-5	636-6031
64	3.377 85.78	Blue	4-1437025-0	622-6431
		Black	1437029-2	636-6431

**Note:** These part numbers are listed on TE customer drawing 1-1437026-9.

**Note:** All part numbers are RoHS compliant.

## Ribbon Cable Assembly Machines (R-CAM)

### Product Facts

- Terminates 28 AWG [0.08 mm<sup>2</sup>] .050 [1.27] centerline and 30 AWG [0.05 mm<sup>2</sup>] .025 [0.64] centerline cable to a variety of connectors
- Automatic in-process electrical testing — tests all circuits for opens, shorts and high-voltage breakdown (up to 1,000 volts for receptacles, 800 volts for card edge connectors and 300 volts for .025 [0.64] centerline connectors); rejects cable assemblies failing any of these tests
- Operated by a user-friendly, interactive touchscreen — or a keyboard on the R-CAM 4
- Self-diagnostics shut down the machine when a malfunction occurs, pinpoint the malfunction, and identify it on the screen
- Produced under a Quality Management System certified to ISO 9001

A copy of the certificate is available upon request.



The R-CAM 4, pictured above, is the newest fully automatic Ribbon Cable Assembly Machine for producing and testing daisy-chained ribbon cable assemblies. Enhancements of this model include the capability to process pre-manufactured slit-and-twist cable and the ability to produce assemblies with up to 10 connectors.

The R-CAM 2A, 3A, and 4 terminate 28 AWG [0.08 mm<sup>2</sup>], .050 [1.27] centerline cable to a variety of connectors. The R-CAM 4 will also terminate 30 AWG [0.05 mm<sup>2</sup>] .025 [0.64] centerline cable.

All of the R-CAM models automatically perform an in-process electrical test of all circuits for opens and shorts. In addition, all models automatically test the assembly for high-voltage breakdown up to 1,000 volts, depending on the

machine and connector style. The purpose of this test is to detect gaps that may have been created during assembly that could eventually short out when in use. If an assembly fails any of these tests, the machine will shear the cable off at that point and automatically discard it into an alternate bin.

These machines are programmed and operated with an interactive touchscreen that allows operators to access manual, set-up, run, and edit modes through easy-to-follow menu-driven prompts.

Self-diagnostics shut down the machine if a malfunction — such as misloaded connectors or incorrectly fed cable — is detected, pinpoint the malfunction, and identify it on the touchscreen.

Models 2A and 3A are available in 120 or 220 VAC, 8 A,

50 or 60 Hz. Model 4 operates at 120 or 220 VAC, 50-60 Hz, single phase, 15A.

The R-CAM 2A and 3A require a minimum air supply of 80 psi [5.52 bar] at 8 scfm [0.0038m<sup>3</sup>/s]. The R-CAM 4 requires 80 psi [5.52 bar] at 12 scfm [0.0057 m<sup>3</sup>/s].

### Need more information?

For more information, specifically about tooling, call TE at the numbers listed below.

## Comparison of R-CAM 2A, R-CAM 3A and R-CAM 4



Machine Model	R-CAM 2A	R-CAM 3A	R-CAM 4
<b>Part Number*</b>	<b>760700-□</b>	<b>761900-□</b>	<b>318800-□</b>
<b>Cable Size</b>	28 AWG [0.08 mm <sup>2</sup> ], .050 [1.27] centerline	28 AWG [0.08 mm <sup>2</sup> ], .050 [1.27] centerline	28 AWG [0.08 mm <sup>2</sup> ], .050 [1.27] centerline and 30 AWG [0.05 mm <sup>2</sup> ], .025 [0.64] centerline
<b>Cable Assembly Configurations</b> (Refer to page 73)	Maximum cable length of 48 [1 220]	Maximum cable length of 105 [2 665]	Maximum cable length of 100 [2 540]
	Produces one- to four-connector assemblies with unterminated tail lengths up to 12 [305]	Produces one- or two-connector assemblies with unterminated tail lengths up to 24 [610]	Produces one- to 10-connector assemblies with unterminated tail lengths up to 24 [610]
	Trailing connectors can be oriented up or down	Trailing connectors can be oriented up or down	Trailing connectors can be oriented up or down
	—	—	Automatically processes and tests assemblies produced with pre-manufactured slit-and-twist cable
<b>Production Rates</b> (Refer to page 72)	Depending on cable lengths, can apply and test up to 1 670 connectors per hour	Depending on cable lengths, can apply and test up to 2 000 connectors per hour	Depending on cable lengths, can apply and test up to 1 050 connectors per hour
<b>Size</b>	108 [2 745] W x 54 [1 370] D x 60 [1 525] H; 750 lb [340 kg]	48 [1 220] W x 48 [1 220] D x 62 [1 575] H; 630 lb [286 kg]	68 [1 730] W x 58 [1 475] D x 72 [1 830] H; 1 300 lb [590 kg]
<b>Programmable</b>	Operated and programmed by a touchscreen	Operated and programmed by a touchscreen	Operated and programmed by a touchscreen or a keyboard
	Parameters for up to 130 cable assemblies can be retained in memory	Parameters for up to 150 cable assemblies can be retained in memory	Parameters for up to 1 000 cable assemblies can be retained in memory
	Another menu displays production totals or a log of the machine events	Another menu displays production totals or a log of the machine events	—
<b>Testing</b>	Automatically stops after each or three consecutive assemblies are rejected, as programmed by the operator	Automatically stops when either a consecutive number of assemblies or a percentage of the batch run are rejected, as programmed by the operator	Automatically stops each time a malfunction is detected
<b>Changeover</b>	Requires an average of 25 minutes, depending on assembly size	Requires an average of 15 minutes, depending on assembly size	Requires an average of 20 minutes to 1 hour, depending on assembly size and type

\*Note: Machine may require accessories. Before ordering, contact TE at the numbers listed below.



### Typical Production Rates (Assemblies/Hour)

Machine Model	Connectors Per Assembly	Length				
		4 [100]	8 [205]	24 [160]	48 [1 220]	100 [2 540]
R-CAM 2A	1	665	620	—	—	—
	2	570	500	405	300	—
	3	475	460	375	280	—
	4	—	420	360	255	—
R-CAM 3A	2	1 075	950	780	660	500
	4	—	275	265	255	—
R-CAM 4	5	—	205	200	190	—
	6	—	170	165	160	—
	10	—	—	—	115	105

**Note:** Actual production rates may vary depending on the cable assembly configuration.

### Available Tooling

**Note:** Call TE at the numbers listed below for part numbers or availability.

Tooling for Connectors	Number of Positions		
	R-CAM 2A	R-CAM 3A	R-CAM 4 <sup>**</sup>
Ultra Novo Receptacles	—	—	40
AMPLIMITE .050 Series Connectors	—	—	68
AMPLIMITE HDF-20 D-Sub.	Plugs Receptacles	15, 25, 37	9, 15, 25, 37
.100 x .100 DIP Plugs	One End Only, 20–64	One End Only, 10–64	Available in future
Card Edge Connectors*	20–64	10–64	20–50 (10–64 Available in future)
Novo Receptacles*	20–64	10–64	10–64
2 mm Receptacles	—	12–50	—
Universal I/O Pin Connectors	One End Only, 20–64	—	Trail Module Only

\* Supplied with the R-CAM 2A and R-CAM 3A only.

<sup>†</sup> Reel fed version.

<sup>\*\*</sup> Order Connector Specific Tooling Packages / Feed Shear Tooling separately.

### Products Applied



AMPLIMITE HDF-20 D-Sub. Plugs



AMPLIMITE HDF-20 D-Sub. Receptacles



.100 x .100 DIP Plugs



Card Edge Connectors



Novo Receptacles



2 mm Receptacles

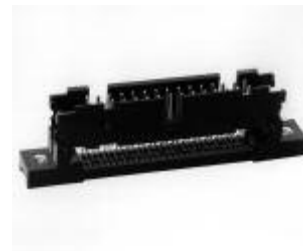

Universal I/O Pin Connectors



Pre-manufactured Slit-and-Twist Cable  
(R-CAM 4 only)

**Note:** For more product information, call TE at the numbers listed below.

## Cable Assembly Configurations

### R-CAM 2A

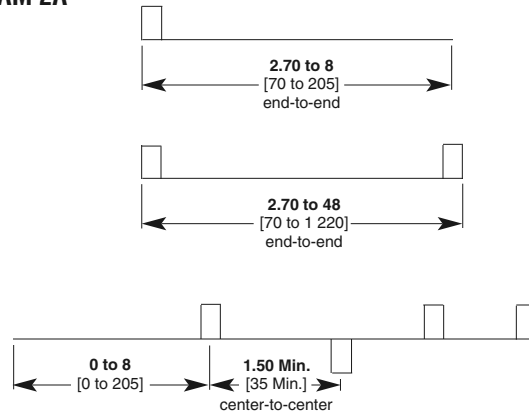

### R-CAM 3A

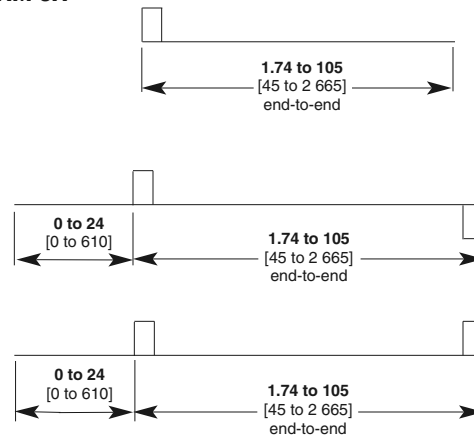

### R-CAM 4

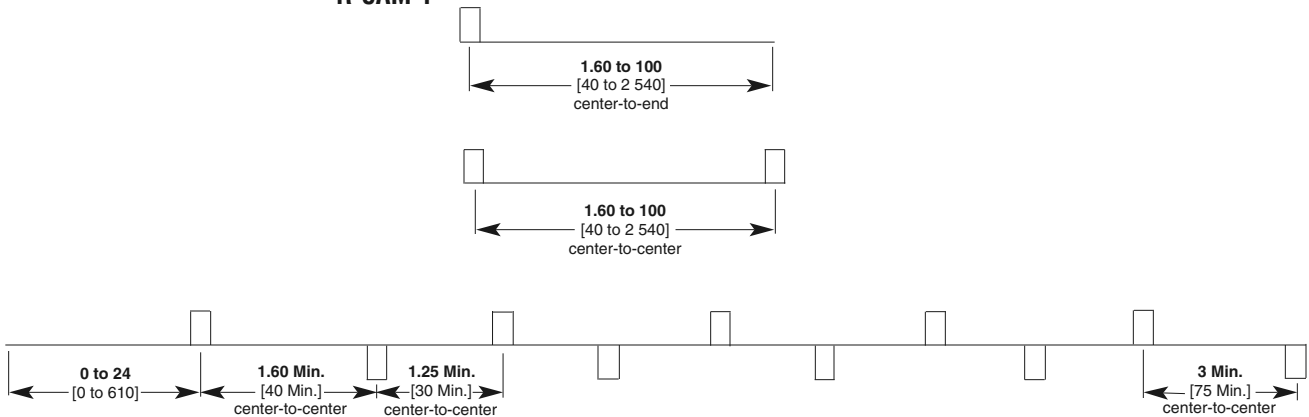

## Application Tooling



### Manual Arbor Frame Assembly, Part No. 91085-2

Bench frame for applying a variety of IDC connectors, including AMPMODU MT and CHAMP. Features adjustable ram and handle, and a slide base. Tooling is mounted to the ram and into the tracks of the base plate.



### Hand Tool Kit—Part No. 768340-1

Terminating kit for .050 [1.27] centerline ribbon cable with 28 or 26 AWG [0.08 or 0.15 mm<sup>2</sup>] stranded or solid, or 30 AWG [0.05 mm<sup>2</sup>] solid conductors. Includes commercial grade hand tool with ratchet control for complete termination cycle, base assembly, bench-mount, tooling sets for standard and Novo receptacles, card edge connectors and D-Sub HDF low-profile connectors, and a carrying case.



### Pneumatic Auto-Cycle Unit, Part No. 91112-3

Basically an air-powered version of Manual Arbor Frame Assembly 91085-2. Features adjustable ram and cycle time, and automatic cycling when the lower assembly is slid into the frame to the rear of the base plate. Includes a guard around the frame opening.

### Tooling Instruction Sheets

**408-7777**—Manual Arbor Frame Assembly

**408-6732**—Pneumatic Auto-Cycle Assembly



**408-9828**—Hand Tool Kit 768340-1 for Connector-Specific Kits

### Pneumatic Foot Pedal Unit Part No. 91112-2

Foot pedal indicates cycle—features adjustable ram and cycle time.

## Low Profile Headers

### Product Facts

- Available in selected positions 10 thru 60
- Flame retardant, thermoplastic housings, 94V-0 rated
- Vertical and right-angle versions available in double row configurations
- Available in .025 [0.64] square drawn wire posts
- Wash out clearance for flux removal
- Mates with Ribbon Cable Connectors
- Available with and without eject latches
- Available with and without “kinked” soldertails for PCB retention
- Headers are recognized under the Component Program of Underwriters Laboratories Inc.  File No. E28476
- Headers are certified by Canadian Standards Association,  File No. LR 7189
- Low profile IDC headers are recognized under the Component Program of Underwriters Laboratories Inc.  File No. E60980, Vol. 5

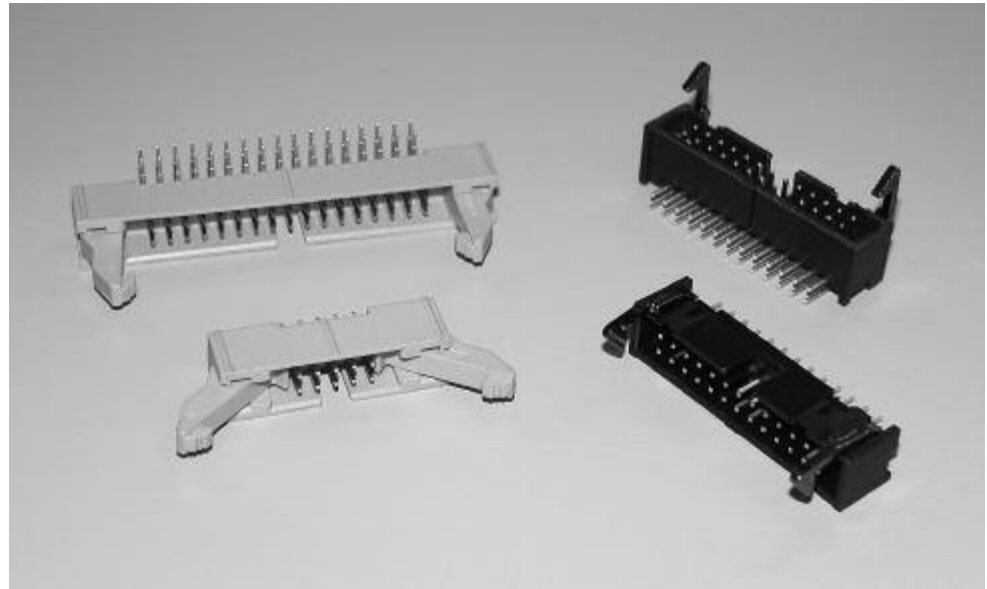

### Performance Characteristics

#### Electrical

- Insulation Resistance** — 5,000 megohms minimum initial
- Dielectric Withstanding Voltage** — 1,000 V rms at sea level
- Current** — 1 ampere maximum per contact
- Operating Voltage** — 250 VAC

#### Environmental

- Operating Temperature** — -65°C to +105°C

### Technical Documents

- Product Specifications**  
108-40018

## Low Profile Pin Headers, Center and Dual Polarized, .100 x .100 [2.54 x 2.54] Centerlines

Low Profile Headers

### Vertical PCB Mount .025 [0.64] Square Post (Mating End)

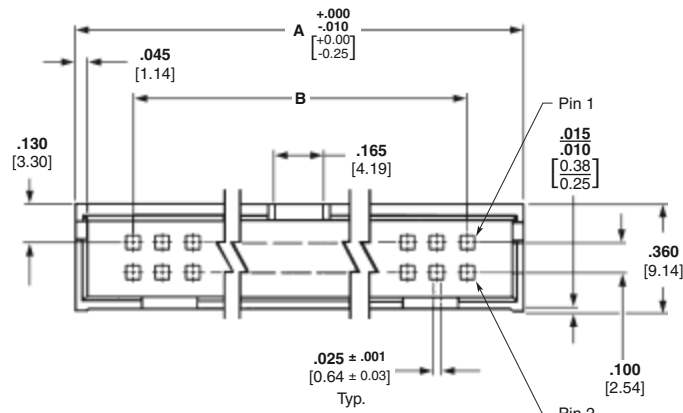
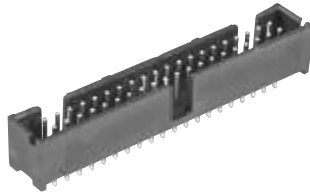

### Material and Finish

**Housing** — Glass-filled nylon, UL 94V-0 rated, black

**Posts** — Brass, plated as follows:

**Plating A** — Duplex plated, gold flash over palladium-nickel, .000030 [0.00076] min. total on mating surfaces, .000100 [0.00254] min. tin on solder area, with entire post underplated .000050 [0.00127] min. nickel  
**or** .000030 [0.00076] min. gold on mating surfaces, .000100 [0.00254] min. tin on solder area, with entire post underplated .000050 [0.00127] min. nickel

**Plating B** — Duplex plated, gold flash over palladium-nickel, .000015 [0.00038] min. total on mating surfaces, .000100 [0.00254] min. tin on solder area, with entire post underplated .000050 [0.00127] min. nickel  
**or** .000015 [0.00038] min. gold on mating surfaces, .000100 [0.00254] min. tin on solder area, with entire post underplated .000050 [0.00127] min. nickel

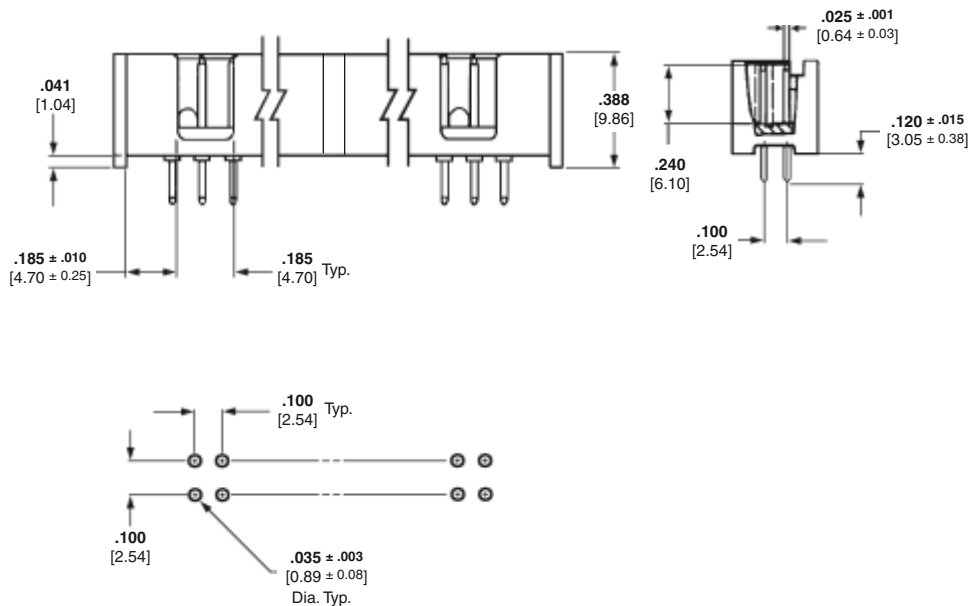

Recommended PC Board Hole Layout For Manual Insertion

### Related Product Data

**Electrical Characteristics** — page 75

**Mateable Connectors** —

**AMPMODU Wire-Applied Receptacles**

**AMPMODU Board Mount Receptacles**

**Short Point Wire-Applied Connectors**

**Novo Receptacles and Female Socket Connectors, 609, 622 and 636 Series** — pages 48-55

No. of Pos.	Dimensions		Post Plating/Part Nos.	
	A	B	Plating A	Plating B
10	.800 [20.32]	.400 [10.16]	5103309-1	5103308-1
14	1.000 [25.40]	.600 [15.24]	5103309-2	5103308-2
16	1.100 [27.94]	.700 [17.78]	5103309-3	5103308-3
20	1.300 [33.02]	.900 [22.86]	5103309-5	5103308-5
24	1.500 [38.10]	1.100 [27.94]	—	1-5103308-3
26	1.600 [40.64]	1.200 [30.48]	5103309-6	5103308-6
34	2.000 [50.80]	1.600 [40.64]	5103309-7	5103308-7
40	2.300 [58.42]	1.900 [48.26]	5103309-8	5103308-8
50	2.800 [71.12]	2.400 [60.96]	1-5103309-0	1-5103308-0
60	3.300 [83.82]	2.900 [73.66]	—	1-5103308-2

**Note:** All part numbers are RoHS compliant.

## Low Profile Pin Headers, Center and Dual Polarized, .100 x .100 [2.54 x 2.54] Centerlines (Continued)

### Right-Angle PCB Mount .025 [0.64] Square Post (Mating End)

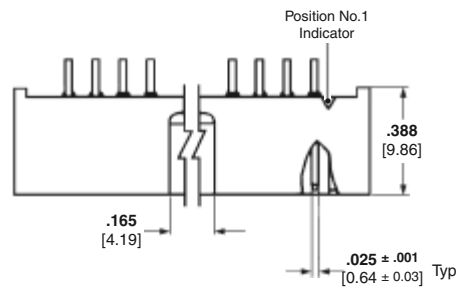
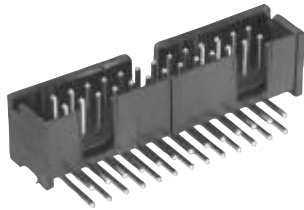

### Material and Finish

**Housing** — Glass-filled nylon, UL 94V-0 rated, black

**Posts** — Brass, plated as follows:

**Plating A** — Duplex plated, gold flash over palladium-nickel, .000030 [0.00076] min. total on mating surfaces, .000100 [0.00254] min. tin on solder area, with entire post underplated .000050 [0.00127] min. nickel  
**or** .000030 [0.00076] min. gold on mating surfaces, .000100 [0.00254] min. tin on solder area, with entire post underplated .000050 [0.00127] min. nickel

**Plating B** — Duplex plated, gold flash over palladium-nickel, .000015 [0.00038] min. total on mating surfaces, .000100 [0.00254] min. tin on solder area, with entire post underplated .000050 [0.00127] min. nickel  
**or** .000015 [0.00038] min. gold on mating surfaces, .000100 [0.00254] min. tin on solder area, with entire post underplated .000050 [0.00127] min. nickel

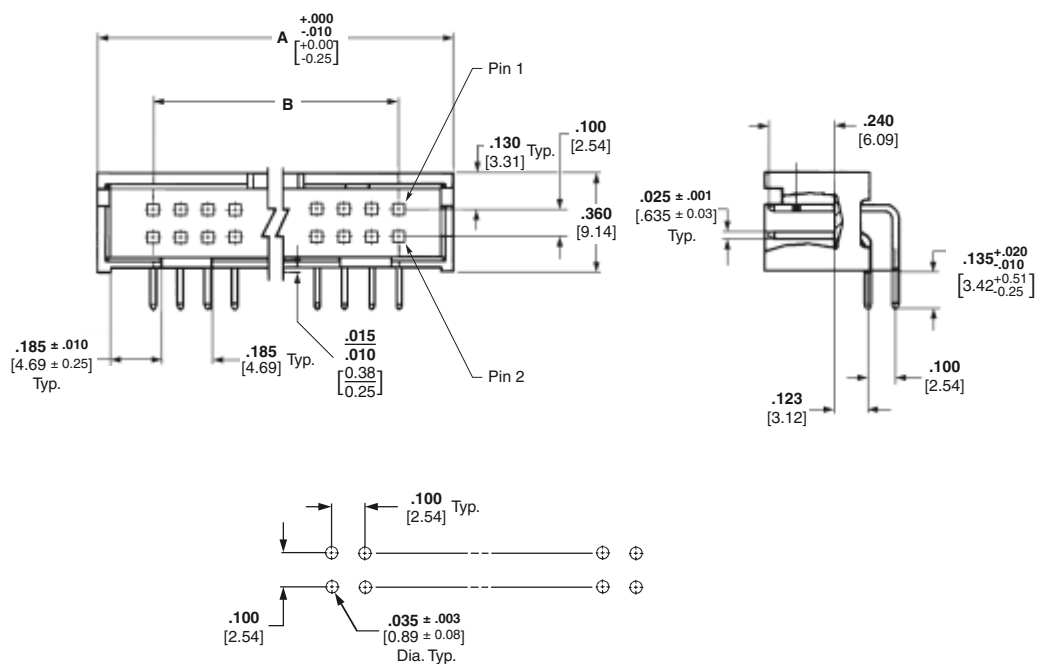

Recommended PC Board Hole Layout  
For Manual Insertion

### Related Product Data

**Electrical Characteristics** — page 75

**Mateable Connectors** — AMPMODU Wire-Applied Receptacles

**Short Point Wire-Applied Connectors**

**Novo Receptacles and Female Socket Connectors, 609, 622 and 636 Series** — pages 48-55

No. of Pos.	Dimensions		Post Plating/Part Nos.	
	A	B	Plating A	Plating B
10	.800 [20.32]	.400 [10.16]	5103311-1	5103310-1
14	1.000 [25.40]	.600 [15.24]	5103311-2	5103310-2
16	1.100 [27.94]	.700 [17.78]	5103311-3	5103310-3
20	1.300 [33.02]	.900 [22.86]	5103311-5	5103310-5
26	1.600 [40.64]	1.200 [30.48]	5103311-6	5103310-6
34	2.000 [50.80]	1.600 [40.64]	5103311-7	5103310-7
40	2.300 [58.42]	1.900 [48.26]	5103311-8	5103310-8
50	2.800 [71.12]	2.400 [60.96]	1-5103311-0	1-5103310-0
60	3.300 [83.82]	2.900 [73.66]	1-5103311-2	—

**Note:** All part numbers are RoHS compliant.



## Low Profile Pin Headers, Center and Dual Polarized, .100 x .100 [2.54 x 2.54] Centerlines & “Kinked” Solder Tails for PCB Retention

Low Profile Headers

**Vertical PCB Mount  
.025 [0.64] Square Post  
(Mating End) with Board  
Retention Feature**

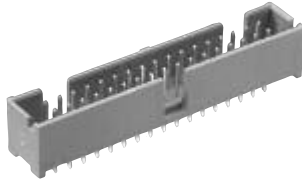

### Material and Finish

**Housing** — Glass-filled PPA, UL 94V-0 rated, black

**Posts** — Brass, plated as follows:

**Plating** — Duplex plated, gold flash over palladium-nickel, .000015 [0.00038] min. total on mating surfaces, .000100 [0.00254] min. tin on solder area, with entire post underplated .000050 [0.00127] min. nickel or .000015 [0.00038] min. gold on mating surfaces, .000100 [0.00254] min. tin on solder area, with entire post underplated .000050 [0.00127] min. nickel

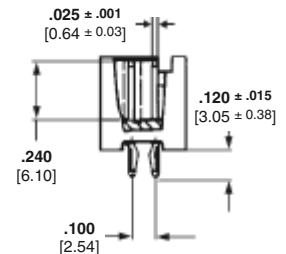
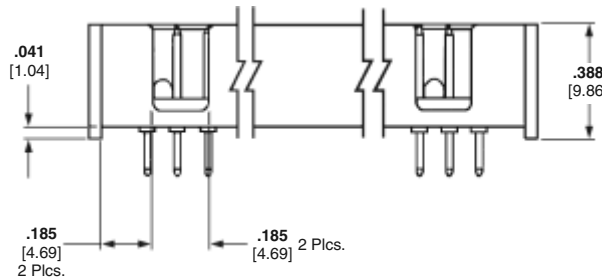
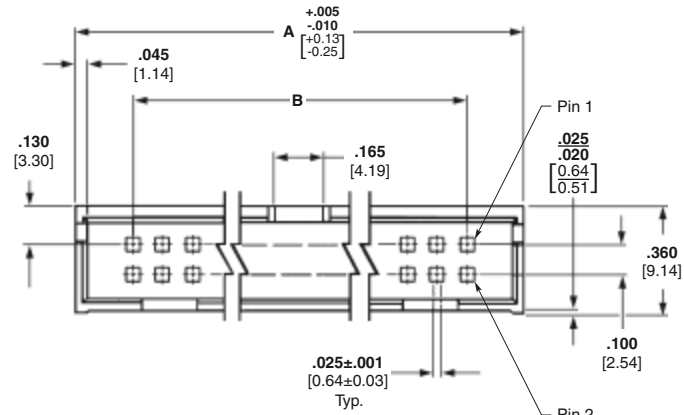

### Related Product Data

**Electrical Characteristics** — page 75

**Mateable Connectors** — AMPMODU Wire-Applied Receptacles

AMPMODU Board Mount Receptacles

Short Point Wire-Applied Connectors

Novo Receptacles and Female Socket Connectors, 609, 622 and 636 Series — pages 48-55

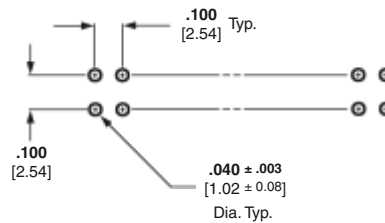

Recommended PC Board Hole Layout For Manual Insertion

No. of Pos.	Dimensions		Post Plating Part Nos.
	A	B	
10	.800 [20.32]	.400 [10.16]	5104338-1
14	1.000 [25.40]	.600 [15.24]	5104338-2
16	1.100 [27.94]	.700 [17.78]	5104338-3
20	1.300 [33.02]	.900 [22.86]	5104338-4
24	1.500 [38.10]	1.100 [27.94]	5104338-5
26	1.600 [40.64]	1.200 [30.48]	5104338-6
34	2.000 [50.80]	1.600 [40.64]	5104338-7
40	2.300 [58.42]	1.900 [48.26]	5104338-8
50	2.800 [71.12]	2.400 [60.96]	5104338-9
60	3.300 [83.82]	2.900 [73.66]	1-5104338-0

**Note:** All part numbers are RoHS compliant.

## Low Profile Pin Headers, Center and Dual Polarized, .100 x .100 [2.54 x 2.54] Centerlines & “Kinked” Solder Tails for PCB Retention (Continued)

### Right-Angle PCB Mount .025 [0.64] Square Post (Mating End) with Board Retention Feature

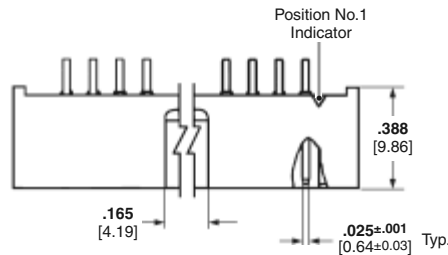
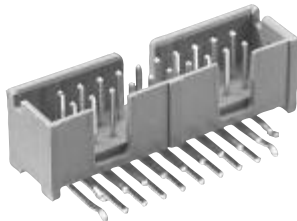

### Material and Finish

**Housing** — Glass-filled PPA, UL 94V-0 rated, black

**Posts** — Brass, plated as follows:

**Plating** — Duplex plated, gold flash over palladium-nickel, .000015 [0.00038] min. total on mating surfaces, .000100 [0.00254] min. tin on solder area, with entire post underplated .000050 [0.00127] min. nickel  
**or** .000015 [0.00038] min. gold on mating surfaces, .000100 [0.00254] min. tin on solder area, with entire post underplated .000050 [0.00127] min. nickel

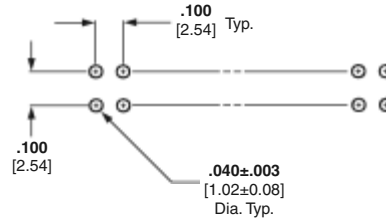
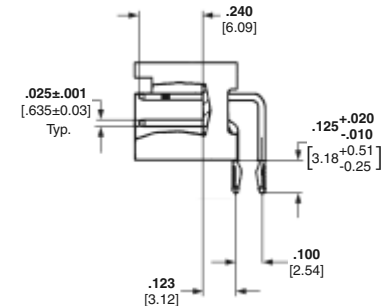
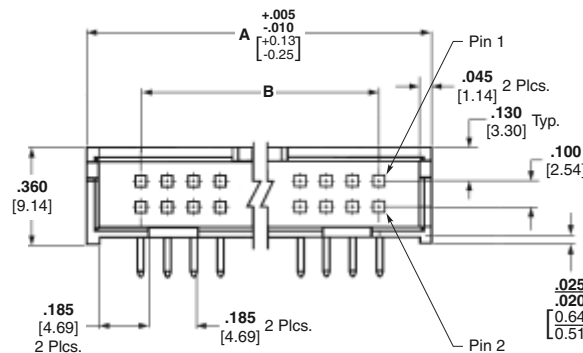

Recommended PC Board Hole Layout For Manual Insertion

### Related Product Data

**Electrical Characteristics** — page 75

**Mateable Connectors** — AMPMODU Wire-Applied Receptacles

**Short Point Wire-Applied Connectors**

**Novo Receptacles and Female Socket Connectors, 609, 622 and 636 Series** — pages 48-55

No. of Pos.	Dimensions		Post Plating Part Nos.
	A	B	
10	.800 [20.32]	.400 [10.16]	5104340-1
14	1.000 [25.40]	.600 [15.24]	5104340-2
16	1.100 [27.94]	.700 [17.78]	5104340-3
20	1.300 [33.02]	.900 [22.86]	5104340-4
24	1.500 [38.10]	1.100 [27.94]	5104340-5
34	2.000 [50.80]	1.600 [40.64]	5104340-7
40	2.300 [58.42]	1.900 [48.26]	5104340-8
50	2.800 [71.12]	2.400 [60.96]	5104340-9

**Note:** All part numbers are RoHS compliant.

## IDC Low Profile Ejection Style Pin Headers with Die Cast Ejection Latches, Military and Center Polarized, .100 x .100 [2.54 x 2.54] Centerlines

IDC Low Profile Headers

### Vertical PCB Mount .025 [0.64] Square Post (Mating End)



#### Material and Finish

**Housing** — Glass-filled PBT, UL 94V-0 rated, black

**Posts** — Brass or phosphor bronze, plated as follows:

**Plating** — Duplex plated, gold flash over palladium-nickel, .000030 [0.00076] min. total on mating surfaces, .000100 [0.00254] min. tin on solder area, with entire post underplated .000050 [0.00127] min. nickel  
or .000030 [0.00076] min. gold on mating surfaces, .000100 [0.00254] min. tin on solder area, with entire post underplated .000050 [0.00127] min. nickel

#### Related Product Data

**Electrical Characteristics** — page 75

**Mateable Connectors** —

**Novo Receptacles and Female Socket Connectors, 609, 622 and 636 Series** — pages 48-55

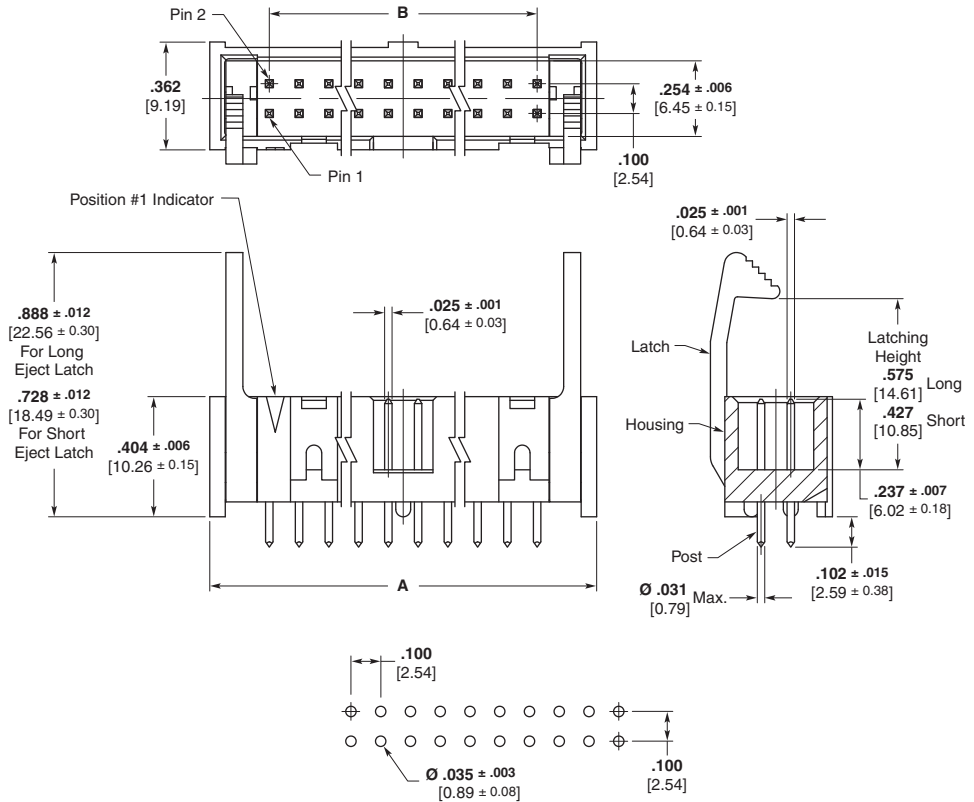

Recommended PC Board Layout

No. of Pos.	Dimensions		Part Numbers	
	A	B	Pin Header with Short Latches (Mates with Receptacles without Strain Relief)	Pin Header with Long Latches (Mates with Receptacles with Strain Relief)
10	.800 20.32	.400 10.16	1761608-3	1761606-3
14	1.000 25.40	.600 15.24	1761608-5	1761606-5
16	1.100 27.94	.700 17.78	1761608-6	1761606-6
20	1.300 33.02	.900 22.86	1761608-7	1761606-7
24	1.500 38.10	1.100 27.94	1761608-8	1761606-8
26	1.600 40.64	1.200 30.48	1761608-9	1761606-9
30	1.800 45.72	1.400 35.56	—	1-1761606-0
34	2.000 50.80	1.600 40.64	1-1761608-1	1-1761606-1
40	2.300 58.42	1.900 48.26	1-1761608-3	1-1761606-3
50	2.800 71.12	2.400 60.96	1-1761608-5	1-1761606-5
60	3.300 83.82	2.900 73.66	1-1761608-6	1-1761606-6

**Note:** All part numbers are RoHS compliant.

## IDC Low Profile Ejection Style Pin Headers with Die Cast Ejection Latches, Military and Center Polarized, .100 x .100 [2.54 x 2.54] Centerlines (Continued)

### Right-Angle PCB Mount .025 [0.64] Square Post (Mating End)

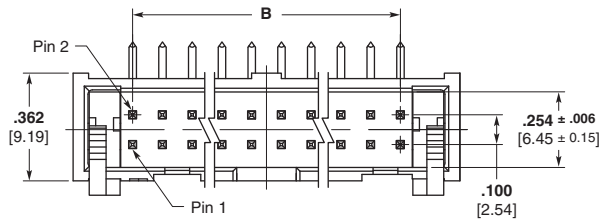

### Material and Finish

**Housing** — Glass-filled PBT, UL 94V-0 rated, black

**Posts** — Brass or phosphor bronze, plated as follows:

**Plating** — Duplex plated, gold flash over palladium-nickel, .000030 [0.00076] min. total on mating surfaces, .000100 [0.00254] min. tin on solder area, with entire post underplated .000050 [0.00127] min. nickel or .000030 [0.00076] min. gold on mating surfaces, .000100 [0.00254] min. tin on solder area, with entire post underplated .000050 [0.00127] min. nickel

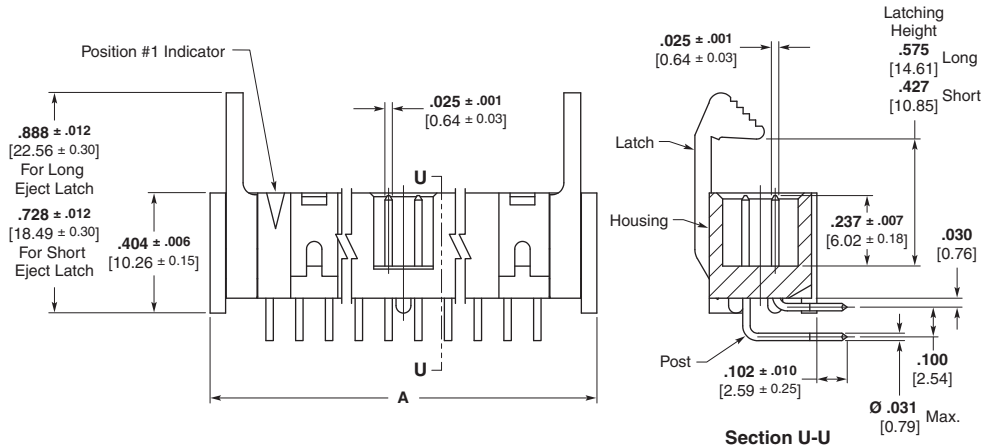

### Related Product Data

**Electrical Characteristics** — page 75

**Mateable Connectors** —

**Novo Receptacles and Female Socket Connectors, 609, 622 and 636 Series** — pages 48-55

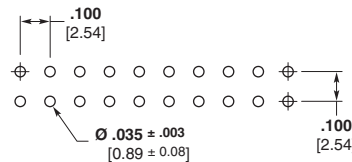

Recommended PC Board Layout

No. of Pos.	Dimensions		Part Numbers	
	A	B	Pin Header with Short Latches (Mates with Receptacles without Strain Relief)	Pin Header with Long Latches (Mates with Receptacles with Strain Relief)
10	.800 20.32	.400 10.16	1761609-3	1761607-3
14	1.000 25.40	.600 15.24	1761609-5	1761607-5
16	1.100 27.94	.700 17.78	1761609-6	1761607-6
20	1.300 33.02	.900 22.86	1761609-7	1761607-7
26	1.600 40.64	1.200 30.48	1761609-9	1761607-9
34	2.000 50.80	1.600 40.64	1-1761609-1	1-1761607-1
40	2.300 58.42	1.900 48.26	1-1761609-3	1-1761607-3
50	2.800 71.12	2.400 60.96	1-1761609-5	1-1761607-5
60	3.300 83.82	2.900 73.66	1-1761609-6	1-1761607-6

**Note:** All part numbers are RoHS compliant.

## IDC Low Profile Ejection Style Pin Headers, Center Polarized, .100 x .100 [2.54 x 2.54] Centerlines

IDC Low Profile Headers

**Vertical PCB Mount  
.025 [0.64] Square Post  
(Mating End)**



**Material and Finish**

**Housing and Eject Latches** — PBT, UL 94V-0 rated, blue

**Posts** — Phosphor bronze, plated as follows:

**Plating** — Duplex plated, .000030 [0.00076] min. gold on mating surfaces, .000100 [0.00254] min. tin on solder area, with entire post underplated .000050 [0.00127] min. nickel

**Related Product Data**

**Electrical Characteristics** — page 75

**Mateable Connectors** — **Novo Receptacles and Female Socket Connectors, 609, 622 and 636 Series** — pages 48-55

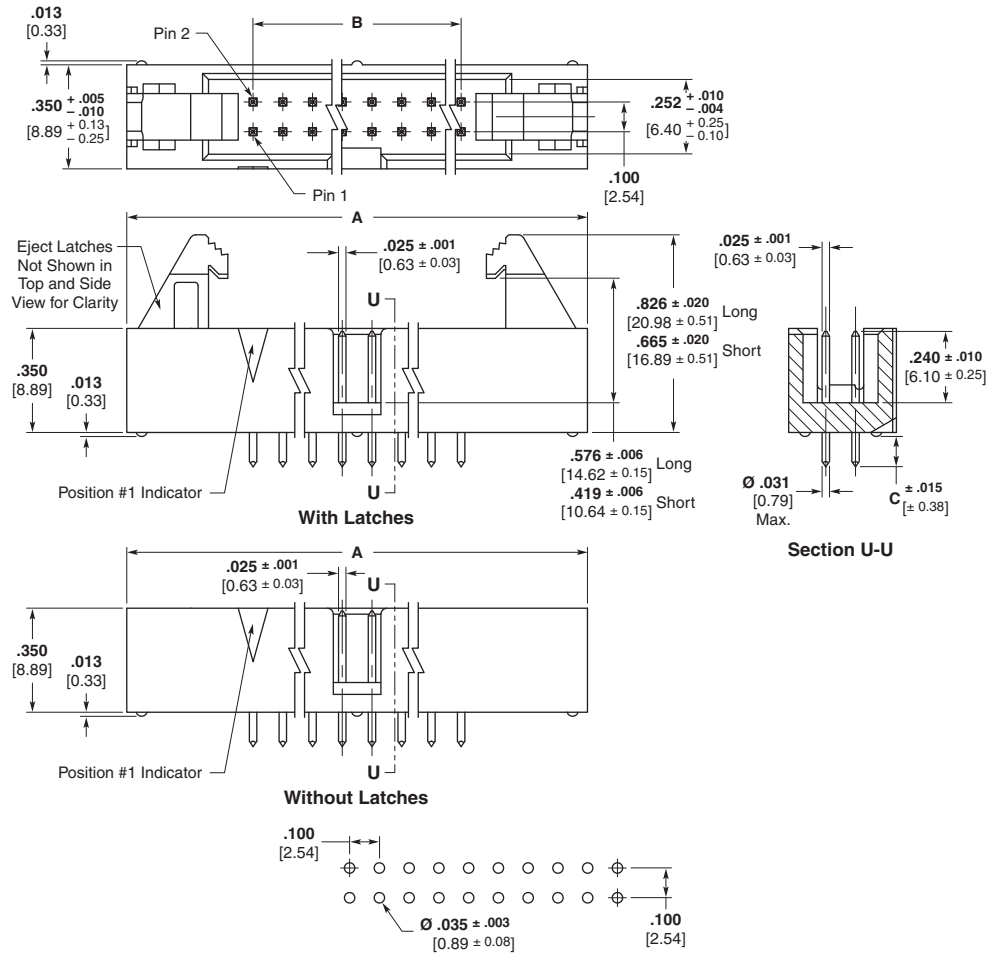

Recommended PC Board Layout

Dim. C (Solder Tail Length)	No. of Pos.	Dimensions		Part Numbers		
		A	B	Pin Header without Latches	Pin Header with Short Latches (Mates with Receptacles without Strain Relief)	Pin Header with Long Latches (Mates with Receptacles with Strain Relief)
.102 2.59	10	1.250 [31.75]	.400 [10.16]	1761693-3	1761685-3	1761686-3
	14	1.450 [36.83]	.600 [15.24]	—	—	1761686-5
	16	1.550 [39.37]	.700 [17.78]	—	1761685-6	1761686-6
	20	1.750 [44.45]	.900 [22.86]	—	1761685-7	1761686-7
	24	1.950 [49.53]	1.100 [27.94]	1761693-8	1761685-8	1761686-8
	26	2.050 [52.07]	1.200 [30.48]	—	1761685-9	1761686-9
	30	2.250 [57.15]	1.400 [35.56]	—	1-1761685-0	—
	34	2.450 [62.23]	1.600 [40.64]	1-1761693-1	1-1761685-1	1-1761686-1
	40	2.750 [69.85]	1.900 [48.26]	—	1-1761685-3	1-1761686-3
	50	3.250 [82.55]	2.400 [60.96]	—	1-1761685-5	1-1761686-5
.165 4.19	10	1.250 [31.75]	.400 [10.16]	1761694-3	1761687-3	—
	14	1.450 [36.83]	.600 [15.24]	—	—	—
	16	1.550 [39.37]	.700 [17.78]	—	—	—
	20	1.750 [44.45]	.900 [22.86]	—	1761687-7	1761688-7
	24	1.950 [49.53]	1.100 [27.94]	—	—	1761688-8
	26	2.050 [52.07]	1.200 [30.48]	1761694-9	1761687-9	1761688-9
	34	2.450 [62.23]	1.600 [40.64]	—	1-1761687-1	1-1761688-1
	40	2.750 [69.85]	1.900 [48.26]	—	1-1761687-3	—
	50	3.250 [82.55]	2.400 [60.96]	—	—	1-1761688-5

Note: All part numbers are RoHS compliant.

## IDC Low Profile Ejection Style Pin Headers, Center Polarized, .100 x .100 [2.54 x 2.54] Centerlines (Continued)

### Right-Angle PCB Mount .025 [0.64] Square Post (Mating End)



#### Material and Finish

**Housing and Eject Latches** — PBT, UL 94V-0 rated, blue

**Posts** — Phosphor bronze, plated as follows:

**Plating** — Duplex plated, .000030 [0.00076] min. gold on mating surfaces, .000100 [0.00254] min. tin on solder area, with entire post underplated .000050 [0.00127] min. nickel

#### Related Product Data

**Electrical Characteristics** — page 75

**Mateable Connectors** —  
**Novo Receptacles and Female Socket Connectors, 609, 622 and 636 Series** — pages 48-55

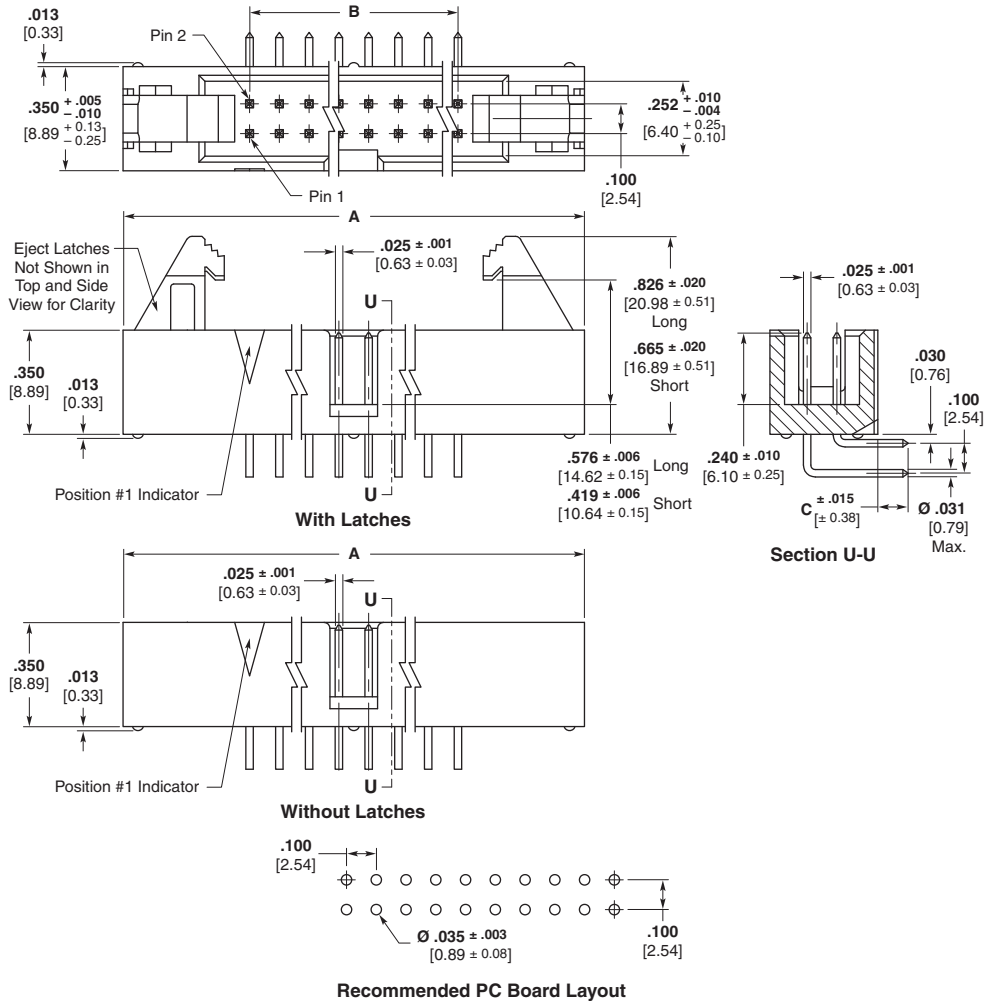

Dim. C (Soldertail Length)	No. of Pos.	Dimensions		Part Numbers
		A	B	Pin Header with Long Latches (Mates with Receptacles with Strain Relief)
.102 2.59	16	1.550 [39.37]	.700 [17.78]	1761690-6
	24	1.950 [49.53]	1.100 [27.94]	1761690-8
	26	2.050 [52.07]	1.200 [30.48]	1761690-9
	30	2.250 [57.15]	1.400 [35.56]	1-1761690-0
	60	3.750 [95.25]	2.900 [73.66]	1-1761690-6
.165 4.19	10	1.250 [31.75]	.400 [10.16]	1761692-3
	34	2.450 [62.23]	1.600 [40.64]	1-1761692-1
	40	2.750 [69.85]	1.900 [48.26]	1-1761692-3

**Note:** All part numbers are RoHS compliant.



## Universal Ejection Style Pin Headers, Military, Center and Dual Polarized, .100 x .100 [2.54 x 2.54] Centerlines

### Vertical PCB Mount .025 [0.64] Sq. Posts (Mating End)



Pin Header  
with Latches



Pin Header  
without Latches

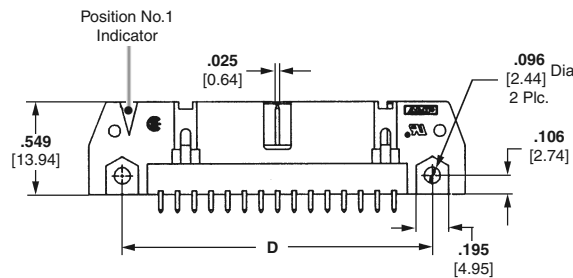
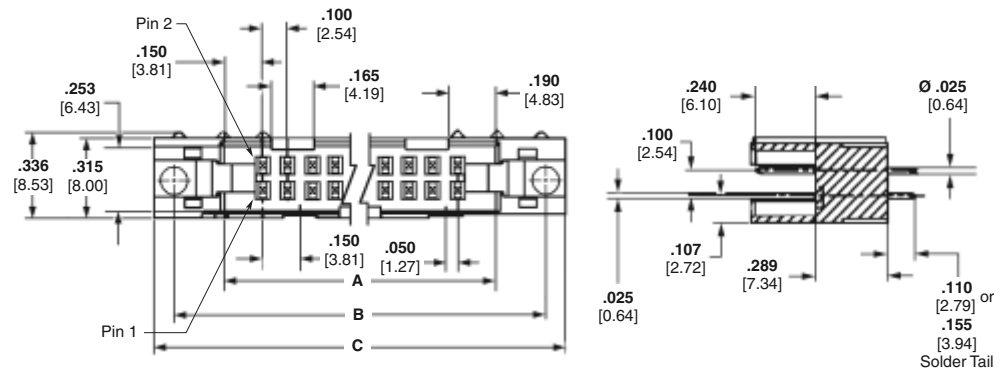

### Material and Finish

**Housing & Latches**—Black PBT or nylon, UL 94V-0 rated

**Contacts** — Brass; duplex plated (See chart, page 85)

### Related Product Data

**Mateable Receptacles** — pages 48-55

**Accessories** —  
**Snap-In Polarizer** — page 63

### Technical Documents

**Product Specifications**  
108-40018 Pin Headers

No. of Positions	Dimensions					
	A	B	C	D	E	F
10	.700	1.100	1.260	.860	1.100	.400
	17.78	27.94	32.00	21.84	27.94	10.16
14	.900	1.300	1.460	1.060	1.300	.600
	22.86	33.02	37.08	26.92	33.02	15.24
16	1.000	1.400	1.560	1.180	1.400	.700
	25.40	35.56	39.62	29.46	35.56	17.78
20	1.200	1.600	1.760	1.360	1.800	.900
	30.48	40.64	44.70	34.54	40.64	22.86
24	1.400	1.800	1.960	1.560	1.800	1.100
	35.56	45.72	49.78	39.62	45.72	27.94
26	1.500	1.900	2.060	1.660	1.900	1.200
	38.10	48.26	52.32	42.16	48.26	30.48
30	1.700	2.100	2.260	1.860	2.100	1.400
	43.18	53.34	57.40	47.24	53.34	35.56
34	1.900	2.300	2.460	2.060	2.300	1.600
	48.26	58.42	62.48	52.32	58.42	40.64
40	2.200	2.600	2.760	2.360	2.600	1.900
	55.88	66.04	70.10	59.94	66.04	48.26
50	2.700	3.100	3.260	2.860	3.100	2.400
	68.58	78.74	82.80	72.64	78.74	60.98
60	3.200	3.600	3.760	3.360	3.600	2.900
	81.28	91.44	95.50	85.34	91.44	73.66
64	3.400	3.800	3.960	3.560	3.800	3.100
	86.36	96.52	100.58	90.42	96.52	78.74

- Notes:**
1. Pin headers in 10- and 14-position sizes have only one slot for snap-in polarizer (military polarization), located as shown.
  2. Pin headers in 10-position size have only slot for dual polarization, located as shown.
  3. For information regarding latch/pin header applications and for ordering latches separately, refer to page 96.

### Universal Ejection Style Pin Headers, Military, Center and Dual Polarized, .100 x .100 [2.54 x 2.54] Centerlines (Continued)

**Vertical PCB Mount  
.025 [0.64] Sq. Posts  
(Mating End) (Continued)**

Soldertail Length	No. of Positions	Contact Finish (Plating Code)	Pin Header without Latches	Pin Header w/ Short Latches (Mates with AMP-LATCH Receptacles without Strain Relief)	Pin Header w/ Long Latches (Mates with AMP-LATCH Receptacles with Strain Relief)
<b>.110</b> 2.79	10	A	5102153-1	5499910-1	5499922-1
		B	5102154-1	5499160-1	5499206-1
	14	A	5102153-2	5499910-2	5499922-2
		B	5102154-2	5499160-2	5499206-2
	16	A	5102153-3	5499910-3	5499922-3
		B	5102154-3	5499160-3	5499206-3
	20	A	5102153-4	5499910-4	5499922-4
		B	5102154-4	5499160-4	5499206-4
	24	A	5102153-5	5499910-5	5499922-5
		B	5102154-5	—	5499206-5
	26	A	5102153-6	5499910-6	5499922-6
		B	5102154-6	5499160-6	5499206-6
	30	A	5102153-7	5499910-7	5499922-7
		B	5102154-7	—	5499206-7
	34	A	5102153-8	5499910-8	5499922-8
		B	5102154-8	5499160-8	5499206-8
	40	A	5102153-9	5499910-9	5499922-9
		B	5102154-9	5499160-9	5499206-9
50	A	1-5102153-0	1-5499910-0	1-5499922-0	
	B	1-5102154-0	1-5499160-0	1-5499206-0	
60	A	—	—	1-5499922-1	
	B	1-5102154-1	—	1-5499206-1	
64	A	1-5102153-2	—	1-5499922-2	
	B	1-5102154-2	1-5499160-2	1-5499206-2	
<b>.155</b> 3.94	10	A	5102155-1	—	5499923-1
		B	5102156-1	5499374-1	5102321-1
	14	A	—	—	—
		B	5102156-2	5499374-2	5102321-2
	16	A	5102155-3	—	5499923-3
		B	5102156-3	—	5102321-3
	20	A	—	—	5499923-4
		B	5102156-4	5499374-4	5102321-4
	24	A	—	—	5499923-5
		B	5102156-5	5499374-5	5102321-5
	26	A	5102155-6	—	5499923-6
		B	5102156-6	5499374-6	5102321-6
	30	A	—	—	5499923-7
		B	5102156-7	—	5102321-7
	34	A	5102155-8	5499911-8	5499923-8
		B	5102156-8	5499374-8	5102321-8
	40	A	5102155-9	5499911-9	5499923-9
		B	5102156-9	5499374-9	5102321-9
50	A	1-5102155-0	—	1-5499923-0	
	B	1-5102156-0	1-5499374-0	1-5102321-0	
60	A	—	—	1-5499923-1	
	B	1-5102156-1	—	1-5102321-1	
64	A	1-5102155-2	—	1-5499923-2	
	B	1-5102156-2	—	1-5102321-2	

**Plating Code A** — Gold flash over palladium-nickel plate, .000015 [0.00038] min. total on the mating surfaces, .000100 [0.00254] min. tin plate on the soldertails, over .000050 [0.00127] min nickel underplate or .000015 [0.00038] min. gold on the mating surfaces, .000100 [0.00254] min. tin plate on the soldertails, over .000050 [0.00127] min. nickel underplate.

**Plating Code B** — Gold flash over palladium-nickel plate, .000030 [0.00076] min. total on the mating surfaces, .000100 [0.00254] min. tin plate on the soldertails, over .000050 [0.00127] min nickel underplate or .000030 [0.00076] min. gold on the mating surfaces, .000100 [0.00254] min. tin plate on the soldertails, over .000050 [0.00127] min. nickel underplate.

**Note:** All part numbers are RoHS compliant.

Military, Center and Dual Polarized, Vertical Mount Universal Ejection Style Pin Headers

## Universal Ejection Style Pin Headers, Military, Center and Dual Polarized, .100 x .100 [2.54 x 2.54] Centerlines (Continued)

### Mounting Information

4-24 self-tapping screws and 2-56 bolts and nuts are available for mounting straight-thru pin headers of pc boards. Typical applications and part nos. for ordering this hardware are presented below.

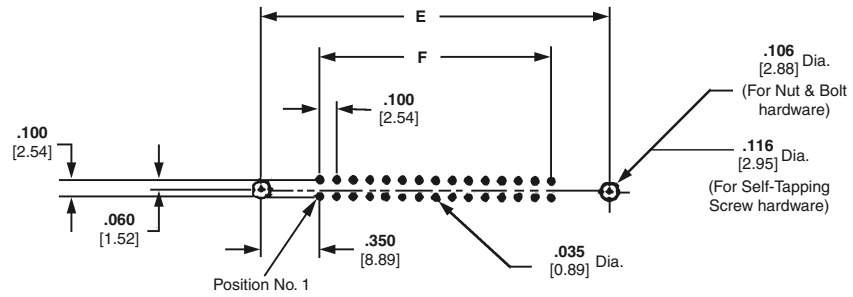

**Recommended Mounting Hole Pattern  
For Vertical PCB Mount Headers**

PC board thicknesses are : .062 [1.57] for .110 [2.79] long posts,  
.125 [3.18] for .155 [3.94] long posts.

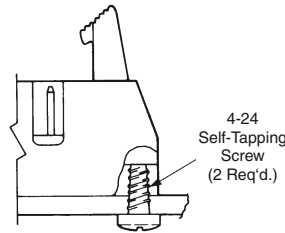

**Pin Header Mounting using 4-24 Self-Tapping Screws:**  
Part No. 19156-1 (for .062 [1.57] Thick PC Board)  
19156-2 (for .093 [2.36] Thick PC Board)  
19156-3 (for .125 [3.18] Thick PC Board)

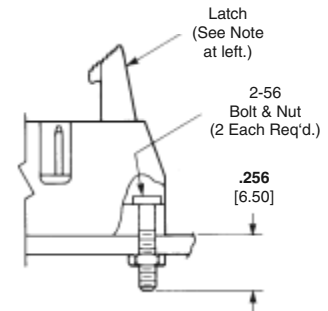

**Pin Header Mounting with 2-56 Bolts and Nuts:**  
Part No. 746383-1 (Bolt Only)  
Kit No. 102198-1 (Bolt and Nut, 2 Each per Kit)

**Note:** 2-56 bolts and nuts may be used to mount pin headers with and without latches. If latches are to be used, the bolts must be positioned in the pin header before the latches are installed.

**Note:** All part numbers are RoHS compliant.

## Universal Ejection Style Pin Headers with ACTION PIN Contacts, Military, Center and Dual Polarized, .100 x .100 [2.54 x 2.54] Centerlines

**Vertical PCB Mount  
.025 [0.64] Sq. Posts  
(Mating End)**



**Pin Header  
without Latches**

**Material and Finish**

**Housing** — Black PBT or nylon, UL 94V-0 rated

**Contacts**—Copper alloy; duplex plated (See chart, page 88)

**Related Product Data**

**Mateable Receptacles** — pages 48-55

**Accessories** —

**Snap-In Polarizer** — page 63

**Technical Documents**

**Product Specifications**

108-40019 Pin Headers with ACTION PIN Contacts

**Application Specification**

114-40020 AMP-LATCH Universal Headers with ACTION PIN Contacts

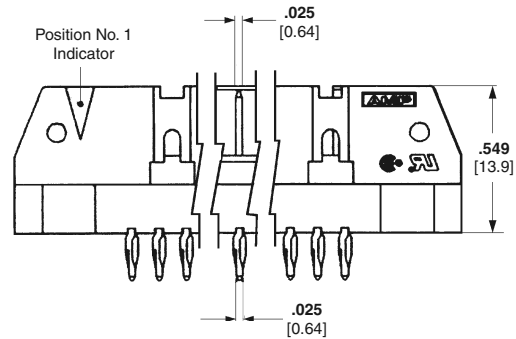
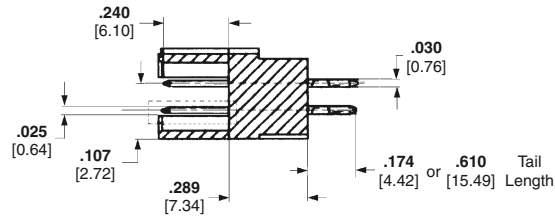
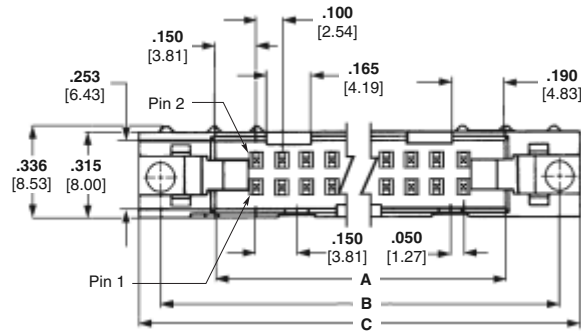

No. of Positions	Dimensions				
	A	B	C	D	E
10	.700 17.78	1.100 27.94	1.260 32.00	1.100 27.94	.400 10.16
14	.900 22.86	1.300 33.02	1.460 37.08	1.300 33.02	.600 15.24
16	1.000 25.40	1.400 35.56	1.560 39.62	1.400 35.56	.700 17.78
20	1.200 30.48	1.600 40.64	1.760 44.70	1.600 40.64	.900 22.86
24	1.400 35.56	1.800 45.72	1.960 49.78	1.800 45.72	1.100 27.94
26	1.500 38.10	1.900 48.26	2.060 52.32	1.900 48.26	1.200 30.48
30	1.700 43.18	2.100 53.34	2.260 57.40	2.100 53.34	1.400 35.56
34	1.900 48.26	2.300 58.42	2.460 62.48	2.300 58.42	1.600 40.64
40	2.200 55.88	2.600 66.04	2.760 70.10	2.600 66.04	1.900 48.26
50	2.700 68.58	3.100 78.74	3.260 82.80	3.100 78.74	2.400 60.96
60	3.200 81.28	3.600 91.44	3.760 95.50	3.600 91.44	2.900 73.66
64	3.400 86.36	3.800 96.52	3.960 100.58	3.800 96.52	3.100 78.74

- Notes:**
1. Pin headers in 10- and 14-position sizes have only one slot for snap-in polarizer (military polarization), located as shown.
  2. Pin headers in 10-position size have only slot for dual polarization, located as shown.
  3. For information regarding latch/pin header applications and for ordering latches separately, refer to page 96.

**Universal Ejection Style Pin Headers with ACTION PIN Contacts, Military, Center and Dual Polarized, .100 x .100 [2.54 x 2.54] Centerlines** (Continued)

Tail Length	No. of Positions	Contact Finish (Plating Code)	Pin Header (without Latches)
.174 [4.42]	10	B	1658694-6
	14		1658694-7
	16		1658694-8
	20		1658694-1
	24		1658694-9
	26		1658694-2
	30		1-1658694-0
	34		1-1658694-1
	40		1658694-3
	50		1658694-4
.610 [15.49]	64	B	1658694-5
	10		1658695-2
	14		1658695-3
	16		1658695-4
	20		1658695-5
	26		1658695-6
	34		1658695-1
	40		1658695-7
	50		1658695-8
	60		1658695-9

**Plating Code B** — Gold flash over palladium-nickel plate, .000030 [0.00076] min. total on the mating surfaces, .000100 [0.00254] min. tin plate on the tails, over .000050 [0.00127] min nickel underplate **or** .000030 [0.00076] min. gold on the mating surfaces, .000100 [0.00254] min. tin plate on the tails, over .000050 [0.00127] min. nickel underplate.

**Mounting Information**

4-24 self-tapping screws and 2-56 bolts and nuts are available for mounting straight-thru pin headers of pc boards. Typical applications and part nos. for ordering this hardware are presented on page 86.

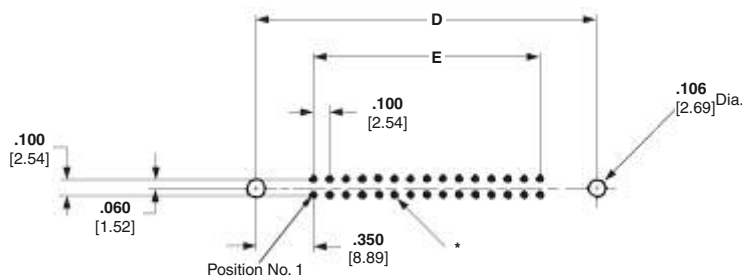

**Recommended Mounting Hole Pattern For Vertical PCB Mount Header With ACTION PIN Contacts**

\*For .080 [2.03] min. thick PCB refer to Application Specification 114-40020 for hole size and finish recommendations.

**Note:** All part numbers are RoHS compliant.

Military, Center and Dual Polarized Universal Ejection Style Pin Headers with ACTION PIN Contacts

## Universal Ejection Style Pin Headers, Military, Center and Dual Polarized, .100 x .100 [2.54 x 2.54] Centerlines

### Right-Angle PCB Mount .025 [0.64] Sq. Posts (Mating End)



Pin Header  
with Latches



Pin Header  
without Latches

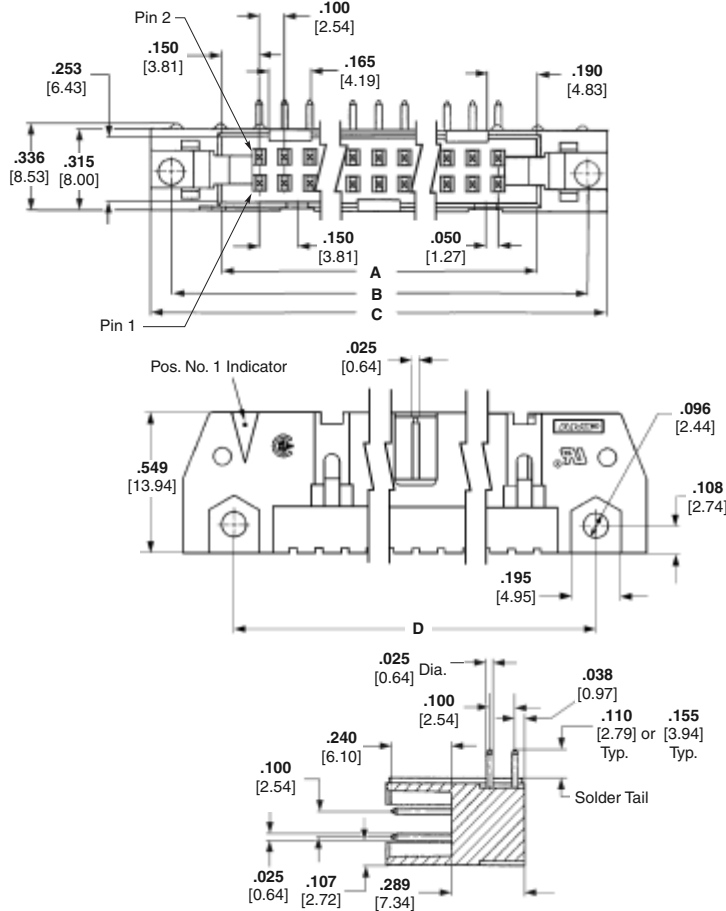

### Material and Finish

**Housing & Latches** — Black PBT or nylon, UL 94V-0 rated

**Contacts** — Brass; duplex plated (See chart, page 90)

### Related Product Data

**Mateable Receptacles** — pages 48-55

**Accessories** —

**Snap-In Polarizer** — page 63

### Technical Documents

#### Product Specifications

108-40018 Pin Headers

No. of Positions	Dimensions					
	A	B	C	D	E	F
10	.700 17.78	1.100 27.94	1.260 32.00	.860 21.84	.860 21.84	.400 10.16
14	.900 22.86	1.300 33.02	1.460 37.08	1.060 26.92	1.060 26.92	.600 15.24
16	1.000 25.40	1.400 35.56	1.560 39.62	1.180 29.46	1.180 29.46	.700 17.78
20	1.200 30.48	1.600 40.64	1.760 44.70	1.380 34.54	1.380 34.54	.900 22.86
24	1.400 35.56	1.800 45.72	1.960 49.78	1.560 39.62	1.560 39.62	1.100 27.94
26	1.500 38.10	1.900 48.26	2.060 52.32	1.660 42.16	1.660 42.16	1.200 30.48
30	1.700 43.18	2.100 53.34	2.260 57.40	1.860 47.24	1.860 47.24	1.400 35.56
34	1.900 48.26	2.300 58.42	2.460 62.48	2.060 52.32	2.060 52.32	1.600 40.64
40	2.200 55.88	2.600 66.04	2.760 70.10	2.360 59.94	2.360 59.94	1.900 48.26
50	2.700 68.58	3.100 78.74	3.260 82.80	2.860 72.64	2.860 72.64	2.400 60.98
60	3.200 81.28	3.600 91.44	3.760 95.50	3.360 85.34	3.360 85.34	2.900 73.66
64	3.400 86.36	3.800 96.52	3.960 100.58	3.560 90.42	3.560 90.42	3.100 78.74

**Notes:** 1. Pin headers in 10- and 14-position sizes have only one slot for snap-in polarizer (military polarization), located as shown.  
2. Pin headers in 10-position size have only slot for dual polarization, located as shown.



## Universal Ejection Style Pin Headers, Military, Center and Dual Polarized, .100 x .100 [2.54 x 2.54] Centerlines (Continued)

**Right-Angle PCB Mount  
.025 [0.64] Sq. Posts  
(Mating End) (Continued)**

Soldertail Length	No. of Positions	Contact Finish (Plating Code)	Pin Header without Latches	Pin Header w/ Short Latches (Mates with Receptacles without Strain Relief)	Pin Header w/ Long Latches (Mates with Receptacles with Strain Relief)
<b>.110</b> 2.79	10	A	5102159-1	5499913-1	5499786-1
		B	5102160-1	5499345-1	5499141-1
	14	A	5102159-2	5499913-2	5499786-2
		B	—	5499345-2	5499141-2
	16	A	5102159-3	5499913-3	—
		B	5102160-3	—	5499141-3
	20	A	5102159-4	5499913-4	5499786-4
		B	5102160-4	—	5499141-4
	24	A	—	5499913-5	5499786-5
		B	5102160-5	5499345-5	—
	26	A	5102159-6	5499913-6	5499786-6
		B	5102160-6	—	5499141-6
	30	A	5102159-7	5499913-7	—
		B	—	—	5499141-7
	34	A	5102159-8	5499913-8	5499786-8
		B	5102160-8	—	5499141-8
	40	A	5102159-9	5499913-9	5499786-9
		B	5102160-9	5499345-9	5499141-9
	50	A	1-5102159-0	1-5499913-0	1-5499786-0
		B	1-5102160-0	1-5499345-0	1-5499141-0
	60	A	1-5102159-1	1-5499913-1	1-5499786-1
		B	1-5102160-1	—	1-5499141-1
	64	A	1-5102159-2	—	1-5499786-2
		B	1-5102160-2	—	1-5499141-2
<b>.155</b> 3.94	10	A	—	—	—
		B	5102162-1	—	5102322-1
	14	A	5102161-2	—	5499925-2
		B	5102162-2	—	5102322-2
	16	A	—	—	—
		B	—	—	5102322-3
	20	A	5102161-4	5499914-4	—
		B	—	—	5102322-4
	24	A	5102161-5	—	5499925-5
		B	5102162-5	—	5102322-5
	26	A	—	—	—
		B	—	—	5102322-6
	30	A	5102161-7	—	—
		B	5102162-7	—	—
	34	A	5102161-8	5499914-8	—
		B	5102162-8	—	5102322-8
	40	A	—	—	—
		B	—	5499376-9	—
	50	A	—	—	1-5499925-0
		B	1-5102162-0	—	—
	60	A	—	—	—
		B	1-5102162-1	—	—
	64	A	—	—	—
		B	1-5102162-2	—	—

**Plating Code A** — Gold flash over palladium-nickel plate, .000015 [0.00038] min. total on the mating surfaces, .000100 [0.00254] min. tin plate on the soldertails, over .000050 [0.00127] min nickel underplate **or** .000015 [0.00038] min. gold on the mating surfaces, .000100 [0.00254] min. tin plate on the soldertails, over .000050 [0.00127] min. nickel underplate.

**Plating Code B** — Gold flash over palladium-nickel plate, .000030 [0.00076] min. total on the mating surfaces, .000100 [0.00254] min. tin plate on the soldertails, over .000050 [0.00127] min nickel underplate **or** .000030 [0.00076] min. gold on the mating surfaces, .000100 [0.00254] min. tin plate on the soldertails, over .000050 [0.00127] min. nickel underplate.

**Note:** All part numbers are RoHS compliant.

## Universal Ejection Style Pin Headers, Military, Center and Dual Polarized, .100 x .100 [2.54 x 2.54] Centerlines (Continued)

### Mounting Information

No mounting hardware is supplied by TE.

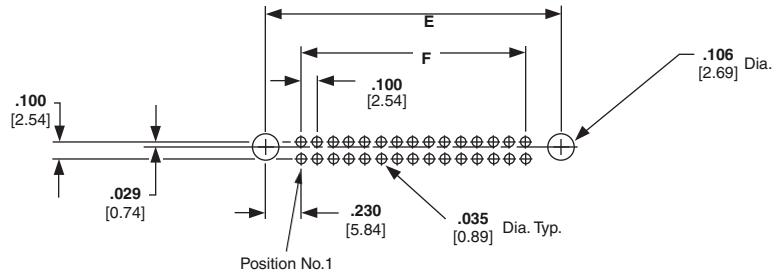

### Recommended Mounting Hole Pattern For Right-Angle PCB Mount Headers

PC board thicknesses are : .062 [1.57] for .110 [2.79] long posts,  
 .125 [3.18] for .155 [3.94] long posts.

## Universal Ejection Style Pinless Headers, Military, Center and Dual Polarized, .100 x .100 [2.54 x 2.54] Centerlines

**Vertical PCB Mount  
.025 [0.64] Sq. Posts  
(without latches)**



**Pinless Header**

**Material and Finish**

**Housing** — Black PBT or nylon,  
UL 94V-0 rated

**Related Product Data**

**Mateable Receptacles** —  
pages 48-55

**Accessories** —  
**Snap-In Polarizer** — page 63

**Technical Documents**

**Product Specifications**

108-40018 Pin Headers

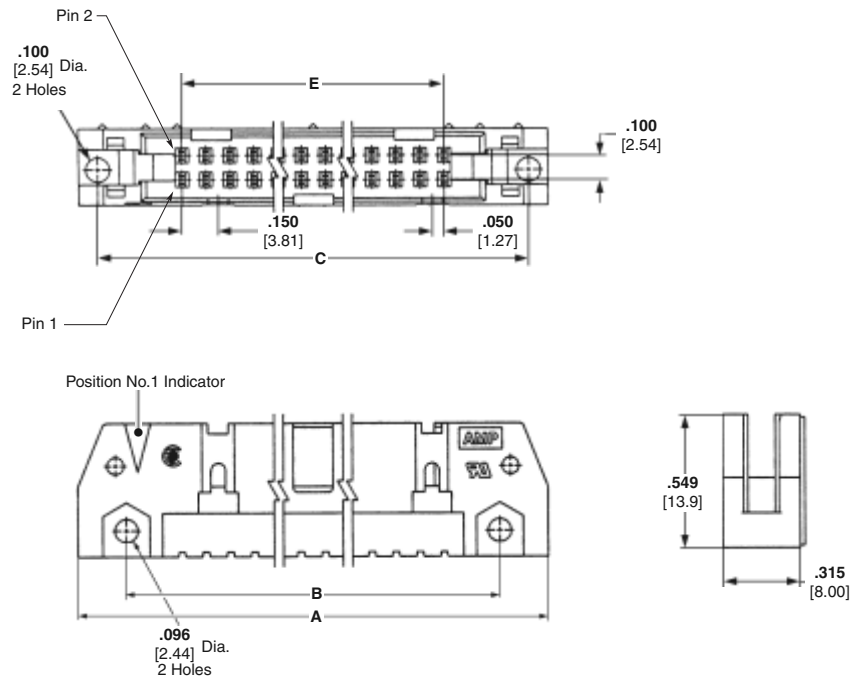

No. of Pos.	Dimensions				Pinless Header Part Nos.	
	A	B	C	E	Press-Fit	Clearance-Fit
10	1.260 32.00	.860 21.84	1.100 27.94	.400 10.16	499726-1	102142-6
14	1.460 37.08	1.060 26.92	1.300 33.02	.600 15.24	—	102142-8
16	1.560 39.62	1.160 29.46	1.400 35.56	.700 17.78	—	102142-9
20	1.760 44.70	1.360 34.54	1.600 40.64	.900 22.86	—	102142-1
24	1.960 49.78	1.560 39.62	1.800 45.72	1.100 27.94	—	1-102142-0
26	2.060 52.32	1.660 42.16	1.900 48.26	1.200 30.48	—	102142-2
34	2.460 62.48	2.060 52.32	2.300 58.42	1.600 40.64	499726-8	102142-3
40	2.760 70.10	2.360 59.94	2.600 66.04	1.900 48.26	499726-9	102142-4
50	3.260 82.80	2.860 72.64	3.100 78.74	2.400 60.96	1-499726-0	102142-5
60	3.760 95.50	3.360 85.34	3.600 91.44	2.900 73.66	1-499726-1	102142-7
64	3.960 100.58	3.560 90.42	3.800 96.52	3.100 78.74	1-499726-2	1-102142-3

- Notes:**
- 10- and 14-position pinless headers have only one slot for snap-in polarizer (military polarization).
  - 10-position pinless headers have only one slot for dual polarization.
  - For information regarding latch/pin header applications and for ordering latches separately, refer to page 96.
- All part numbers are RoHS compliant.

**Note:** All part numbers are RoHS compliant.

## Universal Ejection Style Pinless Headers, Military, Center and Dual Polarized, .100 x .100 [2.54 x 2.54] Centerlines (Continued)

### Installation of Press-Fit Pinless Headers

#### Insertion Instructions:

1. Place pinless header over preinstalled posts so that post tips start into header cavities.
2. With bottom of pc board supported, place steel block over header. Steel block must be wider and longer than header so that it covers all four sides of the header. However, for headers with latches pre-assembled, the steel block must not interfere with the latches.
3. Apply an even, centered force on steel block until header bottoms on pc board. If posts are longer than .545 [13.84], they may be forced against the steel block before the header is fully seated. In this situation, extreme caution must be taken so that posts are not damaged or pushed out of the pc board.

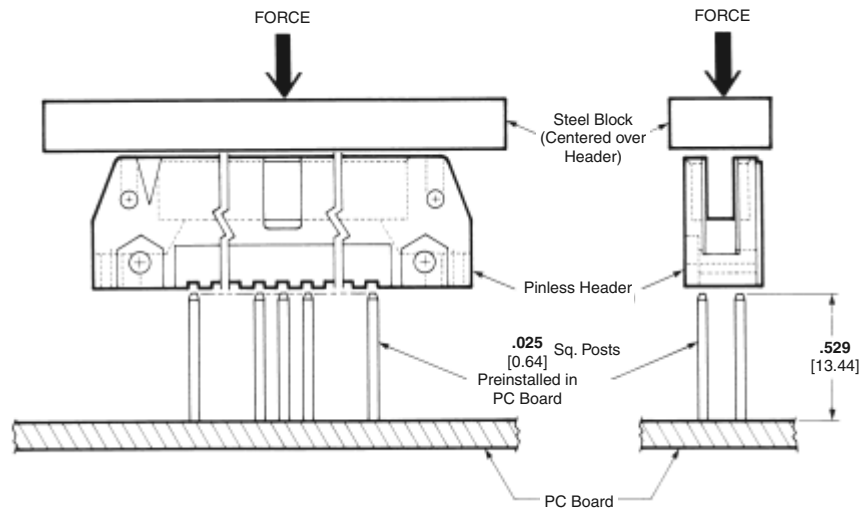

**Insertion Force:** 60 lb. [267 N] max.

**Retention Force:** 20 lb. [89 N] min.

**TE recommends the use of a typical manual frame assembly for insertion of pinless headers. The frame assembly and steel block are not supplied by TE.**

## Universal Ejection Style Pin Headers with PCT Housing, .100 x .100 [2.54 x 2.54] Centerlines, .025 [0.64] Sq. Posts (Mating End)

.100 x .100 [2.54 x 2.54], .025 [0.64] Sq. Posts (Mating End)  
Universal Ejection Style Pin Headers with PCT Housing



Vertical PCB Mount



Right-Angle PCB Mount

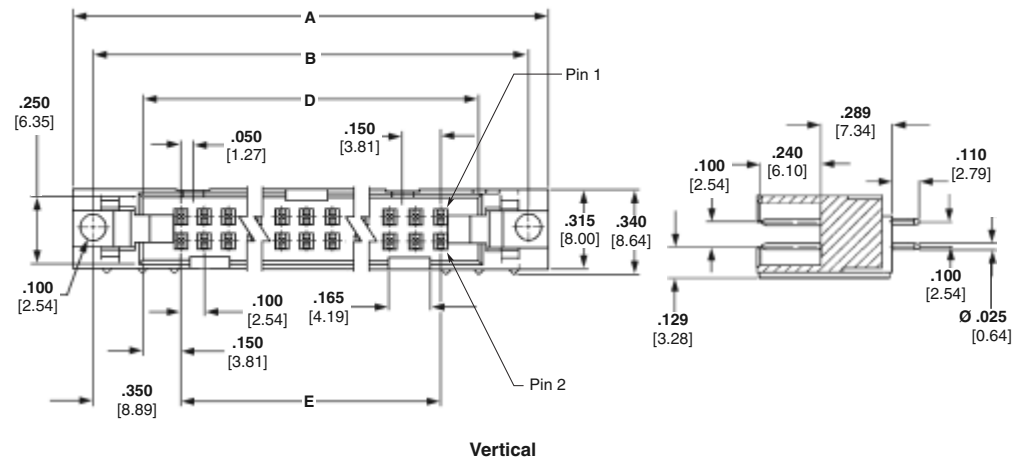
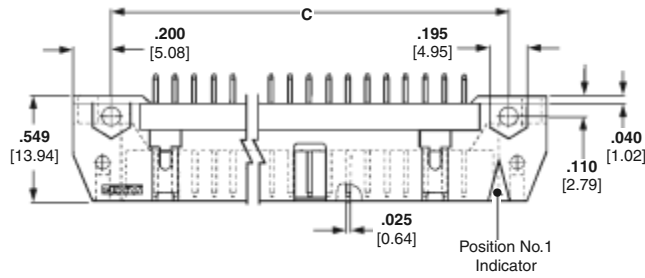

Vertical

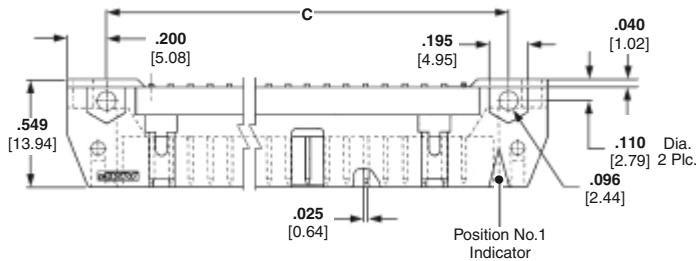

Right-Angle

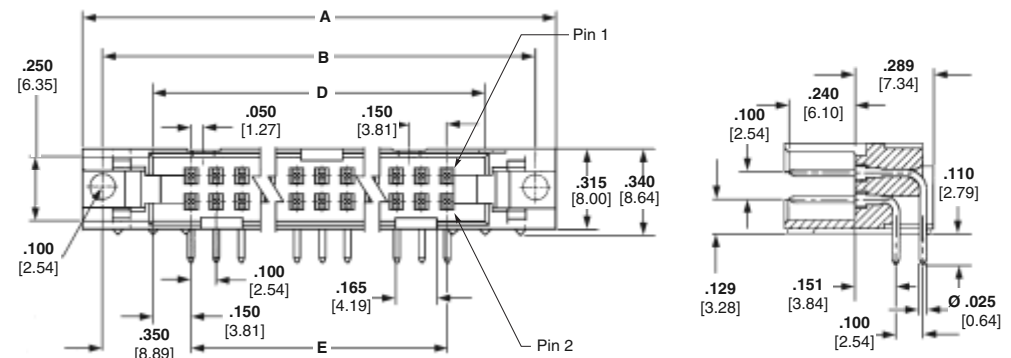

### Material and Finish

**Housing** — Red PCT, UL 94V-0 rated  
**Contacts** — Brass; Gold flash over palladium-nickel plate, .000030 [0.00076] min. total on the mating surfaces, .000100 [0.00254] min. tin plate on the soldertails, over .000050 [0.00127] min. nickel underplate **or** .000030 [0.00076] min. gold on the mating surfaces, .000100 [0.00254] min. tin plate on the soldertails, over .000050 [0.00127] min. nickel underplate

### Related Product Data

**Mateable Receptacles** — pages 48-55

**Accessories** —  
**Snap-In Polarizer** — page 63

### Technical Documents

**Product Specifications**  
 108-40018 Pin Headers

### Universal Ejection Style Pin Headers with PCT Housing, .100 x .100 [2.54 x 2.54] Centerlines, .025 [0.64] Sq. Posts (Mating End) (Continued)

No. of Pos.	Dimensions					Part Numbers	
	A	B	C	D	E	Vertical Pin Header (without Latches)	Right-Angle Pin Header (without Latches)
10	1.260 32.00	1.100 27.94	.860 21.84	.700 17.78	.400 10.16	5111008-1	—
14	1.460 37.08	1.300 33.02	1.060 26.92	.900 22.86	.600 15.24	—	5111105-2
16	1.560 39.62	1.400 35.56	1.160 29.46	1.000 25.40	.700 17.78	—	5111105-3
20	1.760 44.70	1.600 40.64	1.360 34.54	1.200 30.48	.900 22.86	—	5111105-4
24	1.960 49.78	1.800 40.64	1.560 39.62	1.400 35.56	1.100 27.94	5111008-5	5111105-5
26	2.060 52.32	1.900 48.26	1.660 42.16	1.500 38.10	1.200 30.48	—	5111105-6
30	2.260 57.40	2.100 53.34	1.860 47.24	1.700 43.18	1.400 35.56	5111008-7	5111105-7
34	2.460 62.48	2.300 58.42	2.060 52.32	1.900 48.26	1.600 40.64	5111008-8	5111105-8
40	2.760 70.10	2.600 66.04	2.360 59.94	2.200 55.88	1.900 48.26	5111008-9	5111105-9
50	3.260 82.80	3.100 78.74	2.860 72.64	2.700 68.58	2.400 60.98	1-5111008-0	1-5111105-0
60	3.760 95.50	3.600 91.44	3.360 85.34	3.200 81.28	2.900 73.66	1-5111008-1	1-5111105-1
64	3.960 100.58	3.800 96.52	3.560 90.42	3.400 86.36	3.100 78.74	1-5111008-2	1-5111105-2

.100 x .100 [2.54 x 2.54], .025 [0.64] Sq. Posts (Mating End)  
Universal Ejection Style Pin Headers with PCT Housing

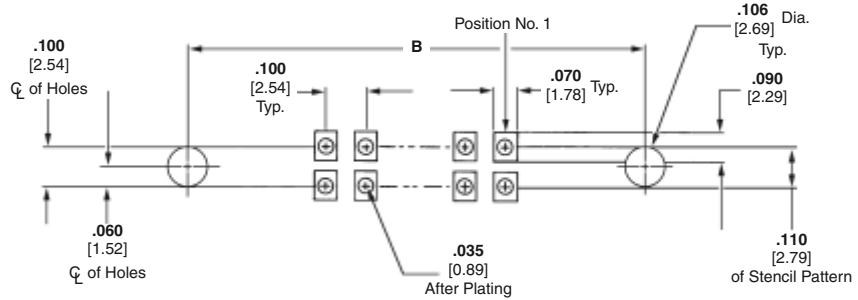

Recommended PC Board Mounting Pattern for Vertical Header

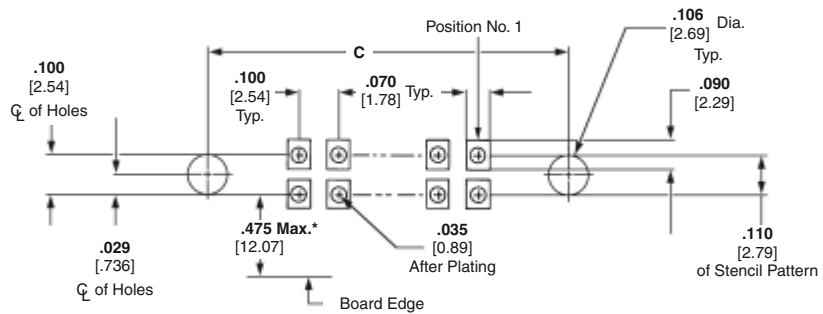

Recommended PC Board Mounting Pattern for Right-Angle Header

\*Max. distance from edge of PC board for daisy chain applications

**Note:** All part numbers are RoHS compliant.



## Latches for Ejection Style Universal Pin Headers and Pinless Headers

### Latch/Pin Header Applications

**Latches for use with Novo Receptacles and Female Socket Connectors, 609, 622 & 636 Series**

**Material**

Red PCT, UL 94V-0 Rated

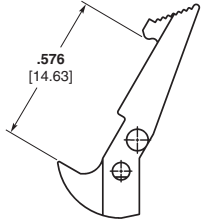

**Long Latch Part No. 111338-1**  
(See Figure 1)

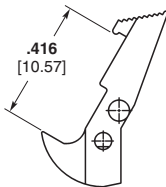

**Short Latch Part No. 111293-1**  
(See Figure 2)

**Material**

Black thermoplastic, UL 94V-0 Rated

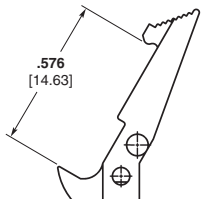

**Long Latch Part No. 102320-1**  
(See Figure 1)

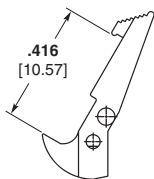

**Short Latch Part No. 102312-1**  
(See Figure 2)

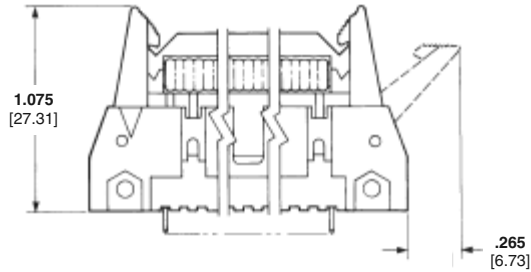

**Figure 1 — Use Long Latch for AMP-LATCH Novo Receptacles with Strain Relief & Female Socket Connectors with Strain Relief**

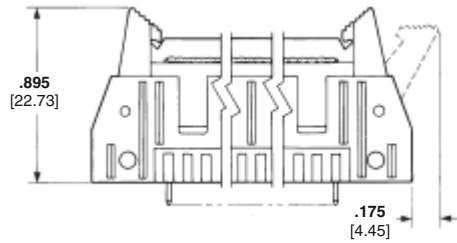

**Figure 2 — Use Short Latch for AMP-LATCH Novo Receptacles without Strain Relief & Female Socket Connectors without Strain Relief**

**Material**

Black thermoplastic, UL 94V-0 Rated

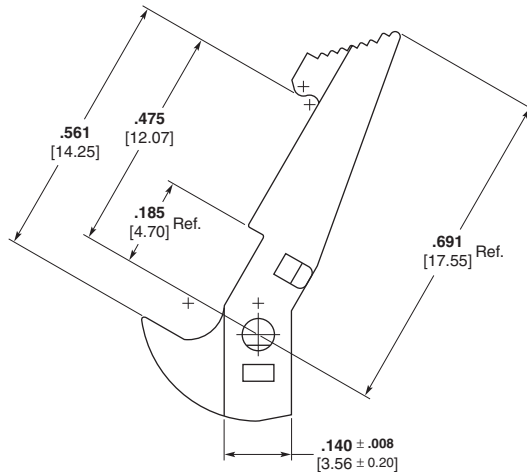

**Special Long Latch Part No. 1825851-1 for AMPMODU Mod IV Housing with Center Polarization Key**

**Note:** All part numbers are RoHS compliant.

## Cable Solutions

**.100 [2.54] Centerline,  
IDC Ribbon Cable,  
PVC Insulation**

**Product Specifications**

- Voltage Rating** — 300 Volts
- UL Recognized** — AWM Style 2651
- CSA** — Available on request

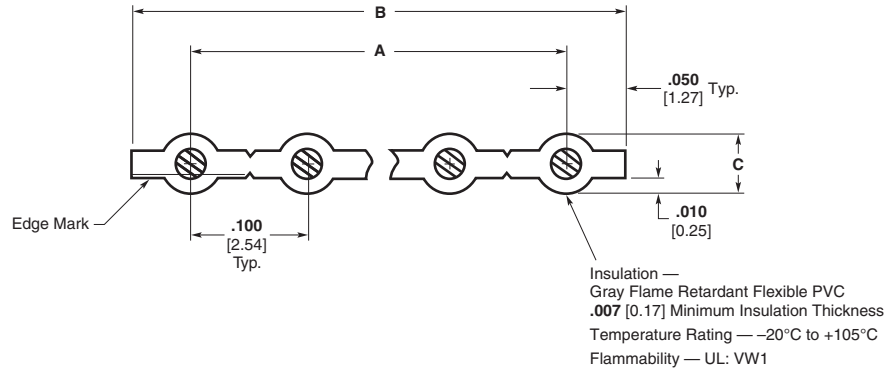

No. of Conductors	Dimensions			Part Number
	A	B	C	
<b>24 AWG 7/32 Tinned Copper</b>				
2	.100 [2.54]	.200 [5.08]	.044 [1.12]	57746-2
5	.400 [10.16]	.500 [12.70]	.044 [1.12]	57746-5
10	.900 [22.86]	1.000 [25.40]	.044 [1.12]	1-57746-0
15	1.400 [35.56]	1.500 [38.10]	.044 [1.12]	1-57746-5
20	1.900 [48.26]	2.000 [50.80]	.044 [1.12]	2-57746-0
25	2.400 [60.96]	2.500 [63.50]	.044 [1.12]	2-57746-5
28	2.700 [68.58]	2.800 [71.12]	.044 [1.12]	2-57746-8
<b>26 AWG 7/34 Tinned Copper</b>				
2	.100 [2.54]	.200 [5.08]	.039 [0.99]	57744-2
5	.400 [10.16]	.500 [12.70]	.039 [0.99]	57744-5
10	.900 [22.86]	1.000 [25.40]	.039 [0.99]	1-57744-0
15	1.400 [35.56]	1.500 [38.10]	.039 [0.99]	1-57744-5
20	1.900 [48.26]	2.000 [50.80]	.039 [0.99]	2-57744-0
25	2.400 [60.96]	2.500 [63.50]	.039 [0.99]	2-57744-5
28	2.700 [68.58]	2.800 [71.12]	.039 [0.99]	2-57744-8
<b>26 AWG 7/34 Overcoated Tinned Copper</b>				
2	.100 [2.54]	.200 [5.08]	.039 [0.99]	57745-2
5	.400 [10.16]	.500 [12.70]	.039 [0.99]	57745-5
10	.900 [22.86]	1.000 [25.40]	.039 [0.99]	1-57745-0
15	1.400 [35.56]	1.500 [38.10]	.039 [0.99]	1-57745-5
20	1.900 [48.26]	2.000 [50.80]	.039 [0.99]	2-57745-0
25	2.400 [60.96]	2.500 [63.50]	.039 [0.99]	2-57745-5
28	2.700 [68.58]	2.800 [71.12]	.039 [0.99]	2-57745-8

No. of Conductors	Dimensions			Part Number
	A	B	C	
<b>24 AWG 7/32 Overcoated Tinned Copper</b>				
2	.100 [2.54]	.200 [5.08]	.044 [1.12]	57747-2
5	.400 [10.16]	.500 [12.70]	.044 [1.12]	57747-5
10	.900 [22.86]	1.000 [25.40]	.044 [1.12]	1-57747-0
15	1.400 [35.56]	1.500 [38.10]	.044 [1.12]	1-57747-5
20	1.900 [48.26]	2.000 [50.80]	.044 [1.12]	2-57747-0
25	2.400 [60.96]	2.500 [63.50]	.044 [1.12]	2-57747-5
28	2.700 [68.58]	2.800 [71.12]	.044 [1.12]	2-57747-8
<b>22 AWG 7/30 Tinned Copper</b>				
2	.100 [2.54]	.200 [5.08]	.051 [1.30]	57748-2
5	.400 [10.16]	.500 [12.70]	.051 [1.30]	57748-5
10	.900 [22.86]	1.000 [25.40]	.051 [1.30]	1-57748-0
15	1.400 [35.56]	1.500 [38.10]	.051 [1.30]	1-57748-5
20	1.900 [48.26]	2.000 [50.80]	.051 [1.30]	2-57748-0
25	2.400 [60.96]	2.500 [63.50]	.051 [1.30]	2-57748-5
28	2.700 [68.58]	2.800 [71.12]	.051 [1.30]	2-57748-8

Other Conductor Counts Available on Request.

Contact MADISON CABLE (1-877-MADISON), a Division of TE, for engineering questions or for order placement of this cable.

**Cable Solutions** (Continued)

**.156 [3.96] Centerline,  
Flat Ribbon Cable,  
PVC Insulation**

**Product Specifications**

**Voltage Rating** — 300 Volts  
**UL Recognized** — AWM Style 2651  
**CSA** — Available on request

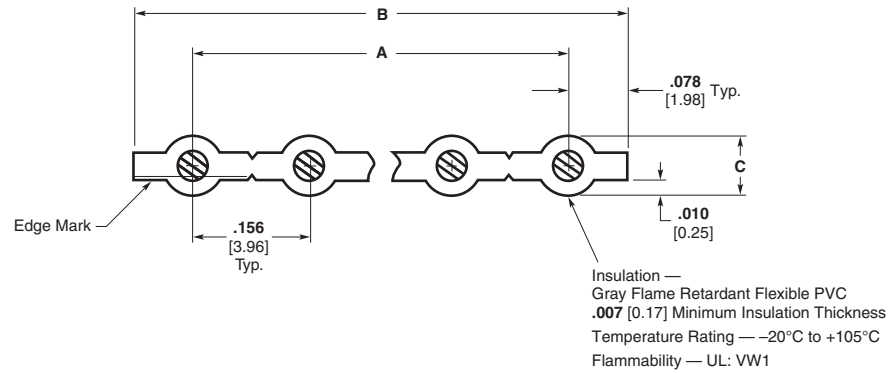

No. of Conductors	Dimensions			Part Number
	A	B	C	
<b>22 AWG 7/30 Tinned Copper</b>				
2	.156 [3.96]	.312 [7.92]	.051 [1.30]	57750-2
5	.624 [15.85]	.780 [19.81]	.051 [1.30]	57750-5
10	1.404 [35.66]	1.560 [39.62]	.051 [1.30]	1-57750-0
15	2.184 [55.47]	2.340 [59.44]	.051 [1.30]	1-57750-5
20	2.964 [75.29]	3.120 [79.25]	.051 [1.30]	2-57750-0
24	3.588 [91.14]	3.744 [95.10]	.051 [1.30]	2-57750-4
<b>18 AWG 7/26 Tinned Copper</b>				
2	.156 [3.96]	.312 [7.92]	.068 [1.73]	57752-2
5	.624 [15.85]	.780 [19.81]	.068 [1.73]	57752-5
10	1.404 [35.66]	1.560 [39.62]	.068 [1.73]	1-57752-0
15	2.184 [55.47]	2.340 [59.44]	.068 [1.73]	1-57752-5
20	2.964 [75.29]	3.120 [79.25]	.068 [1.73]	2-57752-0
24	3.588 [91.14]	3.744 [95.10]	.068 [1.73]	2-57752-4

Other Conductor Counts Available on Request.

Contact MADISON CABLE (1-877-MADISON), a Division of TE, for engineering questions or for order placement of this cable.

## Part Number Index

**Note:** This index lists all cataloged parts by base no. only. Complete part nos. (with prefixes and/or suffixes) are shown on the page(s) indicated.

Part No.	Page	Part No.	Page	Part No.	Page
19156	86	188275	36	1761608	80
57034	47	188431	41	1761609	81
57040	47	215079	32, 33, 34	1761685	82
57744	97	215083	38	1761686	82
57745	97	215083	32, 33, 38	1761687	82
57746	97	215460	35	1761688	82
57747	97	215460	32, 33, 35	1761690	83
57748	97	215464	32, 33, 37	1761692	83
57750	98	215570	32, 33, 39	1761693	82
57752	98	338068	41	1761694	82
100411	41	338069	41	1825851	96
102142	92	338070	41	1888188	15
102198	86	338095	32, 33, 40	5088450	66
102312	96	338096	32, 33, 40	5102153	85
102320	96	338097	32, 33, 40	5102154	85
104068	9, 10	338728	41	5102155	85
104069	9, 11	499252	14, 49, 50, 51, 68	5102156	85
104069	11	499712	65	5102159	90
104072	65	499726	92	5102160	90
104652	20	499991	63	5102161	90
104655	21	746383	86	5102162	90
104656	21	746603	47	5102321	85
104693	21	746610	58	5102322	90
104891	27	746611	59	5103308	76
104892	26	1377074	44	5103309	76
104893	26	1437006	56	5103310	77
104894	24	1437011	69	5103311	77
104895	24	1437020	67	5104338	78
111196	9	1437021	67	5104340	79
111293	96	1437022	67	5111008	95
111338	96	1437023	64, 69	5111105	95
111382	58	1437024	69	5111448	46
111446	45	1437025	69	5111595	12
111451	63	1437026	69	5111824	15
111492	45	1437027	69	5499141	90
111494	46	1437028	69	5499160	85
111504	45	1437029	69	5499206	85
111506	46	1499252	68	5499345	90
111547	67	1658525	57	5499374	85
111614	68	1658526	55	5499376	90
111620	64	1658527	53	5499786	90
111623	17	1658528	53	5499910	85
111626	17	1658618	14	5499911	85
120623	63	1658619	14	5499913	90
147121	21	1658620	49	5499914	90
147381	21	1658621	50	5499922	85
147382	21	1658622	50	5499923	85
147383	21	1658623	49	5499925	90
147384	20	1658624	51	5746612	59
147413	20	1658694	88	5746613	59
147503	21	1658695	88	5746615	60
174638	62	1734161	15	6437006	61
174903	62	1734162	15	6489700	15
175629	62	1761606	80		
175637	62	1761607	81		

**te.com**

© 2012 Tyco Electronics Corporation, a TE Connectivity Ltd. Company. All Rights Reserved.  
82012 LUG PDF 04/2012  
TE Connectivity and the TE connectivity (logo) are trademarks. Other logos, product and/or  
company names might be trademarks of their respective owners.



Компания «Life Electronics» занимается поставками электронных компонентов импортного и отечественного производства от производителей и со складов крупных дистрибьюторов Европы, Америки и Азии.

С конца 2013 года компания активно расширяет линейку поставок компонентов по направлению коаксиальный кабель, кварцевые генераторы и конденсаторы (керамические, пленочные, электролитические), за счёт заключения дистрибьюторских договоров

Мы предлагаем:

- Конкурентоспособные цены и скидки постоянным клиентам.
- Специальные условия для постоянных клиентов.
- Подбор аналогов.
- Поставку компонентов в любых объемах, удовлетворяющих вашим потребностям.
- Приемлемые сроки поставки, возможна ускоренная поставка.
- Доставку товара в любую точку России и стран СНГ.
- Комплексную поставку.
- Работу по проектам и поставку образцов.
- Формирование склада под заказчика.
- Сертификаты соответствия на поставляемую продукцию (по желанию клиента).
- Тестирование поставляемой продукции.
- Поставку компонентов, требующих военную и космическую приемку.
- Входной контроль качества.
- Наличие сертификата ISO.

В составе нашей компании организован Конструкторский отдел, призванный помогать разработчикам, и инженерам.

Конструкторский отдел помогает осуществить:

- Регистрацию проекта у производителя компонентов.
- Техническую поддержку проекта.
- Защиту от снятия компонента с производства.
- Оценку стоимости проекта по компонентам.
- Изготовление тестовой платы монтаж и пусконаладочные работы.



Тел: +7 (812) 336 43 04 (многоканальный)  
Email: org@lifeelectronics.ru