

# D-DF

D-Sub connectors - Screw-machined Contacts

## FIXED MACHINED CONTACT CONNECTOR



CHARACTERISTICS

### Specifications

- Connectors according to MIL C24308 - NFC93425-HE5

Materials and Platings	
<b>Shells</b>	Steel tinned with dimples on plug connector
<b>Insulator</b>	Glass-filled thermoplastic, UL 94V-0
<b>Rear insert</b>	Brass, 3µm up to 5µm (118µ" up to 197µ") tinned over nickel 2µm up to 3µm (78µ" up to 118µ")
<b>Boardlock</b>	Tin plating 4µm up to 6µm (157µ" up to 236µ") over nickel 2µm up to 3µm (78µ" up to 118µ")
<b>Screwlock</b>	Brass, 6µm up to 10µm (236µ" up to 394µ") tinned over nickel 2µm up to 3µm (78µ" up to 118µ")
<b>Contacts</b>	<b>D:</b> brass <b>DF:</b> pin = brass socket = copper alloy <b>Right angle version:</b> full gold plating over 2µm to 3µm nickel <b>Straight version:</b> full gold plating over 2µm up to 3µm (78µ" up to 118µ") nickel

Electrical Data	
<b>Current rating</b>	7.5A
<b>Voltage rating</b>	300V AC/rms 50Hz
<b>Withstanding voltage</b>	1000V AC/rms 50Hz for one minute
<b>Insulation resistance</b>	5000MΩ
<b>Contact resistance</b>	<b>D:</b> 8.5mΩ max <b>DF:</b> 5mΩ max

Climatic Data	
<b>Operating temperature</b>	<b>D / DF:</b> -55°C to + 125°C
<b>Salt spray</b>	48 hours
<b>Humidity</b>	<b>D:</b> 21 days (40°C - 95% HR) <b>DF:</b> 56 days (40°C - 95% HR)

Mechanical Data		
<b>Mating and unmating force</b>		
Unit: kg ( lb)		
No. of Cts	Mate (max)	Unmate (min)
9 (size E)	3.05 (6.74)	0.36 (0.79)
15 (size A)	5.09 (11.24)	0.46 (1.01)
25 (size B)	8.44 (18.66)	0.81 (1.8)
37 (size C)	12.51 (27.65)	1.1 (2.47)
50 (size D)	14.65 (32.38)	1.6 (3.56)

DESCRIPTION

Amphenol's 17D and 17DF series fixed contact D-Subminiature connector is suitable for industrial or telecom use.

The machined contact provide stability and reliability.

This series offers the broadest range of termination options in the Amphenol line.

*Connectors  
for industrial  
and  
telecom use*

APPLICATIONS

- Medical
- Industrial
- Telecom
- Any industry standard I / O connections



**Amphenol**

D-DF / E18

## Shell size dimensions

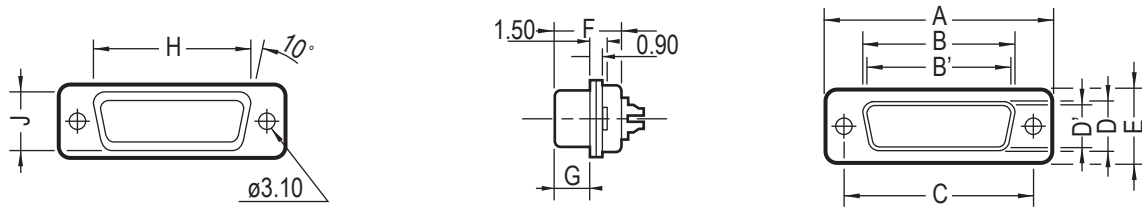

Shell size	Contact P: Pin S: Socket	A ±0.25 (±.010)	B 0/-0.20 (0/- .008)	B' +0.20/0 (+.008/0)	C ±0.10 (±.004)	D 0/-0.25 (0/- .010)	D' +0.25/0 (+.010/0)	E ±0.20 (±.008)	F +0.05/-0.20 (+.002/- .008)	F' +0.10/-0.20 (+.004/- .008)	G +0.10/-0.20 (+.004/- .008)	G' ±0.10 (±.004)	H +0.10/-0.40 (+.004/- .016)	J 0/-0.50 (0/- .020)
E	P	30.7 (1.209")		16.8 (.661")	25.0 (.984")		8.2 (.323")	12.4 (.488")		10.9 (.429")		5.9 (.232")	19.4 (.764")	11.0 (.433")
	S		16.4 (.646")			8.0 (.315")			11.1 (.437")		6.2 (.244")			
A	P	39.0 (1.535")		25.1 (.988")	33.3 (1.311")		8.2 (.323")	12.4 (.488")		10.9 (.429")		5.9 (.232")	27.7 (1.091")	11.0 (.433")
	S		24.8 (.976")			8.0 (.315")			11.1 (.437")		6.2 (.244")			
B	P	52.9 (2.083")		38.8 (1.528")	47.0 (1.850")		8.2 (.323")	12.4 (.488")		11.0 (.433")		5.8 (.228")	41.4 (1.630")	11.0 (.433")
	S		38.5 (1.513")			8.0 (.315")			11.1 (.437")		6.2 (.244")			
C	P	69.2 (2.724")		55.3 (2.177")	63.5 (2.500")		8.2 (.323")	12.4 (.488")		11.0 (.433")		5.8 (.228")	57.9 (2.280")	11.0 (.433")
	S		54.9 (2.161")			8.0 (.315")			11.1 (.437")		6.2 (.244")			
D	P	66.8 (2.630")		52.7 (2.075")	61.1 (2.406")		11.0 (.433")	15.2 (.598")		11.0 (.433")		5.8 (.228")	55.5 (2.185")	13.8 (.543")
	S		52.5 (2.067")			10.9 (.429")			11.1 (.437")		6.2 (.244")			

## Panel cutouts

Optimal cutout for rear mounting

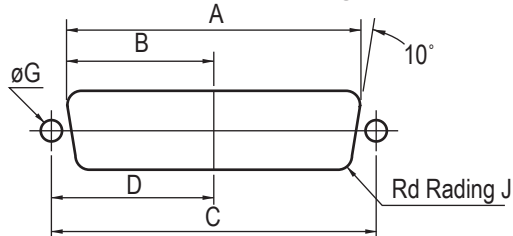

Standard cutout

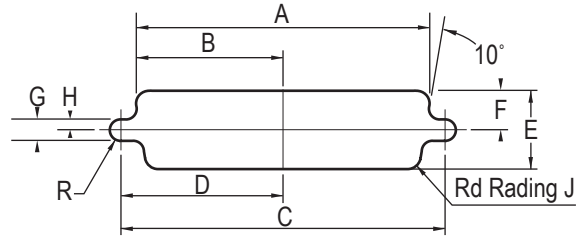

Shell size	Mounting method	A ±0.20 (±.008)	B ±0.20 (±.008)	C ±0.20 (±.008)	D ±0.20 (±.008)	E ±0.20 (±.008)	F ±0.20 (±.008)	G ±0.20 (±.008)	H ±0.20 (±.008)	J ±0.20 (±.008)
E	Front	22.2 (.874")	11.1 (.437")	25.0 (.984")	12.5 (.492")	13.0 (.512")	6.5 (.256")	3.0 (.118")	1.5 (.059")	2.1 (.083")
	Rear	20.5 (.807")	10.2 (.402")							
A	Front	30.5 (1.201")	15.3 (.602")	33.3 (1.311")	16.7 (.657")	13.0 (.512")	6.5 (.256")	3.0 (.118")	1.5 (.059")	2.1 (.083")
	Rear	28.8 (1.134")	14.4 (.567")							
B	Front	44.3 (1.744")	22.1 (.870")	47.0 (1.850")	23.5 (.925")	13.0 (.512")	6.5 (.256")	3.0 (.118")	1.5 (.059")	2.1 (.083")
	Rear	42.5 (1.673")	21.3 (.839")							
C	Front	60.7 (2.390")	30.4 (1.197")	63.5 (2.500")	31.7 (1.248")	13.0 (.512")	6.5 (.256")	3.0 (.118")	1.5 (.059")	2.1 (.083")
	Rear	59.1 (2.327")	29.5 (1.161")							
D	Front	58.3 (2.295")	29.2 (1.150")	61.1 (2.406")	30.6 (1.205")	15.8 (.622")	7.9 (.311")	3.0 (.118")	1.5 (.059")	2.1 (.083")
	Rear	56.3 (2.217")	28.2 (1.110")							

# Termination

## Right angle

### MIL Footprint

without bracket:



C



A4

plastic bracket:



AJ3



AJ4

metal bracket:



A



AM4: A=13.2mm  
AZ4: A=11.5mm

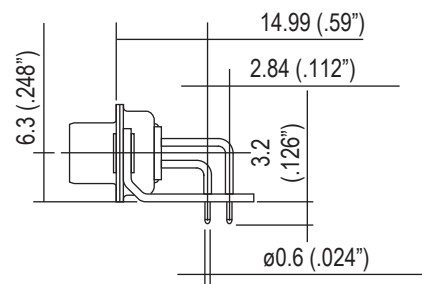

AM4B

50 contacts:



# Termination

## European footprint

without bracket:



**1AON: X=2.54mm**  
**1BON: X=2.84mm**

plastic bracket:



**1APN: X=2.54mm**  
**1BPN: X=2.84mm**



**1AUN: X=2.54mm**  
**1BUN: X=2.84mm**

metal bracket:



**1AMN: X=2.54mm**  
**1BMN: X=2.84mm**

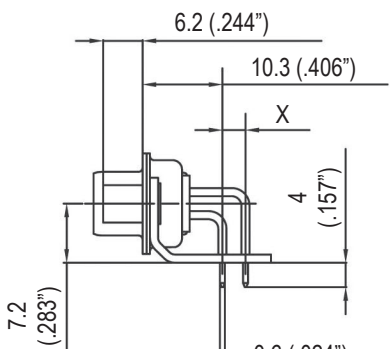

**1ATN: X=2.54mm**  
**1BTN: X=2.84mm**

50 contacts:



## Termination

### Solder Cup:



### Wire Wrap:



termination	Nb of wraps	L
<b>F179</b>	2	9.6mm (.378")
<b>F179A</b>	3	13mm (.512")

### Straight PCB:

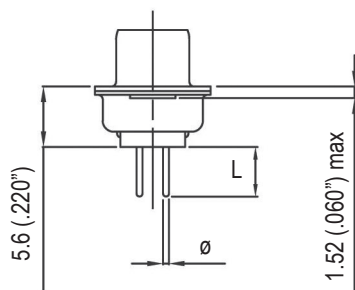

termination	$\varnothing$	L
<b>U</b>	0.6mm (.024")	3.2mm (.126")
<b>V</b>	1.02mm (.040")	2.4mm (.095")
<b>T</b>	0.6mm (.024")	4mm (.157")
<b>OL2</b>	0.6mm (.024")	5.5mm (.217")

### Grounding tabs:

#### For straight termination



**RM5**

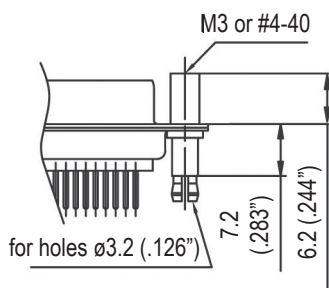

**RM8**

#### For R/A termination

#### FOR PCB 1.6



**RM6**

## Panel mounting option

For straight and R/A termination



Standard rivet 3.1mm  
**no digit**

Float mounting  
**F**

Threaded rear insert  
**H / G**



Fixed front female screwlock  
**VF / VFM**

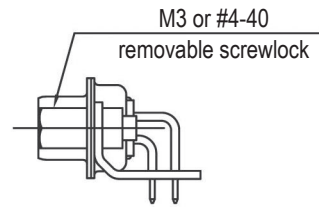

Removable female screwlock  
**VF2 / VFM2**

## Recommended PCB Layout



For straight PCB: X = 2.84mm (.112")

For right angle PCB: MIL: X = 2.84mm (.112")

European: X = 2.54mm (.100"), 2.84mm in option

	size E	size A	size B	size C	size D
<b>C±0,1 (.004)</b>	25 (.984)	33.3 (1.311)	47 (1.85)	63.5 (2.5)	61.1 (2.406)
<b>F±0,05 (.002)</b>	10.96 (.431)	19.18 (.755)	33.12 (1.304)	49.68 (1.956)	44.2 (1.74)

# How to order



**For special request, please consult factory**





Компания «Life Electronics» занимается поставками электронных компонентов импортного и отечественного производства от производителей и со складов крупных дистрибьюторов Европы, Америки и Азии.

С конца 2013 года компания активно расширяет линейку поставок компонентов по направлению коаксиальный кабель, кварцевые генераторы и конденсаторы (керамические, пленочные, электролитические), за счёт заключения дистрибьюторских договоров

Мы предлагаем:

- Конкурентоспособные цены и скидки постоянным клиентам.
- Специальные условия для постоянных клиентов.
- Подбор аналогов.
- Поставку компонентов в любых объемах, удовлетворяющих вашим потребностям.
- Приемлемые сроки поставки, возможна ускоренная поставка.
- Доставку товара в любую точку России и стран СНГ.
- Комплексную поставку.
- Работу по проектам и поставку образцов.
- Формирование склада под заказчика.
- Сертификаты соответствия на поставляемую продукцию (по желанию клиента).
- Тестирование поставляемой продукции.
- Поставку компонентов, требующих военную и космическую приемку.
- Входной контроль качества.
- Наличие сертификата ISO.

В составе нашей компании организован Конструкторский отдел, призванный помогать разработчикам, и инженерам.

Конструкторский отдел помогает осуществить:

- Регистрацию проекта у производителя компонентов.
- Техническую поддержку проекта.
- Защиту от снятия компонента с производства.
- Оценку стоимости проекта по компонентам.
- Изготовление тестовой платы монтаж и пусконаладочные работы.



Тел: +7 (812) 336 43 04 (многоканальный)  
Email: [org@lifeelectronics.ru](mailto:org@lifeelectronics.ru)