

# Precision 300MHz to 7GHz RF Detector with Shutdown and Offset Adjustment

## FEATURES

- Temperature Compensated Internal Schottky Diode RF Detector
- Wide Input Frequency Range: 300MHz to 7GHz\*
- Wide Input Power Range: -32dBm to 10dBm
- Buffered Detector Output
- Precision  $V_{OUT}$  Offset Control
- Wide  $V_{CC}$  Range of 2.7V to 6V
- Low Operating Current: 500 $\mu$ A
- Low Shutdown Current: <2 $\mu$ A
- Available in a Low Profile (1mm) SOT-23 Package

## APPLICATIONS

- 802.11a, 802.11b, 802.11g, 802.15, 802.16
- Multimode Mobile Phone Products
- Optical Data Links
- Wireless Data Modems
- Wireless and Cable Infrastructure
- RF Power Alarm
- Envelope Detector

## DESCRIPTION

The LTC<sup>®</sup>5531 is an RF power detector for RF applications operating in the 300MHz to 7GHz range. A temperature compensated Schottky diode peak detector and buffer amplifier are combined in a small ThinSOT<sup>™</sup> package. The supply voltage range is optimized for operation from a single lithium-ion cell or 3xNiMH.

The RF input voltage is peak detected using an on-chip Schottky diode. The detected voltage is buffered and supplied to the  $V_{OUT}$  pin. A power saving shutdown mode reduces current to less than 2 $\mu$ A. The initial offset voltage of 120mV  $\pm$ 35mV can be precisely adjusted using the  $V_{OS}$  pin.

The LTC5531 operates with input power levels from -32dBm to 10dBm.

**LT**, LTC and LT are registered trademarks of Linear Technology Corporation. ThinSOT is a trademark of Linear Technology Corporation.

\*Higher frequency operation is achievable with reduced performance. Consult factory for more information.

## TYPICAL APPLICATION

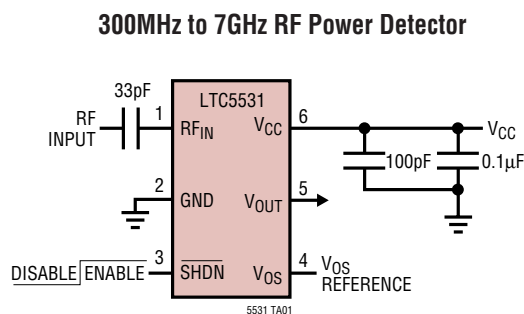

**$V_{OUT}$  Output Voltage vs RF Input Power**

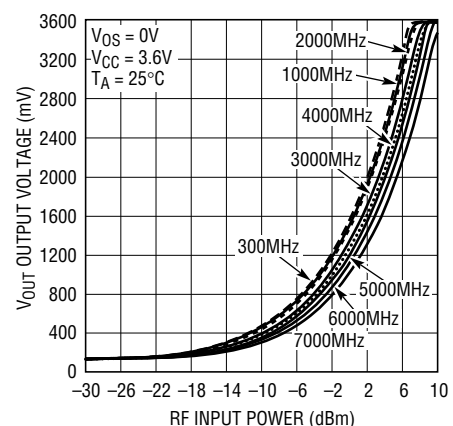

5531 TA02

## ABSOLUTE MAXIMUM RATINGS

(Note 1)

$V_{CC}$ , $V_{OUT}$ , $\overline{SHDN}$ , $V_{OS}$ .....	-0.3V to 6.5V
RF <sub>IN</sub> Voltage .....	( $V_{CC} \pm 1.5V$ ) to 7V
RF <sub>IN</sub> Power (RMS) .....	12dBm
$I_{VOUT}$ .....	5mA
Operating Temperature Range (Note 2) ..	-40°C to 85°C
Maximum Junction Temperature .....	125°C
Storage Temperature Range .....	-65°C to 150°C
Lead Temperature (Soldering, 10 sec) .....	300°C

## PACKAGE/ORDER INFORMATION

	ORDER PART NUMBER
	LTC5531ES6
	S6 PART MARKING
	LTBBQ

Consult LTC Marketing for parts specified with wider operating temperature ranges.

## ELECTRICAL CHARACTERISTICS

The ● denotes the specifications which apply over the full operating temperature range, otherwise specifications are at  $T_A = 25^\circ\text{C}$ .  $V_{CC} = 3.6\text{V}$ ,  $\overline{SHDN} = V_{CC} = \text{HI}$ ,  $\overline{SHDN} = 0\text{V} = \text{LO}$ , RF Input Signal is Off,  $V_{OS} = 0\text{V}$  and  $\overline{SHDN} = \text{HI}$  unless otherwise noted.

PARAMETER	CONDITIONS	MIN	TYP	MAX	UNITS
$V_{CC}$ Operating Voltage		● 2.7		6	V
$I_{VCC}$ Operating Current	$I_{VOUT} = 0\text{mA}$	●	0.5	0.7	mA
$I_{VCC}$ Shutdown Current	$\overline{SHDN} = \text{LO}$	●	0.01	2	$\mu\text{A}$
$V_{OUT}$ (No RF Input)	$R_{LOAD} = 2\text{k}$ , $V_{OS} = 0\text{V}$ $\overline{SHDN} = \text{LO}$	●	85	100 to 140 1	mV mV
$V_{OUT}$ Output Current	$V_{OUT} = 1.75\text{V}$ , $V_{CC} = 2.7\text{V}$ , $\Delta V_{OUT} < 10\text{mV}$	●	2	4	mA
$V_{OUT}$ Enable Time	$\overline{SHDN} = \text{LO to HI}$ , $C_{LOAD} = 33\text{pF}$ , $R_{LOAD} = 2\text{k}$	●	8	20	$\mu\text{s}$
$V_{OUT}$ Bandwidth	$C_{LOAD} = 33\text{pF}$ , $R_{LOAD} = 2\text{k}$ (Note 4)		2		MHz
$V_{OUT}$ Load Capacitance	(Notes 6, 7)	●		33	pF
$V_{OUT}$ Slew Rate	$V_{RFIN} = 1\text{V Step}$ , $C_{LOAD} = 33\text{pF}$ , $R_{LOAD} = 2\text{k}$ (Note 3)		3		V/ $\mu\text{s}$
$V_{OUT}$ Noise	$V_{CC} = 3\text{V}$ , Noise BW = 1.5MHz, 50 $\Omega$ RF Input Termination		1		mV <sub>P-P</sub>
$V_{OS}$ Voltage Range		●	0	1	V
$V_{OS}$ Input Current		●	-0.5	0.5	$\mu\text{A}$
$\overline{SHDN}$ Voltage, Chip Disabled	$V_{CC} = 2.7\text{V to } 6\text{V}$	●		0.35	V
$\overline{SHDN}$ Voltage, Chip Enabled	$V_{CC} = 2.7\text{V to } 6\text{V}$	●	1.4		V
SHDN Input Current	SHDN = 3.6V	●	22	36	$\mu\text{A}$
RF <sub>IN</sub> Input Frequency Range	(Note 8)		300 to 7000		MHz
RF <sub>IN</sub> Input Power Range	RF Frequency = 300MHz to 7GHz (Note 5, 6) $V_{CC} = 2.7\text{V to } 6\text{V}$		-32 to 10		dBm
RF <sub>IN</sub> AC Input Resistance	F = 1000MHz, Pin = -25dBm		220		$\Omega$
RF <sub>IN</sub> Input Shunt Capacitance	F = 1000MHz, Pin = -25dBm		0.65		pF

**Note 1:** Absolute Maximum Ratings are those values beyond which the life of a device may be impaired.

**Note 2:** Specifications over the -40°C to 85°C operating temperature range are assured by design, characterization and correlation with statistical process controls.

**Note 3:** The rise time at  $V_{OUT}$  is measured between 1.3V and 2.3V.

**Note 4:** Bandwidth is calculated based on the 10% to 90% rise time

equation:  $BW = 0.35/\text{rise time}$ .

**Note 5:** RF performance is tested at 1800MHz

**Note 6:** Guaranteed by design.

**Note 7:** Capacitive loading greater than this value may result in circuit instability.

**Note 8:** Higher frequency operation is achievable with reduced performance. Consult factory for more information.

# TYPICAL PERFORMANCE CHARACTERISTICS

**V<sub>OUT</sub> Output Voltage vs V<sub>CC</sub> Supply Voltage (RF Input Signal Off)**

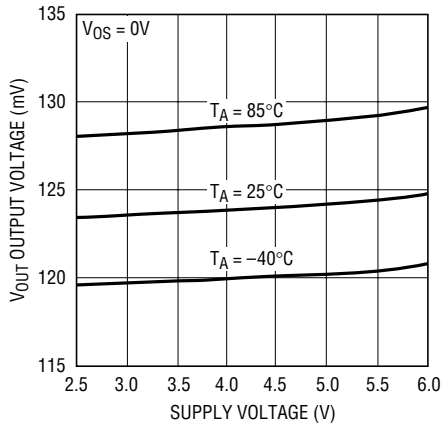

5531 G01

**I<sub>CC</sub> Power Supply Current vs V<sub>CC</sub> Supply Voltage (RF Input Signal Off)**

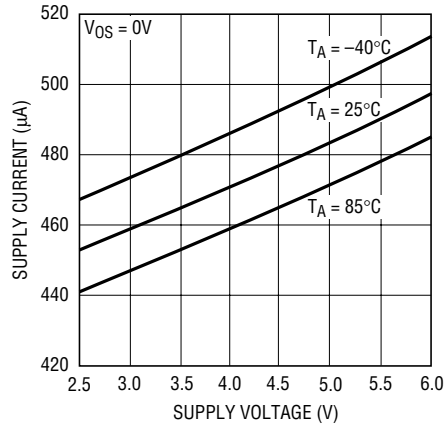

5531 G02

**V<sub>OUT</sub> vs RF Input Power and V<sub>OS</sub>, f<sub>RF</sub> = 300MHz**

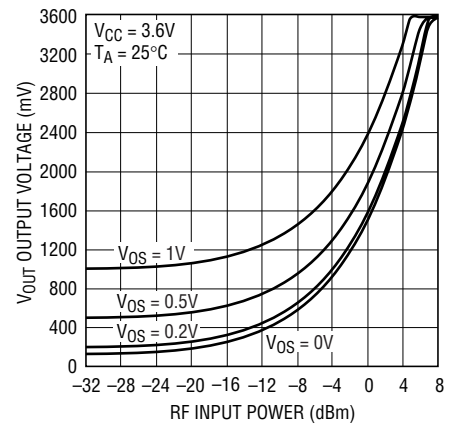

5531 G03

**V<sub>OUT</sub> vs RF Input Power and V<sub>OS</sub>, f<sub>RF</sub> = 1000MHz**

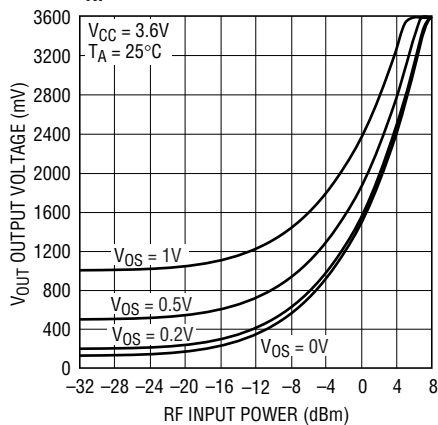

5531 G04

**V<sub>OUT</sub> vs RF Input Power and V<sub>CC</sub> Supply Voltage, f<sub>RF</sub> = 1000MHz**

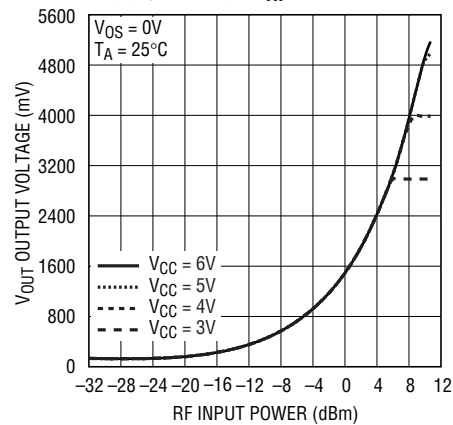

5531 G05

**Typical Detector Characteristics, 300MHz**

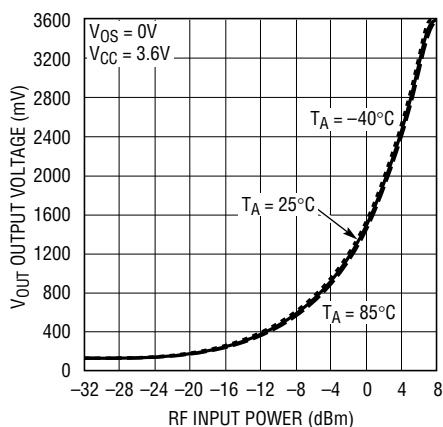

5531 G06

**Typical Detector Characteristics, 1000MHz**

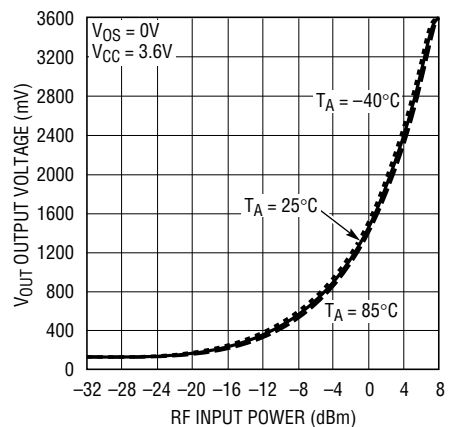

5531 G07

# TYPICAL PERFORMANCE CHARACTERISTICS

**Typical Detector Characteristics, 2000MHz**

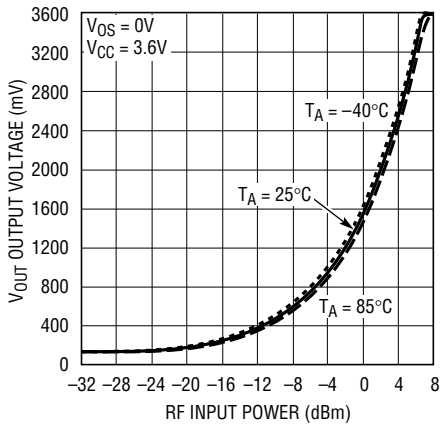

**Typical Detector Characteristics, 3000MHz**

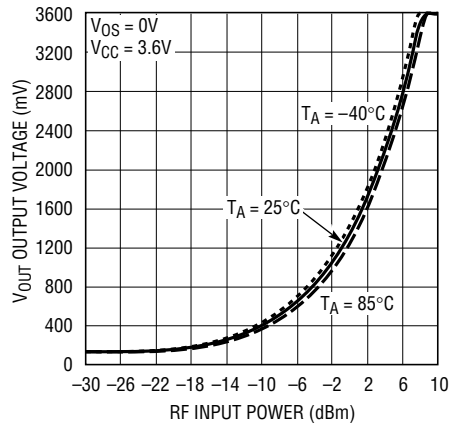

**Typical Detector Characteristics, 4000MHz**

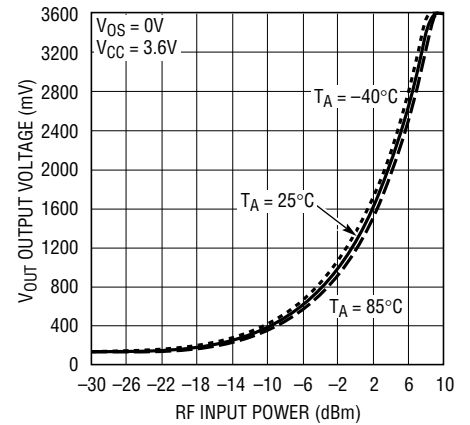

**Typical Detector Characteristics, 5000MHz**

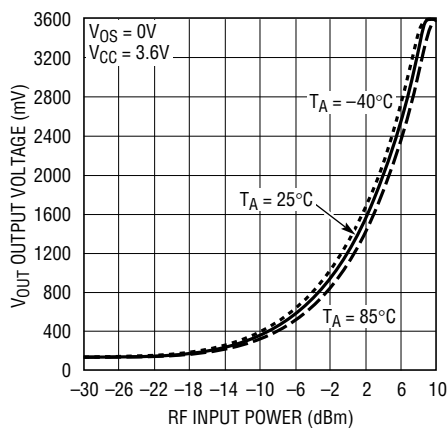

**Typical Detector Characteristics, 6000MHz**

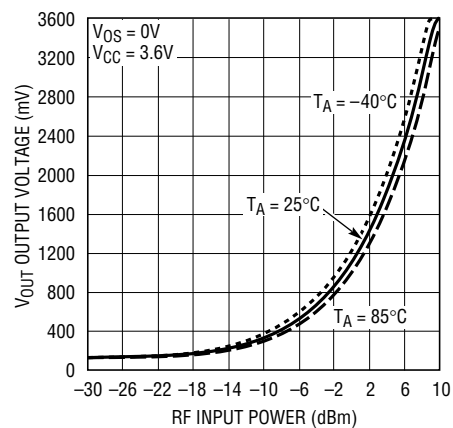

**Typical Detector Characteristics, 7000MHz**

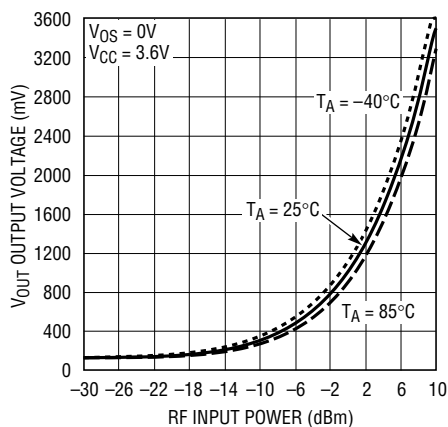

**V<sub>OUT</sub> Slope vs RF Input Power at 300MHz**

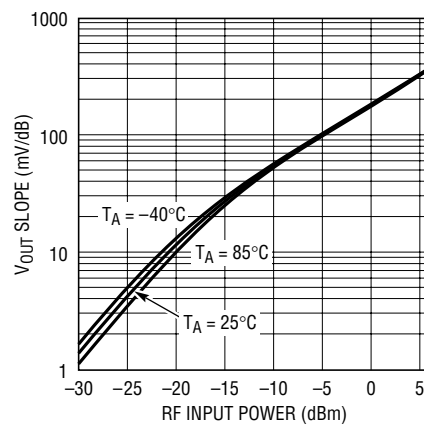

# TYPICAL PERFORMANCE CHARACTERISTICS

**V<sub>OUT</sub> Slope vs RF Input Power at 1000MHz**

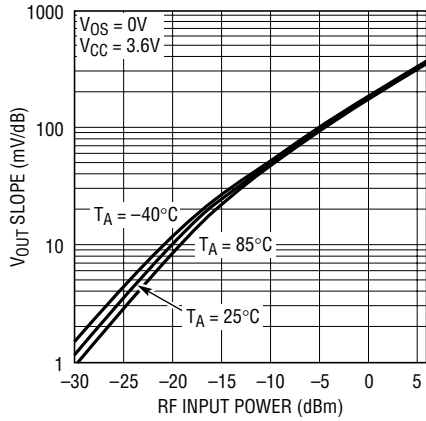

5531 G15

**V<sub>OUT</sub> Slope vs RF Input Power at 2000MHz**

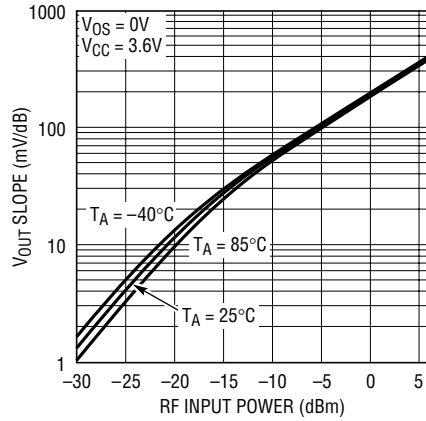

5531 G16

**V<sub>OUT</sub> Slope vs RF Input Power at 3000MHz**

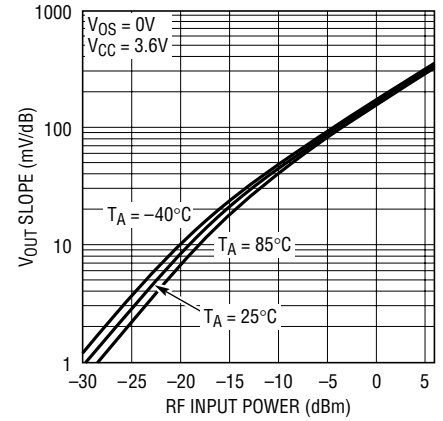

5531 G17

**V<sub>OUT</sub> Slope vs RF Input Power at 4000MHz**

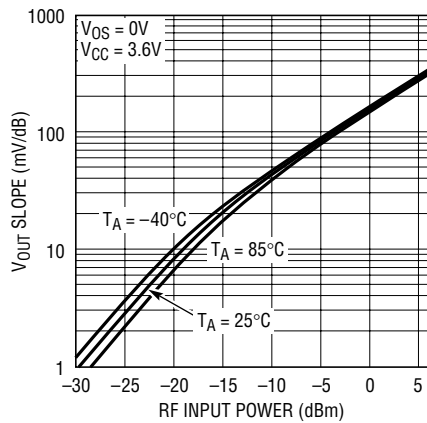

5531 G18

**V<sub>OUT</sub> Slope vs RF Input Power at 5000MHz**

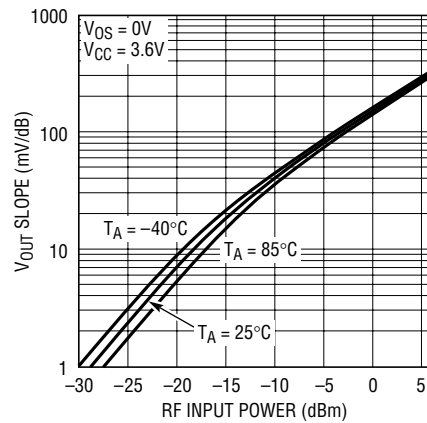

5531 G19

**V<sub>OUT</sub> Slope vs RF Input Power at 6000MHz**

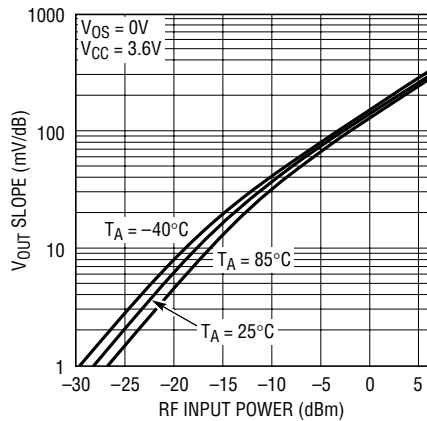

5531 G20

**V<sub>OUT</sub> Slope vs RF Input Power at 7000MHz**

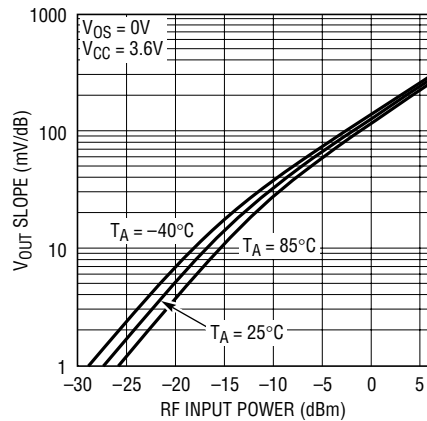

5531 G21

## TYPICAL PERFORMANCE CHARACTERISTICS

RF<sub>IN</sub> Input Impedance (P<sub>in</sub> = 0dBm, V<sub>CC</sub> = 3.6V, T<sub>A</sub> = 25°C)

FREQUENCY (GHz)	RESISTANCE (Ω)	REACTANCE (Ω)
0.30	290.45	-136.22
0.50	234.41	-162.54
0.70	178.25	-170.53
0.90	137.31	-159.89
1.10	109.17	-147.57
1.30	86.30	-136.18
1.50	68.65	-121.74
1.70	57.48	-107.60
1.90	49.79	-96.72
2.10	43.56	-86.70
2.30	38.67	-77.91
2.50	34.82	-70.13
2.70	31.68	-62.86
2.90	29.13	-56.01
3.10	27.17	-49.83
3.30	25.73	-44.24
3.50	24.56	-39.74
3.70	23.18	-35.35
3.90	22.31	-30.62
4.10	20.73	-26.88
4.30	19.88	-22.31
4.50	19.40	-18.23
4.70	19.05	-14.25
4.90	19.08	-10.21
5.10	19.55	-6.30
5.30	20.85	-2.84
5.50	21.94	-1.49
5.70	20.60	-0.07
5.90	19.29	2.99
6.10	18.69	6.61
6.30	18.53	10.39
6.50	18.74	14.35
6.70	19.79	17.91
6.90	19.75	20.77
7.00	19.99	22.47

S11 Forward Reflection Impedance

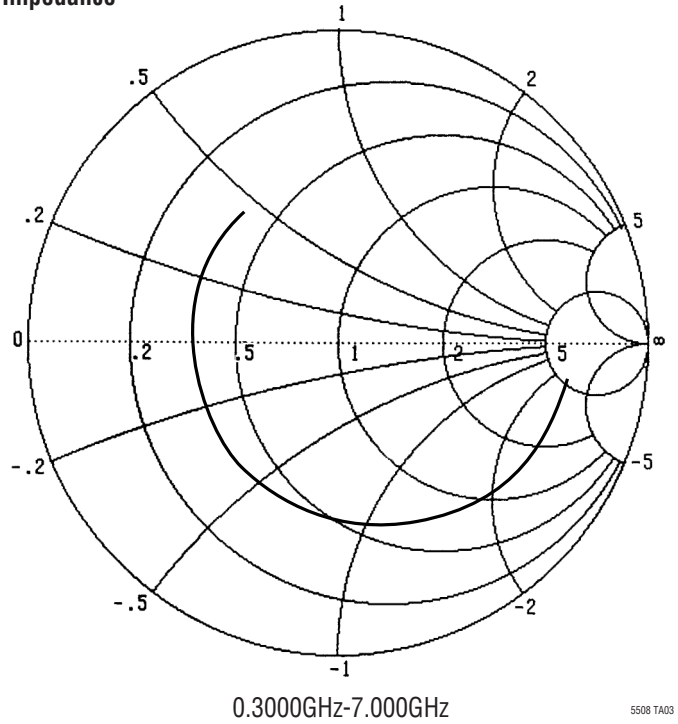

5508 TA03

## TYPICAL PERFORMANCE CHARACTERISTICS

RF<sub>IN</sub> Input Impedance (P<sub>in</sub> = -25dBm, V<sub>CC</sub> = 3.6V, T<sub>A</sub> = 25°C)

FREQUENCY (GHz)	RESISTANCE (Ω)	REACTANCE (Ω)
0.30	216.45	-76.47
0.50	190.63	-98.28
0.70	161.98	-112.03
0.90	133.17	-111.53
1.10	113.08	-109.05
1.30	94.55	-107.08
1.50	75.33	-98.50
1.70	63.52	-88.19
1.90	55.19	-80.05
2.10	48.64	-72.23
2.30	43.73	-64.81
2.50	39.71	-58.31
2.70	36.47	-52.27
2.90	33.69	-46.77
3.10	31.61	-41.25
3.30	29.78	-36.61
3.50	28.27	-32.39
3.70	26.63	-28.12
3.90	26.12	-23.97
4.10	24.20	-20.75
4.30	23.28	-16.69
4.50	22.60	-12.77
4.70	22.21	-9.08
4.90	22.15	-5.24
5.10	22.61	-1.58
5.30	23.90	1.53
5.50	24.97	2.62
5.70	23.51	4.00
5.90	22.25	6.94
6.10	21.57	10.62
6.30	21.43	14.02
6.50	21.69	17.77
6.70	22.68	21.24
6.90	22.81	24.21
7.00	23.07	25.56

S11 Forward Reflection  
Impedance

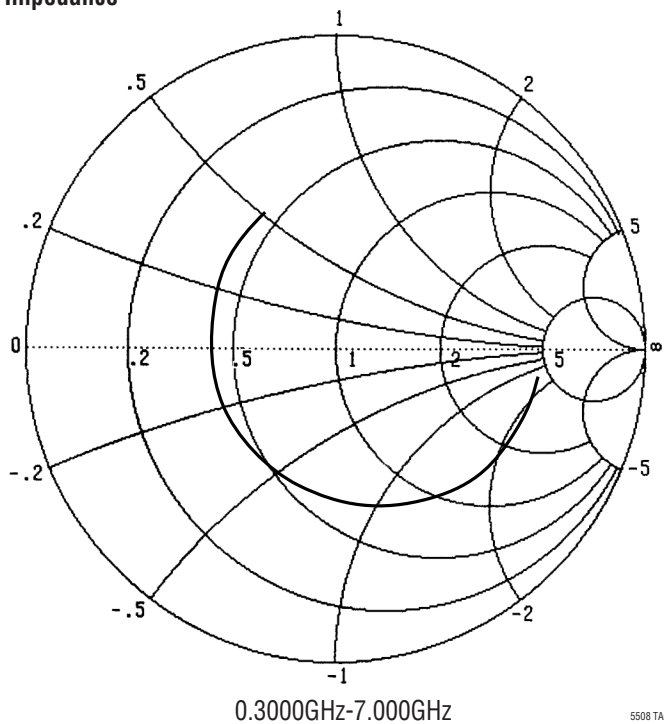

5508 TA04

## PIN FUNCTIONS

**RF<sub>IN</sub> (Pin 1):** RF Input Voltage. Referenced to V<sub>CC</sub>. A coupling capacitor must be used to connect to the RF signal source. The frequency range is 300MHz to 7GHz. This pin has an internal 500Ω termination, an internal Schottky diode detector and a peak detector capacitor.

**GND (Pin 2):** Ground.

**SHDN (Pin 3):** Shutdown Input. A logic low on the SHDN pin places the part in shutdown mode. A logic high enables the part. SHDN has an internal 160k pulldown resistor to ensure that the part is in shutdown when no input is

applied. In shutdown V<sub>OUT</sub> is connected to ground via a 280Ω resistor.

**V<sub>OS</sub> (Pin 4):** V<sub>OUT</sub> Offset Voltage Adjustment. This pin adjusts the starting V<sub>OUT</sub> voltage when no RF signal is present. For V<sub>OS</sub> from 0V to 120mV, V<sub>OUT</sub> is unaffected by V<sub>OS</sub>. For V<sub>OS</sub> > 120mV, V<sub>OUT</sub> is the sum of V<sub>OS</sub> plus the detected RF signal.

**V<sub>OUT</sub> (Pin 5):** Detector Output.

**V<sub>CC</sub> (Pin 6):** Power Supply Voltage, 2.7V to 6V. V<sub>CC</sub> should be bypassed appropriately with ceramic capacitors.

## BLOCK DIAGRAM

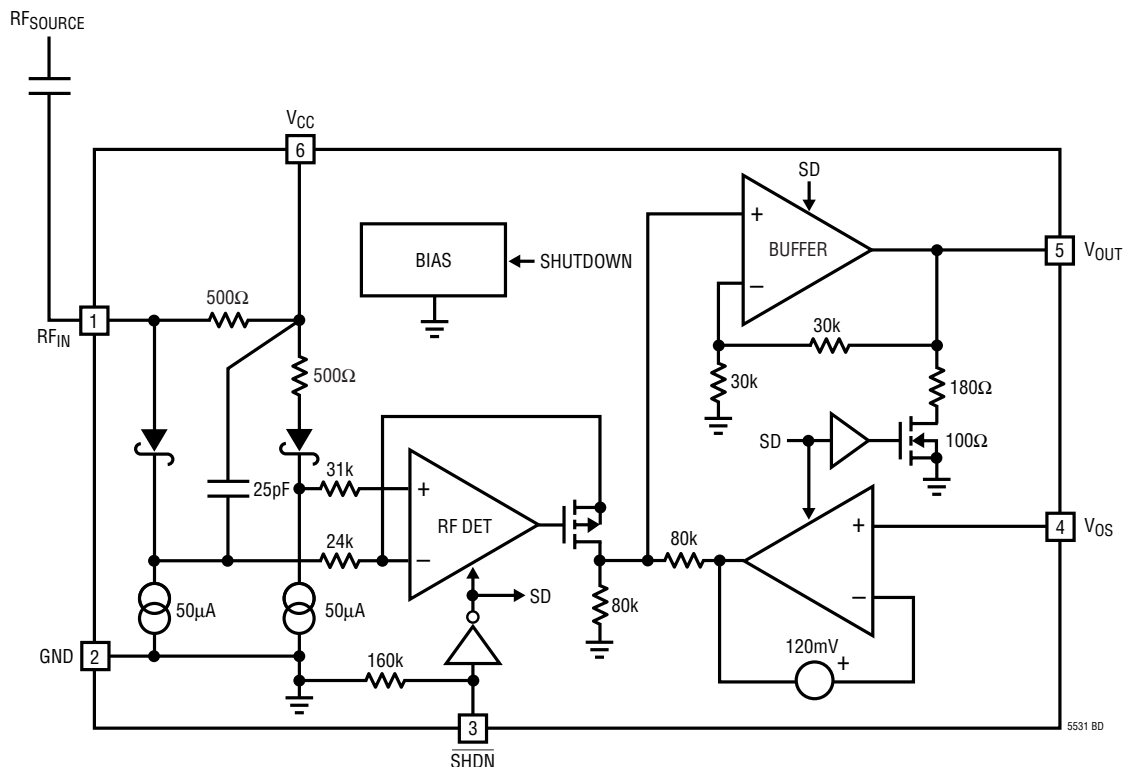



## APPLICATIONS INFORMATION

### Operation

The LTC5531 RF detector integrates several functions to provide RF power detection over frequencies ranging from 300MHz to 7GHz. These functions include an internal frequency compensated buffer amplifier, an RF Schottky diode peak detector and level shift amplifier to convert the RF input signal to DC and a delay circuit to avoid voltage transients at  $V_{OUT}$  when powering up. The LTC5531 has both shutdown and voltage offset adjustment capabilities.

### Buffer Amplifier

The output buffer amplifier is capable of supplying typically 4mA into a load. The amplifier has a bandwidth of 2MHz and a fixed internal gain of two.

The  $V_{OS}$  input controls the DC input voltage to the buffer amplifier.  $V_{OS}$  must be connected to ground if the DC output voltage is not to be changed. The buffer is initially trimmed to approximately 120mV with  $V_{OS}$  connected to ground.

The  $V_{OS}$  pin is used to change the initial  $V_{OUT}$  starting voltage. This function enables the LTC5531 output to span

the input range of a variety of analog-to-digital converters.  $V_{OUT}$  will not change until  $V_{OS}$  exceeds 120mV. The voltage at  $V_{OUT}$  for  $V_{OS} \geq 120\text{mV}$  and with no RF signal present is:

$$V_{OUT} = V_{OS}$$

$V_{OUT}$  will exactly track  $V_{OS}$  above 120mV.

### RF Detector

The internal RF Schottky diode peak detector and level shift amplifier converts the RF input signal to a low frequency signal. The detector demonstrates excellent efficiency and linearity over a wide range of input power. The Schottky diode is biased at about 55 $\mu\text{A}$  and drives a 25pF internal peak detector capacitor.

### Shutdown

The part is in shutdown mode when  $\overline{\text{SHDN}}$  is low. The supply current is reduced to  $< 2\mu\text{A}$  and  $V_{OUT}$  is shorted to ground via a 280 $\Omega$  resistor. When  $\overline{\text{SHDN}}$  is asserted high, the part is enabled after about 8 $\mu\text{s}$ .

Demo Board Schematic

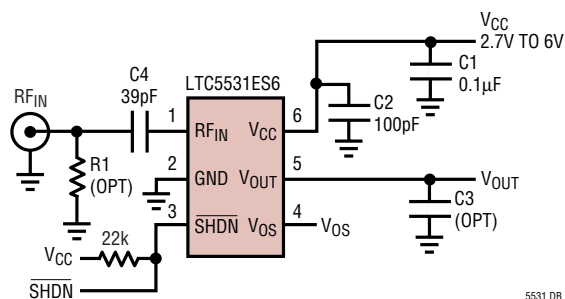

5531 DB

## APPLICATIONS INFORMATION

### Applications

The LTC5531 can be used as a self-standing signal strength measuring receiver for a wide range of input signals from  $-32\text{dBm}$  to  $10\text{dBm}$  for frequencies from  $300\text{MHz}$  to  $7\text{GHz}$ .

Operation at higher frequencies is achievable. Consult factory for more information.

The LTC5531 can be used as a demodulator for AM and ASK modulated signals with data rates up to  $2\text{MHz}$ . Depending on specific application needs, the RSSI output can be split between two branches, providing AC-coupled

data (or audio) output and DC-coupled RSSI output for signal strength measurements and AGC.

The LTC5531 can be used for RF power detection and control. Figure 1 is an example of transmitter power control, using the LTC5531 with a capacitive tap to the power amplifier. A  $0.5\text{pF}$  capacitor ( $C1$ ) followed by a  $200\Omega$  resistor ( $R1$ ) forms a coupling circuit with about  $20\text{dB}$  loss at  $900\text{MHz}$  referenced to the LTC5531 RF input pin. In the actual product implementation, component values for the capacitive tap may be different depending on parts placement, PCB parasitics and parameters of the antenna.

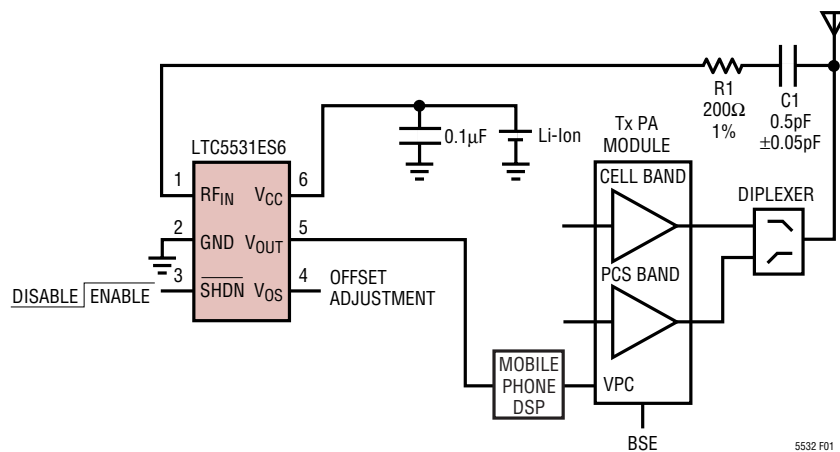
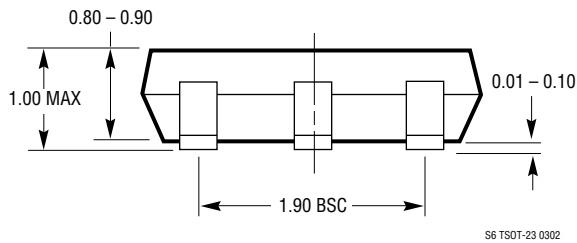
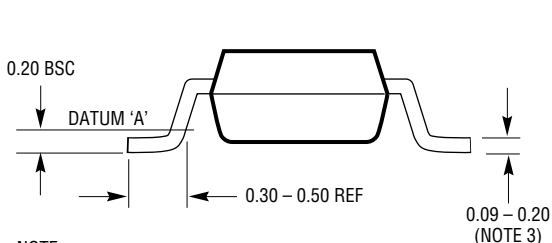
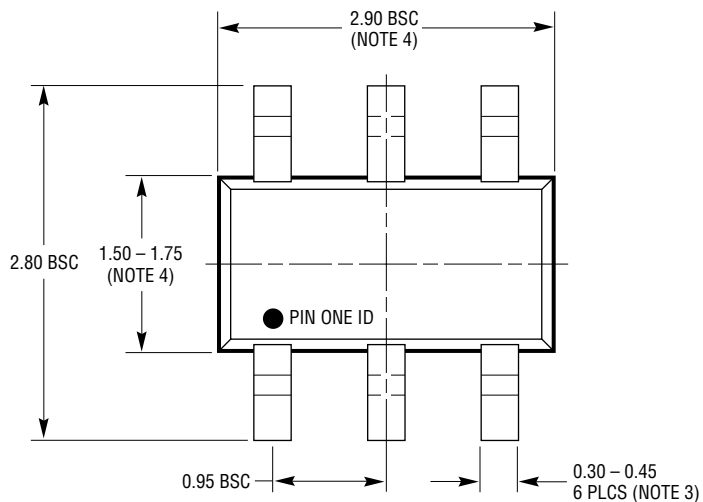
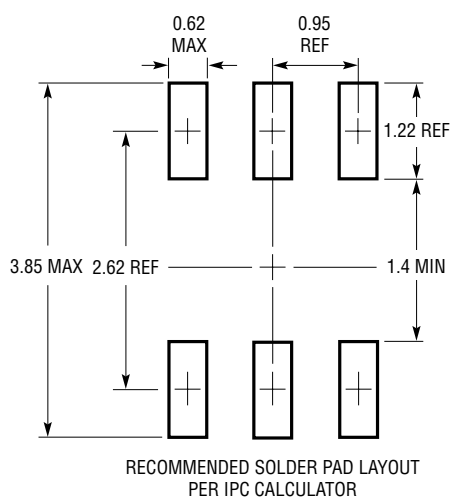

Figure 1. Mobile Phone Tx Power Control Application with a Capacitive Tap

# PACKAGE DESCRIPTION

**S6 Package**  
**6-Lead Plastic TSOT-23**  
 (Reference LTC DWG # 05-08-1636)



- NOTE:
1. DIMENSIONS ARE IN MILLIMETERS
  2. DRAWING NOT TO SCALE
  3. DIMENSIONS ARE INCLUSIVE OF PLATING
  4. DIMENSIONS ARE EXCLUSIVE OF MOLD FLASH AND METAL BURR
  5. MOLD FLASH SHALL NOT EXCEED 0.254mm
  6. JEDEC PACKAGE REFERENCE IS MO-193

S6 TSOT-23 0302

**RELATED PARTS**

PART NUMBER	DESCRIPTION	COMMENTS
<b>Infrastructure</b>		
LT5511	High Linearity Upconverting Mixer	RF Output to 3GHz, 17dBm IIP3, Integrated LO Buffer
LT5512	DC-3GHz High Signal Level Downconverting Mixer	DC to 3GHz, 21dBm IIP3, Integrated LO Buffer
LT5515	1.5GHz to 2.5GHz Direct Conversion Quadrature Demodulator	20dBm IIP3, Integrated LO Quadrature Generator
LT5516	0.8GHz to 1.5GHz Direct Conversion Quadrature Demodulator	21.5dBm IIP3, Integrated LO Quadrature Generator
LT5517	40MHz to 900MHz Direct Conversion Quadrature Demodulator	21dBm IIP3, Integrated LO Quadrature Generator
LT5519	0.7GHz to 1.4GHz High Linearity Upconverting Mixer	17.1dBm IIP3, 50Ω Single Ended RF and LO Ports
LT5520	1.3GHz to 2.3GHz High Linearity Upconverting Mixer	15.9dBm IIP3, 50Ω Single Ended RF and LO Ports
LT5522	600MHz to 2.7GHz High Linearity Downconverting Mixer	4.5V to 5.25V Supply, 25dBm IIP3 at 900MHz, NF = 12.5dB, 50Ω Single-Ended RF and LO Ports
<b>RF Power Detectors</b>		
LT5504	800MHz to 2.7GHz RF Measuring Receiver	80dB Dynamic Range, Temperature Compensated, 2.7V to 5.25V Supply
LTC®5505	300MHz to 3GHz RF Power Detectors	LTC5505-1: -28dBm to 18dBm Range, LTC5505-2: -32dBm to 12dBm Range, Temperature Compensated, 2.7V to 6V Supply
LTC5507	100kHz to 1000MHz RF Power Detector	-34dBm to 14dBm Range, Temperature Compensated, 2.7V to 6V Supply
LTC5508	300MHz to 7GHz RF Power Detector	-32dBm to 12dBm Range, Temperature Compensated, SC70 Package
LTC5509	300MHz to 3GHz RF Power Detector	36dB Dynamic Range, Temperature Compensated, SC70 Package
LTC5532	300MHz to 7GHz Precision RF Power Detector	Precision $V_{OUT}$ Offset Control, Adjustable Gain and Offset
<b>RF Building Blocks</b>		
LT5500	1.8GHz to 2.7GHz Receiver Front End	1.8V to 5.25V Supply, Dual-Gain LNA, Mixer, LO Buffer
LT5502	400MHz Quadrature IF Demodulator with RSSI	1.8V to 5.25V Supply, 70MHz to 400MHz IF, 84dB Limiting Gain, 90dB RSSI Range
LT5503	1.2GHz to 2.7GHz Direct IQ Modulator and Upconverting Mixer	1.8V to 5.25V Supply, Four-Step RF Power Control, 120MHz Modulation Bandwidth
LT5506	500MHz Quadrature IF Demodulator with VGA	1.8V to 5.25V Supply, 40MHz to 500MHz IF, -4dB to 57dB Linear Power Gain, 8.8MHz Baseband Bandwidth
LT5546	500MHz Quadrature IF Demodulator with VGA and 17MHz Baseband Bandwidth	17MHz Baseband Bandwidth, 40MHz to 500MHz IF, 1.8V to 5.25V Supply, -7dB to 56dB Linear Power Gain
<b>RF Power Controllers</b>		
LTC1757A	RF Power Controller	Multiband GSM/DCS/GPRS Mobile Phones
LTC1758	RF Power Controller	Multiband GSM/DCS/GPRS Mobile Phones
LTC1957	RF Power Controller	Multiband GSM/DCS/GPRS Mobile Phones
LTC4400	SOT-23 RF PA Controller	Multiband GSM/DCS/GPRS Phones, 45dB Dynamic Range, 450kHz Loop BW
LTC4401	SOT-23 RF PA Controller	Multiband GSM/DCS/GPRS Phones, 45dB Dynamic Range, 250kHz Loop BW
LTC4403	RF Power Controller for EDGE/TDMA	Multiband GSM/GPRS/EDGE Mobile Phones

Компания «Life Electronics» занимается поставками электронных компонентов импортного и отечественного производства от производителей и со складов крупных дистрибьюторов Европы, Америки и Азии.

С конца 2013 года компания активно расширяет линейку поставок компонентов по направлению коаксиальный кабель, кварцевые генераторы и конденсаторы (керамические, пленочные, электролитические), за счёт заключения дистрибьюторских договоров

Мы предлагаем:

- Конкурентоспособные цены и скидки постоянным клиентам.
- Специальные условия для постоянных клиентов.
- Подбор аналогов.
- Поставку компонентов в любых объемах, удовлетворяющих вашим потребностям.
- Приемлемые сроки поставки, возможна ускоренная поставка.
- Доставку товара в любую точку России и стран СНГ.
- Комплексную поставку.
- Работу по проектам и поставку образцов.
- Формирование склада под заказчика.
- Сертификаты соответствия на поставляемую продукцию (по желанию клиента).
- Тестирование поставляемой продукции.
- Поставку компонентов, требующих военную и космическую приемку.
- Входной контроль качества.
- Наличие сертификата ISO.

В составе нашей компании организован Конструкторский отдел, призванный помогать разработчикам, и инженерам.

Конструкторский отдел помогает осуществить:

- Регистрацию проекта у производителя компонентов.
- Техническую поддержку проекта.
- Защиту от снятия компонента с производства.
- Оценку стоимости проекта по компонентам.
- Изготовление тестовой платы монтаж и пусконаладочные работы.



Тел: +7 (812) 336 43 04 (многоканальный)

Email: [org@lifeelectronics.ru](mailto:org@lifeelectronics.ru)