



+72V, SOT23/TDFN, Simple Swapper Hot-Swap Controllers

MAX5902/MAX5903

General Description

The MAX5902/MAX5903 are hot-swap controllers that allow a circuit card to be safely hot plugged into a live backplane without causing a glitch on the power-supply rail. These devices operate from +9V to +72V and provide the simplest hot-swap solution by eliminating all external components except the external p-channel MOSFET.

The MAX5902/MAX5903 limit the inrush current to the load and provide a circuit-breaker function for overcurrent protection. During startup the circuit-breaker function is disabled and the MAX5902/MAX5903 limit the inrush current by gradually turning on the external MOSFET. Once the external MOSFET is fully enhanced, the circuit-breaker function is enabled and the MAX5902/MAX5903 provide overcurrent protection by monitoring the voltage drop across the external MOSFET's on-resistance.

The MAX5902/MAX5903 include an undervoltage lockout (UVLO) function, ON/OFF control input, and a power-good status output, PGOOD (MAX5902) or PGOOD (MAX5903). A built-in thermal shutdown feature is also included to protect the external MOSFET in case of overheating.

The MAX5902/MAX5903 offer latched or autoretry fault management and are available with 300mV, 400mV or 500mV circuit-breaker thresholds. Both the MAX5902 and MAX5903 are available in small SOT23 and TDFN packages, and are specified for the extended -40°C to +85°C temperature range. For specific ordering information, see the *Selector Guide* at the end of the data sheet.

Applications

- | | |
|-------------------------|--------------------|
| Network Routers | Servers |
| Network Switches | RAID |
| Base Station Line Cards | Industrial Systems |

Pin Configurations



Features

- ◆ Wide +9V to +72V Operation
- ◆ Requires No External Sense Resistor
- ◆ Drives External p-Channel MOSFET
- ◆ Limits Inrush Current
- ◆ Circuit-Breaker Function
- ◆ Less than 2mA Quiescent Current
- ◆ ON/OFF Input Permits Load Power-Supply Control and Sequencing
- ◆ Adjustable Undervoltage Lockout
- ◆ Power-Good Output with +72V Rating
- ◆ Latching or Automatic Retry Fault Management
- ◆ Thermal Shutdown Helps Protect the External MOSFET
- ◆ Available in Two Small Packages
6-Pin TDFN and SOT23

Ordering Information

PART	TEMP RANGE	PIN-PACKAGE	PKG CODE
MAX5902_ _EUT-T+*	-40°C to +85°C	6 SOT23-6	U6F+6
MAX5902_ _ETT-T+*	-40°C to +85°C	6 TDFN-6	T633+2
MAX5903_ _EUT-T+*	-40°C to +85°C	6 SOT23-6	U6F+6
MAX5903_ _ETT-T+*	-40°C to +85°C	6 TDFN-6	T633+2

*For specific part numbers see the *Selector Guide* at end of data sheet.

+Denotes lead-free package.

Typical Operating Circuits

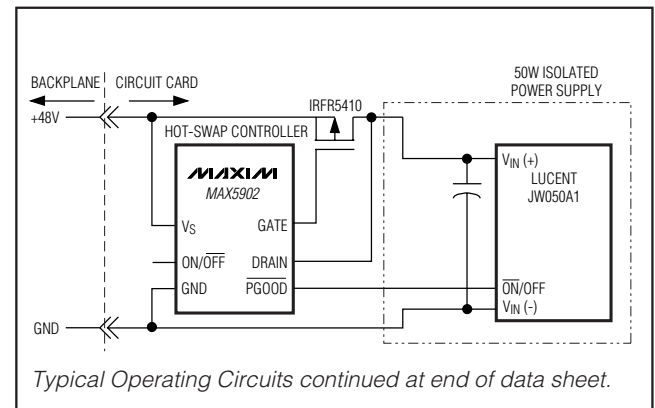

Typical Operating Circuits continued at end of data sheet.

Simple Swapper is a trademark of Maxim Integrated Products, Inc.



For pricing, delivery, and ordering information, please contact Maxim/Dallas Direct! at 1-888-629-4642, or visit Maxim's website at www.maxim-ic.com.

+72V, SOT23/TDFN, Simple Swapper Hot-Swap Controllers

ABSOLUTE MAXIMUM RATINGS

Terminal Voltage (with respect to GND unless otherwise noted)
 V_S , DRAIN, PGOOD, $\overline{\text{PGOOD}}$ -0.3V to +76V
 ON/OFF -0.3V to +4V
 GATE to V_S -12V to +0.3V
 Current into any Pin $\pm 3\text{mA}$

Continuous Power Dissipation ($T_A = +70^\circ\text{C}$)
 6-Pin SOT23 (derate 9.1mW/ $^\circ\text{C}$ above $+70^\circ\text{C}$) 727mW
 6-Pin TDFN (derate 18.2mW/ $^\circ\text{C}$ above $+70^\circ\text{C}$) 1454mW
 Junction to Case
 Thermal Resistance, θ_{JC} (TDFN) 8.5°C/W
 Maximum Junction Temperature $+150^\circ\text{C}$
 Storage Temperature Range -60°C to $+150^\circ\text{C}$

Stresses beyond those listed under "Absolute Maximum Ratings" may cause permanent damage to the device. These are stress ratings only, and functional operation of the device at these or any other conditions beyond those indicated in the operational sections of the specifications is not implied. Exposure to absolute maximum rating conditions for extended periods may affect device reliability.

ELECTRICAL CHARACTERISTICS

($V_S = +9\text{V}$ to $+72\text{V}$, GND = 0V, ON/OFF open circuit, $T_A = -40^\circ\text{C}$ to $+85^\circ\text{C}$, unless otherwise noted. Typical values are at $V_S = +48\text{V}$ and $T_A = +25^\circ\text{C}$.) (Notes 1, 2)

PARAMETER	SYMBOL	CONDITIONS		MIN	TYP	MAX	UNITS
Supply Voltage	V_S			9		72	V
Supply Current	I_{GND}	Measured out of GND, PGOOD or $\overline{\text{PGOOD}}$ open circuit, DRAIN = V_S			1	2	mA
External Gate Drive	V_{GS}	$V_S - V_{\text{GATE}}$	$V_S = +36\text{V}$ to $+72\text{V}$	9	10	11	V
			$V_S = +9\text{V}$	8	8.5		
Load Voltage Slew-Rate Magnitude	SR	$ dV_{\text{DRAIN}}/dt $ $C_L = 10\mu\text{F}$	$V_S = +36\text{V}$ to $+72\text{V}$	5	9	18	V/ms
			$V_S = +9\text{V}$	3	6	11	
Default Undervoltage Lockout	V_{UVLO}	V_S increasing		28.5	31.5	34.5	V
Undervoltage Lockout Hysteresis					3.5		V
ON/OFF Pin Input Resistance	$R_{\text{ON/OFF}}$			19	32	52	k Ω
DRAIN to GND Resistance	R_{DGND}				900		k Ω
DRAIN to V_S Resistance	R_{DS}				650		k Ω
ON/OFF Reference Threshold	$V_{\text{ON/OFF}}$	$V_{\text{ON/OFF}}$ Increasing		1.14	1.26	1.38	V
ON/OFF Hysteresis					140		mV
Start Delay (Note 3)	t_{ON}			80	150	280	ms
ON/OFF Off Delay (Note 4)	t_{OFF}	$V_S - V_{\text{GATE}} < 1\text{V}$		5	10	18	ms
Circuit-Breaker Threshold	V_{CB}	$V_S - V_{\text{DRAIN}}$	MAX590_ _AEUT	200	300	460	mV
			MAX590_ _BEUT	280	400	540	
			MAX590_ _CEUT	400	500	660	
Circuit-Breaker Delay (Note 5)	t_{CB}	$(V_S - V_{\text{DRAIN}}) > V_{\text{CB}}$ until $(V_S - V_{\text{GATE}}) < 1\text{V}$, 200mV overdrive step	$C_{\text{GATE}} = 1\text{nF}$		2	6.5	μs
			$C_{\text{GATE}} = 4.7\text{nF}$		4	11	
			$C_{\text{GATE}} = 10\text{nF}$		7	17	
Restart Delay (Note 3)	t_{RS}	After circuit breaker event, MAX590_ _A_ EUT only		80	150	280	ms
Power-Good Output Low Voltage	V_{OL}	$I_{\text{OL}} = 1\text{mA}$			0.3	0.6	V

+72V, SOT23/TDFN, Simple Swapper Hot-Swap Controllers

MAX5902/MAX5903

ELECTRICAL CHARACTERISTICS (continued)

($V_S = +9V$ to $+72V$, $GND = 0V$, ON/\overline{OFF} open circuit, $T_A = -40^\circ C$ to $+85^\circ C$, unless otherwise noted. Typical values are at $V_S = +48V$ and $T_A = +25^\circ C$.) (Notes 1, 2)

PARAMETER	SYMBOL	CONDITIONS	MIN	TYP	MAX	UNITS
Power-Good Output Open-Drain Leakage Current	I_{OH}	$V_{PGOOD} = 72V$ (MAX5902) $V_{PGOOD} = 72V$ (MAX5903)			10	μA
Thermal Shutdown Temperature	T_{SD}	Junction temperature		+125		$^\circ C$
Thermal Shutdown Hysteresis	T_{HY}			15		$^\circ C$

- Note 1:** All currents into device pins are positive, all currents out of device pins are negative, and all voltages are referenced to GND, unless otherwise noted.
- Note 2:** All specifications are 100% tested at $T_A = +25^\circ C$, unless otherwise noted. Specifications over $-40^\circ C$ to $+85^\circ C$ are guaranteed by characterization.
- Note 3:** This is the delay time from a valid on condition until V_{GS} begins rising. Valid on conditions are: the device is not in undervoltage lockout; ON/\overline{OFF} is not driven low; and the device is not in thermal shutdown.
- Note 4:** This is the delay from a valid low on ON/\overline{OFF} until V_{GS} falls. Pulses on ON/\overline{OFF} less than t_{OFF} are ignored, offering glitch immunity.
- Note 5:** Guaranteed by characterization, not production tested. C_{GATE} is a capacitor from GATE to V_S .

Typical Operating Characteristics

($V_S = +48V$, $GND = 0V$, and $T_A = +25^\circ C$, unless otherwise noted. See Figure 2 for test circuits.)

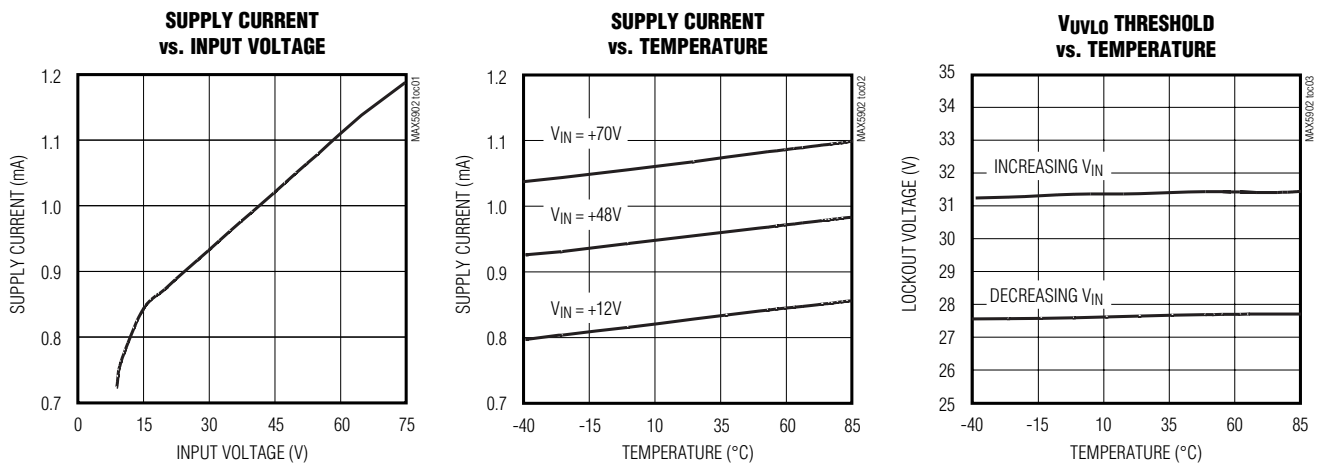

+72V, SOT23/TDFN, Simple Swapper Hot-Swap Controllers

Typical Operating Characteristics (continued)

($V_S = +48V$, $GND = 0V$, and $T_A = +25^\circ C$, unless otherwise noted. See Figure 2 for test circuits.)

GATE DRIVE VOLTAGE vs. INPUT VOLTAGE



RETRY TIMEOUT vs. TEMPERATURE

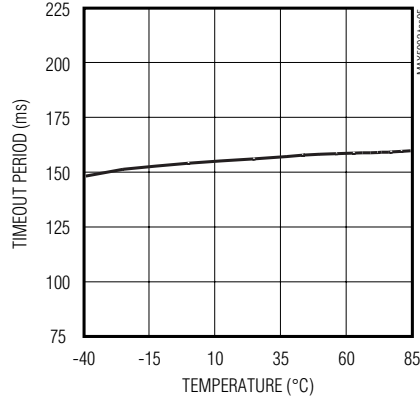

TURN-ON WAVEFORMS
 $R_L = 60\Omega$, $C_L = 100\mu F$

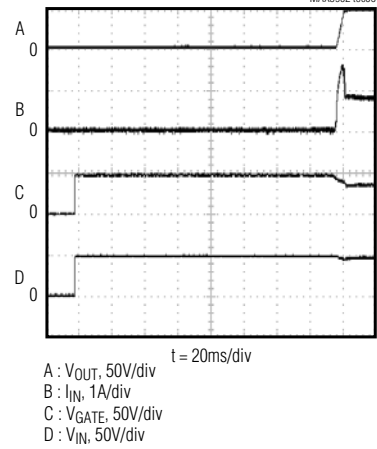

TURN-ON WAVEFORMS
 $R_L = OPEN$, $C_L = 100\mu F$



TURN-ON WAVEFORMS
 $R_L = 60\Omega$, $C_L = 10\mu F$



TURN-ON WAVEFORMS
 $R_L = 60\Omega$, $C_L = 100\mu F$

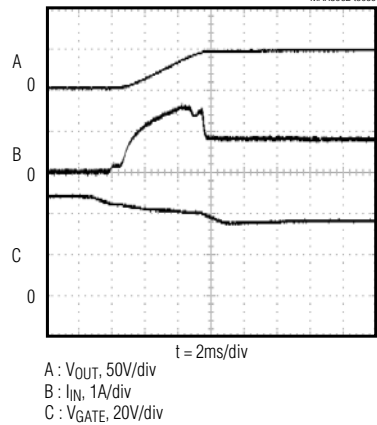

CIRCUIT-BREAKER EVENT
 $V_{OVERDRIVE} = 20mV$, $C_{GATE} = 1000pF$

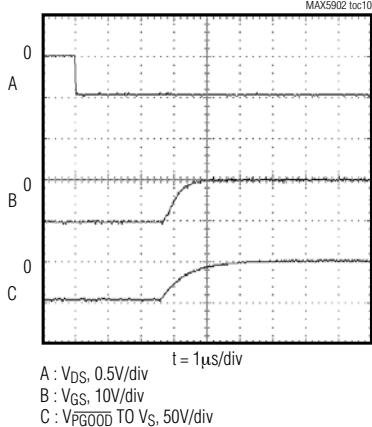

CIRCUIT-BREAKER EVENT
 $V_{OVERDRIVE} = 200mV$, $C_{GATE} = 1000pF$

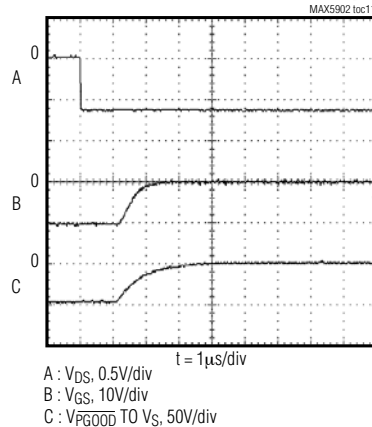

+72V, SOT23/TDFN, Simple Swapper Hot-Swap Controllers

MAX5902/MAX5903

Pin Description

PIN		NAME	FUNCTION
MAX5902	MAX5903		
1	1	V _S	Positive Supply Voltage Input and External p-Channel MOSFET Source Connection
2	2	DRAIN	Drain Sense Input for External p-Channel MOSFET. Connect DRAIN as close as possible to the MOSFET's drain and use wide circuit traces to assure good thermal coupling between the MAX5902/MAX5903 and the MOSFET. See <i>Layout Guidelines</i> Section.
3	3	GATE	Gate Drive Output for External p-Channel MOSFET
4	4	GND	Ground Connection
5	—	$\overline{\text{PGOOD}}$	Power-Good Output. $\overline{\text{PGOOD}}$ is an n-channel, open-drain, active-low output, referenced to GND.
—	5	PGOOD	Power-Good Output. PGOOD is an n-channel, open-drain, active-high output, referenced to GND.
6	6	ON/OFF	ON/OFF Control Input. ON/OFF is referenced to GND. Drive ON/OFF above 1.38V or leave unconnected to enable the device. Drive ON/OFF below 1V to disable the device. ON/OFF is also used to adjust the UVLO threshold. Internally clamped to nominally 3V through a 1k Ω resistor (See Figure 1). (See the <i>Undervoltage Lockout</i> section in the <i>Applications Information</i> .)
—	—	EP	Exposed Pad (TDFN only). Connect to GND.

Detailed Description

The MAX5902/MAX5903 are integrated hot-swap controller ICs contained in 6-pin SOT23 and TDFN packages. They allow a board to be safely hot-plugged into a live backplane without causing a glitch on the power-supply rail. They are well suited for +48V power systems allowing cost-effective, simple, and compact design. The MAX5902/MAX5903 operate from +9V to +72V to cover a wide range of end equipment hot-swap needs. They require only an external p-channel power MOSFET to provide hot-swap control. Figure 1 shows a functional block diagram of the MAX5902/MAX5903.

The MAX5902/MAX5903 controls an external p-channel power MOSFET placed in the positive power-supply pathway. When power is first applied, the MAX5902/MAX5903 keep the MOSFET turned off. The MAX5902/MAX5903 hold the MOSFET off indefinitely if ON/OFF is held low, if the supply voltage is below the undervoltage lockout level, or if the die temperature exceeds +125°C. If none of these conditions exist for 150ms (typ), the MAX5902/MAX5903 begin to gradually turn on the MOSFET. During this turn-on phase, the MAX5902/MAX5903 slowly enhance the MOSFET, allowing the voltage on the load, i.e. the drain of the MOSFET, to rise at a rate of 9V/ms (typ). The inrush current to the load is thus limited to a level proportional to the load capacitance, and the constant slew rate. After



Figure 1. Functional Block Diagram

the MOSFET is fully enhanced, and the load voltage is settled to its final value, the MAX5902A/ MAX5903A and MAX5902L/MAX5903L monitor the voltage drop across the MOSFET. If the voltage drop exceeds the circuit-breaker threshold the MAX5902A/MAX5903A and

+72V, SOT23/TDFN, Simple Swapper Hot-Swap Controllers

MAX5902L/MAX5903L turn off the MOSFET, disconnecting the load immediately. If no circuit-breaker fault exists, the MAX5902/MAX5903 assert the power-good output. Then, if any of four conditions exist, the power-good output deasserts and the MAX5902/MAX5903 turn off the MOSFET. The four conditions are: the voltage across the MOSFET exceeds the circuit-breaker threshold; the supply voltage falls below the undervoltage lockout level; the die temperature exceeds +125°C; or ON/OFF is forced low. After a circuit-breaker fault, the MAX5902L/MAX5903L keep the MOSFET off until the power is cycled, or the part is reset by toggling ON/OFF low for 10ms (typ). After a circuit-breaker fault, the MAX5902A/MAX5903A automatically restarts in 150ms (typ). All versions automatically restart after a

thermal fault, or an undervoltage shutdown, if the fault condition goes away for at least 150ms (typ).

ON/OFF offers external control of the MAX5902/MAX5903, facilitating power-supply sequencing, and may also be used to change the undervoltage lockout (UVL) level. UVLO keeps the external MOSFET switched off as long as the input voltage is below the desired level.

A power-good output, $\overline{\text{PGOOD}}$ (MAX5902) or PGOOD (MAX5903), asserts when the external MOSFET is fully enhanced and the source-drain voltage is below the circuit-breaker threshold. $\overline{\text{PGOOD}}$ and PGOOD are open-drain outputs referenced to GND, and can withstand up to +72V.



Figure 2. Test Circuits

+72V, SOT23/TDFN, Simple Swapper Hot-Swap Controllers

MAX5902/MAX5903



Figure 3. Programmed +18V Lockout, with Optional Optocoupler On/Off Control.

A thermal shutdown feature protects the external MOSFET by turning it off if the die temperature of the MAX5902/MAX5903 exceeds +125°C. The MAX5902/MAX5903 must be in good thermal contact with the external MOSFET. See *Layout Guidelines* in the *Applications* section of the data sheet.

A circuit-breaker function monitors the voltage across the external MOSFET, V_{SD} , and turns off the MOSFET if V_{SD} exceeds the circuit-breaker threshold, V_{CB} . The circuit-breaker function is enabled after the MOSFET is fully enhanced. Three threshold voltage options are available—300mV, 400mV, and 500mV. One version is available with no circuit-breaker function. Fault management for the MAX5902/MAX5903 is offered with two different configurations; latched and automatic retry.

Latched Circuit Breaker

After a circuit-breaker trip event, the latched versions (MAX5902L/MAX5903L) drive GATE to V_S , turning off the external MOSFET, and $\overline{\text{PGOOD}}$ (PGOOD) is deasserted. A latched off condition needs to be reset by toggling ON/OFF low for at least 10ms, or by cycling the power supply, V_S .

Automatic Retry Circuit Breaker

After a circuit-breaker trip event, the automatic retry versions (MAX5902A/MAX5903A) drive GATE to V_S , turning off the external MOSFET, and $\overline{\text{PGOOD}}$ (PGOOD) is deasserted. If the start conditions are met for a full 150ms (t_{RS}) the start sequence is re-initiated. The start conditions are: the device is not in UVLO; ON/OFF is not driven low; and the device is not in thermal shutdown.

No Circuit Breaker

For the versions without a circuit breaker, MAX5902N (MAX5903N), $\overline{\text{PGOOD}}$ (PGOOD) are asserted when the MOSFET is fully enhanced. Once powered up the MAX5902N/MAX5903N ignore the MOSFET drain-to-source voltage for applications where a circuit-breaker function is not desired.

Applications Information

ON/OFF Control Input

The ON/OFF control input provides three functions: external ON/OFF control; setting of the UVLO level; and resetting after a circuit-breaker event has caused the MAX5902L/MAX5903L to turn off the external MOSFET. Pulling ON/OFF to GND for at least 10ms (t_{OFF}) forces the MAX5902/MAX5903 to turn off the external MOSFET (see Figure 3 for a circuit example). To reset the MAX5902L/MAX5903L after a circuit-breaker event, toggle ON/OFF to GND for at least 10ms (t_{OFF}).

ON/OFF can be used to sequence power supplies. Connecting a capacitor from ON/OFF to GND will delay the rise of ON/OFF proportional to the capacitance and input impedance of ON/OFF, typically 33kΩ (Figure 4).

The MAX5902/MAX5903 can be controlled by logic-level signals. Logic-level signals of 3.3V or 1.8V may be directly connected to ON/OFF. For 5V logic level control, insert a series 47kΩ resistor as shown in Figure 5.



Figure 4. Power-Supply Sequencing

+72V, SOT23/TDFN, Simple Swapper Hot-Swap Controllers



Figure 5. Logic Control

Turn-On and Turn-Off Delays

After power is applied, or ON/OFF is released, there is a 150ms delay (t_{ON}) before the gate ramp is started. This delay is also the automatic restart time delay.

In the event of a circuit-breaker condition or an over-temperature fault condition, the turn-off delay is less than 4μs. An undervoltage condition must exist for at least 10ms (t_{OFF}) before the MAX5902/MAX5903 turns off the external MOSFET. ON/OFF must be held low for at least 10ms (t_{OFF}) before the MAX5902/MAX5903 turns off the external MOSFET. Turn-off delay minimizes spurious shutdowns due to noisy signals or momentary voltage spikes, as well as preventing accidental resetting of the circuit-breaker latch (MAX5902L/MAX5903L).

Thermal Shutdown

A thermal shutdown feature helps protect the external MOSFET. If the die temperature of the MAX5902/MAX5903 exceeds +125°C, the MOSFET is turned off. For accurate performance the MAX5902/MAX5903 must be in close thermal contact with the external MOSFET. See the *Layout Guidelines* section for information. Due to the low power dissipation of the MAX5902/MAX5903, its junction temperature will typically be within a few degrees of the MOSFET. All versions of the MAX5902/MAX5903 automatically restart from a temperature fault when the junction temperature drops below +110°C.

Undervoltage Lockout

The MAX5902/MAX5903 turns off the external MOSFET if the magnitude of the input voltage is below the level set by ON/OFF for longer than 10ms (t_{OFF}). If ON/OFF is left unconnected, the lockout voltage (V_{UVLO}) defaults to 31.5V. V_{UVLO} may also be set to any value within the power-supply range by using external resistors. To set the lockout voltage to a value between +9V



Figure 6. Defeating Undervoltage Lockout

and +72V use a resistor divider connected between V_S and GND, with the center node of the divider connected to ON/OFF. For example, use a 3kΩ resistor (R_1 in Figure 3) from ON/OFF to GND and calculate the other resistor, R_2 , using:

$$R_2 = R_1 \times \left(\frac{V_{UVLO}}{V_{ON/OFF}} - 1 \right)$$

where V_{UVLO} is the desired lockout voltage, and $V_{ON/OFF}$ is the ON/OFF reference threshold specified in the *Electrical Characteristics* table (typically 1.26V).

Figure 3 shows an example circuit with V_{UVLO} set for +18V. To defeat the UVLO simply connect a single 100kΩ resistor between ON/OFF and V_S , as shown in Figure 6.

The Power-Good Output

The power-good output, PGOOD (PGOOD), is open-drain and asserts when the external MOSFET is fully enhanced and V_{SD} is less than the circuit-breaker threshold (V_{CB}). For versions without the circuit-breaker function (MAX5902N/MAX5903N), PGOOD (PGOOD) asserts when the external MOSFET is fully enhanced.

\overline{PGOOD} (PGOOD) deasserts within 4μs when a circuit-breaker event occurs or if the die temperature exceeds +125°C. PGOOD (PGOOD) deasserts if $V_S < V_{UVLO}$ for longer than 10ms or ON/OFF is held low for longer than 10ms.

The MAX5902 \overline{PGOOD} is active-low and the MAX5903 PGOOD is active-high. Both are open-drain n-channel MOSFETs with their sources connected to GND, and can withstand up to +72V.

+72V, SOT23/TDFN, Simple Swapper Hot-Swap Controllers

MAX5902/MAX5903

Selecting a Circuit-Breaker Threshold

The MAX5902A/MAX5903A and the MAX5902L/MAX5903L offer a circuit-breaker function to protect the external MOSFET and the load from the potentially damaging effects of excessive current. As load current flows through the external MOSFET, a voltage, V_{SD} , is generated from source to drain due to the MOSFET's on-resistance, $R_{DS(ON)}$. The MAX5902A/MAX5903A and MAX5902L/MAX5903L monitor V_{SD} when the external MOSFET is fully enhanced. If V_{SD} exceeds the circuit-breaker threshold the external MOSFET is turned off, and \overline{PGOOD} (\overline{PGOOD}) is deasserted. To accommodate different MOSFETs and different load currents the MAX5902/MAX5903 are available with circuit-breaker threshold voltages of 300mV, 400mV, and 500mV. To determine the proper circuit-breaker threshold for an application use:

$$V_{CB} > (R_{DS(ON)}) \times (I_{OUT(MAX)})$$

where $R_{DS(ON)}$ is the on-resistance of the MOSFET and $I_{OUT(MAX)}$ is the maximum expected output current.

The MAX5902N/MAX5903N have no circuit-breaker function. For these parts choose an external MOSFET which meets the load requirements.

The circuit-breaker function is intended to protect against gross overcurrent or short-circuit conditions. During a gross overcurrent or short-circuit condition, the MAX5902/MAX5903 disconnect the load by disabling the external MOSFET. For calculating the circuit-breaker threshold use the MOSFET's R_{ON} at the worst possible operating condition, and add a 20% overcurrent margin to the maximum circuit current. For instance, if a MOSFET has an R_{ON} of 0.06Ω at $T_A = +25^\circ\text{C}$, and a normalized on-resistance factor of 1.75 at $T_A = +130^\circ\text{C}$ (from the MOSFET data sheet), the R_{ON} used for calculation is the product of these two numbers, or $(0.06\Omega) \times (1.75) = 0.105\Omega$. Then, if the maximum current is expected to be 2A, using a 20% margin, the current for calculation is $(2A) \times (1.2) = 2.4A$. The resulting minimum circuit-breaker threshold is then a product of these two results, or $(0.105\Omega) \times (2.4A) = 0.252V$. The next highest minimum available threshold is 0.280V of the MAX5902ABEUT, which is an ideal choice given these parameters. Using this method to choose a circuit-breaker threshold allows the circuit to operate under worst case conditions without causing a circuit-breaker fault, but the circuit-breaker function will still operate if a short circuit, or a gross overcurrent condition exists.



Figure 7. Circuit Board Layout Example.

Determining Inrush Current

Determining a circuit's inrush current is necessary to help choose the proper MOSFET. The MAX5902/MAX5903 regulate the inrush current by means of controlling the load voltage slew rate, but inrush current is also a function of load capacitance. Determine inrush current using:

$$I = C \frac{dV}{dt} = C \times SR$$

where C is the load capacitance, and SR is the MAX5902/MAX5903 Load Voltage Slew-Rate Magnitude from the *Electrical Characteristics* table. For example, assuming a load capacitance of $100\mu\text{F}$, and using the typical value of 9V/ms for the slew rate, the inrush current is 0.9A typical.

If the maximum possible Load Voltage Slew Rate is used, the maximum inrush current calculates to 1.8A. Choose a MOSFET with a maximum pulsed current specification that exceeds the maximum inrush current.

MAXIMUM I_{LOAD} (A)	SUGGESTED EXTERNAL MOSFET	SUGGESTED MAXIM PART
0.5	IRF9540NS	MAX5902AAEUT
1	IRF9540NS	MAX5902ABEUT
2	IRF5210S	MAX5902ABEUT
3	IRF5210S	MAX5902ACEUT

$V_{IN} = +9V \text{ to } +72V$

+72V, SOT23/TDFN, Simple Swapper Hot-Swap Controllers

Suggested External MOSFETs

Layout Guidelines

Good thermal contact between the MAX5902/MAX5903 and the external MOSFET is essential for the thermal shutdown feature to operate effectively. Place the MAX5902/MAX5903 as close as possible to the drain of the external MOSFET, and use wide circuit board traces for good heat transfer. See Figure 7 for an example of a PC board layout.

Chip Information

TRANSISTOR COUNT: 658

PROCESS TECHNOLOGY: BICMOS

+72V, SOT23/TDFN, Simple Swapper Hot-Swap Controllers

Selector Guide

SOT23

PART	CIRCUIT-BREAKER FUNCTION	CIRCUIT-BREAKER THRESHOLD (mV)	POWER-GOOD OUTPUT LOGIC	TOP MARK
MAX5902NNEUT+	None	None	Active-Low	AASM
MAX5902AAEUT+	Autoretry	300	Active-Low	AASA
MAX5902ABEUT+	Autoretry	400	Active-Low	AASB
MAX5902ACEUT+	Autoretry	500	Active-Low	AASC
MAX5902LAEUT+	Latched	300	Active-Low	AASD
MAX5902LBEUT+	Latched	400	Active-Low	AASE
MAX5902LCEUT+	Latched	500	Active-Low	AASF
MAX5903NNEUT+	None	None	Active-High	AASN
MAX5903AAEUT+	Autoretry	300	Active-High	AASG
MAX5903ABEUT+	Autoretry	400	Active-High	AASH
MAX5903ACEUT+	Autoretry	500	Active-High	AASI
MAX5903LAEUT+	Latched	300	Active-High	AASJ
MAX5903LBEUT+	Latched	400	Active-High	AASK
MAX5903LCEUT+	Latched	500	Active-High	AASL

MAX5902/MAX5903

TDFN

PART	CIRCUIT-BREAKER FUNCTION	CIRCUIT-BREAKER THRESHOLD (mV)	POWER-GOOD OUTPUT LOGIC	TOP MARK
MAX5902NNETT+	None	None	Active-Low	AKH
MAX5902AAETT+	Autoretry	300	Active-Low	AKI
MAX5902ABETT+	Autoretry	400	Active-Low	AKJ
MAX5902ACETT+	Autoretry	500	Active-Low	AKK
MAX5902LAETT+	Latched	300	Active-Low	AKL
MAX5902LBETT+	Latched	400	Active-Low	AKM
MAX5902LCETT+	Latched	500	Active-Low	AKN
MAX5903NNETT+	None	None	Active-High	AKO
MAX5903AAETT+	Autoretry	300	Active-High	AKP
MAX5903ABETT+	Autoretry	400	Active-High	AKQ
MAX5903ACETT+	Autoretry	500	Active-High	AKR
MAX5903LAETT+	Latched	300	Active-High	AKS
MAX5903LBETT+	Latched	400	Active-High	AKT
MAX5903LCETT+	Latched	500	Active-High	AKU

+Denotes lead-free package.

+72V, SOT23/TDFN, Simple Swapper Hot-Swap Controllers

Typical Operating Circuits (continued)



Pin Configurations (continued)



+72V, SOT23/TDFN, Simple Swapper Hot-Swap Controllers

Package Information

(The package drawing(s) in this data sheet may not reflect the most current specifications. For the latest package outline information go to www.maxim-ic.com/packages.)

MAX5902/MAX5903



+72V, SOT23/TDFN, Simple Swapper Hot-Swap Controllers

Package Information (continued)

(The package drawing(s) in this data sheet may not reflect the most current specifications. For the latest package outline information go to www.maxim-ic.com/packages.)



COMMON DIMENSIONS			PACKAGE VARIATIONS							
SYMBOL	MIN.	MAX.	PKG. CODE	N	D2	E2	e	JEDEC SPEC	b	[(N/2)-1] x e
A	0.70	0.80	T633-1	6	1.50±0.10	2.30±0.10	0.95 BSC	MO229 / WEEA	0.40±0.05	1.90 REF
D	2.90	3.10	T633-2	6	1.50±0.10	2.30±0.10	0.95 BSC	MO229 / WEEA	0.40±0.05	1.90 REF
E	2.90	3.10	T833-1	8	1.50±0.10	2.30±0.10	0.65 BSC	MO229 / WEEC	0.30±0.05	1.95 REF
A1	0.00	0.05	T833-2	8	1.50±0.10	2.30±0.10	0.65 BSC	MO229 / WEEC	0.30±0.05	1.95 REF
L	0.20	0.40	T833-3	8	1.50±0.10	2.30±0.10	0.65 BSC	MO229 / WEEC	0.30±0.05	1.95 REF
k	0.25 MIN.		T1033-1	10	1.50±0.10	2.30±0.10	0.50 BSC	MO229 / WEED-3	0.25±0.05	2.00 REF
A2	0.20 REF.		T1033-2	10	1.50±0.10	2.30±0.10	0.50 BSC	MO229 / WEED-3	0.25±0.05	2.00 REF
			T1433-1	14	1.70±0.10	2.30±0.10	0.40 BSC	----	0.20±0.05	2.40 REF
			T1433-2	14	1.70±0.10	2.30±0.10	0.40 BSC	----	0.20±0.05	2.40 REF

NOTES:

- ALL DIMENSIONS ARE IN mm. ANGLES IN DEGREES.
- COPLANARITY SHALL NOT EXCEED 0.08 mm.
- WARPAGE SHALL NOT EXCEED 0.10 mm.
- PACKAGE LENGTH/PACKAGE WIDTH ARE CONSIDERED AS SPECIAL CHARACTERISTIC(S).
- DRAWING CONFORMS TO JEDEC MO229, EXCEPT DIMENSIONS "D2" AND "E2", AND T1433-1 & T1433-2.
- "N" IS THE TOTAL NUMBER OF LEADS.
- NUMBER OF LEADS SHOWN ARE FOR REFERENCE ONLY.
- MARKING IS FOR PACKAGE ORIENTATION REFERENCE ONLY.

DALLAS SEMICONDUCTOR

MAXIM

TITLE: PACKAGE OUTLINE, 6,8,10 & 14L TDFN, EXPOSED PAD, 3x3x0.80 mm

APPROVAL: _____ DOCUMENT CONTROL NO. 21-0137 REV. H 2/2

-DRAWING NOT TO SCALE-

Maxim cannot assume responsibility for use of any circuitry other than circuitry entirely embodied in a Maxim product. No circuit patent licenses are implied. Maxim reserves the right to change the circuitry and specifications without notice at any time.

14 Maxim Integrated Products, 120 San Gabriel Drive, Sunnyvale, CA 94086 408-737-7600

Компания «Life Electronics» занимается поставками электронных компонентов импортного и отечественного производства от производителей и со складов крупных дистрибьюторов Европы, Америки и Азии.

С конца 2013 года компания активно расширяет линейку поставок компонентов по направлению коаксиальный кабель, кварцевые генераторы и конденсаторы (керамические, пленочные, электролитические), за счёт заключения дистрибьюторских договоров

Мы предлагаем:

- Конкурентоспособные цены и скидки постоянным клиентам.
- Специальные условия для постоянных клиентов.
- Подбор аналогов.
- Поставку компонентов в любых объемах, удовлетворяющих вашим потребностям.
- Приемлемые сроки поставки, возможна ускоренная поставка.
- Доставку товара в любую точку России и стран СНГ.
- Комплексную поставку.
- Работу по проектам и поставку образцов.
- Формирование склада под заказчика.
- Сертификаты соответствия на поставляемую продукцию (по желанию клиента).
- Тестирование поставляемой продукции.
- Поставку компонентов, требующих военную и космическую приемку.
- Входной контроль качества.
- Наличие сертификата ISO.

В составе нашей компании организован Конструкторский отдел, призванный помогать разработчикам, и инженерам.

Конструкторский отдел помогает осуществить:

- Регистрацию проекта у производителя компонентов.
- Техническую поддержку проекта.
- Защиту от снятия компонента с производства.
- Оценку стоимости проекта по компонентам.
- Изготовление тестовой платы монтаж и пусконаладочные работы.



Тел: +7 (812) 336 43 04 (многоканальный)

Email: org@lifeelectronics.ru

www.lifeelectronics.ru