

AC Filter Cost Optimized



See below:

**Approvals and Compliances**

**Description**

- Line filter in standard and medical version
- 1-stage
- standard attenuation

**Characteristics**

- Designed for universal industrial applications
- High attenuation at maximum resp. asymmetric load independent from the line impedance
- Protection against interference voltage from the mains
- Possible interferences generated in the equipment are strongly attenuated
- Especially designed for industrial applications such as: Frequency Converters, Stepper Motor Drives, UPS-Systems, Inverters
- Suitable for use in equipment according to IEC/UL 62368-1
- Suitable for use in medical equipment according to IEC/UL 60601-1

**Other versions on request**

- Version with wire connection

**References**

Alternative: Standard version

We recommend for new applications the type [FMAB NEO](#)

**Weblinks**

[pdf data sheet](#), [html datasheet](#), [General Product Information](#), [Approvals](#), [Distributor-Stock-Check](#), [Detailed request for product](#), [Microsite](#)

**Technical Data**

|                                 |   |
|---------------------------------|---|
| Ratings IEC                     | 6 - 20A @ Ta 40 °C / 250VAC; 50Hz                                       |
| Ratings UL/CSA                  | 6 - 20A @ Ta 40 °C / 125VAC; 60Hz                                       |
| Leakage Current                 | standard < 0.35mA (250V / 60Hz)   |
| Dielectric Strength             | 1.7 kVDC between L-N<br>2.7 kVDC between L/N-PE<br>Test voltage (2 sec) |
| Allowable Operation Temperature | -25 °C to 100 °C  |
| Climatic Category               | 25/100/21 acc. to IEC 60068-1   |
| Protection Class                | Suitable for appliances with protection class I acc. to IEC 61140       |
| Terminal                        | Quick connect terminals 6.3 x 0.8 mm                                    |
| Material: Housing               | Nickel plated steel   |

|             |  |
|-------------|--|
| Line Filter | Standard and Medical Version, IEC 60939, UL 1283, CSA C22.2 no. 8<br><a href="#">Technical Details</a> |
| MTBF        | > 200'000h acc. to MIL-HB-217 F  |

**Approvals and Compliances**



Detailed information on product approvals, code requirements, usage instructions and detailed test conditions can be looked up in [Details about Approvals](#)

SCHURTER products are designed for use in industrial environments. They have approvals from independent testing bodies according to national and international standards. Products with specific characteristics and requirements such as required in the automotive sector according to IATF 16949, medical technology according to ISO 13485 or in the aerospace industry can be offered exclusively with customer-specific, individual agreements by SCHURTER.

## Approvals







The approval mark is used by the testing authorities to certify compliance with the safety requirements placed on electronic products.

Approval Reference Type: FMLB

| Approval Logo  | Certificates  | Certification Body | Description                  |
|--|---------------|--------------------|------------------------------|
|  | VDE Approvals | VDE                | Certificate Number: 40004673 |
|  | UL Approvals  | UL                 | UL File Number: E72928       |



## Product standards

Product standards that are referenced

| Organization   | Design                | Standard         | Description   |
|--|-----------------------|------------------|---|
|  | Designed according to | IEC 60320-1      | Appliance couplers for household and similar general purposes         |
|  | Designed according to | IEC 60939        | Passive filters for suppressing electromagnetic interference          |
|  | Designed according to | UL 498           | Standard for Attachment Plugs and Receptacles                         |
|  | Designed according to | UL 1283          | Electromagnetic interference filters                                  |
|  | Designed according to | CSA C22.2 no. 42 | General Use Receptacles, Attachment Plugs, and Similar Wiring Devices |
|  | Designed according to | CSA C22.2 no. 8  | Electromagnetic interference (EMI) filters                            |





## Application standards

Application standards where the product can be used

| Organization   | Design                         | Standard       | Description  |
|--|--------------------------------|----------------|--|
|  | Designed for applications acc. | IEC/UL 62368-1 | IEC 62368-1 includes the basic requirements for safety of audio, video, information technology and office equipment. |
|  | Designed for applications acc. | IEC 60601-1    | Medical electrical equipment - Part 1: General requirements for basic safety and essential performance               |

## Compliances

The product complies with following Guide Lines

| Identification   | Details                      | Initiator   | Description   |
|--|------------------------------|-------------|---|
|  | CE declaration of conformity | SCHURTER AG | The CE marking declares that the product complies with the applicable requirements laid down in the harmonisation of Community legislation on its affixing in accordance with EU Regulation 765/2008. |
|  | RoHS                         | SCHURTER AG | Directive RoHS 2011/65/EU, Amendment (EU) 2015/863  |
|  | China RoHS                   | SCHURTER AG | The law SJ / T 11363-2006 (China RoHS) has been in force since 1 March 2007. It is similar to the EU directive RoHS.  |
|  | REACH                        | SCHURTER AG | On 1 June 2007, Regulation (EC) No 1907/2006 on the Registration, Evaluation, Authorization and Restriction of Chemicals 1 (abbreviated as "REACH") entered into force.                               |
|  | Medical Technology           | SCHURTER AG | Suitable for use in medical equipment according to IEC/UL 60601-1   |

Dimension [mm]

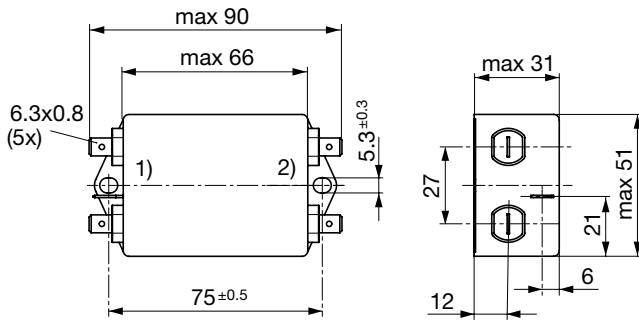

Diagrams

Standard version

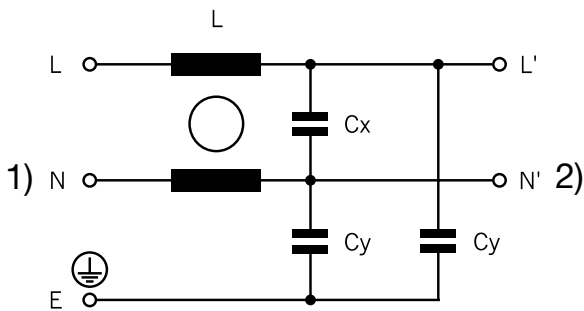

1) Line  
2) Load

Medical Version (M5)

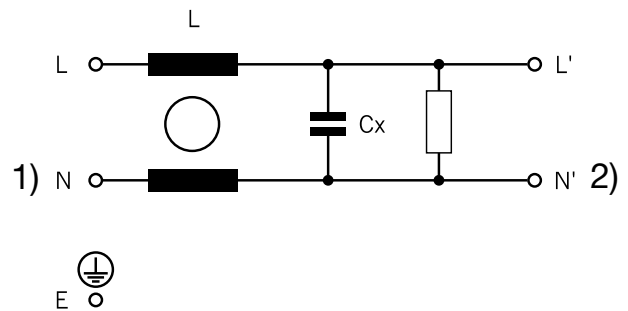

1) Line  
2) Load

Medical Version (M80)

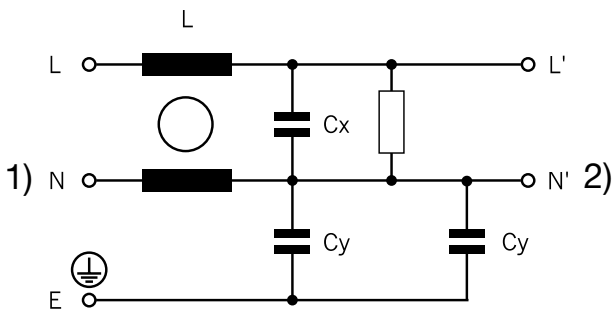

1) Line  
2) Load

Attenuation Loss

--- 50Ω differential mode    \_\_\_\_ 50Ω common mode

Standard version

6 A

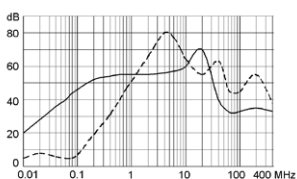

10 A

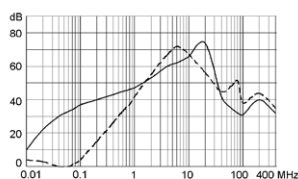

16 A

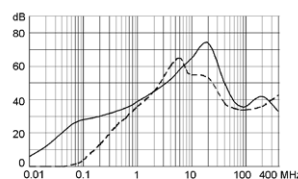

20 A

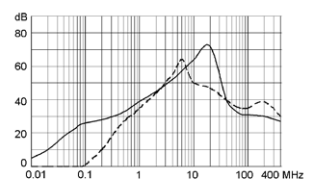

## Medical version (M5)



## Medical version (M80)



## All Variants

| Rated Current [A] | Filter-Type           | L [mH]  | Cx (X2) [µF] | Cy (Y2) [nF] | Weight [g] | Housings | Order Number |
|-------------------|-----------------------|---------|--------------|--------------|------------|----------|--------------|
| 6                 | Standard version      | 2 x 14  | 0.1          | 3.3          | 212 g      | 49       | 5500.2035    |
| 10                | Standard version      | 2 x 5   | 0.1          | 3.3          | 212 g      | 49       | 5500.2036    |
| 16                | Standard version      | 2 x 2   | 0.1          | 3.3          | 208 g      | 49       | 5500.2037    |
| 20                | Standard version      | 2 x 1.5 | 0.1          | 3.3          | 218 g      | 49       | 5500.2038    |
| 6                 | Medical Version (M5)  | 2 x 14  | 0.1          | -            | 212 g      | 49       | 5500.2082    |
| 10                | Medical Version (M5)  | 2 x 5   | 0.1          | -            | 212 g      | 49       | 5500.2083    |
| 16                | Medical Version (M5)  | 2 x 2   | 0.1          | -            | 208 g      | 49       | 5500.2084    |
| 20                | Medical Version (M5)  | 2 x 1.5 | 0.1          | -            | 218 g      | 49       | 5500.2085    |
| 6                 | Medical Version (M80) | 2 x 14  | 0.1          | 0.47         | 212 g      | 49       | 5500.2094    |
| 10                | Medical Version (M80) | 2 x 5   | 0.1          | 0.47         | 212 g      | 49       | 5500.2095    |
| 16                | Medical Version (M80) | 2 x 2   | 0.1          | 0.47         | 208 g      | 49       | 5500.2096    |
| 20                | Medical Version (M80) | 2 x 1.5 | 0.1          | 0.47         | 218 g      | 49       | 5500.2097    |

Most Popular.

Availability for all products can be searched real-time: <https://www.schurter.com/en/Stock-Check/Stock-Check-SCHURTER>

**Packaging unit** 10 Pcs

Компания «Life Electronics» занимается поставками электронных компонентов импортного и отечественного производства от производителей и со складов крупных дистрибьюторов Европы, Америки и Азии.

С конца 2013 года компания активно расширяет линейку поставок компонентов по направлению коаксиальный кабель, кварцевые генераторы и конденсаторы (керамические, пленочные, электролитические), за счёт заключения дистрибьюторских договоров

Мы предлагаем:

- Конкурентоспособные цены и скидки постоянным клиентам.
- Специальные условия для постоянных клиентов.
- Подбор аналогов.
- Поставку компонентов в любых объемах, удовлетворяющих вашим потребностям.
- Приемлемые сроки поставки, возможна ускоренная поставка.
- Доставку товара в любую точку России и стран СНГ.
- Комплексную поставку.
- Работу по проектам и поставку образцов.
- Формирование склада под заказчика.
- Сертификаты соответствия на поставляемую продукцию (по желанию клиента).
- Тестирование поставляемой продукции.
- Поставку компонентов, требующих военную и космическую приемку.
- Входной контроль качества.
- Наличие сертификата ISO.

В составе нашей компании организован Конструкторский отдел, призванный помогать разработчикам, и инженерам.

Конструкторский отдел помогает осуществить:

- Регистрацию проекта у производителя компонентов.
- Техническую поддержку проекта.
- Защиту от снятия компонента с производства.
- Оценку стоимости проекта по компонентам.
- Изготовление тестовой платы монтаж и пусконаладочные работы.



Тел: +7 (812) 336 43 04 (многоканальный)  
Email: [org@lifeelectronics.ru](mailto:org@lifeelectronics.ru)