



Main

Range of product	OsiSense XU
Series name	Application packaging
Electronic sensor type	Photo-electric sensor
Sensor name	XUK
Sensor design	Compact 50 x 50
Detection system	Reflex
Material	Plastic
Type of output signal	Discrete
Supply circuit type	DC
Wiring technique	3-wire
Discrete output type	PNP or NPN
Discrete output function	1 NO or 1 NC programmable
Electrical connection	1 male connector M12 adjustable 2 positions, 4 pins
Product specific application	Detection of transparent object
Emission	Red reflex
[Sn] nominal sensing distance	4.92 ft (1.5 m) reflex need reflector XUZC50

Complementary

Enclosure material	PC
Lens material	PMMA
Output type	Solid state
Output function governance	Dark
Add on output	Without
Cable composition	2 x 0.34 mm ²
Wire insulation material	PVC
Cable outer diameter	0.24 in (6 mm)
Status LED	1 LED output state
[Us] rated supply voltage	12...24 V DC with reverse polarity protection
Supply voltage limits	10...30 V AC/DC
Switching capacity in mA	<= 100 mA (overload and short-circuit protection)
Switching frequency	<= 1.5 kHz
Voltage drop	<= 2 V (closed state)
Current consumption	<= 35 mA (no-load)
Time delay range	0.1...5 s monostable, on-delay or off-delay (programmable) delay
Delay first up	<= 80 ms
Delay response	<= 0.3 ms
Delay recovery	<= 0.3 ms
Setting-up	Sensitivity adjustment by potentiometer
Depth	1.97 in (50 mm)
Height	1.97 in (50 mm)
Width	0.71 in (18 mm)
Product weight	0.08 lb(US) (0.035 kg)
Kit composition	Sensor Bracket XULZ41

Environment

product certifications	CE
------------------------	----

The information provided in this documentation contains general descriptions and/or technical characteristics of the products contained herein. This documentation is not intended as a substitute for and is not to be used for determining suitability or reliability of these products for specific user applications. It is the duty of any such user or integrator to perform the appropriate and complete risk analysis, evaluation and testing of the products with respect to the relevant specific application or use thereof. Neither Schneider Electric Industries SAS nor any of its affiliates or subsidiaries shall be responsible or liable for misuse of the information contained herein.

CSA
UL

ambient air temperature for operation	-13...131 °F (-25...55 °C)
ambient air temperature for storage	-40...158 °F (-40...70 °C)
vibration resistance	7 gn, amplitude = +/- 2 mm (f = 10...55 Hz) conforming to IEC 60068-2-6
shock resistance	20 gn (duration = 11 ms) conforming to IEC 60068-2-27
IP degree of protection	IP651 conforming to NF C 20-010 IP65 conforming to IEC 60529

Offer Sustainability

Not Green Premium product	Not Green Premium product
Compliant - since 0841 - Schneider Electric declaration of conformity	Compliant - since 0841 - Schneider Electric declaration of conformity
Reference not containing SVHC above the threshold	Reference not containing SVHC above the threshold
WARNING: This product can expose you to chemicals including:	WARNING: This product can expose you to chemicals including:
Diisononyl phthalate (DINP), which is known to the State of California to cause cancer, and	Diisononyl phthalate (DINP), which is known to the State of California to cause cancer, and
Di-isodecyl phthalate (DIDP), which is known to the State of California to cause birth defects or other reproductive harm.	Di-isodecyl phthalate (DIDP), which is known to the State of California to cause birth defects or other reproductive harm.
For more information go to www.p65warnings.ca.gov	For more information go to www.p65warnings.ca.gov

Contractual warranty

Warranty period	18 months
-----------------	-----------

Dimensions

- With cover open
- Fixing bracket mounting according to position of connector

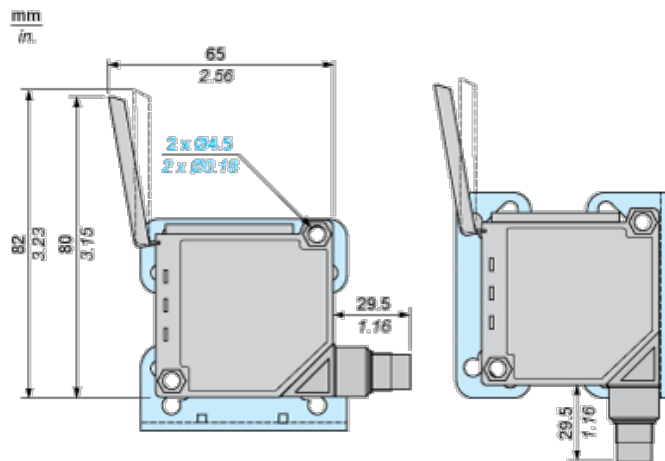

Bracket Fixing

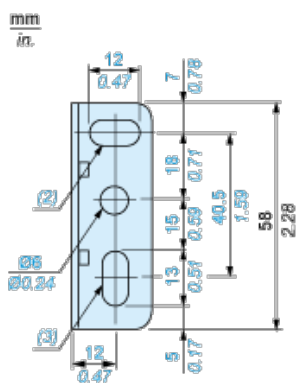

- (2) 1 elongated hole Ø 6 x 12
- (3) 1 elongated hole Ø 6 x 13

Wiring Schemes

Connector Scheme

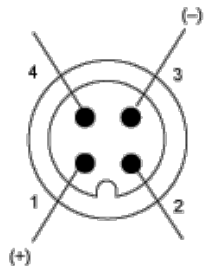

- 1 : (+)
- 2 : Alarm output
- 3 : (-)
- 4 : Output signal

NC Programmed

PNP programmed output

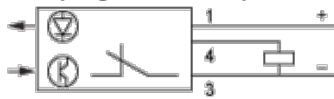

NPN programmed output

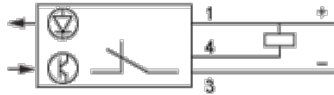

NO Programmed

PNP programmed output

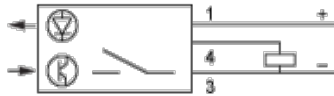

NPN programmed output

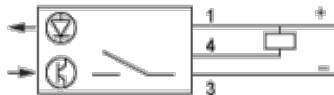

Alarm Output

NPN programmed



PNP programmed



Компания «Life Electronics» занимается поставками электронных компонентов импортного и отечественного производства от производителей и со складов крупных дистрибьюторов Европы, Америки и Азии.

С конца 2013 года компания активно расширяет линейку поставок компонентов по направлению коаксиальный кабель, кварцевые генераторы и конденсаторы (керамические, пленочные, электролитические), за счёт заключения дистрибьюторских договоров

Мы предлагаем:

- Конкурентоспособные цены и скидки постоянным клиентам.
- Специальные условия для постоянных клиентов.
- Подбор аналогов.
- Поставку компонентов в любых объемах, удовлетворяющих вашим потребностям.
- Приемлемые сроки поставки, возможна ускоренная поставка.
- Доставку товара в любую точку России и стран СНГ.
- Комплексную поставку.
- Работу по проектам и поставку образцов.
- Формирование склада под заказчика.
- Сертификаты соответствия на поставляемую продукцию (по желанию клиента).
- Тестирование поставляемой продукции.
- Поставку компонентов, требующих военную и космическую приемку.
- Входной контроль качества.
- Наличие сертификата ISO.

В составе нашей компании организован Конструкторский отдел, призванный помогать разработчикам, и инженерам.

Конструкторский отдел помогает осуществить:

- Регистрацию проекта у производителя компонентов.
- Техническую поддержку проекта.
- Защиту от снятия компонента с производства.
- Оценку стоимости проекта по компонентам.
- Изготовление тестовой платы монтаж и пусконаладочные работы.



Тел: +7 (812) 336 43 04 (многоканальный)

Email: org@lifeelectronics.ru