

Analog Devices Welcomes Hittite Microwave Corporation

NO CONTENT ON THE ATTACHED DOCUMENT HAS CHANGED



THIS PAGE INTENTIONALLY LEFT BLANK

WIDEBAND FIXED ATTENUATOR FAMILY, DC - 25 GHz HMC656LP2E / HMC657LP2E / HMC658LP2E

Typical Applications

The HMC656LP2E - HMC658LP2E are ideal for:

- Fiber Optics
- Microwave Radio
- Military & Space
- Test & Measurement
- Scientific Instruments
- RF / Microwave Circuit Prototyping

Features

- 3 Attenuator Products:
10, 15, & 20 dB Fixed Attenuation Levels
- Wide Bandwidth: DC - 25 GHz
- Excellent Attenuation Accuracy
- Power Handling: +25 dBm
- 6 Lead 2x2mm SMT Package: 4mm²

Functional Diagrams

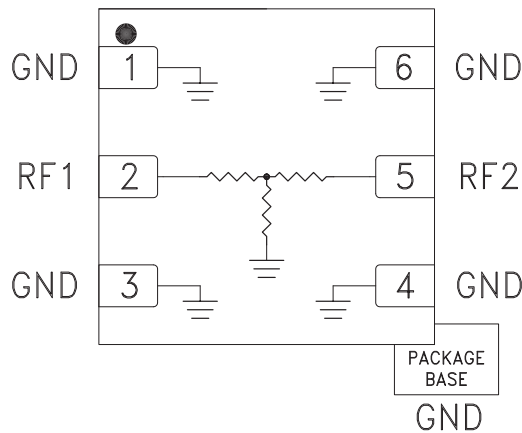

General Description

The HMC656LP2E / 657LP2E / 658LP2E are a line of wideband fixed value SMT 50 Ohm matched attenuators which offer relative attenuation levels of 10, 15 and 20 dB respectively. These passive attenuators are ideal for military, test equipment, and other wideband applications where extremely flat attenuation, and excellent VSWR vs. frequency are required.

These wideband attenuators handle up to +25 dBm of input power, and are compatible with high volume surface mount manufacturing techniques.

Electrical Specifications, $T_A = +25^\circ\text{C}$, 50 Ohm system

| Part Number | Attenuator Value | Return Loss (Min.) | Return Loss (Typ.) | Attenuation Tolerance [1] | Temperature Coefficient (Typical) [2] | Units |
|-------------|------------------|--------------------|--------------------|---------------------------|---------------------------------------|-------|
| | | | | | | GHz |
| DC - 25 | | | | | | |
| HMC656LP2E | 10 | 7 | 12 | ± 1.5 | 0.0004 | dB |
| HMC657LP2E | 15 | 7 | 14 | ± 2.0 | 0.0006 | dB |
| HMC658LP2E | 20 | 7 | 12 | ± 2.0 | 0.0004 | dB |

[1] Attenuation Tolerance is valid over temperature.

[2] Temperature Coefficient Units are dB/°C.

WIDEBAND FIXED ATTENUATOR FAMILY, DC - 25 GHz HMC656LP2E / HMC657LP2E / HMC658LP2E

Attenuation vs. Temperature

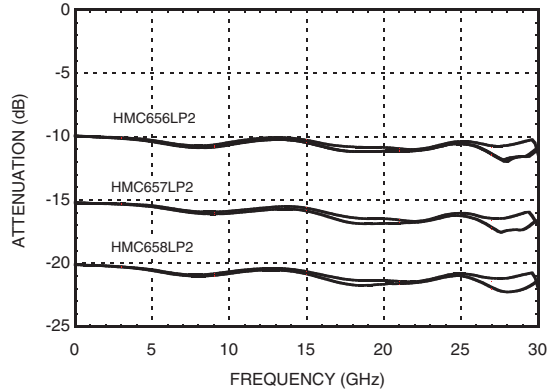

Return Loss

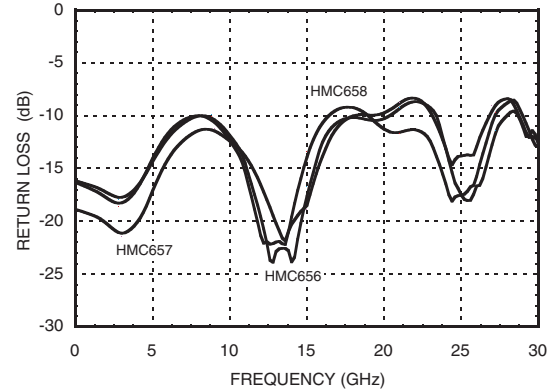

Absolute Maximum Ratings

| Part Number | HMC656LP2E | HMC657LP2E | HMC658LP2E | Units |
|-----------------------|-------------|------------|------------|-------|
| RF Input Power (CW) | 25 | 25 | 25 | dBm |
| DC Voltage Terminated | 4.9 | 4.4 | 4.8 | V |
| DC Voltage Open | 5.3 | 4.6 | 4.9 | V |
| Storage Temperature | -65 to +150 | | | °C |
| Operating Temperature | -40 to +85 | | | °C |
| ESD Sensitivity (HBM) | Class 1B | Class 1B | Class 1B | |



**ELECTROSTATIC SENSITIVE DEVICE
OBSERVE HANDLING PRECAUTIONS**

WIDEBAND FIXED ATTENUATOR FAMILY, DC - 25 GHz HMC656LP2E / HMC657LP2E / HMC658LP2E

Outline Drawing

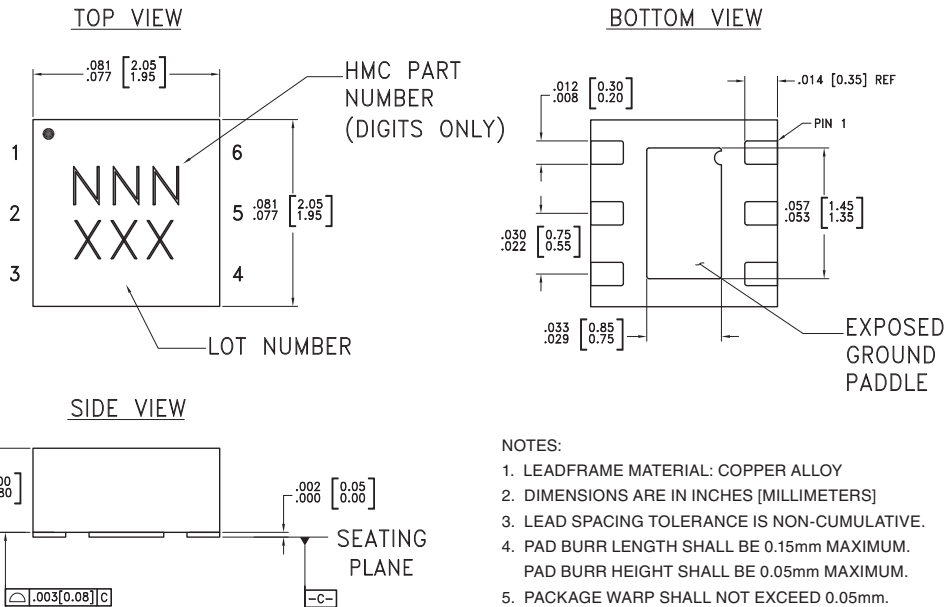

NOTES:

1. LEADFRAME MATERIAL: COPPER ALLOY
2. DIMENSIONS ARE IN INCHES [MILLIMETERS]
3. LEAD SPACING TOLERANCE IS NON-CUMULATIVE.
4. PAD BURR LENGTH SHALL BE 0.15mm MAXIMUM.
PAD BURR HEIGHT SHALL BE 0.05mm MAXIMUM.
5. PACKAGE WARP SHALL NOT EXCEED 0.05mm.
6. ALL GROUND LEADS AND GROUND PADDLE MUST BE SOLDERED TO PCB RF GROUND.
7. REFER TO HITTITE APPLICATION NOTE FOR SUGGESTED LAND PATTERN.

Package Information



| Part Number | Package Body Material | Lead Finish | MSL Rating | Package Marking ^[3] |
|-------------------------------|--|---------------|---------------------|--------------------------------|
| HMC656LP2 through HMC658LP2 | Low Stress Injection Molded Plastic | Sn/Pb Solder | MSL1 ^[1] | NNN XXX |
| HMC656LP2E through HMC658LP2E | RoHS-compliant Low Stress Injection Molded Plastic | 100% matte Sn | MSL1 ^[2] | NNN XXX |

[1] Max peak reflow temperature of 235 °C

[2] Max peak reflow temperature of 260 °C

[3] 3-Digit lot number XXX

Pin Descriptions

| Pin Number | Function | Description | Interface Schematic |
|------------|----------|--|---|
| 1, 3, 4, 6 | GND | Package bottom must be connected to RF/DC ground. |  |
| 2, 5 | RF1, RF2 | This pin is DC coupled and matched to 50 Ohms. Use DC Blocking capacitors if the input / output signals have non-zero DC potential |  |

Evaluation PCB

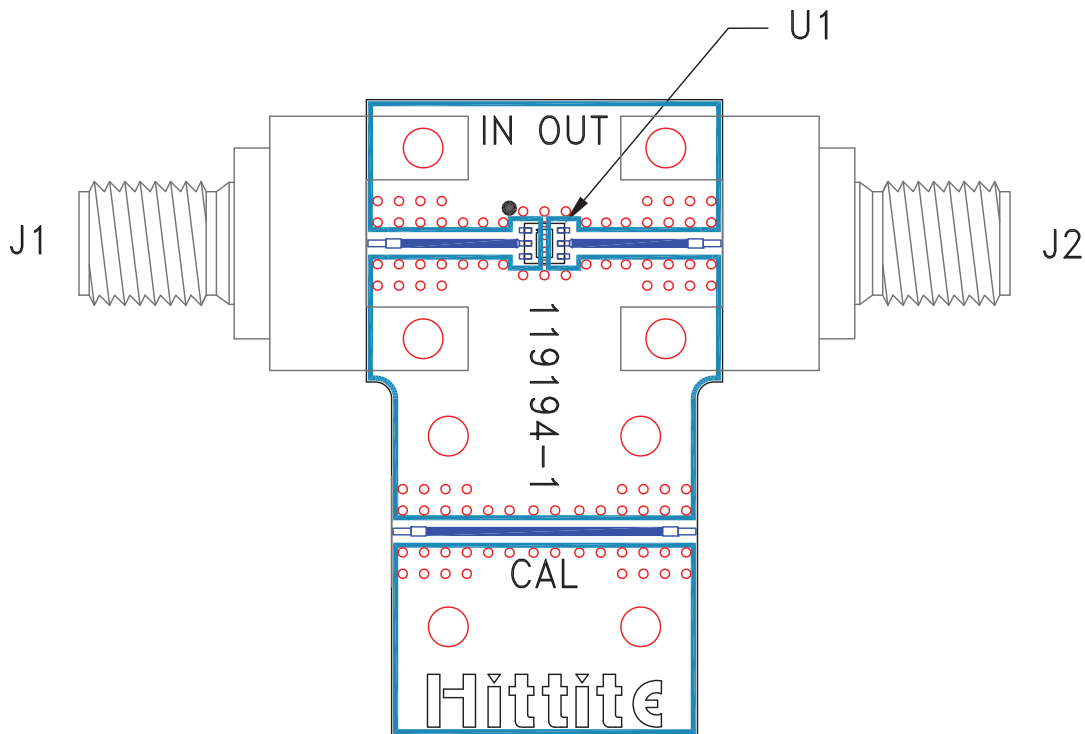

List of Materials for Evaluation PCB 119197 [1]

| Item | Description |
|---------|--|
| J1 - J2 | PCB Mount SMA Connector |
| U1 | HMC656LP2E through HMC658LP2E Passive Attenuator |
| PCB [2] | 119194 Evaluation PCB |

[1] Reference this number when ordering complete evaluation PCB

[2] Circuit Board Material: Rogers 4350

The circuit board used in the final application should be generated with proper RF circuit design techniques. Signal lines at the RF port should have 50 ohm impedance and the package ground leads and exposed paddle should be connected directly to the ground plane similar to that shown above. The evaluation circuit board shown above is available from Hittite Microwave Corporation upon request.

Компания «Life Electronics» занимается поставками электронных компонентов импортного и отечественного производства от производителей и со складов крупных дистрибьюторов Европы, Америки и Азии.

С конца 2013 года компания активно расширяет линейку поставок компонентов по направлению коаксиальный кабель, кварцевые генераторы и конденсаторы (керамические, пленочные, электролитические), за счёт заключения дистрибьюторских договоров

Мы предлагаем:

- Конкурентоспособные цены и скидки постоянным клиентам.
- Специальные условия для постоянных клиентов.
- Подбор аналогов.
- Поставку компонентов в любых объемах, удовлетворяющих вашим потребностям.
- Приемлемые сроки поставки, возможна ускоренная поставка.
- Доставку товара в любую точку России и стран СНГ.
- Комплексную поставку.
- Работу по проектам и поставку образцов.
- Формирование склада под заказчика.
- Сертификаты соответствия на поставляемую продукцию (по желанию клиента).
- Тестирование поставляемой продукции.
- Поставку компонентов, требующих военную и космическую приемку.
- Входной контроль качества.
- Наличие сертификата ISO.

В составе нашей компании организован Конструкторский отдел, призванный помогать разработчикам, и инженерам.

Конструкторский отдел помогает осуществить:

- Регистрацию проекта у производителя компонентов.
- Техническую поддержку проекта.
- Защиту от снятия компонента с производства.
- Оценку стоимости проекта по компонентам.
- Изготовление тестовой платы монтаж и пусконаладочные работы.



Тел: +7 (812) 336 43 04 (многоканальный)

Email: org@lifeelectronics.ru