

Features

- 3535 IR LED
- ROHS and REACH Compliant
- Vertical Patent Free Chip
- ESD 2KV

Applications

- IP Cam
- Security
- Industrial facility applications

Description

The IN-C33(X)TOIR is a high-power IR LED. It is a SMD type LED which can be used in various applications.



| Outline(mm) | | | |
|--------------|-------------|-------------|--------------|
| 30D | 60D | 120D | 90D |
| 3.5x3.5x3.38 | 3.5x3.5x2.8 | 3.5x3.5x2.0 | 3.5x3.5x2.34 |
| IN-C33ATOIR | IN-C33BTOIR | IN-C33CTOIR | IN-C33ETOIR |

Recommended Solder Pattern

(Suggest Stencil t=0.12 mm)

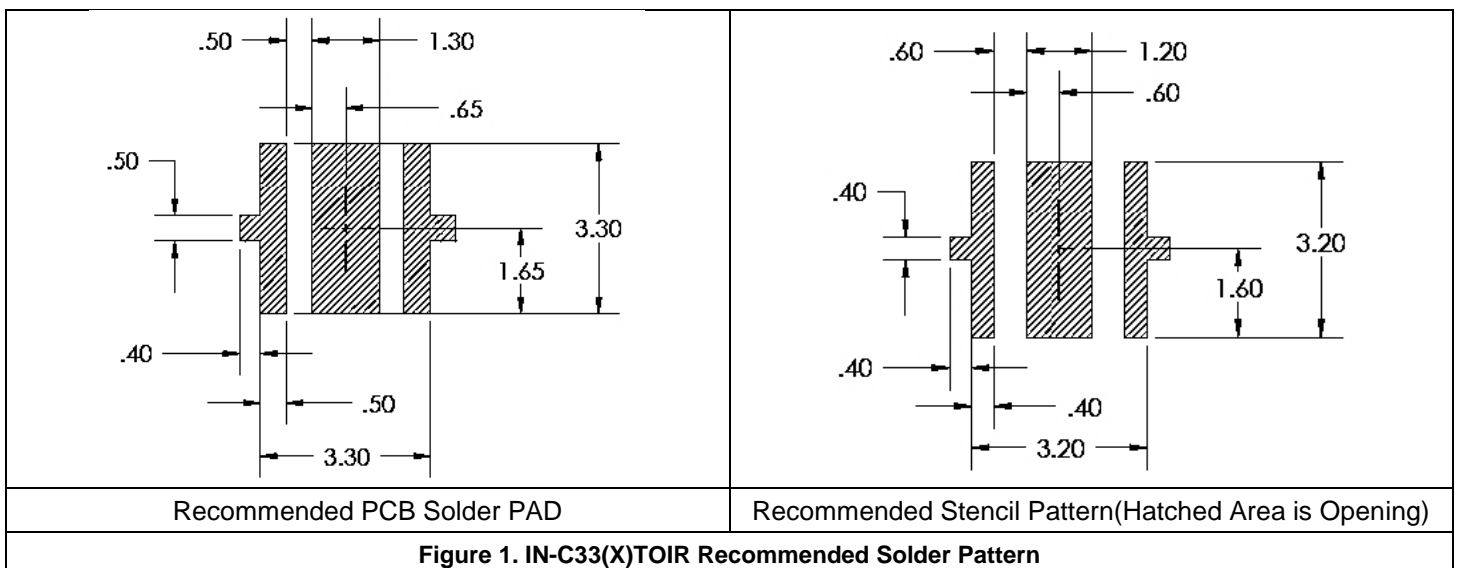

Package Dimensions

(All dimensions are in mm, tolerance is $\pm 0.13\text{mm}$)

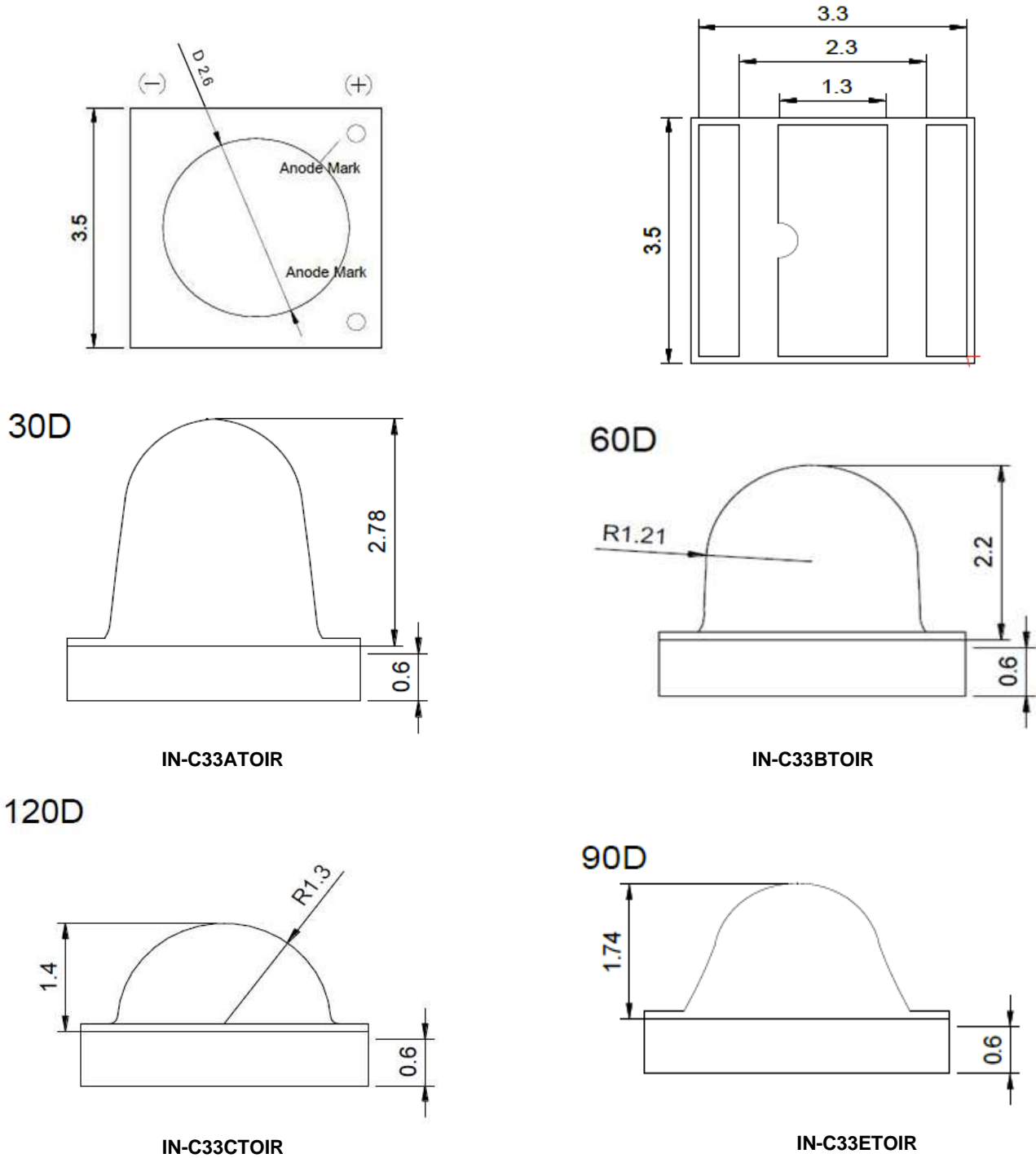

Figure 2. IN-C33(X)TOIR Package Dimension

Absolute Maximum Rating at 25°C (Note 1)

| Product | I _F (mA) max | I _{FP} * (mA) | V _R (V) | I _R (μA) max | T _J (°C) | T _{ST} (°C) | R _{th} (°C/W) | Soldering Temp. T _{sol} (°C) |
|--|----------------------------|------------------------|--------------------|----------------------------|---------------------|----------------------|------------------------|--|
| IN-C33ATOIR IN-C33BTOIR IN-C33CTOIR IN-C33ETOIR | 1000 | 1200 | -5 | 10 | 125 °C | -40°C~+100°C | 10 | 260 °C |

Notes

1. Condition for I_{FP} is pulse of 1/10 duty and 0.1msec width
2. When driving at maximum current the T_J must be kept below 125°C

Electrical Characteristics T_A = 25°C (Note 1)

| Product | V _F (V)@1000mA | | | Beam Angle | | | |
|--|---------------------------|------|-----|-------------|-------------|-------------|-------------|
| | min | typ. | max | IN-C33ATOIR | IN-C33BTOIR | IN-C33CTOIR | IN-C33ETOIR |
| IN-C33ATOIR IN-C33BTOIR IN-C33CTOIR IN-C33ETOIR | 1.4 | --- | 2.6 | 30 | 60 | 120 | 90 |

Notes

1. Performance guaranteed only under conditions listed in above tables.
2. Viewing angle(2θ1/2) ± 10°
3. Detail binning information on page 5.

ESD Precaution

ATTENTION: Electrostatic Discharge (ESD) protection



The symbol above denotes that ESD precaution is needed. ESD protection for GaP and AlGaAs based chips is necessary even though they are relatively safe in the presence of low static-electric discharge. Parts built with AlInGaP, GaN, or/and InGaN based chips are STATIC SENSITIVE devices. ESD precaution must be taken during design and assembly. If manual work or processing is needed, please ensure the device is adequately protected from ESD during the process.

Please be advised that normal static precautions should be taken in the handling and assembly of this device to prevent damage or degradation which may be induced by electrostatic discharge (ESD).

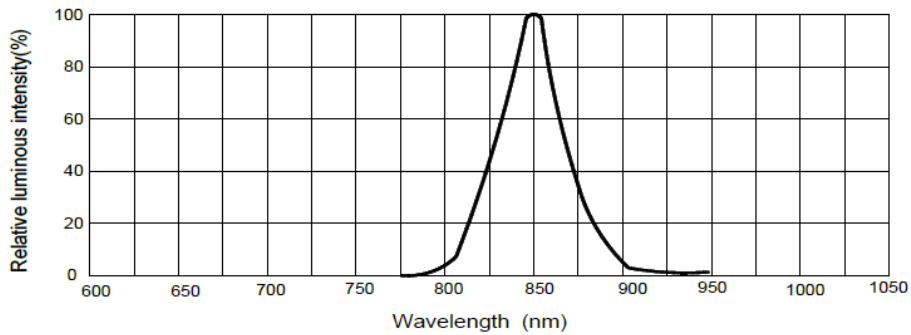
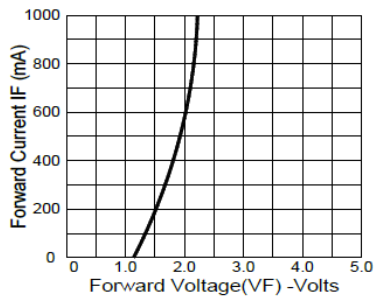
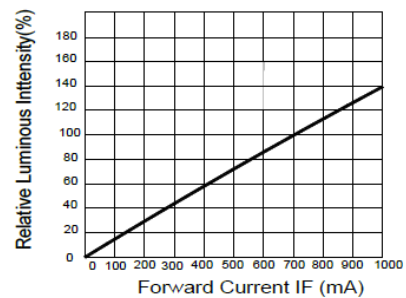
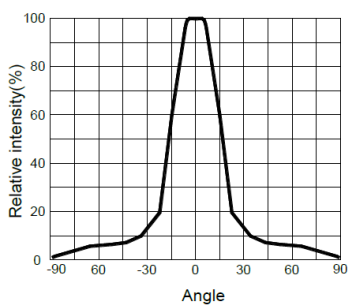
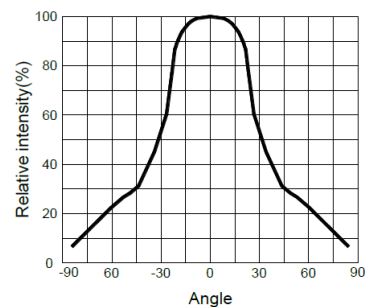
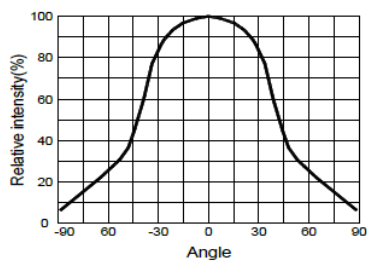
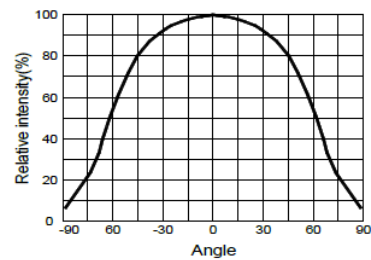
Electronic-Optical Characteristics
Spectrum Distribution

Forward Current VS. Forward Voltage

Luminous Intensity VS. Forward Current

Beam angle (2θ1/2)
Beam Angle 30D

Beam Angle 60D

Beam Angle 90D

Beam Angle 120D

Notes:

Viewing angle(2θ1/2) ± 10°

Ordering Information

| Orderable Part Number | Peak Wavelength (nm) | Radiometric Power (mW) @1000mA | | | Forward Voltage (V) | | Angle |
|-----------------------|----------------------|-----------------------------------|-----|-----|---------------------|-----|-------|
| | | Group | Min | Max | Min | Max | |
| IN-C33ATOIR | 840-850 | A | 450 | 500 | 1.6 | 1.8 | 30° |
| | | B | 500 | 550 | 1.8 | 2.0 | 30° |
| | 850-860 | C | 550 | 600 | 2.0 | 2.2 | 30° |
| | | D | 600 | 650 | 2.2 | 2.4 | 30° |
| IN-C33BTOIR | 840-850 | A | 450 | 500 | 1.6 | 1.8 | 60° |
| | | B | 500 | 550 | 1.8 | 2.0 | 60° |
| | 850-860 | C | 550 | 600 | 2.0 | 2.2 | 60° |
| | | D | 600 | 650 | 2.2 | 2.4 | 60° |
| IN-C33ETOIR | 840-850 | A | 450 | 500 | 1.6 | 1.8 | 90° |
| | | B | 500 | 550 | 1.8 | 2.0 | 90° |
| | 850-860 | C | 550 | 600 | 2.0 | 2.2 | 90° |
| | | D | 600 | 650 | 2.2 | 2.4 | 90° |
| IN-C33CTOIR | 840-850 | A | 450 | 500 | 1.6 | 1.8 | 120° |
| | | B | 500 | 550 | 1.8 | 2.0 | 120° |
| | 850-860 | C | 550 | 600 | 2.0 | 2.2 | 120° |
| | | D | 600 | 650 | 2.2 | 2.4 | 120° |

Note:

1. Forward voltage (V_F) $\pm 0.1V$, Radiometric Power (P_o) $\pm 10\%$.
2. Testing current of 5W is 1000mA

Label Specifications



Inolux P/N:

| I | N | - | C | 3 | 3 | | T | O | | IR | - | X | X | X | X |
|------------|---|---|------------------|---|---|-----------|---------------|------------|-----------------|------------|---|----------------------|---|---|---|
| | | | Material | Package | | Variation | Orientation | Current | Lens | Color | | Customized Stamp-off | | | |
| Inolux SMD | | | C = Ceramic Type | 33A = 3.5 x 3.5, 30 Deg. 33B = 3.5 x 3.5, 60 Deg. 33C = 3.5 x 3.5, 120 Deg. 33E = 3.5 x 3.5, 90 Deg. | | | T = Top Mount | O = 1000mA | (Blank) = Clear | IR = 850nm | | | | | |

Lot No.:

| | | | | | | | |
|------------------|--------------------------|---|---|---|-------|------|--------|
| Z | 2 | 0 | 1 | 7 | 01 | 24 | 001 |
| Internal Tracker | Year (2017, 2018,) | | | | Month | Date | Serial |

Reflow Soldering

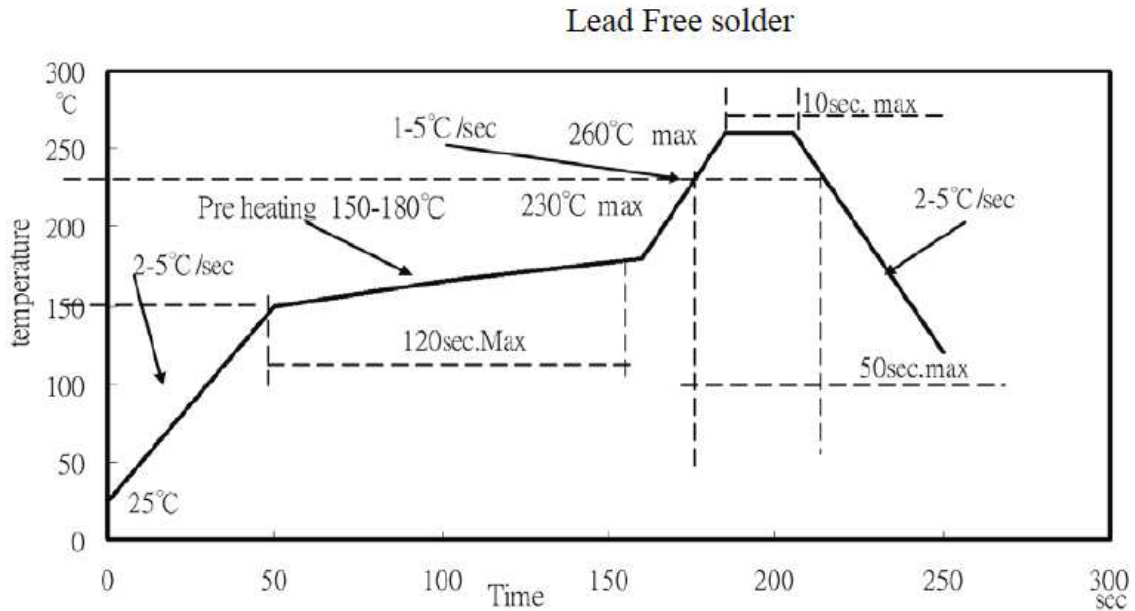

Soldering Iron

Basic Spec is ≤ 4 sec. when 260°C (+10°C → -1 second). Power dissipation of Iron should be less than 15W. Surface temperature should be under 230°C

Rework

Rework should be completed within 4 second under 245°C

Notes

1. Do not stress the silicone resin while it is exposed to high temperature.
2. The number of reflow process should not exceed 3 times.

Packing

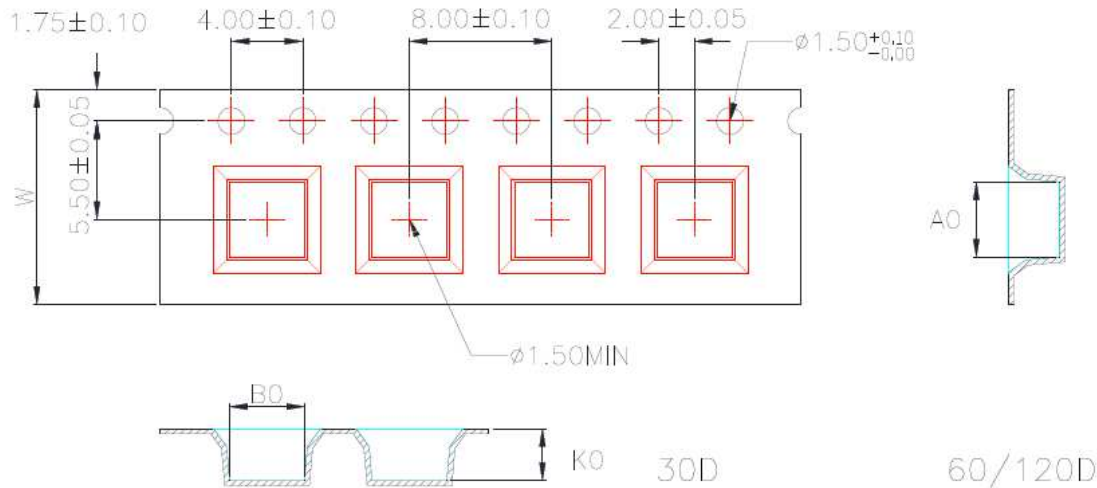

1. 10 sprocket hole pitch cumulative tolerance ± 0.20 .
2. Carrier camber is within 1 mm in 250 mm.
3. Material : Black Conductive Polystyrene Alloy.
4. All dimensions meet EIA-481-D requirements.
5. Thickness : 0.30 ± 0.05 mm.
6. Packing length per 22" reel : 62.5 Meters(1:3).
7. Component load per 7" reel : 400~1000 pcs.

30D

| | |
|----|------------|
| W | 12.00±0.30 |
| A0 | 4.20±0.10 |
| B0 | 4.20±0.10 |
| K0 | 3.50±0.10 |

60/120D

| | |
|----|------------|
| W | 12.00±0.30 |
| A0 | 4.20±0.10 |
| B0 | 4.20±0.10 |
| K0 | 2.90±0.10 |

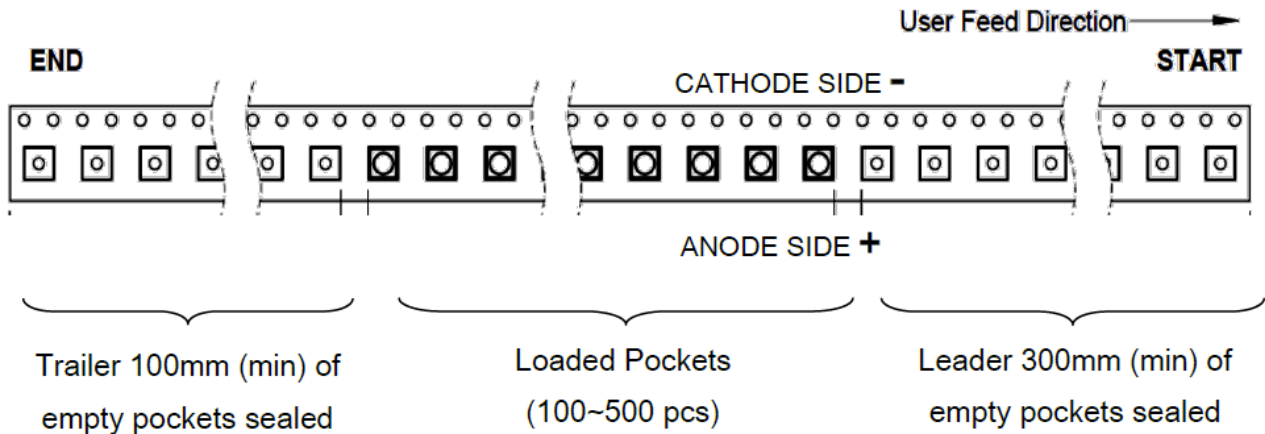

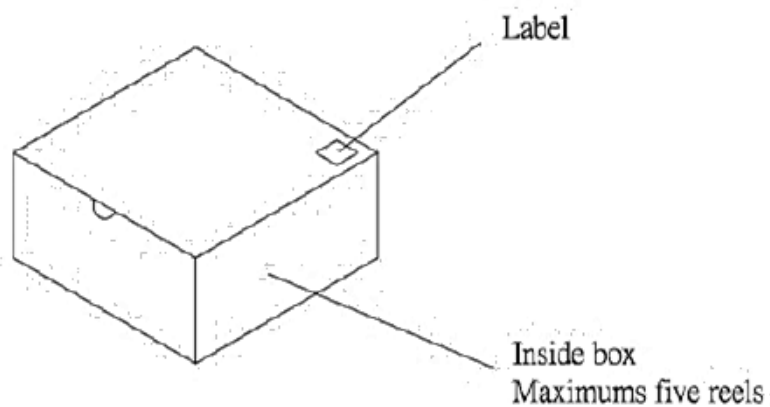
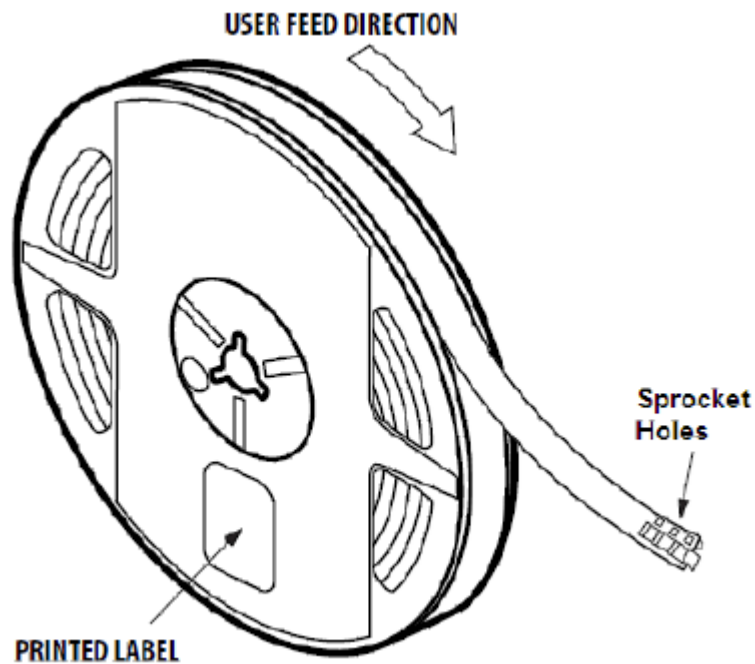

Notes:

1. Each Reel (minimum number of pieces is 100 and maximum is 500 (60D)/1000 (120D) is packed in a moisture-proof bag along with 2 packs of desiccant and a humidity indicator card;
2. A maximum of 5 moisture-proof bags are packed in an inner box (size: 240mm x 200mm x 105mm \pm 5mm)
3. A maximum of 4 inner boxes are put in an outer box (size: 410mm x 255mm x 230mm \pm 5mm)
4. Part No., Lot No., quantity should be indicated on the label of the moisture-proof bag and the cardboard box.

Precautions

1. Recommendation for using LEDs

1.1 The lens of LEDs should not be exposed to dust or debris. Excessive dust and debris may cause a drastic decrease in the luminosity.

1.2 Avoid mechanical stress on LED lens.

1.3 Do not touch the LED lens surface. It would affect the optical performance of the LED due to the LED lens' damage.

1.4 Pick & place tools are recommended for the remove of LEDs from the factory tape & reel packaging

2. Pick & place nozzle

The pickup tool was recommended and shown as below

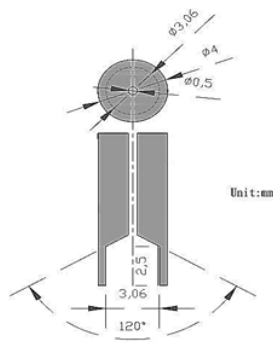

3. Lens handling

Please follow the guideline to pick LEDs

3.1 Use tweezers to pick LEDs

3.2 Do not touch the lens by using tweezers

3.3 Do not touch lens with fingers

3.4 Do not apply more than 4N of lens (400g) directly onto the lens

4. Lens cleaning

In the case which a small amount of dirt and dust particles remain on the lens surface, a suitable cleaning solution can be applied.

4.1 Try a gentle wiping with dust-free cloth

4.2 If needed, use dust-free cloth and isopropyl alcohol to gently clean the dirt from the lens surface.

4.3 Do not use other solvents as they may directly react with the LED assembly

4.4 Do not use ultrasonic cleaning which will damage the LEDs

Test Items and Results of Reliability

| Test Item | Test Conditions | Duration/ Cycle | Number of Damage | Reference |
|------------------------------|--------------------------------------|--------------------|---------------------|-----------------------------|
| Thermal Shock | -40°C 30min ↑↓5min 125°C 30min | 100 cycles | 0/22 | AECQ101 |
| High Temperature Storage | Ta=100°C | 1000 hrs | 0/22 | EIAJ ED-4701 200 201 |
| Humidity Heat Storage | Ta=85°C RH=85% | 1000 hrs | 0/22 | EIAJ ED-4701 100 103 |
| Low Temperature Storage | Ta=-40°C | 1000 hrs | 0/22 | EIAJ ED-4701 200 202 |
| Life Test | Ta=25°C If=700mA | 1000 hrs | 0/22 | Tested with UVT standard |
| High Humidity Heat Life Test | 85°C RH=85% If=700mA | 1000 hrs | 0/22 | Tested with UVT standard |
| High Temperature Life Test | Ta=85°C | 1000 hrs | 0/22 | Tested with UVT standard |
| ESD(HBM) | 2KV at 1.5kΩ;100pf | 3 Times | 0/22 | MIL-STD-883 |

| Criteria for Judging the Damage | | | | |
|---------------------------------|--------|-----------|-----------------------|-----------------------|
| Item | Symbol | Condition | Criteria for Judgment | |
| | | | Min | Max |
| Forward Voltage | VF | If=700mA | - | USL ¹ ×1.1 |
| Reverse Current | IR | VR =5V | - | 100μA |
| Luminous Intensity | Iv | If=700mA | LSL ² ×0.7 | - |

Notes:

1. USL: Upper specification level
2. LSL: Lower specification level

Revision History

| Changes since last revision | Page | Version No. | Revision Date |
|-----------------------------|------|-------------|---------------|
| Initial Release | | 1.0 | 04-16-2018 |
| Format Adjustment | | 1.1 | 12-03-2018 |
| | | | |
| | | | |
| | | | |
| | | | |
| | | | |
| | | | |
| | | | |

DISCLAIMER

INOLUX reserves the right to make changes without further notice to any products herein to improve reliability, function or design. INOLUX does not assume any liability arising out of the application or use of any product or circuit described herein; neither does it convey any license under its patent rights, nor the rights of others.

LIFE SUPPORT POLICY

INOLUX's products are not authorized for use as critical components in life support devices or systems without the express written approval of the President of INOLUX or INOLUX CORPORATION. As used herein:

1. Life support devices or systems are devices or systems which, (a) are intended for surgical implant into the body, or (b) support or sustain life, and (c) whose failure to perform when properly used in accordance with instructions for use provided in the labeling, can be reasonably expected to result in a significant injury of the user.
2. A critical component in any component of a life support device or system whose failure to perform can be reasonably expected to cause the failure of the life support device or system, or to affect its safety or effectiveness.

Компания «Life Electronics» занимается поставками электронных компонентов импортного и отечественного производства от производителей и со складов крупных дистрибьюторов Европы, Америки и Азии.

С конца 2013 года компания активно расширяет линейку поставок компонентов по направлению коаксиальный кабель, кварцевые генераторы и конденсаторы (керамические, пленочные, электролитические), за счёт заключения дистрибьюторских договоров

Мы предлагаем:

- Конкурентоспособные цены и скидки постоянным клиентам.
- Специальные условия для постоянных клиентов.
- Подбор аналогов.
- Поставку компонентов в любых объемах, удовлетворяющих вашим потребностям.
- Приемлемые сроки поставки, возможна ускоренная поставка.
- Доставку товара в любую точку России и стран СНГ.
- Комплексную поставку.
- Работу по проектам и поставку образцов.
- Формирование склада под заказчика.
- Сертификаты соответствия на поставляемую продукцию (по желанию клиента).
- Тестирование поставляемой продукции.
- Поставку компонентов, требующих военную и космическую приемку.
- Входной контроль качества.
- Наличие сертификата ISO.

В составе нашей компании организован Конструкторский отдел, призванный помогать разработчикам, и инженерам.

Конструкторский отдел помогает осуществить:

- Регистрацию проекта у производителя компонентов.
- Техническую поддержку проекта.
- Защиту от снятия компонента с производства.
- Оценку стоимости проекта по компонентам.
- Изготовление тестовой платы монтаж и пусконаладочные работы.



Тел: +7 (812) 336 43 04 (многоканальный)

Email: org@lifeelectronics.ru