



00-9159-00X-501-X06

PREFIX

SERIES

NO. OF WAYS

CODE	NO. OF WAYS	DETAILS
002	2	SHEET 2
003	3	SHEET 3
004	4	SHEET 4
005	5	SHEET 5
006	6	SHEET 6

Elco Europe (A Division of AVX Ltd) CONFIDENTIAL PROPRIETY  
 The document on this print and information therewith are PROPRIETY  
 to Elco Europe (A Division of AVX Ltd) and shall not be copied  
 or disclosed in whole or in part without Elco Europe's written consent.

SINGLE PART PCB STRIP CONNECTOR

CODE	DESCRIPTION	DETAILS
501	THROUGH THE BOARD - EDGE CARD - NO CAP	SHEETS 2 TO 6
502	THROUGH THE BOARD - EDGE CARD - CAP FITTED	SHEET 7

INSULATOR COLOUR

CODE	COLOUR	AVAILABILITY
9	WHITE	UL APPROVED - STANDARD



PLATING OPTION

CODE	CONTACT PLATING
06	GOLD PLATING ON NOSE WITH TIN ON TAILS

SHEET 1 OF 10

FORM-106-01-056-6 ISS 7

Release No.	102809
History	10.11.2011
	06.01.2012
	12.01.2012
	03.02.2012
	08.02.2012
	08.03.2012
	28.03.2012
	102876
	26.04.2012
	102879
	14.05.2012
	26.06.2012
	24.07.2012



Drawn	N.C.H.	Description	9159 THROUGH BOARD - ORDERING CODE	DATE	06-Jan-12
Size	CV	Part Number	00-9159-01_500S	Issue	6

DATE	06-Jan-12
Issue	6



**THROUGH THE BOARD MATING EDGE CARD CONNECTOR - 2 WAY**



**SECTION A-A**

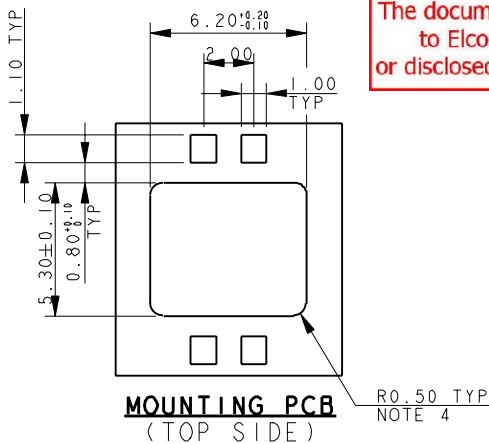

Elco Europe (A Division of AVX Ltd) CONFIDENTIAL PROPRIETY  
The document on this print and information therewith are PROPRIETY  
to Elco Europe (A Division of AVX Ltd) and shall not be copied  
or disclosed in whole or in part without Elco Europe's written consent.

**PACKING DETAILS**

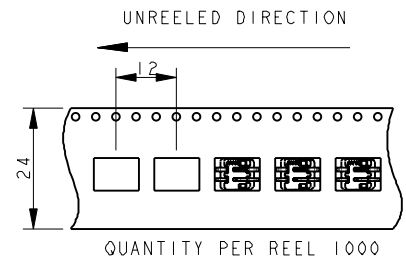
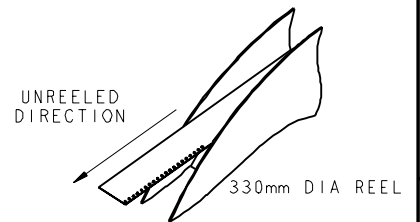

**NOTES :-**

1. THROUGH THE BOARD 2 WAY EDGE CARD CONNECTOR. FOR FURTHER DETAILS REFER TO PRODUCT SPECIFICATION 201-01-136.
2. FOR MATING PCB EITHER 0.8mm OR 1.6mm THICK. REFER TO SHEET 7 FOR MATING PCB DETAILS.
3. CONNECTOR TOP MOUNTING ON PCB.
4. UP TO 0.5mm RAD TO MATCH CONNECTOR PROFILE.
5. ALL DIMENSIONS ±0.20 UNLESS TOLERANCE SPECIFIED.
6. INSULATOR :- PA4T, GLASS FILLED, HALOGEN FREE, UL94 V-0, COLOUR REFER TO SHEET 1.
7. CONTACT :- COPPER ALLOY, NICKEL PLATED WITH GOLD FLASH ON NOSE AND TIN ON TAILS.
8. BRACKET :- COPPER ALLOY, PLATING, TIN OVER NICKEL.
9. PACKING IN TAPE AND REEL, 1000 PIECES PER REEL.
10. CONTACT TAILS COPLANARITY WITHIN 0.10.
11. REFER TO SHEET 10 FOR MATCHING PROTECTING CAP.
12. UL REFERENCE E90723.

ELCO EUROPE (A DIVISION OF AVX LTD.) CONFIDENTIAL PROPRIETARY  
THE DRAWING ON THIS PRINT AND INFORMATION THEREWITH ARE PROPRIETARY TO ELCO EUROPE (A DIVISION OF AVX LTD.) AND SHALL NOT BE USED OR DISCLOSED IN WHOLE OR IN PART WITHOUT ELCO EUROPE'S WRITTEN CONSENT.

Release No.	102809
History	10.11.2011
	06.01.2012
	12.01.2012
	03.02.2012
	08.02.2012
	08.03.2012
	28.03.2012
	102876
	26.04.2012
	102879
	14.03.2012
	15.03.2012
	26.06.2012
	24.07.2012

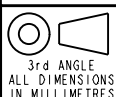

**ELCO**  
© COPYRIGHT ELCO EUROPE  
NOT TO BE DISCLOSED OR COPIED  
WITHOUT WRITTEN PERMISSION

Drawn	N.C.H.	Description	9159 THROUGH BOARD - ORDERING CODE	DATE	06-Jan-12
Size	CV	Part Number	00-9159-01_500S	Issue	6

SHEET 2 OF 10



**THROUGH THE BOARD MATING EDGE CARD CONNECTOR - 3 WAY**

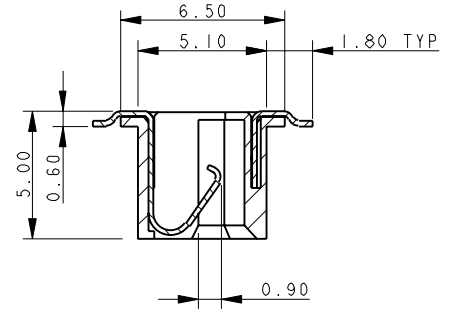
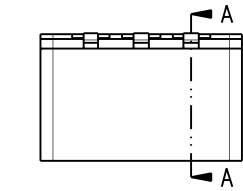

**SECTION A-A**

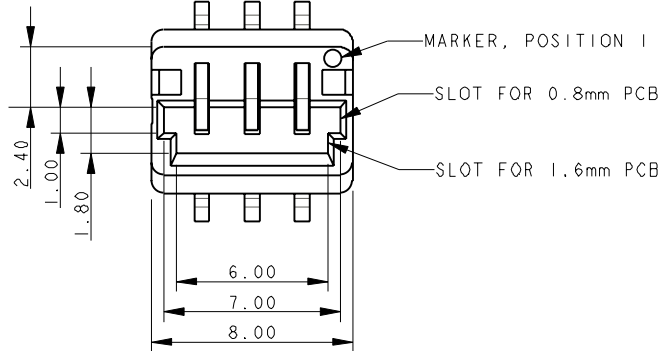

Elco Europe (A Division of AVX Ltd) CONFIDENTIAL PROPRIETY  
The document on this print and information therewith are PROPRIETY to Elco Europe (A Division of AVX Ltd) and shall not be copied or disclosed in whole or in part without Elco Europe's written consent.

**PACKING DETAILS**



- NOTES :-
1. THROUGH THE BOARD 3 WAY EDGE CARD CONNECTOR.
  2. FOR FURTHER DETAILS REFER TO PRODUCT SPECIFICATION 201-01-136.
  3. FOR MATING PCB EITHER 0.8mm OR 1.6mm THICK. REFER TO SHEET 7 FOR MATING PCB DETAILS.
  4. CONNECTOR TOP MOUNTING ON PCB.
  5. UP TO 0.5mm RAD TO MATCH CONNECTOR PROFILE.
  6. ALL DIMENSIONS ±0.20 UNLESS TOLERANCE SPECIFIED.
  7. INSULATOR :- PA4T, GLASS FILLED, HALOGEN FREE, UL94 V-0, COLOUR REFER TO SHEET 1.
  8. CONTACT :- COPPER ALLOY, NICKEL PLATED WITH GOLD FLASH ON NOSE AND TIN ON TAILS.
  9. BRACKET :- COPPER ALLOY, PLATING, TIN OVER NICKEL.
  10. PACKING IN TAPE AND REEL, 1000 PIECES PER REEL.
  11. CONTACT TAILS COPLANARITY WITHIN 0.10.
  12. REFER TO SHEET 10 FOR MATCHING PROTECTING CAP.
  13. UL REFERENCE E90723.

ELCO EUROPE (A DIVISION OF AVX LTD.) CONFIDENTIAL PROPRIETY  
THE DRAWING ON THIS PRINT AND INFORMATION THEREWITH ARE PROPRIETARY TO ELCO EUROPE (A DIVISION OF AVX LTD.) AND SHALL NOT BE USED OR DISCLOSED IN WHOLE OR IN PART WITHOUT ELCO EUROPE'S WRITTEN CONSENT.

Release No.	102809
History	10.11.2011
	06.01.2012
	12.01.2012
	03.02.2012
	08.02.2012
	08.03.2012
	28.03.2012
	102876
	26.04.2012
	102879
	14.03.2012
	26.06.2012
	24.07.2012

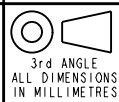

Drawn	N.C.H.	Description	9159 THROUGH BOARD - ORDERING CODE	DATE	06-Jan-12
Size	CV	Part Number	00-9159-01_500S	Issue	6

SHEET 3 OF 10

FORM-106-01-056-6 ISS 7



**THROUGH THE BOARD MATING EDGE CARD CONNECTOR - 4 WAY**

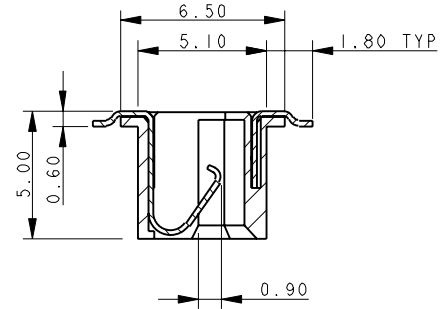
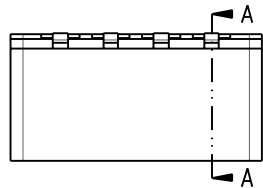

**SECTION A-A**

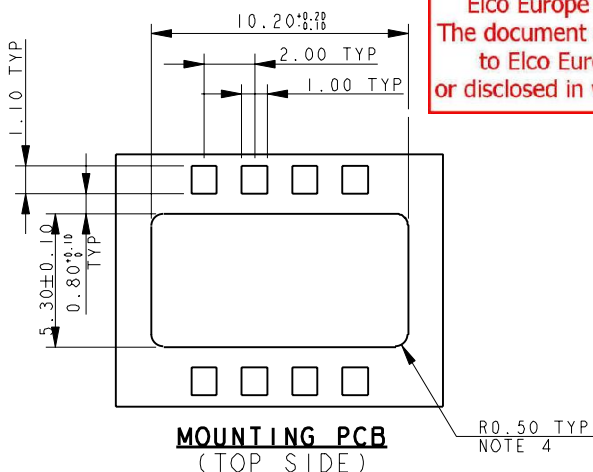
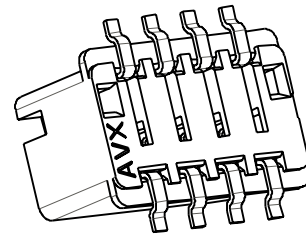
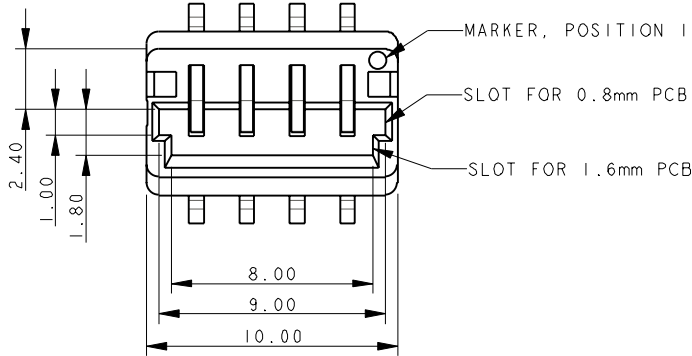

Elco Europe (A Division of AVX Ltd) CONFIDENTIAL PROPRIETY  
The document on this print and information therewith are PROPRIETY  
to Elco Europe (A Division of AVX Ltd) and shall not be copied  
or disclosed in whole or in part without Elco Europe's written consent.

**PACKING DETAILS**

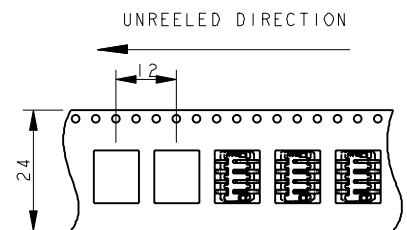
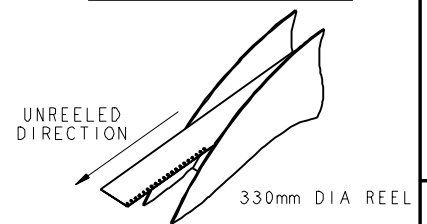

QUANTITY PER REEL 1000

**NOTES :-**

1. THROUGH THE BOARD 4 WAY EDGE CARD CONNECTOR.
2. FOR FURTHER DETAILS REFER TO PRODUCT SPECIFICATION 201-01-136.
3. FOR MATING PCB EITHER 0.8mm OR 1.6mm THICK. REFER TO SHEET 7 FOR MATING PCB DETAILS.
4. CONNECTOR TOP MOUNTING ON PCB.
5. UP TO 0.5mm RAD TO MATCH CONNECTOR PROFILE.
6. ALL DIMENSIONS ±0.20 UNLESS TOLERANCE SPECIFIED.
7. INSULATOR :- PA4T, GLASS FILLED, HALOGEN FREE, UL94 V-0, COLOUR REFER TO SHEET 1.
8. CONTACT :- COPPER ALLOY, NICKEL PLATED WITH GOLD FLASH ON NOSE AND TIN ON TAILS.
9. BRACKET :- COPPER ALLOY, PLATING, TIN OVER NICKEL.
10. PACKING IN TAPE AND REEL, 1000 PIECES PER REEL.
11. CONTACT TAILS COPLANARITY WITHIN 0.10.
12. REFER TO SHEET 10 FOR MATCHING PROTECTING CAP.
13. UL REFERENCE E90723.

ELCO EUROPE (A DIVISION OF AVX LTD.) CONFIDENTIAL PROPRIETARY  
THE DRAWING ON THIS PRINT AND INFORMATION THEREWITH ARE PROPRIETARY TO ELCO EUROPE (A DIVISION OF AVX LTD.) AND SHALL NOT BE USED OR DISCLOSED IN WHOLE OR IN PART WITHOUT ELCO EUROPE'S WRITTEN CONSENT.

Release No.	102809
History	10.11.2011
	06.01.2012
	12.01.2012
	03.02.2012
	08.02.2012
	08.03.2012
	28.03.2012
	102876
	26.04.2012
	102879
	14.03.2012
	15.03.2012
	26.06.2012
	24.07.2012

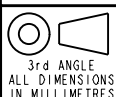

Drawn	N.C.H.
Size	CV

Description	9159 THROUGH BOARD - ORDERING CODE
Part Number	00-9159-01_500S

DATE	06-Jan-12
Issue	6

FORM-106-01-056-6 ISS 7



**THROUGH THE BOARD MATING EDGE CARD CONNECTOR - 5 WAY**

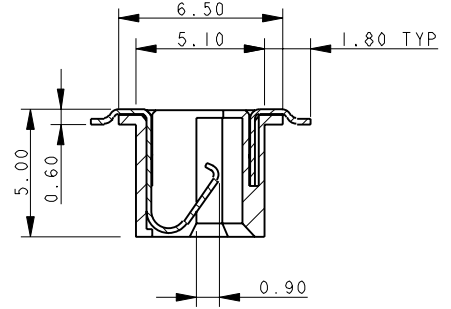
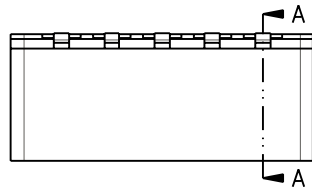

**SECTION A-A**

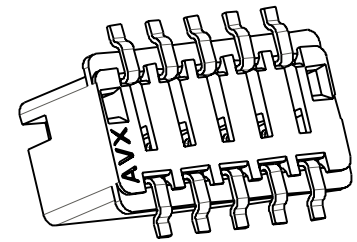
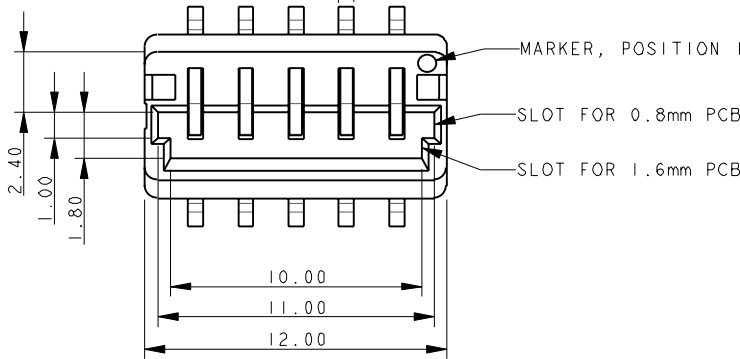

Elco Europe (A Division of AVX Ltd) CONFIDENTIAL PROPRIETY  
The document on this print and information therewith are PROPRIETY  
to Elco Europe (A Division of AVX Ltd) and shall not be copied  
or disclosed in whole or in part without Elco Europe's written consent.

**PACKING DETAILS**

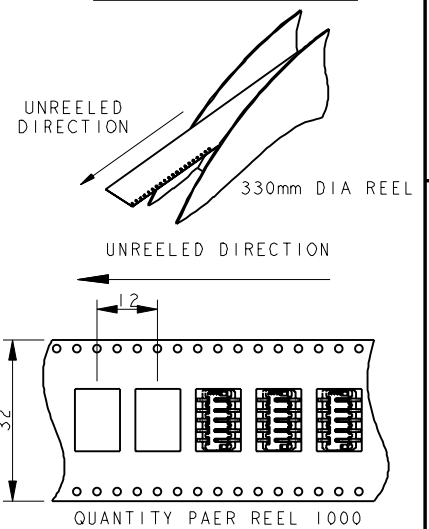

**NOTES :-**

1. THROUGH THE BOARD 5 WAY EDGE CARD CONNECTOR. FOR FURTHER DETAILS REFER TO PRODUCT SPECIFICATION 201-01-136.
2. FOR MATING PCB EITHER 0.8mm OR 1.6mm THICK. REFER TO SHEET 7 FOR MATING PCB DETAILS.
3. CONNECTOR TOP MOUNTING ON PCB.
4. UP TO 0.5mm RAD TO MATCH CONNECTOR PROFILE.
5. ALL DIMENSIONS ±0.20 UNLESS TOLERANCE SPECIFIED.
6. INSULATOR :- PA4T, GLASS FILLED, HALOGEN FREE, UL94 V-0, COLOUR REFER TO SHEET 1.
7. CONTACT :- COPPER ALLOY, NICKEL PLATED WITH GOLD FLASH ON NOSE AND TIN ON TAILS.
8. BRACKET :- COPPER ALLOY, PLATING, TIN OVER NICKEL.
9. PACKING IN TAPE AND REEL, 1000 PIECES PER REEL.
10. CONTACT TAILS COPLANARITY WITHIN 0.10.
11. REFER TO SHEET 10 FOR MATCHING PROTECTING CAP.
12. UL REFERENCE E90723.

ELCO EUROPE (A DIVISION OF AVX LTD.) CONFIDENTIAL PROPRIETY  
THE DRAWING ON THIS PRINT AND INFORMATION THEREWITH ARE PROPRIETARY TO ELCO EUROPE (A DIVISION OF AVX LTD.) AND SHALL NOT BE USED OR DISCLOSED IN WHOLE OR IN PART WITHOUT ELCO EUROPE'S WRITTEN CONSENT.

Release No.	102809
History	10.11.2011
	06.01.2012
	12.01.2012
	03.02.2012
	08.02.2012
	08.03.2012
	28.03.2012
	102876
	26.04.2012
	102879
	14.03.2012
	15.03.2012
	26.06.2012
	24.07.2012

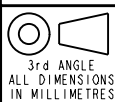

Drawn	N.C.H.	Description	9159 THROUGH BOARD - ORDERING CODE	DATE	06-Jan-12
Size	CV	Part Number	00-9159-01_500S	Issue	6

FORM-106-01-056-6 ISS 7



**THROUGH THE BOARD MATING EDGE CARD CONNECTOR - 6 WAY**

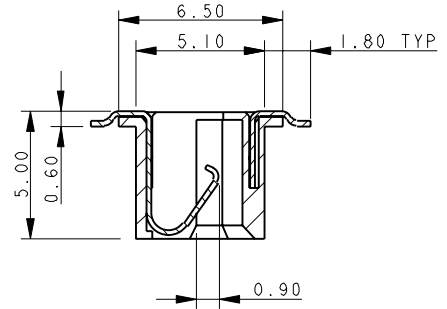
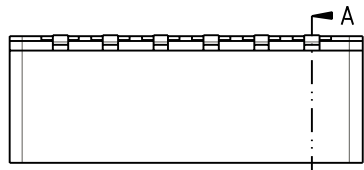

**SECTION A-A**

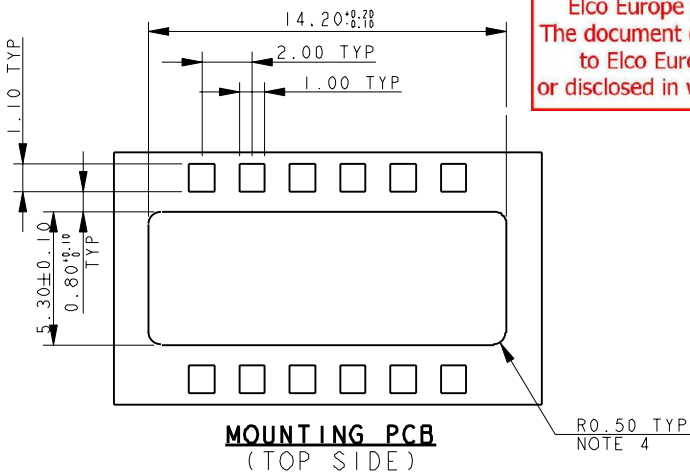
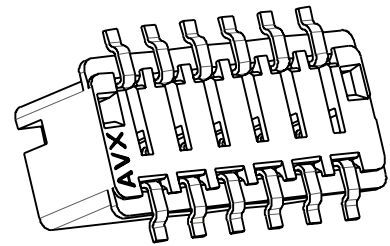
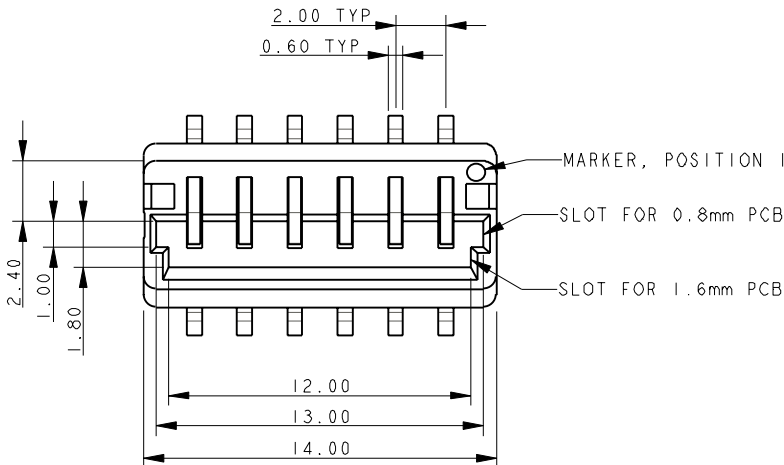

Elco Europe (A Division of AVX Ltd) CONFIDENTIAL PROPRIETY  
The document on this print and information therewith are PROPRIETY  
to Elco Europe (A Division of AVX Ltd) and shall not be copied  
or disclosed in whole or in part without Elco Europe's written consent.

**PACKING DETAILS**

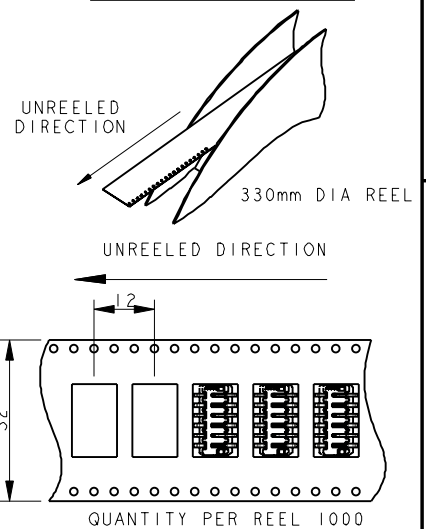

**NOTES :-**

1. THROUGH THE BOARD 6 WAY EDGE CARD CONNECTOR.
2. FOR FURTHER DETAILS REFER TO PRODUCT SPECIFICATION 201-01-136.
3. FOR MATING PCB EITHER 0.8mm OR 1.6mm THICK. REFER TO SHEET 7 FOR MATING PCB DETAILS.
4. CONNECTOR TOP MOUNTING ON PCB.
5. UP TO 0.5mm RAD TO MATCH CONNECTOR PROFILE.
6. ALL DIMENSIONS ±0.20 UNLESS TOLERANCE SPECIFIED.
7. INSULATOR :- PA4T, GLASS FILLED, HALOGEN FREE, UL94 V-0, COLOUR REFER TO SHEET 1.
8. CONTACT :- COPPER ALLOY, NICKEL PLATED WITH GOLD FLASH ON NOSE AND TIN ON TAILS.
9. BRACKET :- COPPER ALLOY, PLATING, TIN OVER NICKEL.
10. PACKING IN TAPE AND REEL, 1000 PICES PER REEL.
11. CONTACT TAILS COPLANARITY WITHIN 0.10.
12. REFER TO SHEET 10 FOR MATCHING PROTECTING CAP.
13. UL REFERENCE E90723.

ELCO EUROPE (A DIVISION OF AVX LTD.) CONFIDENTIAL PROPRIETARY  
THE DRAWING ON THIS PRINT AND INFORMATION THEREWITH ARE PROPRIETARY TO ELCO EUROPE (A DIVISION OF AVX LTD.) AND SHALL NOT BE USED OR DISCLOSED IN WHOLE OR IN PART WITHOUT ELCO EUROPE'S WRITTEN CONSENT.

Release No.	102809
History	10.11.2011
	06.01.2012
	12.01.2012
	08.02.2012
	08.03.2012
	28.03.2012
	26.04.2012
	102879
	14.03.2012
	15.06.2012
	26.06.2012
	24.07.2012

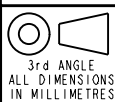

Drawn	N.C.H.	Description	9159 THROUGH BOARD - ORDERING CODE	DATE	06-Jan-12
Size	CV	Part Number	00-9159-01_500S	Issue	6

SHEET 6 OF 10

FORM-106-01-056-6 ISS 7

**THROUGH THE BOARD MATING EDGE CARD CONNECTOR - WITH CAP**  
**00-9159-00X-502-X06**

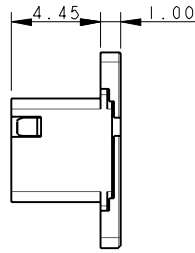
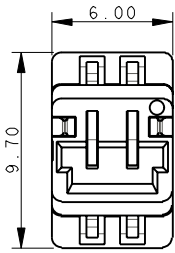

**00-9159-002-502-906**

Elco Europe (A Division of AVX Ltd) CONFIDENTIAL PROPRIETY  
 The document on this print and information therewith are PROPRIETY  
 to Elco Europe (A Division of AVX Ltd) and shall not be copied  
 or disclosed in whole or in part without Elco Europe's written consent.

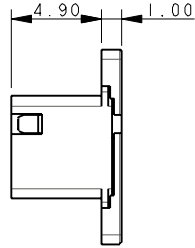
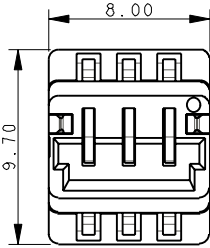

**00-9159-003-502-906**

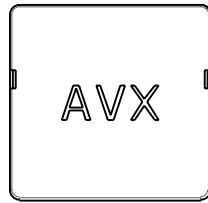
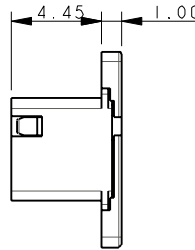
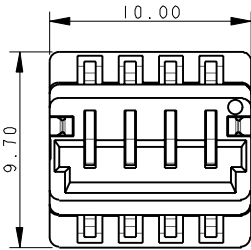

**00-9159-004-502-906**

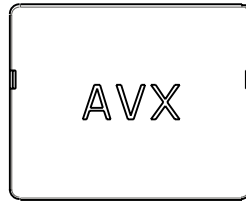
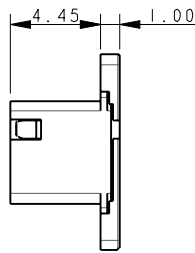
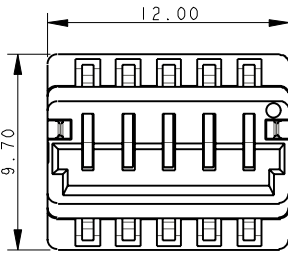

**00-9159-005-502-906**

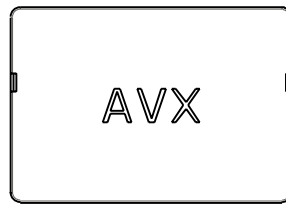
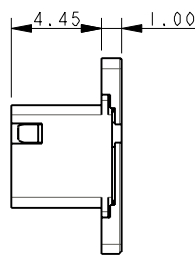
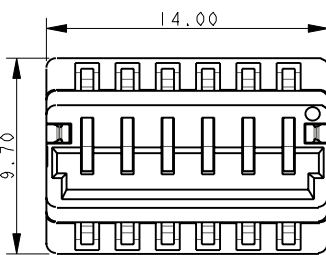

**00-9159-006-502-906**

**NOTES :-**

1. 00-9159-00X-501-X06 WITH CAP SUPPLIED FITTED.
2. DRAWINGS SHOW OUTLINE DIMENSIONS OF THE 00-9159-00X-502-X06 ASSEMBLIES, ALL OTHER DETAILS ARE AS 00-9159-00X-501-X06 ON SHEETS 2 TO 6.
3. GENERAL TOLERANCE  $\pm 0.20$ .
4. PACKING ORIENTATION.
12. UL REFERENCE E90723.



**RoHS  
COMPLIANT**

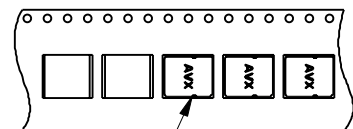

NOTE 4

ELCO EUROPE (A DIVISION OF AVX LTD.) CONFIDENTIAL PROPRIETARY  
 THE DRAWING ON THIS PRINT AND INFORMATION THEREWITH ARE  
 PROPRIETARY TO ELCO EUROPE (A DIVISION OF AVX LTD.) AND  
 SHALL NOT BE USED OR DISCLOSED IN WHOLE OR IN PART  
 WITHOUT ELCO EUROPE'S WRITTEN CONSENT.

SHEET 7 OF 10

Release No.	102809
History	03.02.2012
	08.02.2012
	28.03.2012
	102876
	26.04.2012
	102879
	14.05.2012
	15.06.2012
	26.06.2012
	24.07.2012

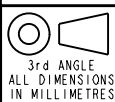

**ELCO**  
 © COPYRIGHT ELCO EUROPE  
 NOT TO BE DISCLOSED OR COPIED  
 WITHOUT WRITTEN PERMISSION

Drawn  
N.C.H.  
Size  
CV

Description  
9159 THROUGH BOARD - ORDERING CODE  
Part Number  
00-9159-01\_500S

DATE  
06-Jan-12  
Issue  
6

THROUGH THE BOARD MATING EDGE CARD CONNECTOR - MATING PCB

MATING PCB - 0.8mm PCB

MATING PCB - 1.6mm PCB



Elco Europe (A Division of AVX Ltd) CONFIDENTIAL PROPRIETARY  
 The document on this print and information therewith are PROPRIETY  
 to Elco Europe (A Division of AVX Ltd) and shall not be copied  
 or disclosed in whole or in part without Elco Europe's written consent.

- NOTES :-
1. CORRECT DIMENSIONS FOR EITHER 0.80mm OR 1.60mm PCB THICKNESS MUST BE USED.
  2. THICKNESS OF PCB INCLUDES ALL LAYERS INCLUDING COPPER AND PLATING.
  3. PADS TO BE PLATED GOLD OVER NICKEL UNDERCOAT.
  4. GENERAL TOLERANCE ±0.10 UNLESS STATED.



ELCO EUROPE (A DIVISION OF AVX LTD.) CONFIDENTIAL PROPRIETARY  
 THE DRAWING ON THIS PRINT AND INFORMATION THEREWITH ARE  
 PROPRIETARY TO ELCO EUROPE (A DIVISION OF AVX LTD.) AND  
 SHALL NOT BE USED OR DISCLOSED IN WHOLE OR IN PART  
 WITHOUT ELCO EUROPE'S WRITTEN CONSENT.

Release No.
102809
10.11.2011
06.01.2012
12.01.2012
03.02.2012
08.02.2012
28.03.2012
102876
26.04.2012
102879
14.03.2012
15.03.2012
26.06.2012
24.07.2012

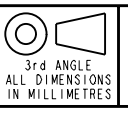

Drawn	N.C.H.	Description	9159 THROUGH BOARD - ORDERING CODE	DATE	06-Jan-12
Size	CV	Part Number	00-9159-01_500S	Issue	6





**THROUGH THE BOARD MATING EDGE CARD CONNECTOR**

**Elco Europe (A Division of AVX Ltd) CONFIDENTIAL PROPRIETY**  
**The document on this print and information therewith are PROPRIETY**  
**to Elco Europe (A Division of AVX Ltd) and shall not be copied**  
**or disclosed in whole or in part without Elco Europe's written consent.**

**CONNECTOR/PCB ASSEMBLY**  
**0.8mm MATING PCB**  
**NO CAP**

**CONNECTOR/PCB ASSEMBLY**  
**1.6mm MATING PCB**  
**WITH CAP**

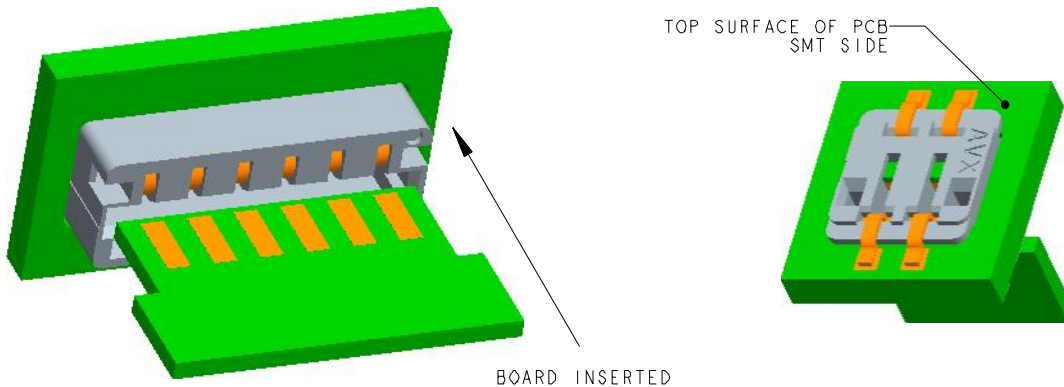
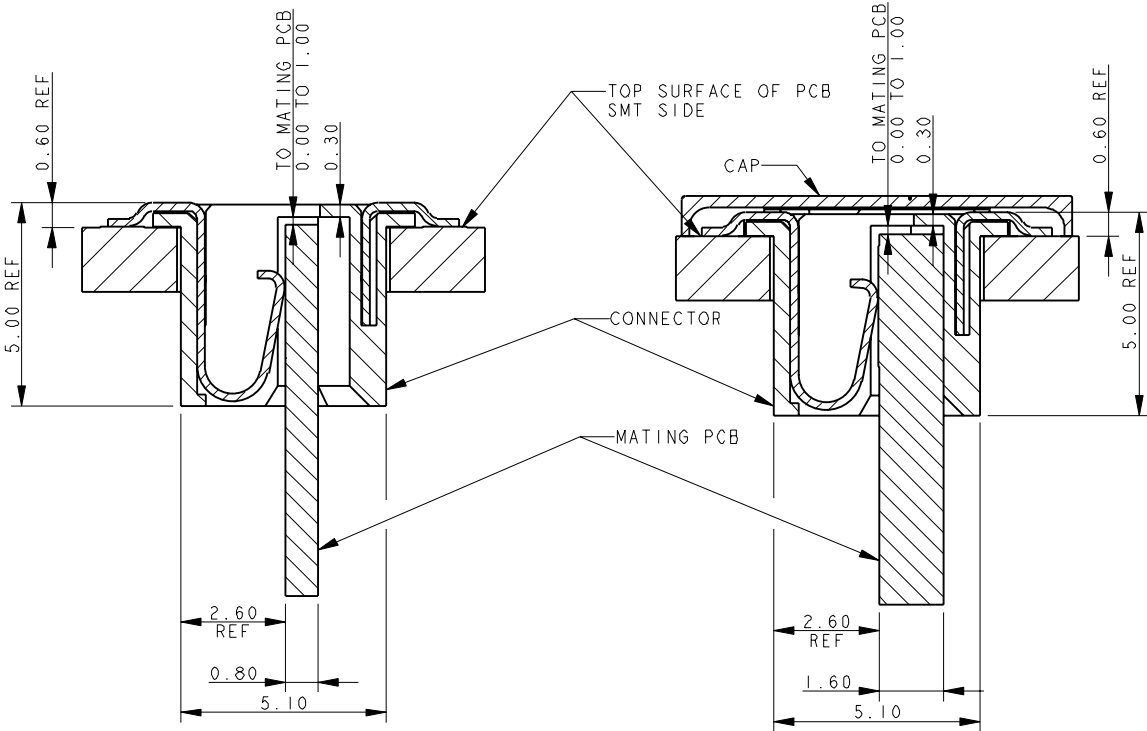

**NOTES :-**

1. THROUGH THE BOARD EDGE CARD CONNECTOR.
2. FOR MATING PCB EITHER 0.8mm OR 1.6mm THICK. REFER TO SHEET 7 FOR MATING PCB DETAILS.
3. CONNECTOR TOP MOUNTING ON PCB.
4. PAD DETAILS ON THE MATING PCB ALLOW CONTACT TO BE MADE IN ANY POSITION FROM THE STOP FACE UP TO 1mm FROM THE STOP FACE.
5. GENERAL TOLERANCE  $\pm 0.20$  UNLESS STATED.

ELCO EUROPE (A DIVISION OF AVX LTD.) CONFIDENTIAL PROPRIETY  
 THE DRAWING ON THIS PRINT AND INFORMATION THEREWITH ARE PROPRIETARY TO ELCO EUROPE (A DIVISION OF AVX LTD.) AND SHALL NOT BE USED OR DISCLOSED IN WHOLE OR IN PART WITHOUT ELCO EUROPE'S WRITTEN CONSENT.

SHEET 9 OF 10

Release No.	102809
History	10.11.2011
	06.01.2012
	12.01.2012
	03.02.2012
	08.02.2012
	28.03.2012
	102876
	26.04.2012
	102879
	14.05.2012
	26.06.2012
	24.07.2012

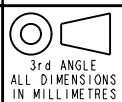

Drawn  
N.C.H.

Size  
CV

Description  
9159 THROUGH BOARD - ORDERING CODE

Part Number  
00-9159-01\_500S

DATE  
06-Jan-12

Issue  
6

A

B



**ACCESSORY - PROTECTING CAP**

Elco Europe (A Division of AVX Ltd) CONFIDENTIAL PROPRIETY  
 The document on this print and information therewith are PROPRIETY  
 to Elco Europe (A Division of AVX Ltd) and shall not be copied  
 or disclosed in whole or in part without Elco Europe's written consent.



2 WAY  
60-9159-3502-09-000

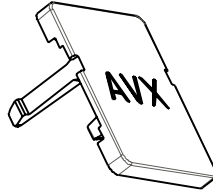
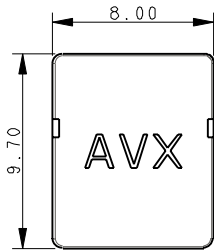

3 WAY  
60-9159-3503-09-000

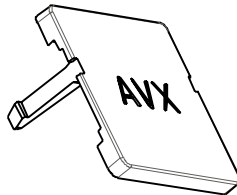
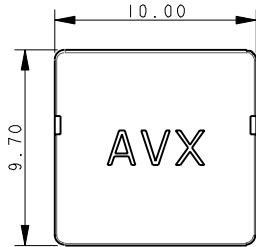

4 WAY  
60-9159-3504-09-000



5 WAY  
60-9159-350-09-000

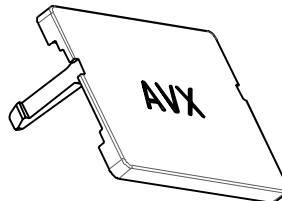

6 WAY  
60-9159-3506-09-000

- NOTES :-  
 1. PROTECTING CAP, ACCESSORY, NOT SUPPLIED WITH CONNECTOR.  
 2. CLIPS TO TOP OF CONNECTOR TO COVER ALL METAL COMPONENTS.  
 3. MATERIAL :- PA4T, GLASS FILLED, HALOGEN FREE, UL94 V-0,  
 COLOUR CODE REFER TO SHEET 1, "X" IN PART NUMBER.  
 4. SUPPLIED IN BAGS OF 1000 PIECES.  
 5. GENERAL TOLERANCE ±0.20.  
 12. UL REFERENCE E90723.



**ASSEMBLED CAP**

ELCO EUROPE (A DIVISION OF AVX LTD.) CONFIDENTIAL PROPRIETY  
 THE DRAWING ON THIS PRINT AND INFORMATION THEREWITH ARE  
 PROPRIETARY TO ELCO EUROPE (A DIVISION OF AVX LTD.) AND  
 SHALL NOT BE USED OR DISCLOSED IN WHOLE OR IN PART  
 WITHOUT ELCO EUROPE'S WRITTEN CONSENT.

SHEET 10 OF 10

Release No.	102809
History	10.11.2011
	06.01.2012
	12.01.2012
	03.02.2012
	08.02.2012
	08.03.2012
	28.03.2012
	102876
	26.04.2012
	102879
	14.03.2012
	15.03.2012
	26.06.2012
	24.07.2012

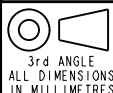

Drawn  
 N.C.H.

Size  
 CV

Description  
 9159 THROUGH BOARD - ORDERING CODE

Part Number  
 00-9159-01\_500S

DATE  
 06-Jan-12

Issue  
 6

A

B

Компания «Life Electronics» занимается поставками электронных компонентов импортного и отечественного производства от производителей и со складов крупных дистрибьюторов Европы, Америки и Азии.

С конца 2013 года компания активно расширяет линейку поставок компонентов по направлению коаксиальный кабель, кварцевые генераторы и конденсаторы (керамические, пленочные, электролитические), за счёт заключения дистрибьюторских договоров

Мы предлагаем:

- Конкурентоспособные цены и скидки постоянным клиентам.
- Специальные условия для постоянных клиентов.
- Подбор аналогов.
- Поставку компонентов в любых объемах, удовлетворяющих вашим потребностям.
- Приемлемые сроки поставки, возможна ускоренная поставка.
- Доставку товара в любую точку России и стран СНГ.
- Комплексную поставку.
- Работу по проектам и поставку образцов.
- Формирование склада под заказчика.
- Сертификаты соответствия на поставляемую продукцию (по желанию клиента).
- Тестирование поставляемой продукции.
- Поставку компонентов, требующих военную и космическую приемку.
- Входной контроль качества.
- Наличие сертификата ISO.

В составе нашей компании организован Конструкторский отдел, призванный помогать разработчикам, и инженерам.

Конструкторский отдел помогает осуществить:

- Регистрацию проекта у производителя компонентов.
- Техническую поддержку проекта.
- Защиту от снятия компонента с производства.
- Оценку стоимости проекта по компонентам.
- Изготовление тестовой платы монтаж и пусконаладочные работы.



Тел: +7 (812) 336 43 04 (многоканальный)  
Email: [org@lifeelectronics.ru](mailto:org@lifeelectronics.ru)