

RoHS SIDACtor® Balanced Multiport Series - MS-013



Agency Approvals

Agency	Agency File Number
	E133083

Pinout Designation

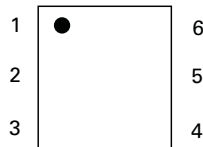

Schematic Diagram

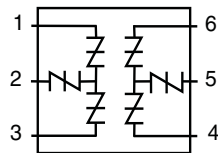

Description

SIDACtor® Balanced Multiport Series MS-013 are designed to protect baseband equipment from overvoltage transients. The patented “Y” configuration ensures balanced overvoltage protection.

The series provides a dual port surface mount solution that enables voice through DS-1 equipment to comply with various global regulatory standards.

Features and Benefits

- Low voltage overshoot
- Low on-state voltage
- Does not degrade with use
- Fails short circuit when surged in excess of ratings
- Low Capacitance
- Replaces six discrete devices
- Balanced overvoltage protection
- Meets UL/IEC 60950-1 creepage and clearance
- Two-port protection

Applicable Global Standards

- TIA-968-A
- TIA-968-B
- ITU K.20/21 Enhanced Level*
- ITU K.20/21 Basic Level
- GR 1089 Intra-building
- IEC 61000-4-5
- YD/T 1082
- YD/T 993
- YD/T 950

*A/B-rated parts require series resistance

Electrical Characteristics

Part Number	Marking	V_{DRM}	V_S	V_{DRM}	V_S	V_T	I_H	I_S	I_T	Capacitance
		@ $I_{DRM} = 5\mu A$	@ 100V/ μs	@ $I_{DRM} = 5\mu A$	@ 100V/ μs	@ $I_T = 2.2 A$	mA	mA	A	
		V min	V max	V min	V max	V max	min	max	max	
A2106UA6Lxx	A2106UA6	170	250	50	80	8	120	800	2.2	See Capacitance Values Table
A5030UA6Lxx	A5030UA6	400	550	270	340	8	150	800	2.2	
A2106UB6Lxx	A2106UB6	170	250	50	80	8	120	800	2.2	
A5030UB6Lxx	A5030UB6	400	550	270	340	8	150	800	2.2	
A2106UC6Lxx	A2106UC6	170	250	50	80	8	120	800	2.2	
A5030UC6Lxx	A5030UC6	400	550	270	340	8	150	800	2.2	
P1556UALxx	P1556UA	130	180	130	180	8	150	800	2.2	
P1806UALxx	P1806UA	150	210	150	210	8	150	800	2.2	
P2106UALxx	P2106UA	170	250	170	250	8	150	800	2.2	
P2356UALxx	P2356UA	200	270	200	270	8	150	800	2.2	
P2706UALxx	P2706UA	230	300	230	300	8	150	800	2.2	
P3206UALxx	P3206UA	270	350	270	350	8	150	800	2.2	
P3406UALxx	P3406UA	300	400	300	400	8	150	800	2.2	

Table continues on next page.

Electrical Characteristics (continued)

Part Number	Marking	V_{DRM}	V_S	V_{DRM}	V_S	V_T	I_H	I_S	I_T	Capacitance
		@ $I_{DRM} = 5\mu A$	@ 100V/ μs	@ $I_{DRM} = 5\mu A$	@ 100V/ μs	@ $I_T = 2.2 A$				
		V min	V max	V min	V max	V max	mA min	mA max	A max	
		Pins 1-2, 3-2, 4-5, 6-5		Pins 1-3, 4-6		Pins 1-2, 3-2, 4-5, 6-5				
P5106UALxx	P5106UA	420	600	420	600	8	150	800	2.2	See Capacitance Values Table
P1556UBLxx	P1556UB	130	180	130	180	8	150	800	2.2	
P1806UBLxx	P1806UB	150	210	150	210	8	150	800	2.2	
P2106UBLxx	P2106UB	170	250	170	250	8	150	800	2.2	
P2356UBLxx	P2356UB	200	270	200	270	8	150	800	2.2	
P2706UBLxx	P2706UB	230	300	230	300	8	150	800	2.2	
P3206UBLxx	P3206UB	270	350	270	350	8	150	800	2.2	
P3406UBLxx	P3406UB	300	400	300	400	8	150	800	2.2	
P5106UBLxx	P5106UB	420	600	420	600	8	150	800	2.2	
P1556UCLxx	P1556UC	130	180	130	180	8	150	800	2.2	
P1806UCLxx	P1806UC	150	210	150	210	8	150	800	2.2	
P2106UCLxx	P2106UC	170	250	170	250	8	150	800	2.2	
P2356UCLxx	P2356UC	200	270	200	270	8	150	800	2.2	
P2706UCLxx	P2706UC	230	300	230	300	8	150	800	2.2	
P3206UCLxx	P3206UC	270	350	270	350	8	150	800	2.2	
P3406UCLxx	P3406UC	300	400	300	400	8	150	800	2.2	
P5106UCLxx	P5106UC	420	600	420	600	8	150	800	2.2	

Notes:
 - Absolute maximum ratings measured at $T_A = 25^\circ C$ (unless otherwise noted).
 - Devices are bi-directional (some are asymmetrical).
 - XX = Part Number Suffix: 'TP' (Tube Pack) or 'RP' (Reel Pack).

Surge Ratings

Series	I_{PP}									I_{TSM} 50/60 Hz	di/dt
	0.2x310 ¹ 0.5x700 ²	2x10 ¹ 2x10 ²	8x20 ¹ 1.2x50 ²	10x160 ¹ 10x160 ²	10x560 ¹ 10x560 ²	5x320 ¹ 9x720 ²	10x360 ¹ 10x360 ²	10x1000 ¹ 10x1000 ²	5x310 ¹ 10x700 ²		
	A min	A min	A min	A min	A min	A min	A min	A min	A min		
A	20	150	150	90	50	75	75	45	75	20	500
B	25	250	250	150	100	100	125	80	100	25	500
C	50	500	400	200	150	200	175	100	200	30	500

Notes:
 1 Current waveform in μs
 2 Voltage waveform in μs
 - Peak pulse current rating (I_{pp}) is repetitive and guaranteed for the life of the product.
 - I_{pp} ratings applicable over temperature range of -40 to $+85^\circ C$
 - The device must initially be in thermal equilibrium with $-40^\circ C \leq T_J \leq +150^\circ C$

Thermal Considerations

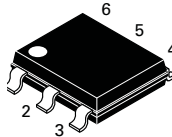
Package	Symbol	Parameter	Value	Unit
Modified MS-013 	T_J	Operating Junction Temperature Range	-40 to +150	$^\circ C$
	T_S	Storage Temperature Range	-65 to +150	$^\circ C$
	$R_{\theta JA}$	Thermal Resistance: Junction to Ambient	60	$^\circ C/W$

Capacitance Values

Part Number	pF Pin 1-2 / 3-2 (4-5 / 6-5) Tip-Ground, Ring-Ground		pF Pin 1-3 (4-6) Tip-Ring	
	MIN	MAX	MIN	MAX
	A2106UA6Lxx	20	60	10
A5030UA6Lxx	15	35	10	45
A2106UB6Lxx	20	60	10	30
A5030UB6Lxx	15	35	10	45
A2106UC6Lxx	20	70	10	45
A5030UC6Lxx	25	40	20	35
P1556UALxx	20	45	10	30
P1806UALxx	20	40	10	30
P2106UALxx	15	35	10	25
P2356UALxx	15	35	10	25
P2706UALxx	15	35	10	25
P3206UALxx	15	30	10	20
P3406UALxx	15	30	10	20
P5106UALxx	10	20	5	15
P1556UBLxx	20	45	10	30
P1806UBLxx	20	40	10	30
P2106UBLxx	15	35	10	25
P2356UBLxx	15	35	10	25
P2706UBLxx	15	35	10	25
P3206UBLxx	15	30	10	20
P3406UBLxx	15	30	10	20
P5106UBLxx	10	20	5	15
P1556UCLxx	30	55	20	35
P1806UCLxx	30	50	15	35
P2106UCLxx	30	45	15	30
P2356UCLxx	25	40	15	30
P2706UCLxx	25	40	15	30
P3206UCLxx	20	35	15	25
P3406UCLxx	20	35	15	25
P5106UCLxx	20	30	10	20

Note: Off-state capacitance (C_o) is measured at 1 MHz with a 2 V bias.

Physical Specifications

Lead Material	Copper Alloy
Terminal Finish	100% Matte-Tin Plated
Body Material	UL recognized epoxy meeting flammability classification 94V-0

Soldering Parameters

Reflow Condition	Pb-Free assembly (see Fig. 1)	
Pre Heat	- Temperature Min ($T_{s(min)}$)	+150°C
	- Temperature Max ($T_{s(max)}$)	+200°C
	- Time (Min to Max) (t_s)	60-180 secs.
Average ramp up rate (Liquidus Temp (T_L) to peak)	3°C/sec. Max.	
$T_{s(max)}$ to T_L - Ramp-up Rate	3°C/sec. Max.	
Reflow	- Temperature (T_L) (Liquidus)	+217°C
	- Temperature (t_L)	60-150 secs.
Peak Temp (T_p)	+260(+0/-5)°C	
Time within 5°C of actual PeakTemp (t_p)	30 secs. Max.	
Ramp-down Rate	6°C/sec. Max.	
Time 25°C to PeakTemp (T_p)	8 min. Max.	
Do not exceed	+260°C	

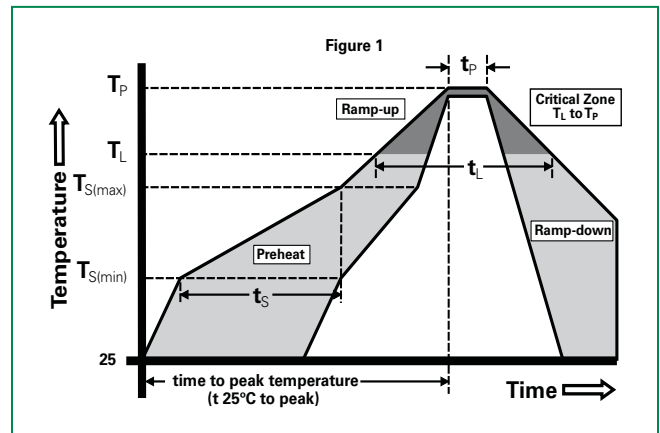

Environmental Specifications

High Temp Voltage Blocking	80% Rated V_{DRM} ($V_{AC Peak}$) +125°C or +150°C, 504 or 1008 hrs. MIL-STD-750 (Method 1040) JEDEC, JESD22-A-101
Temp Cycling	-65°C to +150°C, 15 min. dwell, 10 up to 100 cycles. MIL-STD-750 (Method 1051) EIA/JEDEC, JESD22-A104
Biased Temp & Humidity	52 V_{DC} (+85°C) 85% RH, 504 up to 1008 hrs. EIA/JEDEC, JESD22-A-101
High Temp Storage	+150°C 1008 hrs. MIL-STD-750 (Method 1031) JEDEC, JESD22-A-101
Low Temp Storage	-65°C, 1008 hrs.
Thermal Shock	0°C to +100°C, 5 min. dwell, 10 sec. transfer, 10 cycles. MIL-STD-750 (Method 1056) JEDEC, JESD22-A-106
Autoclave (Pressure Cooker Test)	+121°C, 100%RH, 2atm, 24 up to 168 hrs. EIA/JEDEC, JESD22-A-102
Resistance to Solder Heat	+260°C, 30 secs. MIL-STD-750 (Method 2031)
Moisture Sensitivity Level	85%RH, +85°C, 168 hrs., 3 reflow cycles (+260°C Peak). JEDEC-J-STD-020, Level 1

V-I Characteristics

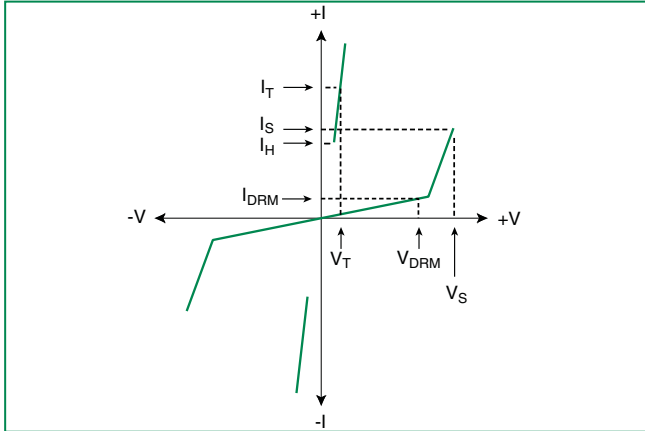

$t_r \times t_d$ Pulse Waveform

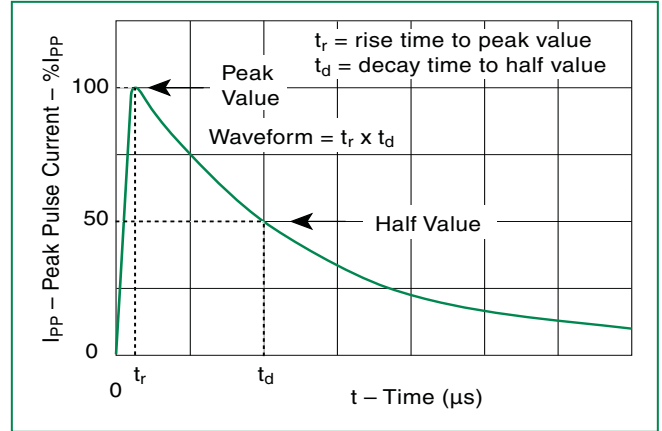

Normalized V_S Change vs. Junction Temperature

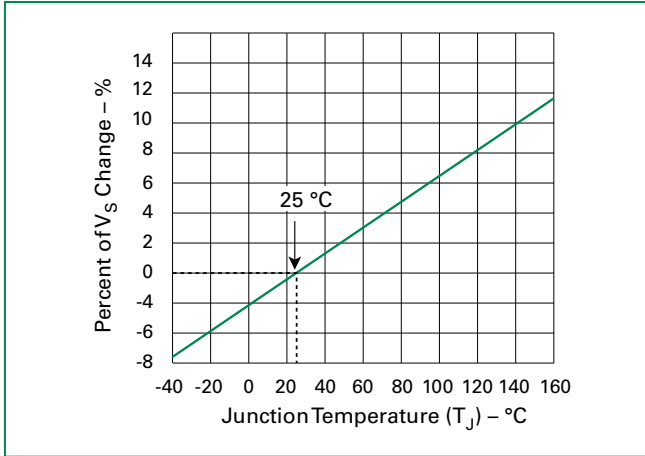

Normalized DC Holding Current vs. Case Temperature

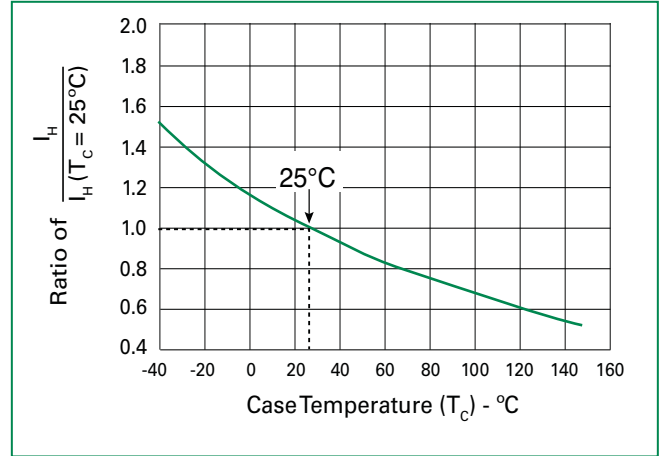

Part Numbering

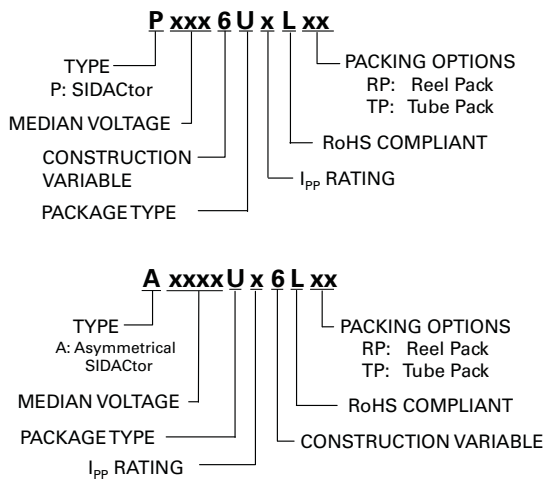

Part Marking

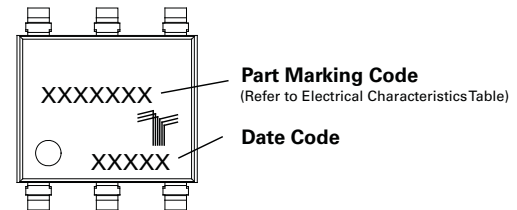

Dimensions — MS-013

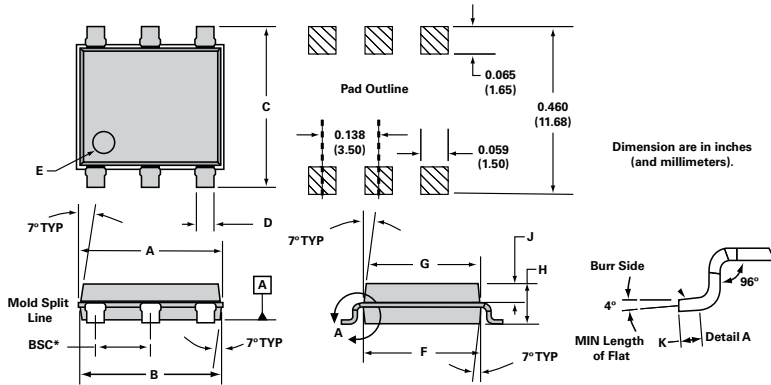

Dimensions	Inches		Millimeters	
	Min	Max	Min	Max
A	0.360	0.364	9.14	9.25
B	0.352	0.356	8.94	9.04
C	0.400	0.412	10.16	10.46
D	0.043	0.045	1.09	1.13
E	0.047	0.055	1.19	1.40
F	0.293	0.297	7.44	7.54
G	0.289	0.293	7.34	7.44
H	0.089	0.093	2.26	2.36
J	0.041	0.049	1.04	1.24
K	0.020		0.51	
BSC*	0.133	0.143	3.38	3.63

* BSC = Basic Spacing between Centers

Packing Options

Package Type	Description	Quantity	Added Suffix	Industry Standard
U	Modified MS-013 6-pin Tape and Reel Pack	1500	RP	EIA-481-D
	Modified MS-013 6-pin Tube Pack	500 (50 per tube)	TP	N/A

Tape and Reel Specification — MS-013

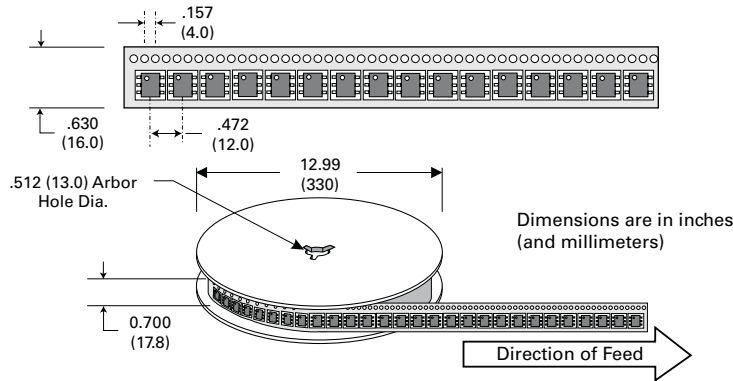

Tube Pack Specification — MS-013

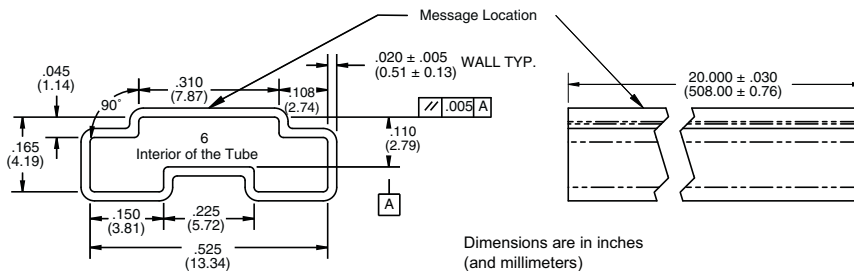

Компания «Life Electronics» занимается поставками электронных компонентов импортного и отечественного производства от производителей и со складов крупных дистрибьюторов Европы, Америки и Азии.

С конца 2013 года компания активно расширяет линейку поставок компонентов по направлению коаксиальный кабель, кварцевые генераторы и конденсаторы (керамические, пленочные, электролитические), за счёт заключения дистрибьюторских договоров

Мы предлагаем:

- Конкурентоспособные цены и скидки постоянным клиентам.
- Специальные условия для постоянных клиентов.
- Подбор аналогов.
- Поставку компонентов в любых объемах, удовлетворяющих вашим потребностям.
- Приемлемые сроки поставки, возможна ускоренная поставка.
- Доставку товара в любую точку России и стран СНГ.
- Комплексную поставку.
- Работу по проектам и поставку образцов.
- Формирование склада под заказчика.
- Сертификаты соответствия на поставляемую продукцию (по желанию клиента).
- Тестирование поставляемой продукции.
- Поставку компонентов, требующих военную и космическую приемку.
- Входной контроль качества.
- Наличие сертификата ISO.

В составе нашей компании организован Конструкторский отдел, призванный помогать разработчикам, и инженерам.

Конструкторский отдел помогает осуществить:

- Регистрацию проекта у производителя компонентов.
- Техническую поддержку проекта.
- Защиту от снятия компонента с производства.
- Оценку стоимости проекта по компонентам.
- Изготовление тестовой платы монтаж и пусконаладочные работы.



Тел: +7 (812) 336 43 04 (многоканальный)

Email: org@lifeelectronics.ru