

ESD-Protection Diode in LLP1006-2L

Features

- Ultra compact LLP1006-2L package
- Low package height < 0.4 mm
- 1-line ESD-protection
- Low leakage current < 0.01 μ A
- Low load capacitance $C_D = 12.5$ pF ($V_R = 6$ V; $f = 1$ MHz)
- ESD-protection acc. IEC 61000-4-2
 - ± 30 kV contact discharge
 - ± 30 kV air discharge
- High surge current acc. IEC61000-4-5 $I_{PP} > 4$ A
- Soldering can be checked by standard vision inspection. No X-ray necessary
- Lead (Pb)-free component
- Pin plating NiPdAu (e4) no whisker growth
- Component in accordance to RoHS 2002/95/EC and WEEE 2002/96/EC

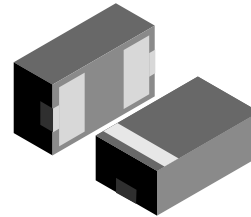

20855

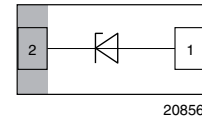

20856

Marking (example only)



Bar = Cathode marking
 X = Date code
 Y = Type code (see table below)

Ordering Information

Device name	Ordering code	Taped units per reel (8 mm tape on 7" reel)	Minimum order quantity
VESD12A1C-HD1	VESD12A1C-HD1-GS08	8000	8000

Package Data

Device name	Package name	Type code	Weight	Molding compound flammability rating	Moisture sensitivity level	Soldering conditions
VESD12A1C-HD1	LLP1006-2L	G	0.72 mg	UL 94 V-0	MSL level 1 (according J-STD-020)	260 °C/10 s at terminals

Absolute Maximum Ratings

Rating	Test conditions	Symbol	Value	Unit
Peak pulse current	Acc. IEC 61000-4-5, $t_p = 8/20$ μ s/single shot	I_{PPM}	4	A
Peak pulse power	Acc. IEC 61000-4-5, $t_p = 8/20$ μ s/single shot	P_{PP}	92	W
ESD immunity	Contact discharge acc. IEC 61000-4-2; 10 pulses	V_{ESD}	± 30	kV
	Air discharge acc. IEC 61000-4-2; 10 pulses	V_{ESD}	± 30	kV
Operating temperature	Junction temperature	T_J	- 40 to + 125	°C
Storage temperature		T_{STG}	- 55 to + 150	°C

* Please see document "Vishay Green and Halogen-Free Definitions (5-2008)" <http://www.vishay.com/doc?99902>

BiAs-Mode (Bidirectional Asymmetrical protection mode)

With the **VESD12A1C-HD1** one signal- or data-lines (L1) can be protected against voltage transients. With pin 1 connected to ground and pin 2 connected to a signal- or data-line which has to be protected. As long as the voltage level on the data- or signal-line is between 0 V (ground level) and the specified **Maximum Reverse Working Voltage** (V_{RWM}) the protection diode between data line and ground offers a high isolation to the ground line. The protection device behaves like an open switch.

As soon as any positive transient voltage signal exceeds the break through voltage level of the protection diode, the diode becomes conductive and shorts the transient current to ground. Now the protection device behaves like a closed switch. The **Clamping Voltage** (V_C) is defined by the **Breakthrough Voltage** (V_{BR}) level plus the voltage drop at the series impedance (resistance and inductance) of the protection device.

Any negative transient signal will be clamped accordingly. The negative transient current is flowing in the forward direction of the protection diode. The low **Forward Voltage** (V_F) clamps the negative transient close to the ground level.

Due to the different clamping levels in forward and reverse direction the **VESD12A1C-HD1** clamping behaviour is **Bidirectional** and **Asymmetrical (BiAs)**.

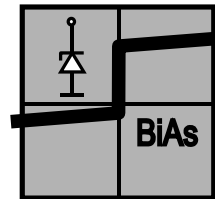
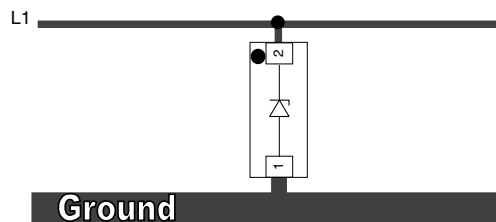

20925

Electrical Characteristics

Ratings at 25 °C, ambient temperature, unless otherwise specified

VESD12A1C-HD1

BiAs mode (between pin 1 and pin 2)

Parameter	Test conditions/remarks	Symbol	Min.	Typ.	Max.	Unit
Protection paths	Number of lines which can be protected	N_{lines}			1	lines
Reverse stand off voltage	at $I_R = 0.1 \mu A$	V_{RWM}	12			V
Reverse current	at $V_R = 12 V$	I_R		< 0.01	0.1	μA
Reverse break down voltage	at $I_R = 1 mA$	V_{BR}	13.5	14	16	V
Reverse clamping voltage	at $I_{PP} = 1 A$	V_C		15.8	17	V
	at $I_{PP} = I_{PPM} = 4 A$	V_C		20	23	V
Forward clamping voltage	at $I_{PP} = 0.2 A$	V_F		0.9	1.2	V
	at $I_{PP} = 1 A$	V_F		1.1	1.5	V
	at $I_{PP} = I_{PPM} = 4 A$	V_F		1.7	2.1	V
Capacitance	at $V_R = 0 V$; $f = 1 MHz$	C_D		30	36	pF
	at $V_R = 6 V$; $f = 1 MHz$	C_D		12.5		pF

Typical Characteristics

$T_{amb} = 25\text{ }^{\circ}\text{C}$, unless otherwise specified

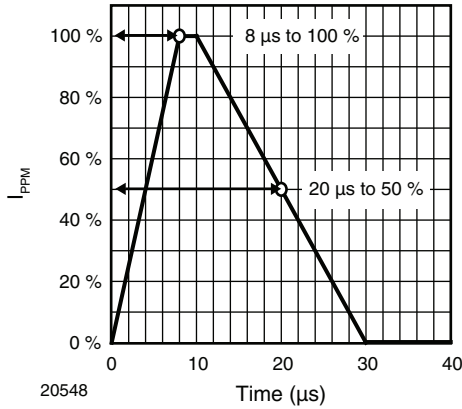

Figure 1. 8/20 μs Peak Pulse Current Wave Form (acc. IEC 61000-4-5)

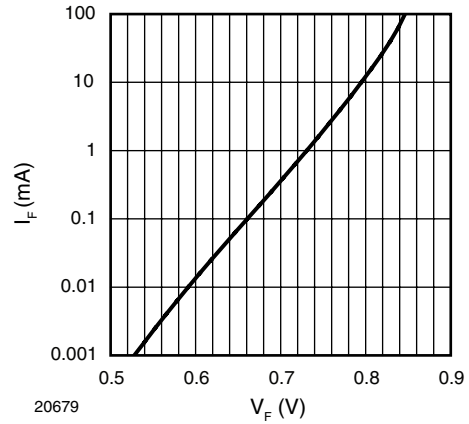

Figure 4. Typical Forward Current I_F vs. Forward Voltage V_F

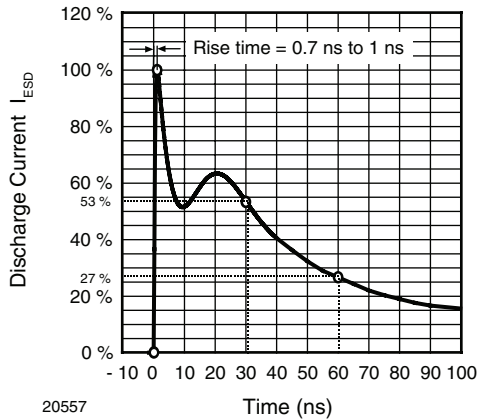

Figure 2. ESD Discharge Current Wave Form (acc. IEC 61000-4-2 (330 Ω /150 pF))

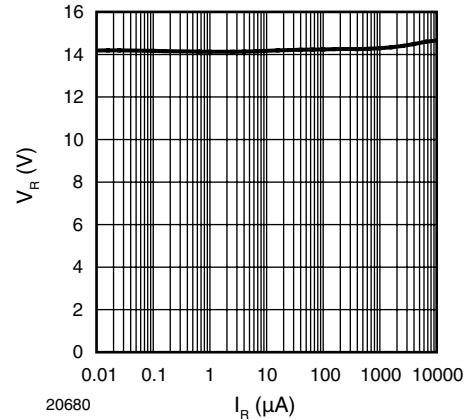

Figure 5. Typical Reverse Voltage V_R vs. Reverse Current I_R

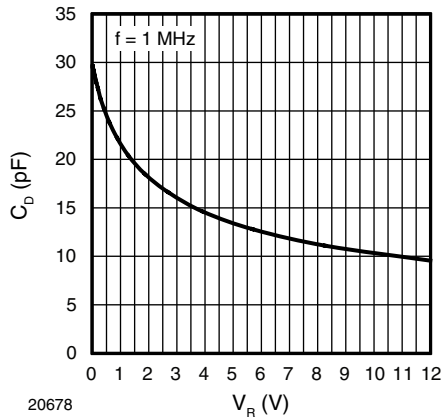

Figure 3. Typical Capacitance C_D vs. Reverse Voltage V_R

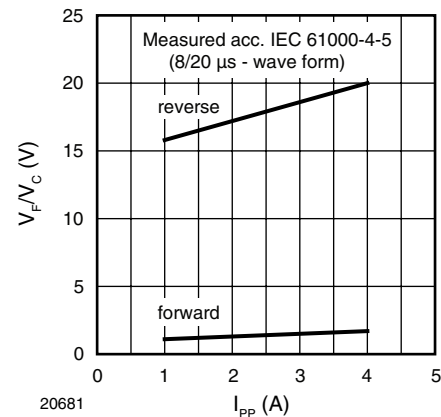

Figure 6. Typical Clamping Voltage vs. Peak Pulse Current I_{PP}

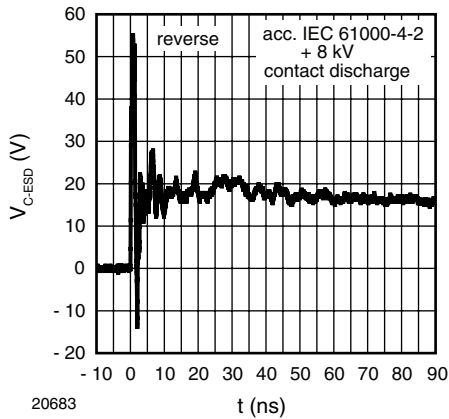

Figure 7. Typical Clamping Performance at + 8 kV Contact Discharge (acc. IEC 61000-4-2)

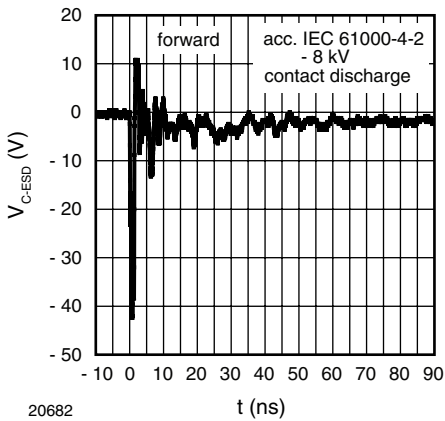

Figure 8. Typical Clamping Performance at - 8 kV Contact Discharge (acc. IEC 61000-4-2)

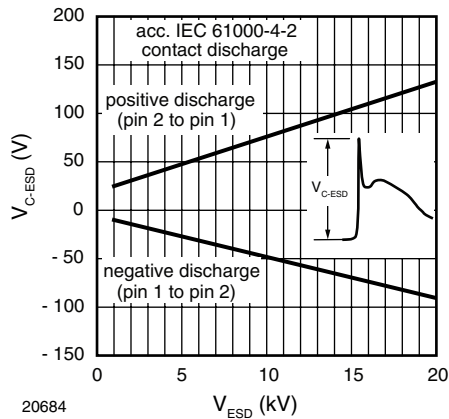
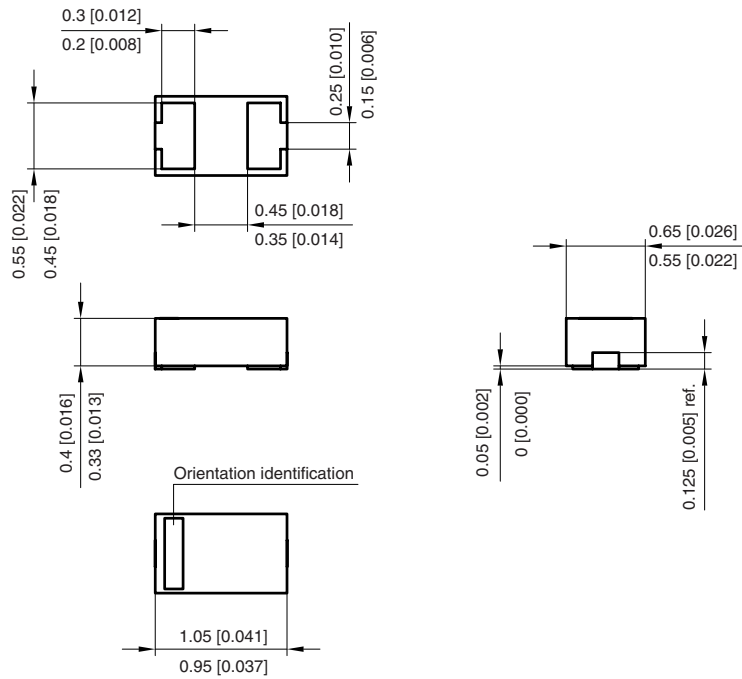

Figure 9. Typical Clamping Voltage at ± ESD Contact Discharge (acc. IEC 61000-4-2)



Package Dimensions in millimeters (inches): LLP1006-2L



foot print recommendation:

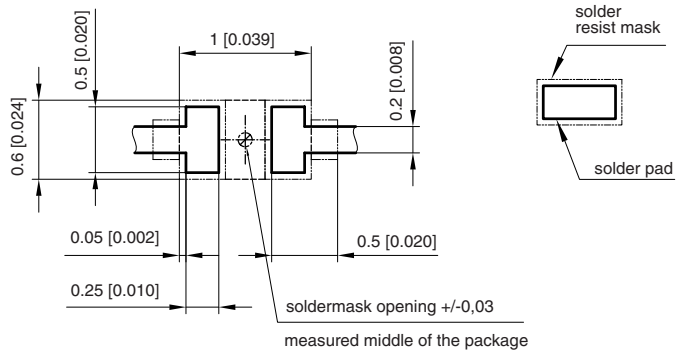

Document no.:S8-V-3906.04-005 (4)
Created - Date: 13.July.2007
Rev. 4 - Date: 28.Aug.2008
20812

Ozone Depleting Substances Policy Statement

It is the policy of Vishay Semiconductor GmbH to

1. Meet all present and future national and international statutory requirements.
2. Regularly and continuously improve the performance of our products, processes, distribution and operating systems with respect to their impact on the health and safety of our employees and the public, as well as their impact on the environment.

It is particular concern to control or eliminate releases of those substances into the atmosphere which are known as ozone depleting substances (ODSs).

The Montreal Protocol (1987) and its London Amendments (1990) intend to severely restrict the use of ODSs and forbid their use within the next ten years. Various national and international initiatives are pressing for an earlier ban on these substances.

Vishay Semiconductor GmbH has been able to use its policy of continuous improvements to eliminate the use of ODSs listed in the following documents.

1. Annex A, B and list of transitional substances of the Montreal Protocol and the London Amendments respectively.
2. Class I and II ozone depleting substances in the Clean Air Act Amendments of 1990 by the Environmental Protection Agency (EPA) in the USA.
3. Council Decision 88/540/EEC and 91/690/EEC Annex A, B and C (transitional substances) respectively.

Vishay Semiconductor GmbH can certify that our semiconductors are not manufactured with ozone depleting substances and do not contain such substances.

We reserve the right to make changes to improve technical design
and may do so without further notice.

Parameters can vary in different applications. All operating parameters must be validated for each customer application by the customer. Should the buyer use Vishay Semiconductors products for any unintended or unauthorized application, the buyer shall indemnify Vishay Semiconductors against all claims, costs, damages, and expenses, arising out of, directly or indirectly, any claim of personal damage, injury or death associated with such unintended or unauthorized use.

Vishay Semiconductor GmbH, P.O.B. 3535, D-74025 Heilbronn, Germany



Disclaimer

ALL PRODUCT, PRODUCT SPECIFICATIONS AND DATA ARE SUBJECT TO CHANGE WITHOUT NOTICE TO IMPROVE RELIABILITY, FUNCTION OR DESIGN OR OTHERWISE.

Vishay Intertechnology, Inc., its affiliates, agents, and employees, and all persons acting on its or their behalf (collectively, "Vishay"), disclaim any and all liability for any errors, inaccuracies or incompleteness contained in any datasheet or in any other disclosure relating to any product.

Vishay makes no warranty, representation or guarantee regarding the suitability of the products for any particular purpose or the continuing production of any product. To the maximum extent permitted by applicable law, Vishay disclaims (i) any and all liability arising out of the application or use of any product, (ii) any and all liability, including without limitation special, consequential or incidental damages, and (iii) any and all implied warranties, including warranties of fitness for particular purpose, non-infringement and merchantability.

Statements regarding the suitability of products for certain types of applications are based on Vishay's knowledge of typical requirements that are often placed on Vishay products in generic applications. Such statements are not binding statements about the suitability of products for a particular application. It is the customer's responsibility to validate that a particular product with the properties described in the product specification is suitable for use in a particular application. Parameters provided in datasheets and/or specifications may vary in different applications and performance may vary over time. All operating parameters, including typical parameters, must be validated for each customer application by the customer's technical experts. Product specifications do not expand or otherwise modify Vishay's terms and conditions of purchase, including but not limited to the warranty expressed therein.

Except as expressly indicated in writing, Vishay products are not designed for use in medical, life-saving, or life-sustaining applications or for any other application in which the failure of the Vishay product could result in personal injury or death. Customers using or selling Vishay products not expressly indicated for use in such applications do so at their own risk and agree to fully indemnify and hold Vishay and its distributors harmless from and against any and all claims, liabilities, expenses and damages arising or resulting in connection with such use or sale, including attorneys fees, even if such claim alleges that Vishay or its distributor was negligent regarding the design or manufacture of the part. Please contact authorized Vishay personnel to obtain written terms and conditions regarding products designed for such applications.

No license, express or implied, by estoppel or otherwise, to any intellectual property rights is granted by this document or by any conduct of Vishay. Product names and markings noted herein may be trademarks of their respective owners.

Компания «Life Electronics» занимается поставками электронных компонентов импортного и отечественного производства от производителей и со складов крупных дистрибьюторов Европы, Америки и Азии.

С конца 2013 года компания активно расширяет линейку поставок компонентов по направлению коаксиальный кабель, кварцевые генераторы и конденсаторы (керамические, пленочные, электролитические), за счёт заключения дистрибьюторских договоров

Мы предлагаем:

- Конкурентоспособные цены и скидки постоянным клиентам.
- Специальные условия для постоянных клиентов.
- Подбор аналогов.
- Поставку компонентов в любых объемах, удовлетворяющих вашим потребностям.
- Приемлемые сроки поставки, возможна ускоренная поставка.
- Доставку товара в любую точку России и стран СНГ.
- Комплексную поставку.
- Работу по проектам и поставку образцов.
- Формирование склада под заказчика.
- Сертификаты соответствия на поставляемую продукцию (по желанию клиента).
- Тестирование поставляемой продукции.
- Поставку компонентов, требующих военную и космическую приемку.
- Входной контроль качества.
- Наличие сертификата ISO.

В составе нашей компании организован Конструкторский отдел, призванный помогать разработчикам, и инженерам.

Конструкторский отдел помогает осуществить:

- Регистрацию проекта у производителя компонентов.
- Техническую поддержку проекта.
- Защиту от снятия компонента с производства.
- Оценку стоимости проекта по компонентам.
- Изготовление тестовой платы монтаж и пусконаладочные работы.



Тел: +7 (812) 336 43 04 (многоканальный)

Email: org@lifeelectronics.ru