

70V P-CHANNEL ENHANCEMENT MODE MOSFET
Product Summary

BV _{DSS}	R _{DS(on)} max	I _D T _A = +25°C
-70V	160mΩ @ V _{GS} = -10V	-5.7A
	250mΩ @ V _{GS} = -4.5V	-5.3A

Description

This new generation of trench MOSFETs utilizes a unique structure that combines the benefits of low on-resistance with fast switching speed. The ZXMP7A17KQ is ideal for high efficiency, low voltage power management applications.

Applications

- DC-DC Converters
- Power Management Functions
- Disconnect Switches
- Motor Control
- Class D Audio Output Stages

Features and Benefits

- Low On-Resistance
- Fast Switching Speed
- Low Threshold
- Low Gate Drive
- DPAK Package
- **Lead-Free Finish; RoHS Compliant (Notes 1 & 2)**
- **Halogen and Antimony Free. "Green" Device (Note 3)**
- **Qualified to AEC-Q101 Standards for High Reliability**
- **PPAP Capable (Note 4)**

Mechanical Data

- Case: TO252 (DPAK)
- Case Material: Molded Plastic, "Green" Molding Compound; UL Flammability Classification Rating 94V-0
- Moisture Sensitivity: Level 1 per J-STD-020
- Terminals Connections: See Diagram Below
- Terminals: Finish - Matte Tin Annealed over Copper Leadframe; Solderable per MIL-STD-202, Method 208③
- Weight: 0.315 grams (Approximate)

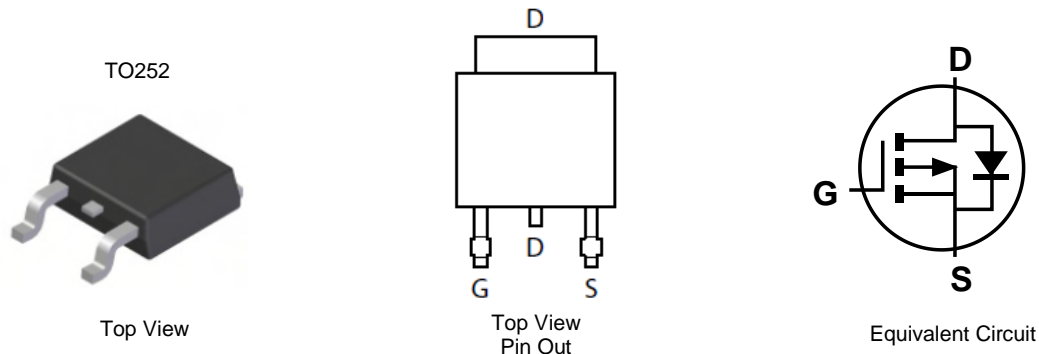
Ordering Information (Note 5)

Part Number	Case	Packaging
ZXMP7A17KQTC	TO252	2,500/Tape & Reel

- Notes:
1. EU Directive 2002/95/EC (RoHS) & 2011/65/EU (RoHS 2) compliant. All applicable RoHS exemptions applied.
 2. See http://www.diodes.com/quality/lead_free.html for more information about Diodes Incorporated's definitions of Halogen- and Antimony-free, "Green" and Lead-free.
 3. Halogen- and Antimony-free "Green" products are defined as those which contain <900ppm bromine, <900ppm chlorine (<1500ppm total Br + Cl) and <1000ppm antimony compounds.
 4. Automotive products are AEC-Q101 qualified and are PPAP capable. Automotive, AEC-Q101 and standard products are electrically and thermally the same, except where specified. For more information, please refer to http://www.diodes.com/quality/product_grade_definitions/.
 5. For packaging details, go to our website at <http://www.diodes.com/products/packages.html>.

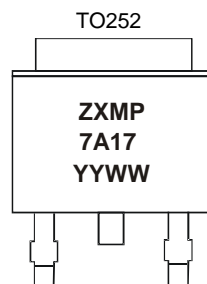
Marking Information

ZXMP7A17 = Product Type Marking Code
 YYWW = Date Code Marking
 YY = Year (ex: 10 = 2010)
 WW = Week (01 - 53)

Maximum Ratings (@T_A = +25°C, unless otherwise specified.)

Characteristic			Symbol	Value	Unit	
Drain-Source Voltage			V _{DSS}	-70	V	
Gate-Source Voltage			V _{GS}	±20	V	
Continuous Drain Current	V _{GS} = 10V	(Note 7)	I _D	-5.7	A	
		T _A = +70°C (Note 7)		-4.6		
		(Note 6)		-3.8		
Pulsed Drain Current	V _{GS} = 10V	(Note 8)	I _{DM}	-17.7	A	
Continuous Source Current (Body diode)			(Note 7)	I _S	-9.2	A
Pulsed Source Current (Body diode)			(Note 8)	I _{SM}	-17.7	A

Thermal Characteristics (@T_A = +25°C, unless otherwise specified.)

Characteristic		Symbol	Value	Unit
Power Dissipation Linear Derating Factor	(Note 6)	P _D	4.17	W mW/°C
			33.3	
	(Note 7)		9.25	
			74	
	(Note 9)		2.11	
			16.8	
Thermal Resistance, Junction to Ambient	(Note 6)	R _{θJA}	30	°C/W
	(Note 7)		13.5	
	(Note 8)		59.1	
Operating and Storage Temperature Range		T _J , T _{STG}	-55 to +150	°C

Electrical Characteristics (@T_A = +25°C, unless otherwise specified.)

Characteristic	Symbol	Min	Typ	Max	Unit	Test Condition
OFF CHARACTERISTICS						
Drain-Source Breakdown Voltage	BV _{DSS}	-70	—	—	V	I _D = -250μA, V _{GS} = 0V
Zero Gate Voltage Drain Current	I _{DSS}	—	—	-1	μA	V _{DS} = -70V, V _{GS} = 0V
Gate-Source Leakage	I _{GSS}	—	—	±100	nA	V _{GS} = ±20V, V _{DS} = 0V
ON CHARACTERISTICS						
Gate Threshold Voltage	V _{GS(th)}	-1.0	—	—	V	I _D = -250μA, V _{DS} = V _{GS}
Static Drain-Source On-Resistance (Note 10)	R _{DS(ON)}	—	—	0.16	Ω	V _{GS} = -10V, I _D = -2.1A
				0.25		V _{GS} = -4.5V, I _D = -1.7A
Forward Transconductance (Notes 10 & 11)	g _{fs}	—	4.4	—	S	V _{DS} = -15V, I _D = -2.1A
Diode Forward Voltage (Note 10)	V _{SD}	—	-0.85	-0.95	V	I _S = -2.0A, V _{GS} = 0V, T _J = +25°C
Reverse Recovery Time (Note 11)	t _{rr}	—	29.8	—	ns	I _S = -2.1A, di/dt = 100A/μs
Reverse Recovery Charge (Note 11)	Q _{rr}	—	38.5	—	nC	
DYNAMIC CHARACTERISTICS (Note 11)						
Input Capacitance	C _{iss}	—	635	—	pF	V _{DS} = -40V, V _{GS} = 0V f = 1MHz
Output Capacitance	C _{oss}	—	52	—	pF	
Reverse Transfer Capacitance	C _{rss}	—	42.5	—	pF	
Total Gate Charge (Note 12)	Q _g	—	9.6	—	nC	V _{GS} = -5V
Total Gate Charge (Note 12)	Q _g	—	18	—	nC	V _{GS} = -10V V _{DS} = -35V I _D = -2.1A
Gate-Source Charge (Note 12)	Q _{gs}	—	1.77	—	nC	
Gate-Drain Charge (Note 12)	Q _{gd}	—	3.66	—	nC	
Turn-On Delay Time (Note 12)	t _{D(on)}	—	2.5	—	ns	V _{DD} = -35V, V _{GS} = -10V I _D = -1A, R _G ≅ 6.0Ω
Turn-On Rise Time (Note 12)	t _r	—	3.4	—	ns	
Turn-Off Delay Time (Note 12)	t _{D(off)}	—	27.9	—	ns	
Turn-Off Fall Time (Note 12)	t _f	—	8	—	ns	

- Notes:
6. For a device surface mounted on 50mm x 50mm x 1.6mm FR4 PCB with high coverage of single sided 2oz copper, in still air conditions.
 7. For a device surface mounted on FR4 PCB measured at t ≤ 10 sec.
 8. Repetitive rating 50mm x 50mm x 1.6mm FR4 PCB, D=0.02 pulse width=300μs - pulse width limited by maximum junction temperature.
 9. For a device surface mounted on 25mm x 25mm x 1.6mm FR4 PCB with high coverage of single sided 1oz copper, in still air conditions.
 10. Measured under pulsed conditions. Pulse width ≤ 300μs; duty cycle ≤ 2%.
 11. Switching characteristics are independent of operating junction temperature.
 12. For design aid only, not subject to production testing.

Thermal Characteristics

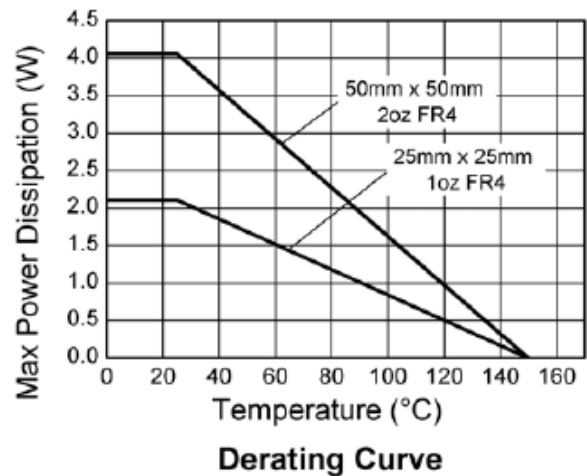
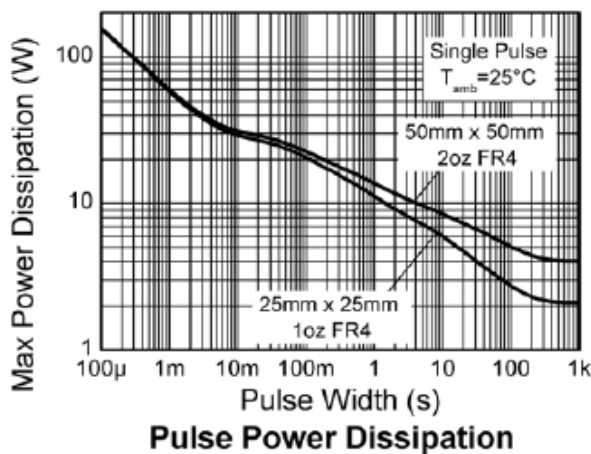
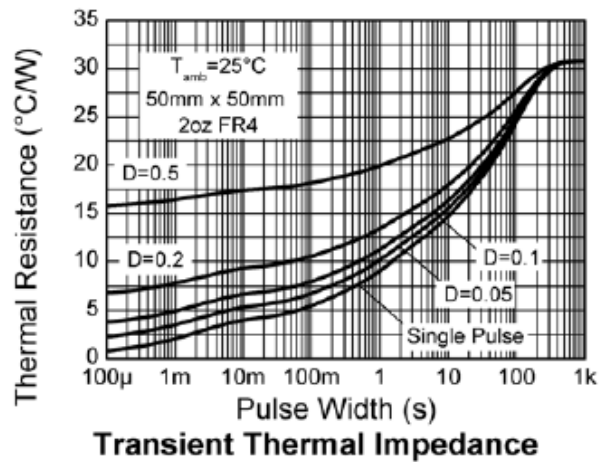
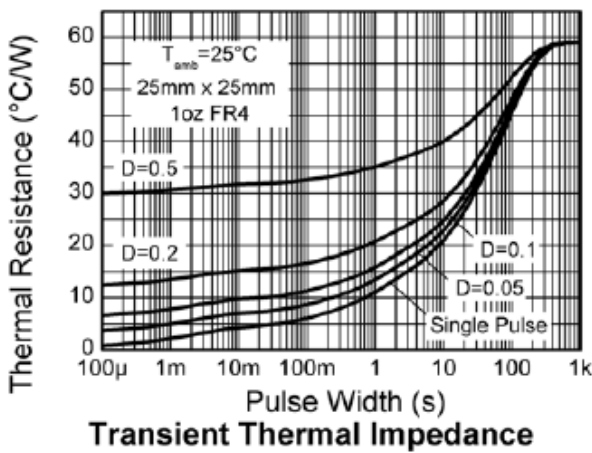
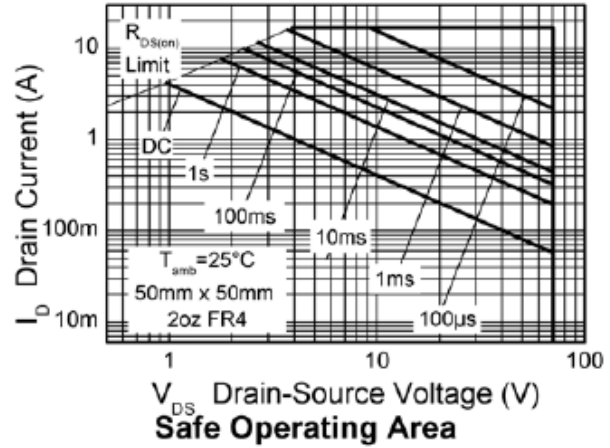
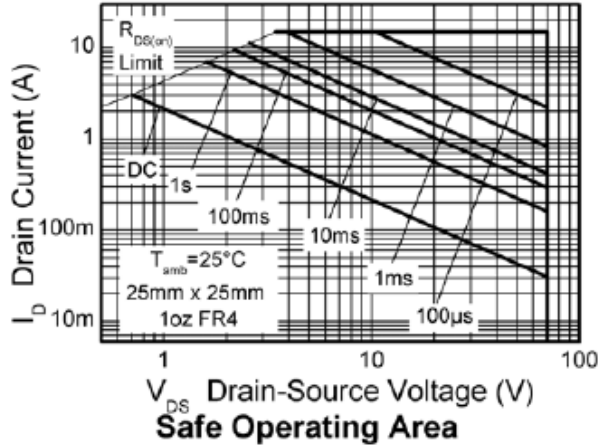

Typical Characteristics

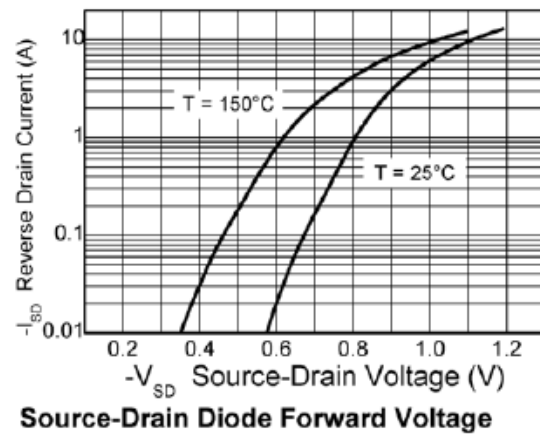
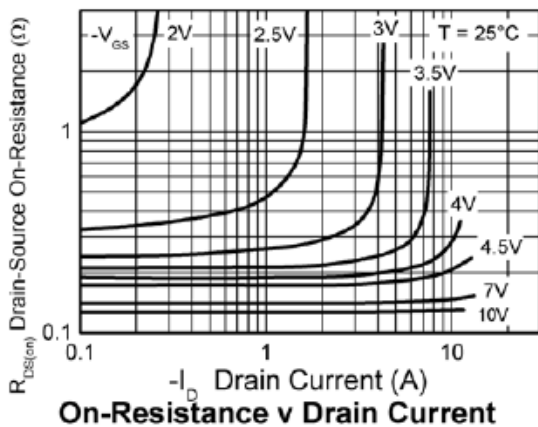
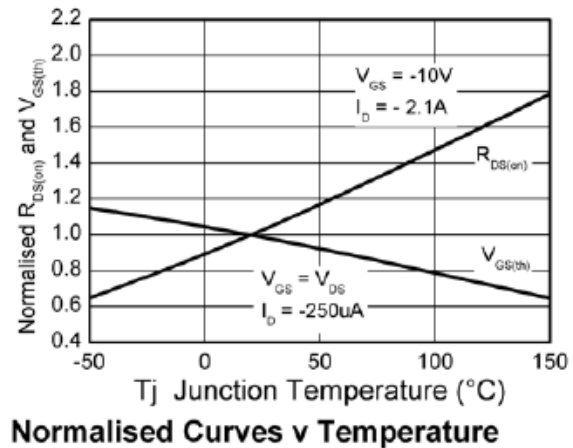
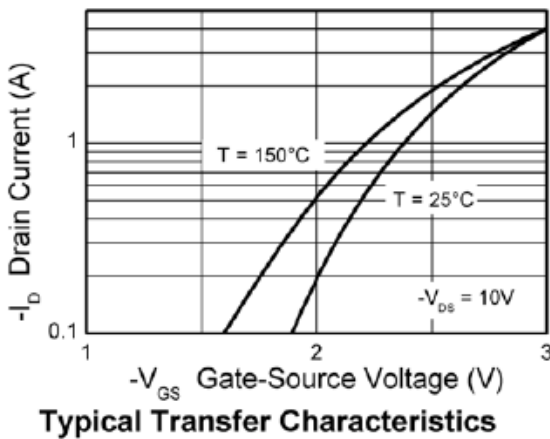
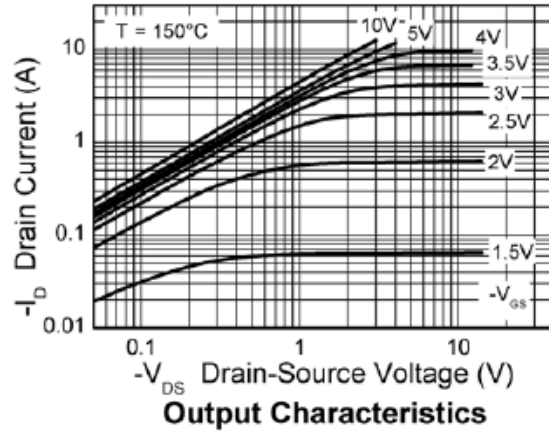
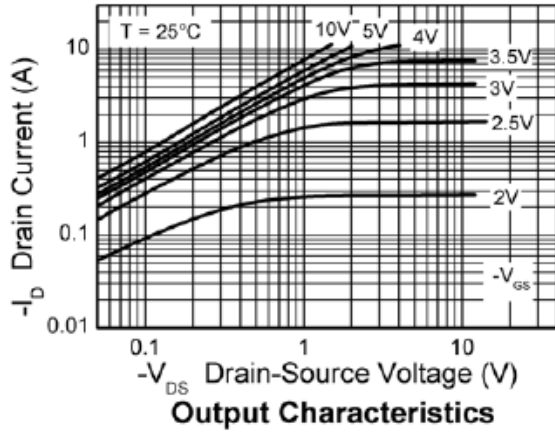

Typical Characteristics (cont.)

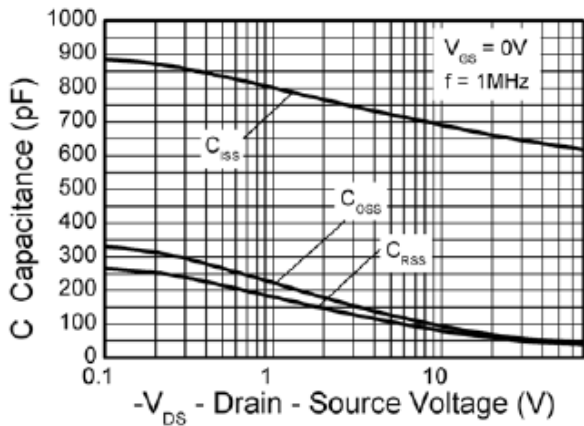

Capacitance v Drain-Source Voltage

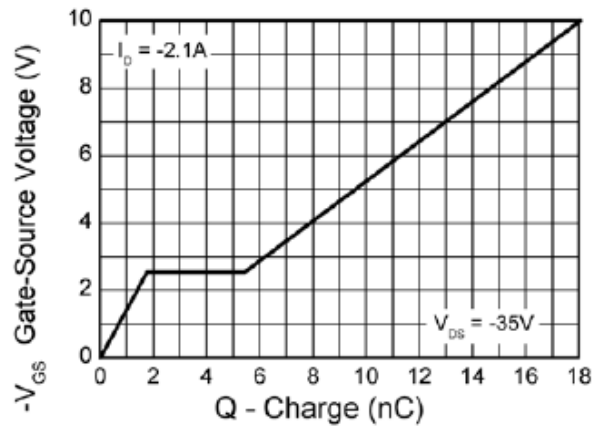

Gate-Source Voltage v Gate Charge

Package Outline Dimensions

Please see AP02002 at <http://www.diodes.com/datasheets/ap02002.pdf> for the latest version.

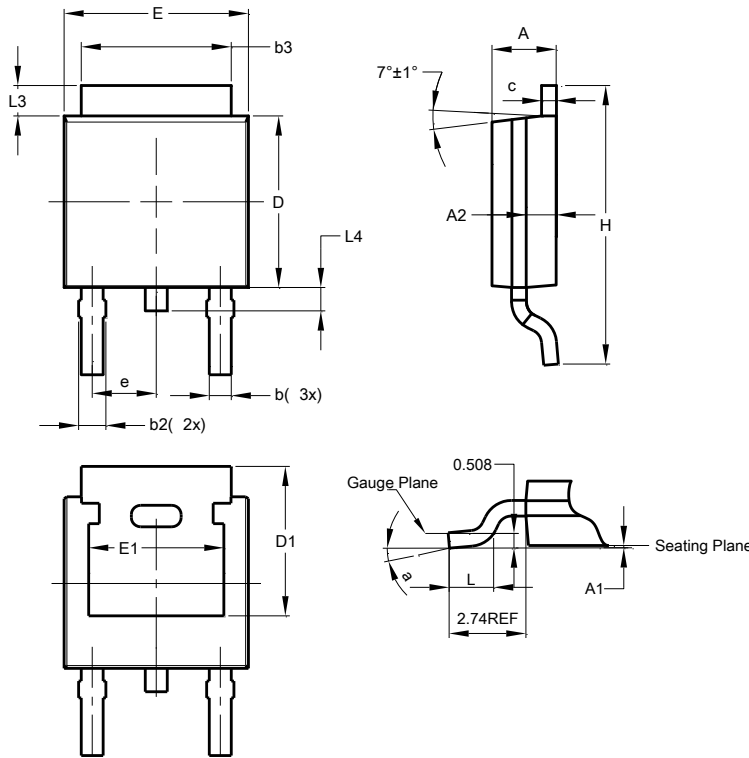

TO252 (DPAK)			
Dim	Min	Max	Typ
A	2.19	2.39	2.29
A1	0.00	0.13	0.08
A2	0.97	1.17	1.07
b	0.64	0.88	0.783
b2	0.76	1.14	0.95
b3	5.21	5.46	5.33
c	0.45	0.58	0.531
D	6.00	6.20	6.10
D1	5.21	-	-
e	-	-	2.286
E	6.45	6.70	6.58
E1	4.32	-	-
H	9.40	10.41	9.91
L	1.40	1.78	1.59
L3	0.88	1.27	1.08
L4	0.64	1.02	0.83
a	0°	10°	-
All Dimensions in mm			

Suggested Pad Layout

Please see AP02001 at <http://www.diodes.com/datasheets/ap02001.pdf> for the latest version.

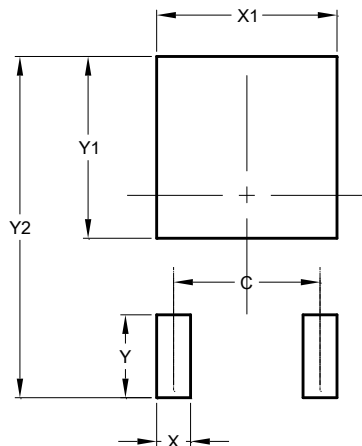

Dimensions	Value (in mm)
C	4.572
X	1.060
X1	5.632
Y	2.600
Y1	5.700
Y2	10.700

IMPORTANT NOTICE

DIODES INCORPORATED MAKES NO WARRANTY OF ANY KIND, EXPRESS OR IMPLIED, WITH REGARDS TO THIS DOCUMENT, INCLUDING, BUT NOT LIMITED TO, THE IMPLIED WARRANTIES OF MERCHANTABILITY AND FITNESS FOR A PARTICULAR PURPOSE (AND THEIR EQUIVALENTS UNDER THE LAWS OF ANY JURISDICTION).

Diodes Incorporated and its subsidiaries reserve the right to make modifications, enhancements, improvements, corrections or other changes without further notice to this document and any product described herein. Diodes Incorporated does not assume any liability arising out of the application or use of this document or any product described herein; neither does Diodes Incorporated convey any license under its patent or trademark rights, nor the rights of others. Any Customer or user of this document or products described herein in such applications shall assume all risks of such use and will agree to hold Diodes Incorporated and all the companies whose products are represented on Diodes Incorporated website, harmless against all damages.

Diodes Incorporated does not warrant or accept any liability whatsoever in respect of any products purchased through unauthorized sales channel. Should Customers purchase or use Diodes Incorporated products for any unintended or unauthorized application, Customers shall indemnify and hold Diodes Incorporated and its representatives harmless against all claims, damages, expenses, and attorney fees arising out of, directly or indirectly, any claim of personal injury or death associated with such unintended or unauthorized application.

Products described herein may be covered by one or more United States, international or foreign patents pending. Product names and markings noted herein may also be covered by one or more United States, international or foreign trademarks.

This document is written in English but may be translated into multiple languages for reference. Only the English version of this document is the final and determinative format released by Diodes Incorporated.

LIFE SUPPORT

Diodes Incorporated products are specifically not authorized for use as critical components in life support devices or systems without the express written approval of the Chief Executive Officer of Diodes Incorporated. As used herein:

A. Life support devices or systems are devices or systems which:

1. are intended to implant into the body, or
2. support or sustain life and whose failure to perform when properly used in accordance with instructions for use provided in the labeling can be reasonably expected to result in significant injury to the user.

B. A critical component is any component in a life support device or system whose failure to perform can be reasonably expected to cause the failure of the life support device or to affect its safety or effectiveness.

Customers represent that they have all necessary expertise in the safety and regulatory ramifications of their life support devices or systems, and acknowledge and agree that they are solely responsible for all legal, regulatory and safety-related requirements concerning their products and any use of Diodes Incorporated products in such safety-critical, life support devices or systems, notwithstanding any devices- or systems-related information or support that may be provided by Diodes Incorporated. Further, Customers must fully indemnify Diodes Incorporated and its representatives against any damages arising out of the use of Diodes Incorporated products in such safety-critical, life support devices or systems.

Copyright © 2015, Diodes Incorporated

www.diodes.com

Компания «Life Electronics» занимается поставками электронных компонентов импортного и отечественного производства от производителей и со складов крупных дистрибьюторов Европы, Америки и Азии.

С конца 2013 года компания активно расширяет линейку поставок компонентов по направлению коаксиальный кабель, кварцевые генераторы и конденсаторы (керамические, пленочные, электролитические), за счёт заключения дистрибьюторских договоров

Мы предлагаем:

- Конкуренеспособные цены и скидки постоянным клиентам.
- Специальные условия для постоянных клиентов.
- Подбор аналогов.
- Поставку компонентов в любых объемах, удовлетворяющих вашим потребностям.
- Приемлемые сроки поставки, возможна ускоренная поставка.
- Доставку товара в любую точку России и стран СНГ.
- Комплексную поставку.
- Работу по проектам и поставку образцов.
- Формирование склада под заказчика.
- Сертификаты соответствия на поставляемую продукцию (по желанию клиента).
- Тестирование поставляемой продукции.
- Поставку компонентов, требующих военную и космическую приемку.
- Входной контроль качества.
- Наличие сертификата ISO.

В составе нашей компании организован Конструкторский отдел, призванный помогать разработчикам, и инженерам.

Конструкторский отдел помогает осуществить:

- Регистрацию проекта у производителя компонентов.
- Техническую поддержку проекта.
- Защиту от снятия компонента с производства.
- Оценку стоимости проекта по компонентам.
- Изготовление тестовой платы монтаж и пусконаладочные работы.



Тел: +7 (812) 336 43 04 (многоканальный)

Email: org@lifeelectronics.ru