

Analog Devices Welcomes Hittite Microwave Corporation

NO CONTENT ON THE ATTACHED DOCUMENT HAS CHANGED



THIS PAGE INTENTIONALLY LEFT BLANK

Typical Applications

The HMC545A / HMC545AE is ideal for:

- Cellular/3G Infrastructure
- Private Mobile Radio Handsets
- WLAN, WiMAX & WiBro
- Automotive Telematics
- Test Equipment

Functional Diagram

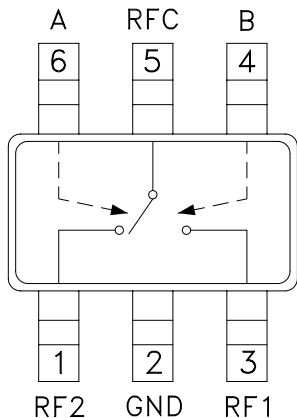

Features

- Low Insertion Loss: 0.27 dB
- High Input IP3: +54 dBm
- Low DC Power Consumption
- Positive Control: 0/+3V to 0/+8V
- Ultra Small Package: SOT26

General Description

The HMC545A and HMC545AE are low-cost SPDT switches in 6-lead SOT26 plastic packages for use in general switching applications which require very low insertion loss and very small size. With 0.25 dB typical loss, these devices can control signals from DC to 3.0 GHz and are especially suited for IF and RF applications including Cellular/3G, ISM, automotive and portables. The design provides exceptional insertion loss performance, ideal for filter and receiver switching. RF1 and RF2 are reflective shorts when "Off". The two control voltages require a minimal amount of DC current and offer compatibility with CMOS and some TTL logic families.

Electrical Specifications

$T_A = +25^\circ \text{C}$, $V_{ctl} = 0/+5 \text{Vdc}$ (Unless Otherwise Stated), 50 Ohm System

| Parameter | Frequency | Min. | Typ. | Max. | Units |
|---|---------------|--|------|------|-------|
| Insertion Loss | DC - 1.0 GHz | | 0.27 | 0.4 | dB |
| | DC - 2.5 GHz | | 0.3 | 0.5 | dB |
| | DC - 3.0 GHz | | 0.4 | 0.7 | dB |
| Isolation | DC - 2.0 GHz | 26 | 31 | | dB |
| | DC - 2.5 GHz | 22 | 26 | | dB |
| | DC - 3.0 GHz | 19 | 22 | | dB |
| Return Loss | DC - 1.0 GHz | | 24 | | dB |
| | DC - 2.0 GHz | | 20 | | dB |
| | DC - 2.5 GHz | | 19 | | dB |
| | DC - 3.0 GHz | | 17 | | dB |
| Input Power for 1 dB Compression | 0.5 - 3.0 GHz | $V_{ctl} = 0/+3V$ | 20 | 23 | dBm |
| | | $V_{ctl} = 0/+5V$ | 27 | 30 | dBm |
| | | $V_{ctl} = 0/+8V$ | 30 | 33 | dBm |
| Input Third Order Intercept (Two-tone Input Power = +17 dBm Each Tone) | 0.5 - 3.0 GHz | $V_{ctl} = 0/+3V$ | | 31 | dBm |
| | | $V_{ctl} = 0/+5V$ | | 51 | dBm |
| | | $V_{ctl} = 0/+8V$ | | 54 | dBm |
| Switching Characteristics | DC - 3.0 GHz | t_{RISE}, t_{FALL} (10/90% RF) | | 70 | ns |
| | | t_{ON}, t_{OFF} (50% CTL to 10/90% RF) | | 90 | ns |



Insertion Loss

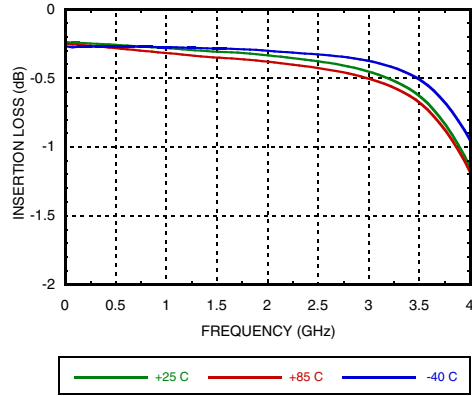

Return Loss

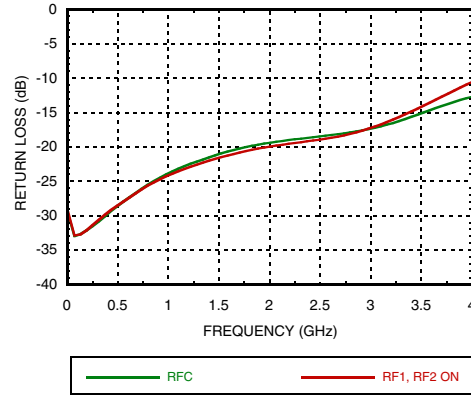

Isolation Between Ports RFC and RF1/RF2

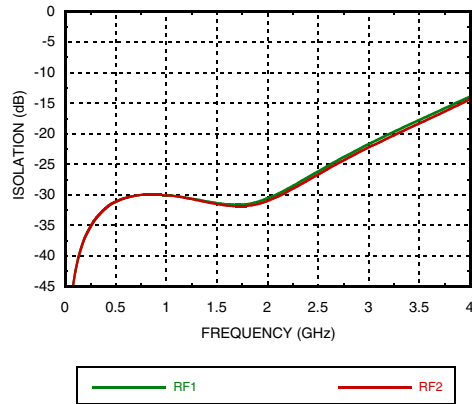

Isolation Between Ports RF1 and RF2

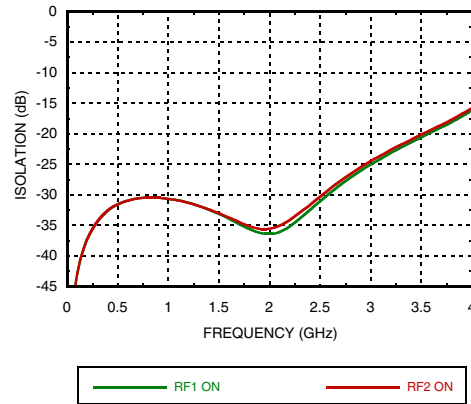

Input P0.1dB vs. Vctl

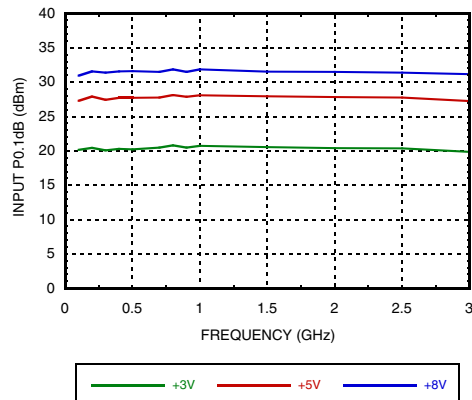

Input P1dB vs. Vctl

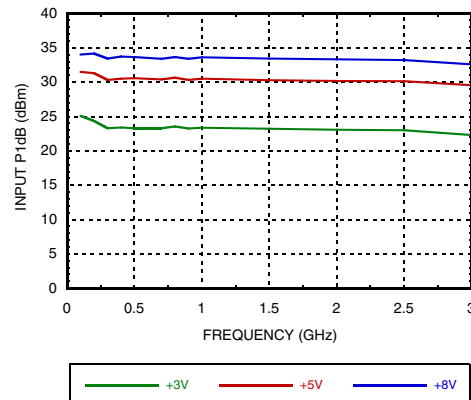



Low Frequency Input P0.1dB vs. Vctl

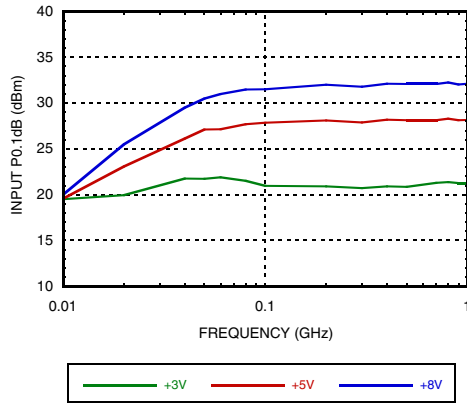

Low Frequency Input P1dB vs. Vctl

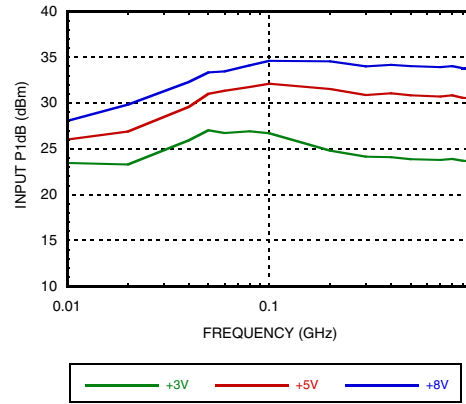

Input Third Order Intercept Point vs. Control Voltage

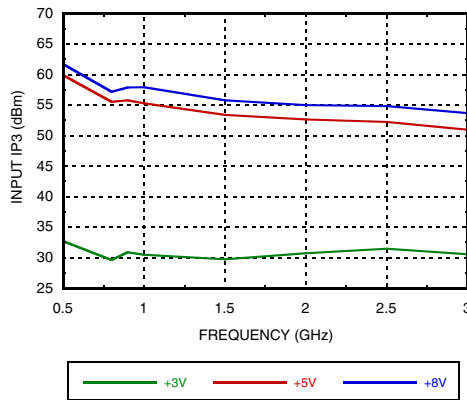

Absolute Maximum Ratings

| | |
|---|-----------------|
| RF Input Power (Vctl = 0/+8V) | +34 dBm |
| Control Voltage Range (A & B) | -0.2 to +12 Vdc |
| Hot Switch Power Level (Vctl = 0/+8V) | +32 dBm |
| Channel Temperature | 150 °C |
| Continuous P _{diss} (T = 85 °C) (derate 5.6 mW/ °C above 85°C) | 0.1 W |
| Thermal Resistance | 169°C/W |
| Storage Temperature | -65 to +150 °C |
| Operating Temperature | -40 to +85 °C |
| ESD Sensitivity (HBM) | Class 1A |

DC blocks are required at ports RFC, RF1 and RF2.



**ELECTROSTATIC SENSITIVE DEVICE
OBSERVE HANDLING PRECAUTIONS**

Insertion Loss, T = +25 °C

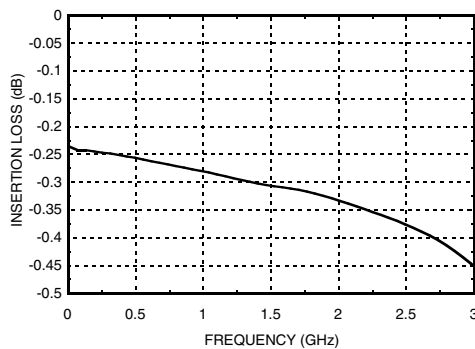

Truth Table

| Control Input | | Control Current | |
|---------------|------|-----------------|------------|
| A | B | RFC to RF1 | RFC to RF2 |
| Low | High | Off | On |
| High | Low | On | Off |

Control Voltages

| State | Bias Condition |
|-------|--|
| Low | 0 to 0.2 Vdc @ 1 µA Typical |
| High | +3 Vdc @ 0.5 µA Typical to +8 Vdc @ 14 µA Typical (±0.2 Vdc) |

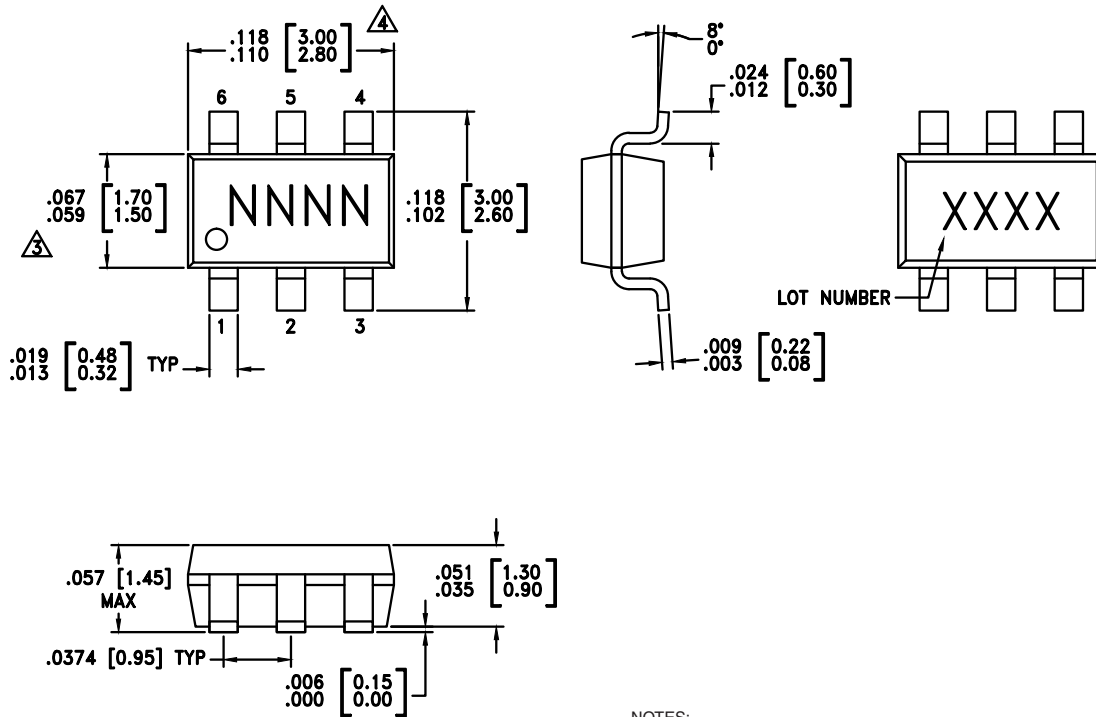
Outline Drawing

NOTES:

1. LEADFRAME MATERIAL: COPPER ALLOY
2. DIMENSIONS ARE IN INCHES [MILLIMETERS].
3. DIMENSION DOES NOT INCLUDE MOLDFLASH OF 0.15mm PER SIDE.
4. DIMENSION DOES NOT INCLUDE MOLDFLASH OF 0.25mm PER SIDE.
5. ALL GROUND LEADS MUST BE SOLDERED TO PCB RF GROUND.

Package Information

| Part Number | Package Body Material | Lead Finish | MSL Rating | Package Marking |
|-------------|--|---------------|---------------------|-----------------|
| HMC545A | Low Stress Injection Molded Plastic | Sn/Pb Solder | MSL1 ^[1] | H545A |
| HMC545AE | RoHS-compliant Low Stress Injection Molded Plastic | 100% matte Sn | MSL1 ^[2] | 545AE |

[1] Max peak reflow temperature of 235 °C

[2] Max peak reflow temperature of 260 °C

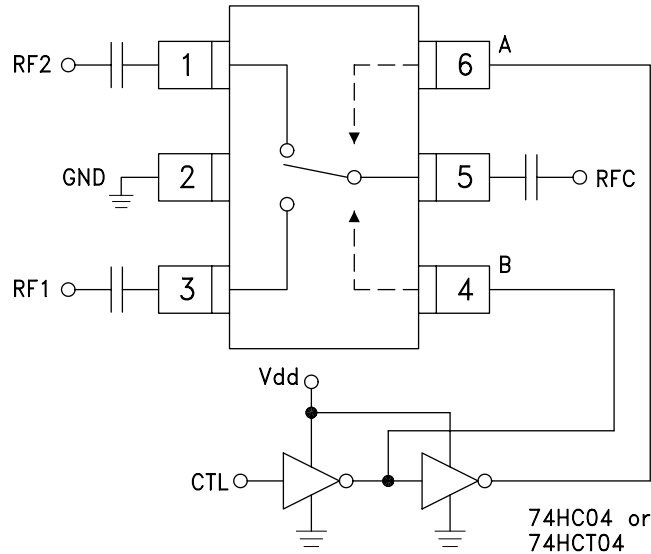
Typical Application Circuit

Notes:

1. Set logic gate Vdd = +3V to +5V and use HCT series logic to provide a TTL driver interface.
2. Control inputs A/B can be driven directly with CMOS logic (HC) with Vdd of +3V to +8V applied to the CMOS logic gates.
3. DC Blocking capacitors are required for each RF port as shown. Capacitor value determines lowest frequency of operation.
4. Highest RF signal power capability is achieved with Vdd = +8V and A/B set to 0/+8V.

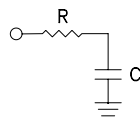
Pin Descriptions

| Pin Number | Function | Description | Interface Schematic |
|------------|---------------|---|---|
| 1, 3, 5 | RF2, RF1, RFC | These pins are DC coupled and matched to 50 Ohms. Blocking capacitors are required. | |
| 2 | GND | This pin must be connected to RF/DC ground. |  |
| 4 | B | See truth and control voltage tables. |  |
| 6 | A | See truth and control voltage tables. | |

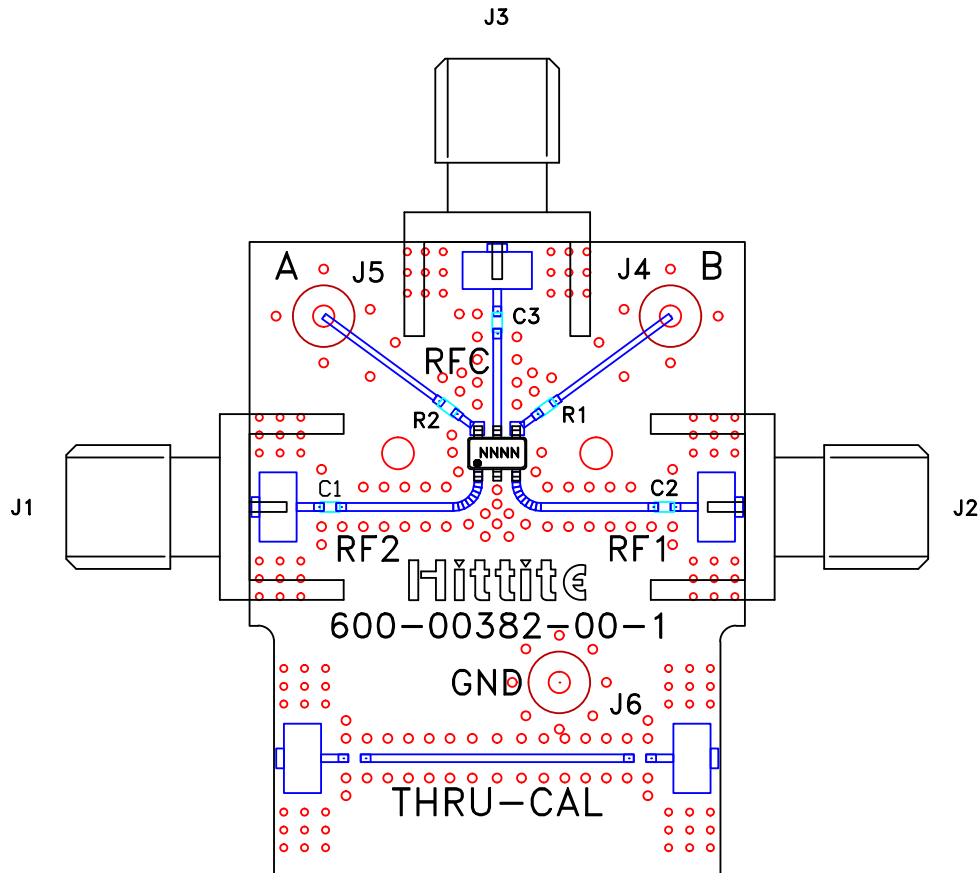
Evaluation PCB



List of Materials for Evaluation PCB EV1HMC545A [1]

| Item | Description |
|---------|--------------------------------|
| J1 - J3 | PCB Mount SMA RF Connector |
| J4 - J6 | DC Pin |
| R1 - R2 | 1K Ohm resistor, 0402 Pkg. |
| C1 - C3 | 330 pF capacitor, 0402 Pkg. |
| U1 | HMC545A / HMC545AE SPDT Switch |
| PCB [2] | 101659 Evaluation PCB |

[1] Reference this number when ordering complete evaluation PCB

[2] Circuit Board Material: Rogers 4350

The circuit board used in the application should be generated with proper RF circuit design techniques. Signal lines at the RF port should have 50 Ohm impedance and the package ground leads should be connected directly to the ground plane similar to that shown above. The evaluation circuit board shown above is available from Hittite Microwave Corporation upon request.

Компания «Life Electronics» занимается поставками электронных компонентов импортного и отечественного производства от производителей и со складов крупных дистрибьюторов Европы, Америки и Азии.

С конца 2013 года компания активно расширяет линейку поставок компонентов по направлению коаксиальный кабель, кварцевые генераторы и конденсаторы (керамические, пленочные, электролитические), за счёт заключения дистрибьюторских договоров

Мы предлагаем:

- Конкурентоспособные цены и скидки постоянным клиентам.
- Специальные условия для постоянных клиентов.
- Подбор аналогов.
- Поставку компонентов в любых объемах, удовлетворяющих вашим потребностям.
- Приемлемые сроки поставки, возможна ускоренная поставка.
- Доставку товара в любую точку России и стран СНГ.
- Комплексную поставку.
- Работу по проектам и поставку образцов.
- Формирование склада под заказчика.
- Сертификаты соответствия на поставляемую продукцию (по желанию клиента).
- Тестирование поставляемой продукции.
- Поставку компонентов, требующих военную и космическую приемку.
- Входной контроль качества.
- Наличие сертификата ISO.

В составе нашей компании организован Конструкторский отдел, призванный помогать разработчикам, и инженерам.

Конструкторский отдел помогает осуществить:

- Регистрацию проекта у производителя компонентов.
- Техническую поддержку проекта.
- Защиту от снятия компонента с производства.
- Оценку стоимости проекта по компонентам.
- Изготовление тестовой платы монтаж и пусконаладочные работы.



Тел: +7 (812) 336 43 04 (многоканальный)

Email: org@lifeelectronics.ru