



General Description

The AZV358 is dual low voltage (2.7-5.5V) operational amplifiers which have rail-to-rail output swing capability. The input common-mode voltage range includes ground. The chip exhibits excellent speed-power ratio, achieving 1MHz of bandwidth and 1V/ μ s of slew rate with low supply current.

The AZV358 is built with BiCMOS process. It has bipolar input and output stages for improved noise performance, low input offset voltage and higher output current drive.

AZV358 is available in the package of TSSOP-8 and MSOP-8. The small packages save space on pc boards, and enable the design of small portable electronic devices. It also allows the designer to place the device closer to the signal source to reduce noise pickup and increase signal integrity.

AZV358 is also available in standard SOIC-8 package.

Features

(For $V_{CC}=5V$ and $V_{EE}=0V$, typical unless otherwise noted)

- Guaranteed 2.7V to 5.5V Performance
- No Crossover Distortion
- Gain-Bandwidth Product 1MHz
- Industrial Temperature Range: $-40^{\circ}C$ to $+85^{\circ}C$
- Low Supply Current: 210 μ A
- Rail-to-Rail Output Swing under 10k Ω Load:
 - V_{OH} up to $V_{CC} - 10mV$
 - V_{OL} near to $V_{EE} + 65mV$
- V_{CM} : $-0.1V$ to $V_{CC} - 0.8V$

Applications

- Active Filters
- Low Power, Low Voltage Applications
- General Purpose Portable Devices
- Cellular Phone, Cordless Phone
- Battery-Powered Systems

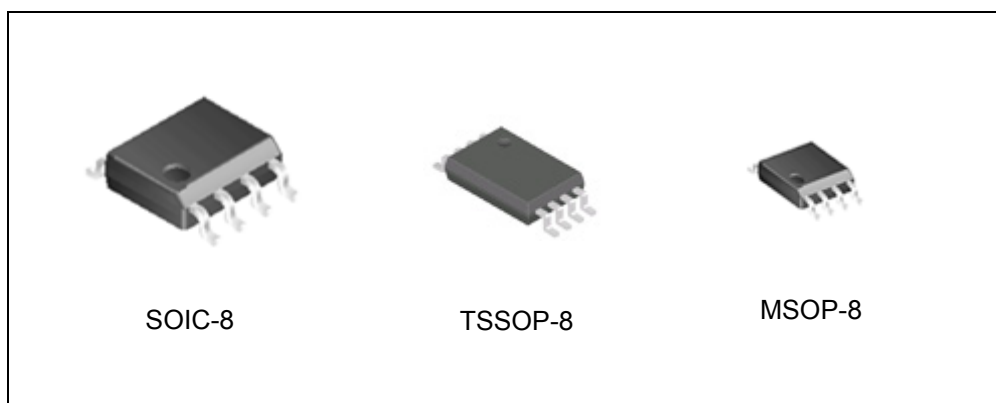

Figure 1. Package Types of AZV358

Pin Configuration

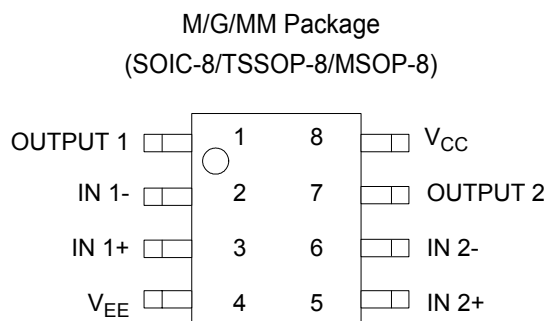

Figure 2. Pin Configuration of AZV358 (Top View)

Functional Block Diagram

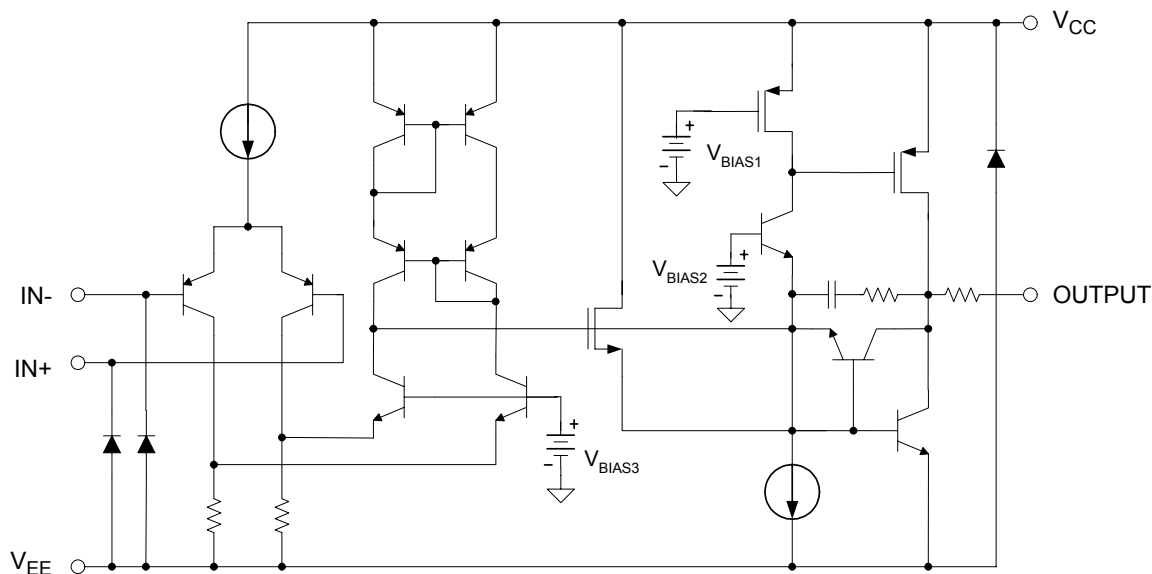

Figure 3. Functional Block Diagram of AZV358 (Each Block)



DUAL LOW VOLTAGE RAIL-TO-RAIL OUTPUT OPERATIONAL AMPLIFIERS

AZV358

Ordering Information

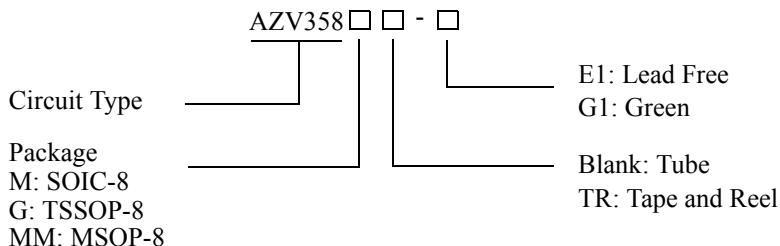

| Package | Temperature Range | Part Number | | Marking ID | | Packing Type |
|---------|-------------------|---------------|---------------|-------------|-------------|--------------|
| | | Lead Free | Green | Lead Free | Green | |
| SOIC-8 | -40 to 85°C | AZV358M-E1 | AZV358M-G1 | AZV358M-E1 | AZV358M-G1 | Tube |
| | | AZV358MTR-E1 | AZV358MTR-G1 | AZV358M-E1 | AZV358M-G1 | Tape & Reel |
| TSSOP-8 | -40 to 85°C | AZV358G-E1 | AZV358G-G1 | EG3E | GG3E | Tube |
| | | AZV358GTR-E1 | AZV358GTR-G1 | EG3E | GG3E | Tape & Reel |
| MSOP-8 | -40 to 85°C | AZV358MM-E1 | AZV358MM-G1 | AZV358MM-E1 | AZV358MM-G1 | Tube |
| | | AZV358MMTR-E1 | AZV358MMTR-G1 | AZV358MM-E1 | AZV358MM-G1 | Tape & Reel |

BCD Semiconductor's Pb-free products, as designated with "E1" suffix in the part number, are RoHS compliant. Products with "G1" suffix are available in green packages.

Absolute Maximum Ratings (Note 1)

| Parameter | Symbol | Value | Unit |
|--|-------------------|------------|------|
| Power Supply Voltage | V _{CC} | 6 | V |
| Operation Junction Temperature | T _J | 150 | °C |
| Storage Temperature Range | T _{STG} | -65 to 150 | °C |
| Lead Temperature (Soldering, 10 Seconds) | T _{LEAD} | 260 | °C |
| ESD (Machine Model) | | 200 | V |
| ESD (Human Body Model) | | 2000 | V |

Note 1: Stresses greater than those listed under "Absolute Maximum Ratings" may cause permanent damage to the device. These are stress ratings only, and functional operation of the device at these or any other conditions beyond those indicated under "Recommended Operating Conditions" is not implied. Exposure to "Absolute Maximum Ratings" for extended periods may affect device reliability.

Recommended Operating Conditions

| Parameter | Symbol | Min | Max | Unit |
|-------------------------------------|-----------------|-----|-----|------|
| Supply Voltage | V _{CC} | 2.7 | 5.5 | V |
| Ambient Operating Temperature Range | T _A | -40 | 85 | °C |



DUAL LOW VOLTAGE RAIL-TO-RAIL OUTPUT OPERATIONAL AMPLIFIERS AZV358

2.7V Electrical Characteristics

Limits in standard typeface are for $T_A=25^{\circ}\text{C}$, **bold** typeface applies over $T_A=-40^{\circ}\text{C}$ to 85°C , $V_{CC}=2.7\text{V}$, $V_{EE}=0\text{V}$, $V_{CM}=1.0\text{V}$, $V_O=V_{CC}/2$ and $R_L>1\text{M}\Omega$, unless otherwise specified. (Note 2)

| Parameter | Symbol | Conditions | Min | Typ | Max | Unit |
|---------------------------------|--------------|--|------|------|------------|---------------|
| Input Offset Voltage | V_{IO} | | | 1.7 | 7 | mV |
| | | | | | 9 | |
| Input Bias Current | I_B | | | 11 | 250 | nA |
| | | | | | 500 | |
| Input Offset Current | I_{IO} | | | 5 | 50 | nA |
| | | | | | 150 | |
| Input Common Mode Voltage Range | V_{CM} | for $\text{CMRR}\geq 50\text{dB}$ | -0.1 | | 1.9 | V |
| Supply Current | I_{CC} | $V_O=V_{CC}/2$, $A_{VCL}=1$, No load | | 140 | 340 | μA |
| | | | | | 420 | |
| Common Mode Rejection Ratio | CMRR | $0\leq V_{CM}\leq 1.7\text{V}$ | 50 | 63 | | dB |
| Power Supply Rejection Ratio | PSRR | $2.7\text{V}\leq V_{CC}\leq 5\text{V}$ $V_O=1\text{V}$, | 50 | 60 | | dB |
| Output Short Circuit Current | I_{SOURCE} | $V_O=0\text{V}$ | 5 | 20 | | mA |
| | I_{SINK} | $V_O=2.7\text{V}$ | 10 | 30 | | mA |
| Output Voltage Swing | V_{OH} | $R_L=10\text{k}\Omega$ to 1.35V | 2.60 | 2.69 | | V |
| | V_{OL} | | | 60 | 180 | mV |
| Gain Bandwidth Product | GBWP | $C_L=200\text{pF}$ | | 1 | | MHz |
| Phase Margin | ϕ_M | | | 60 | | deg |
| Gain Margin | G_M | | | 10 | | dB |

Note 2: Limits over the full temperature are guaranteed by design, but not tested in production.



DUAL LOW VOLTAGE RAIL-TO-RAIL OUTPUT OPERATIONAL AMPLIFIERS AZV358

5V Electrical Characteristics

Limits in standard typeface are for $T_A=25^{\circ}\text{C}$, **bold** typeface applies over $T_A=-40^{\circ}\text{C}$ to 85°C , $V_{CC}=5\text{V}$, $V_{EE}=0\text{V}$, $V_{CM}=2.0\text{V}$, $V_O=V_{CC}/2$ and $R_L>1\text{M}\Omega$, unless otherwise specified. (Note 2)

| Parameter | Symbol | Conditions | Min | Typ | Max | Unit |
|---------------------------------|--------------|---|------------|------------|------------------|---------------|
| Input Offset Voltage | V_{IO} | | | 1.7 | 7 | mV |
| | | | | | 9 | |
| Input Bias Current | I_B | | | 15 | 250 | nA |
| | | | | | 500 | |
| Input Offset Current | I_{IO} | | | 5 | 50 | nA |
| | | | | | 150 | |
| Input Common Mode Voltage Range | V_{CM} | for $\text{CMRR}\geq 50\text{dB}$ | -0.1 | | 4.2 | V |
| Supply Current | I_{CC} | $V_O=V_{CC}/2$, $A_{VCL}=1$, No load | | 210 | 440 | μA |
| | | | | | 615 | |
| Large Signal Voltage Gain | G_V | $R_L=2\text{k}\Omega$ | 84 | 100 | | dB |
| | | | 80 | | | |
| Common Mode Rejection Ratio | CMRR | $0\leq V_{CM}\leq 4\text{V}$ | 50 | 63 | | dB |
| Power Supply Rejection Ratio | PSRR | $2.7\text{V}\leq V_{CC}\leq 5\text{V}$ $V_O=1\text{V}$, $V_{CM}=1\text{V}$ | 50 | 60 | | dB |
| Output Short Circuit Current | I_{SOURCE} | $V_O=0\text{V}$ | 5 | 60 | | mA |
| | I_{SINK} | $V_O=5\text{V}$ | 10 | 160 | | mA |
| Output Voltage Swing | V_{OH} | $R_L=2\text{k}\Omega$ to 2.5V | 4.7 | 4.96 | | V |
| | | | 4.6 | | | |
| | | $R_L=10\text{k}\Omega$ to 2.5V | 4.9 | 4.99 | | |
| | | | 4.8 | | | |
| | V_{OL} | $R_L=2\text{k}\Omega$ to 2.5V | | 120 | 300 | mV |
| | | | | | 400 | |
| $R_L=10\text{k}\Omega$ to 2.5V | | | 65 | 180 | | |
| | | | | 280 | | |
| Slew Rate | SR | | 1 | | V/ μs | |
| Gain Bandwidth Product | GBWP | $C_L=200\text{pF}$ | | 1 | | MHz |
| Phase Margin | ϕ_M | | | 60 | | deg |
| Gain Margin | G_M | | | 10 | | dB |

Note 2: Limits over the full temperature are guaranteed by design, but not tested in production.



Typical Performance Characteristics

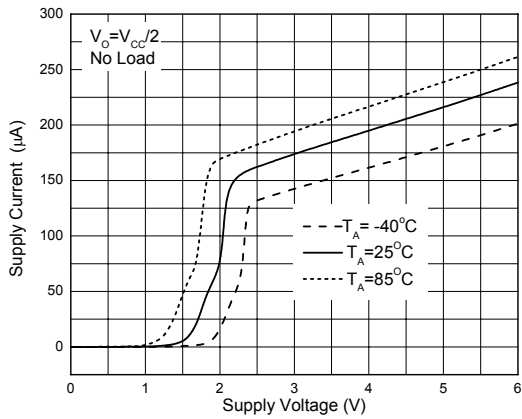

Figure 4. Supply Current vs. Supply Voltage

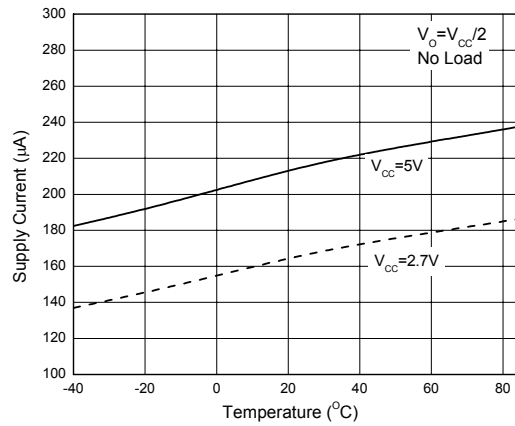

Figure 5. Supply Current vs. Temperature

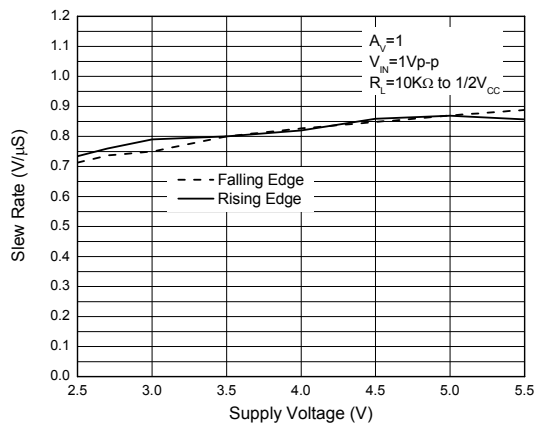

Figure 6. Slew Rate vs. Supply Voltage

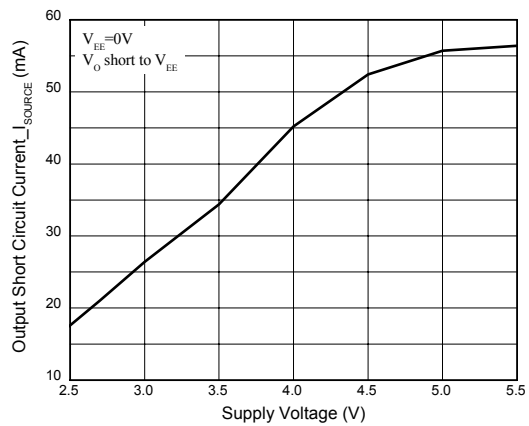

Figure 7. Output Short Circuit Current vs. Supply Voltage



Typical Performance Characteristics (Continued)

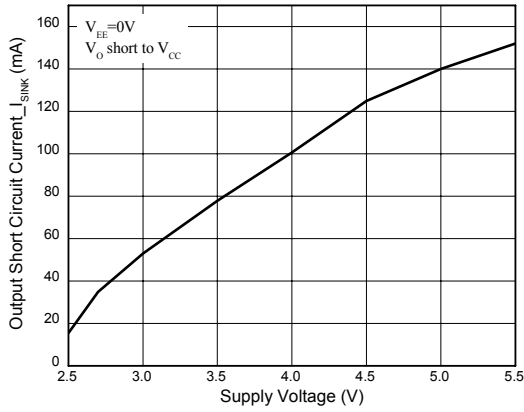

Figure 8. Output Short Circuit Current vs. Supply Voltage

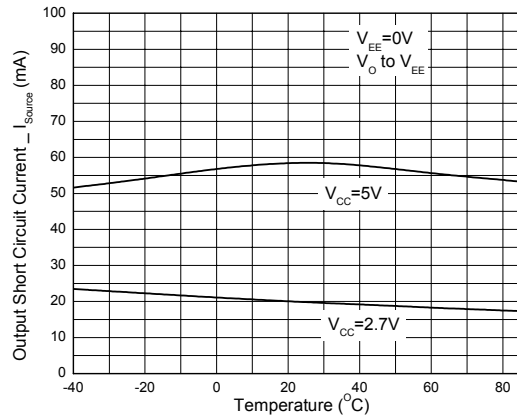

Figure 9. Output Short Circuit Current vs. Temperature

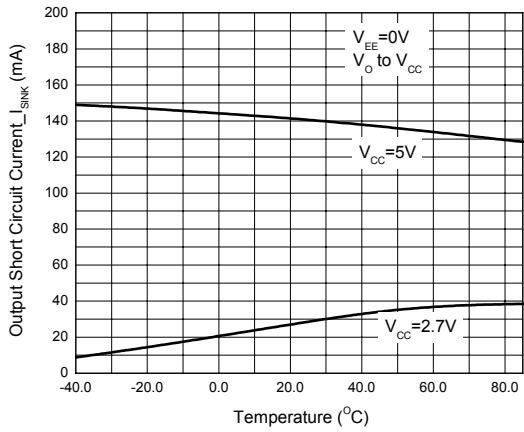

Figure 10. Output Short Circuit Current vs. Temperature

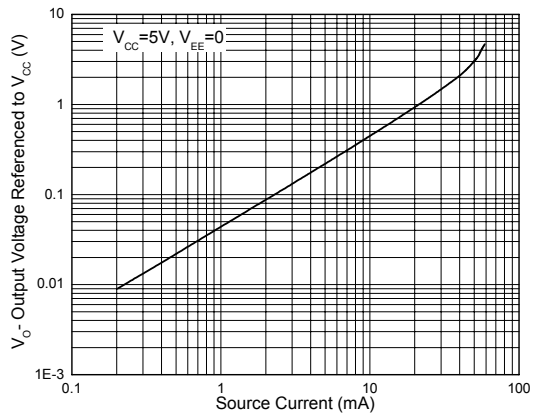

Figure 11. Output Voltage vs. Output Source Current



Typical Performance Characteristics (Continued)

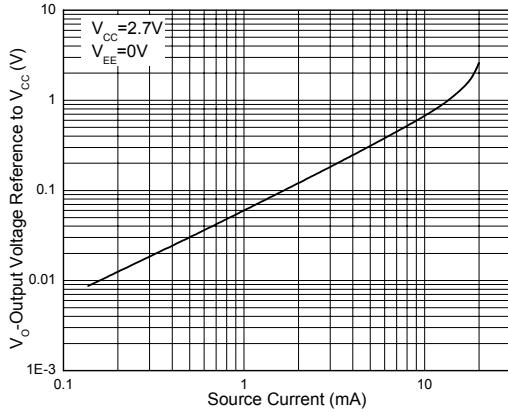

Figure 12. Output Voltage vs. Output Source Current

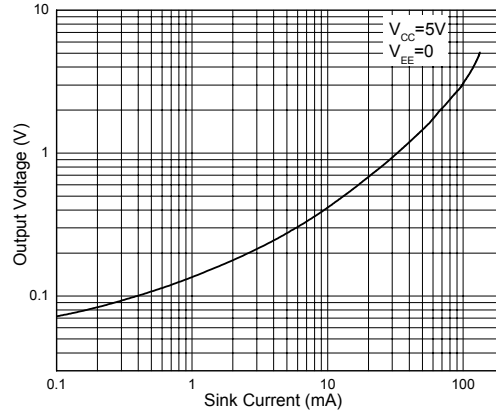

Figure 13. Output Voltage vs. Output Sink Current

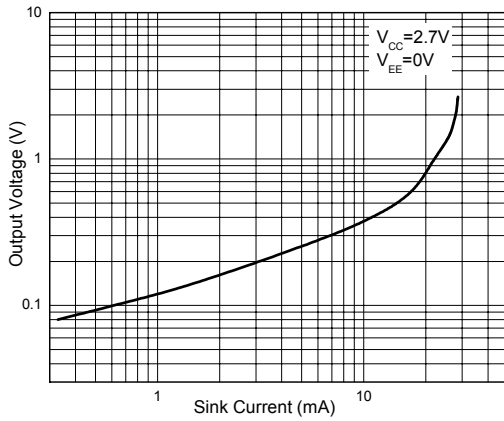

Figure 14. Output Voltage vs. Output Sink Current

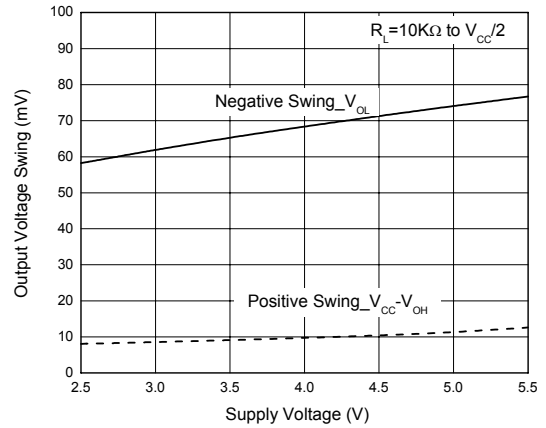

Figure 15. Output Voltage Swing vs. Supply Voltage



Typical Performance Characteristics (Continued)

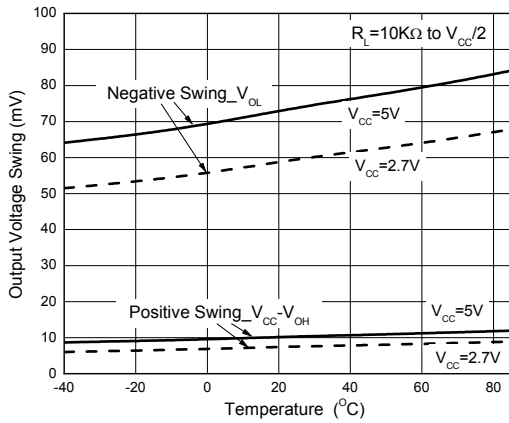

Figure 16. Output Voltage Swing vs. Temperature

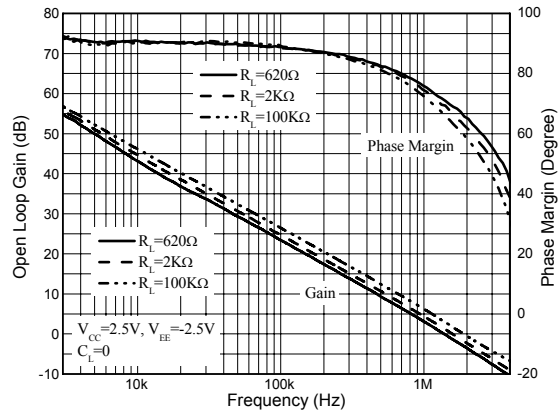

Figure 17. Gain and Phase vs. Frequency and Resistive Load

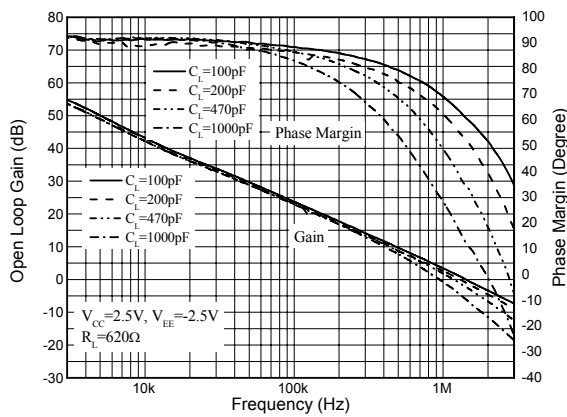

Figure 18. Gain and Phase vs. Frequency and Capacitive Load

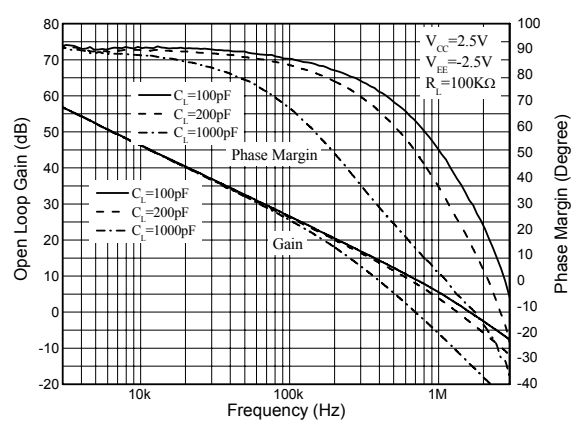

Figure 19. Gain and Phase vs. Frequency and Capacitive Load

Typical Performance Characteristics (Continued)

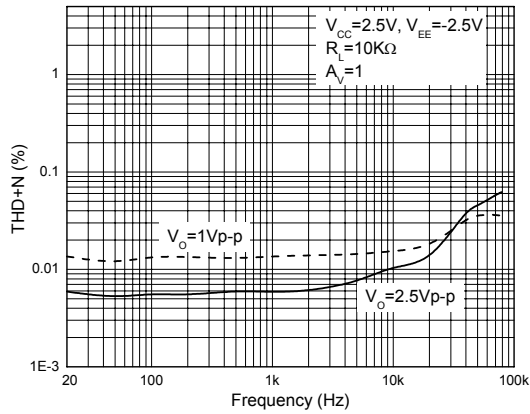

Figure 20. THD+N vs. Frequency

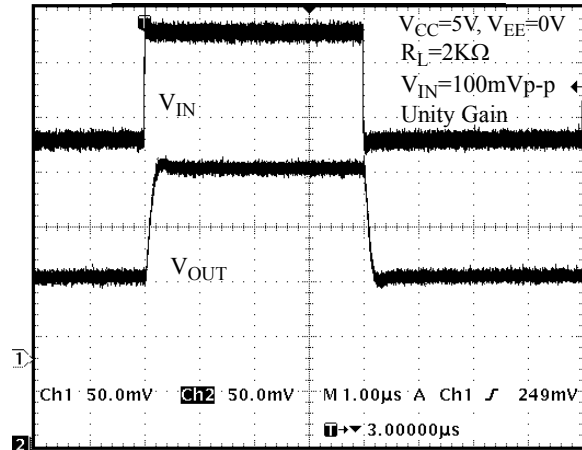

Figure 21. Non-Inverting Input Small Signal Pulse Response

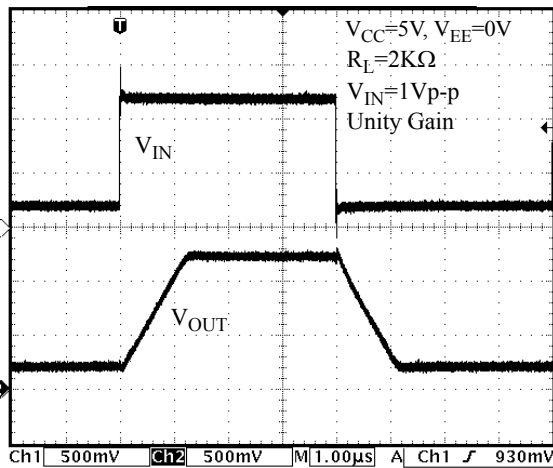

Figure 22. Non-Inverting Input Large Signal Pulse Response

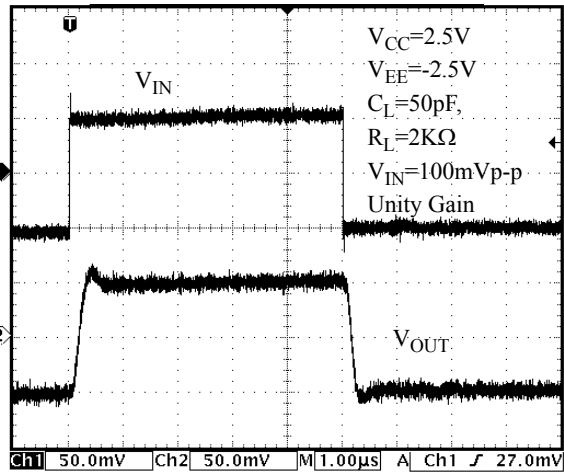

Figure 23. Non-Inverting Input Small Signal Response

Typical Performance Characteristics (Continued)

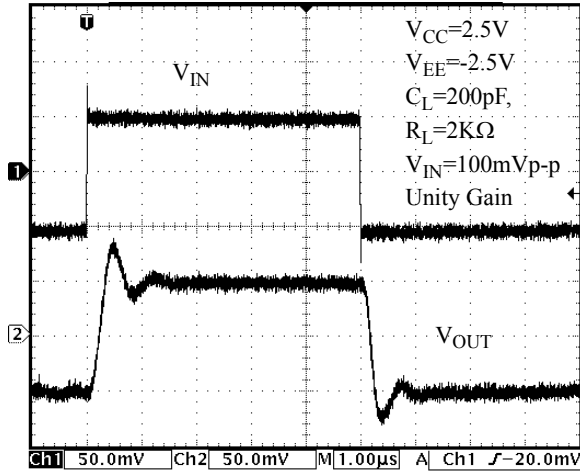

Figure 24. Non-Inverting Input Small Signal Response



Mechanical Dimensions

SOIC-8

Unit: mm(inch)

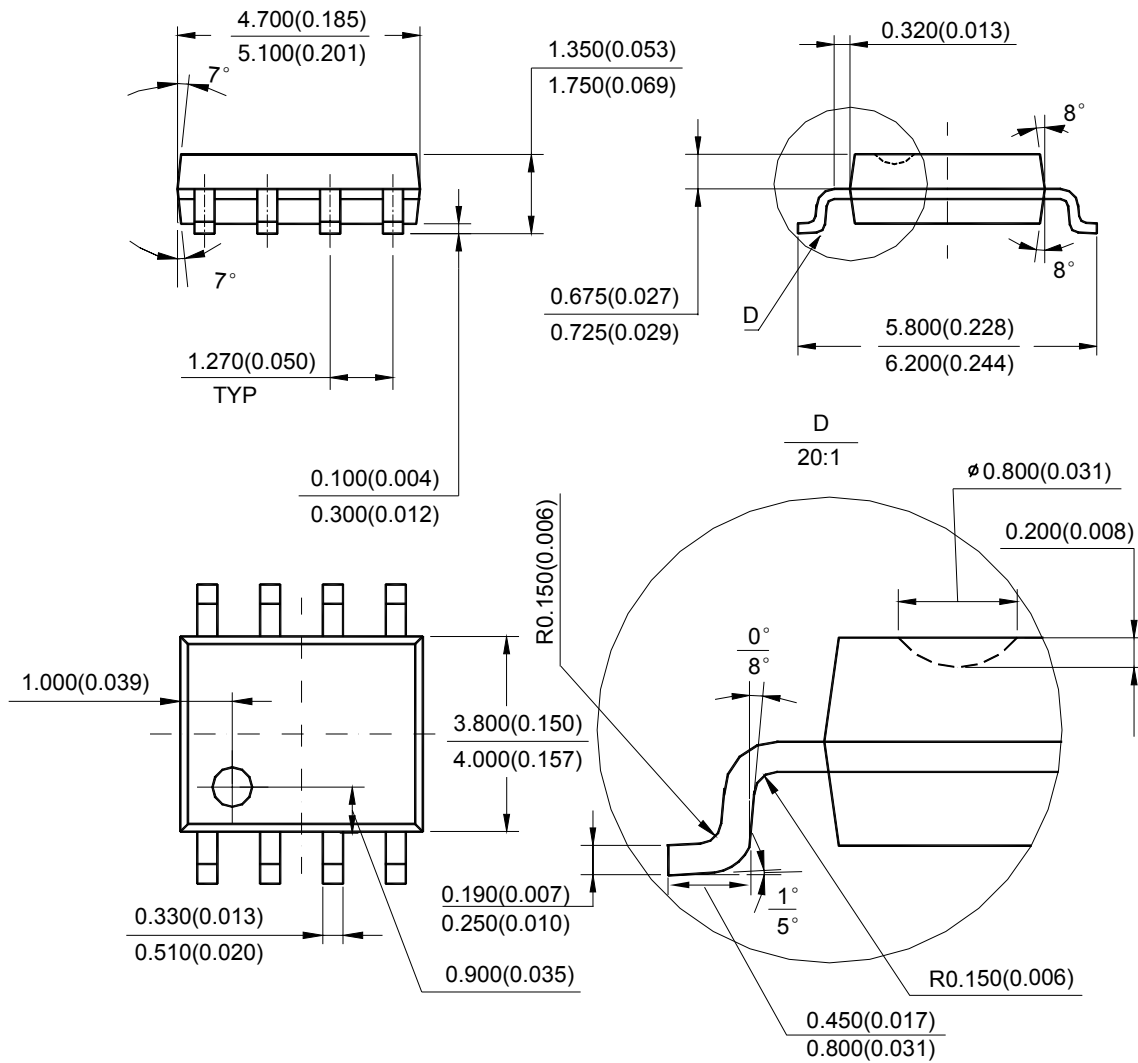

Note: Eject hole, oriented hole and mold mark is optional.



Mechanical Dimensions (Continued)

TSSOP-8

Unit: mm(inch)

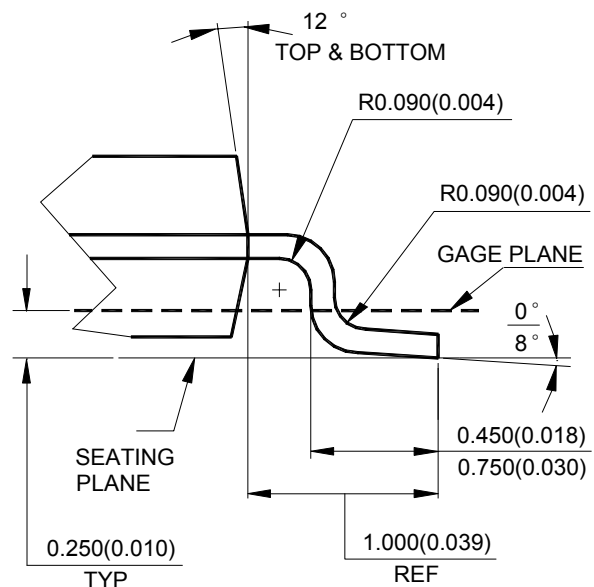
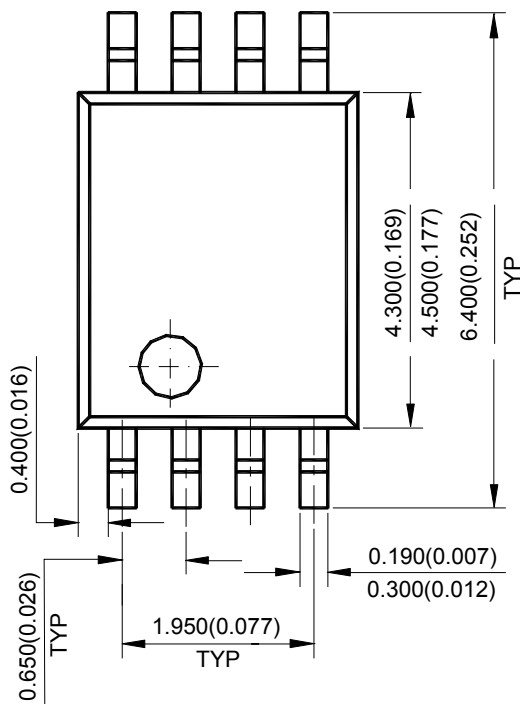
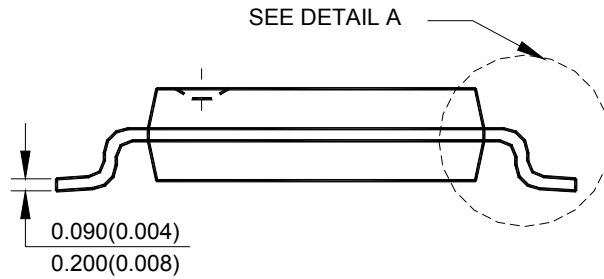
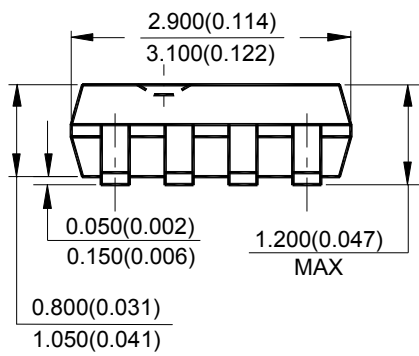

Note: Eject hole, oriented hole and mold mark is optional.



Mechanical Dimensions (Continued)

MSOP-8

Unit: mm(inch)

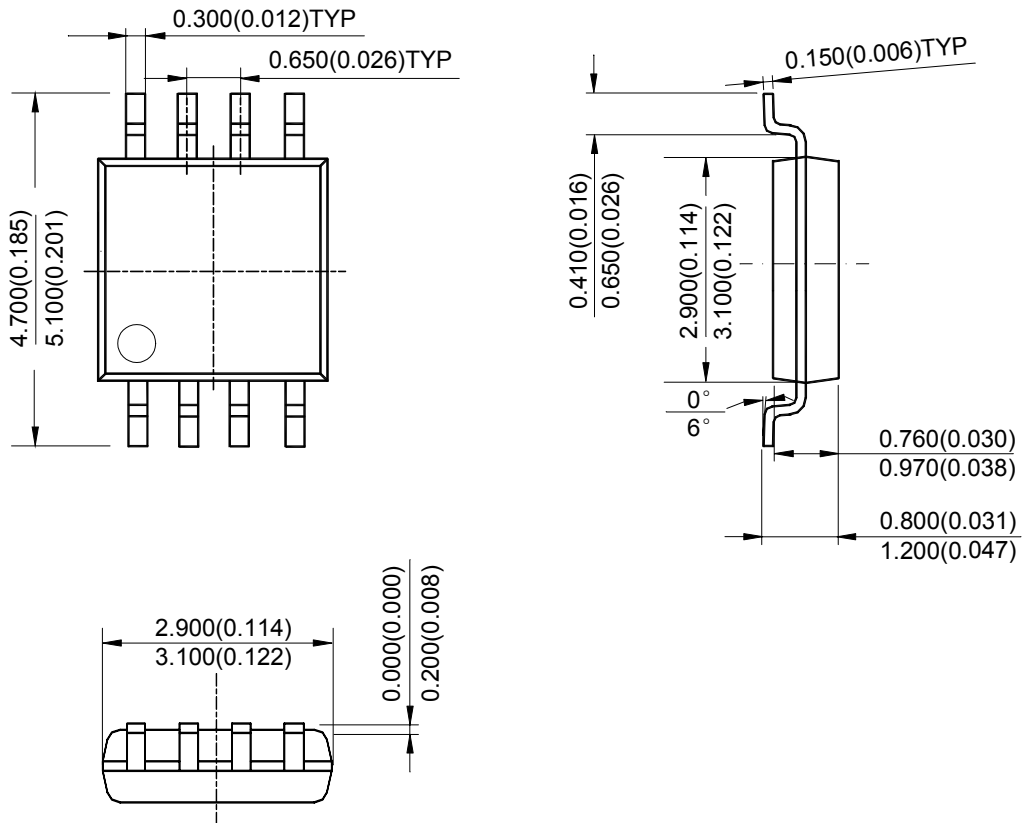

Note: Eject hole, oriented hole and mold mark is optional.



BCD Semiconductor Manufacturing Limited

<http://www.bcdsemi.com>

IMPORTANT NOTICE

BCD Semiconductor Manufacturing Limited reserves the right to make changes without further notice to any products or specifications herein. BCD Semiconductor Manufacturing Limited does not assume any responsibility for use of any its products for any particular purpose, nor does BCD Semiconductor Manufacturing Limited assume any liability arising out of the application or use of any its products or circuits. BCD Semiconductor Manufacturing Limited does not convey any license under its patent rights or other rights nor the rights of others.

MAIN SITE

- Headquarters

BCD Semiconductor Manufacturing Limited

No. 1600, Zi Xing Road, Shanghai ZiZhu Science-based Industrial Park, 200241, China
Tel: +86-21-24162266, Fax: +86-21-24162277

- Wafer Fab

Shanghai SIM-BCD Semiconductor Manufacturing Co., Ltd.

800 Yi Shan Road, Shanghai 200233, China
Tel: +86-21-6485 1491, Fax: +86-21-5450 0008

REGIONAL SALES OFFICE

Shenzhen Office

Shanghai SIM-BCD Semiconductor Manufacturing Co., Ltd., Shenzhen Office

Unit A Room 1203, Skyworth Bldg., Gaoxin Ave. 1.S., Nanshan District, Shenzhen, China
Tel: +86-755-8826 7951
Fax: +86-755-8826 7865

Taiwan Office

BCD Semiconductor (Taiwan) Company Limited

4F, 298-1, Rui Guang Road, Nei-Hu District, Taipei, Taiwan
Tel: +886-2-2656 2808
Fax: +886-2-2656 2806

USA Office

BCD Semiconductor Corp.

30920 Huntwood Ave. Hayward, CA 94544, USA
Tel : +1-510-324-2988
Fax: +1-510-324-2788

Компания «Life Electronics» занимается поставками электронных компонентов импортного и отечественного производства от производителей и со складов крупных дистрибьюторов Европы, Америки и Азии.

С конца 2013 года компания активно расширяет линейку поставок компонентов по направлению коаксиальный кабель, кварцевые генераторы и конденсаторы (керамические, пленочные, электролитические), за счёт заключения дистрибьюторских договоров

Мы предлагаем:

- Конкуренспособные цены и скидки постоянным клиентам.
- Специальные условия для постоянных клиентов.
- Подбор аналогов.
- Поставку компонентов в любых объемах, удовлетворяющих вашим потребностям.
- Приемлемые сроки поставки, возможна ускоренная поставка.
- Доставку товара в любую точку России и стран СНГ.
- Комплексную поставку.
- Работу по проектам и поставку образцов.
- Формирование склада под заказчика.
- Сертификаты соответствия на поставляемую продукцию (по желанию клиента).
- Тестирование поставляемой продукции.
- Поставку компонентов, требующих военную и космическую приемку.
- Входной контроль качества.
- Наличие сертификата ISO.

В составе нашей компании организован Конструкторский отдел, призванный помогать разработчикам, и инженерам.

Конструкторский отдел помогает осуществить:

- Регистрацию проекта у производителя компонентов.
- Техническую поддержку проекта.
- Защиту от снятия компонента с производства.
- Оценку стоимости проекта по компонентам.
- Изготовление тестовой платы монтаж и пусконаладочные работы.



Тел: +7 (812) 336 43 04 (многоканальный)

Email: org@lifeelectronics.ru