

To our customers,

Old Company Name in Catalogs and Other Documents

On April 1st, 2010, NEC Electronics Corporation merged with Renesas Technology Corporation, and Renesas Electronics Corporation took over all the business of both companies. Therefore, although the old company name remains in this document, it is a valid Renesas Electronics document. We appreciate your understanding.

Renesas Electronics website: <http://www.renesas.com>

April 1st, 2010
Renesas Electronics Corporation

Issued by: Renesas Electronics Corporation (<http://www.renesas.com>)

Send any inquiries to <http://www.renesas.com/inquiry>.

Notice

1. All information included in this document is current as of the date this document is issued. Such information, however, is subject to change without any prior notice. Before purchasing or using any Renesas Electronics products listed herein, please confirm the latest product information with a Renesas Electronics sales office. Also, please pay regular and careful attention to additional and different information to be disclosed by Renesas Electronics such as that disclosed through our website.
2. Renesas Electronics does not assume any liability for infringement of patents, copyrights, or other intellectual property rights of third parties by or arising from the use of Renesas Electronics products or technical information described in this document. No license, express, implied or otherwise, is granted hereby under any patents, copyrights or other intellectual property rights of Renesas Electronics or others.
3. You should not alter, modify, copy, or otherwise misappropriate any Renesas Electronics product, whether in whole or in part.
4. Descriptions of circuits, software and other related information in this document are provided only to illustrate the operation of semiconductor products and application examples. You are fully responsible for the incorporation of these circuits, software, and information in the design of your equipment. Renesas Electronics assumes no responsibility for any losses incurred by you or third parties arising from the use of these circuits, software, or information.
5. When exporting the products or technology described in this document, you should comply with the applicable export control laws and regulations and follow the procedures required by such laws and regulations. You should not use Renesas Electronics products or the technology described in this document for any purpose relating to military applications or use by the military, including but not limited to the development of weapons of mass destruction. Renesas Electronics products and technology may not be used for or incorporated into any products or systems whose manufacture, use, or sale is prohibited under any applicable domestic or foreign laws or regulations.
6. Renesas Electronics has used reasonable care in preparing the information included in this document, but Renesas Electronics does not warrant that such information is error free. Renesas Electronics assumes no liability whatsoever for any damages incurred by you resulting from errors in or omissions from the information included herein.
7. Renesas Electronics products are classified according to the following three quality grades: “Standard”, “High Quality”, and “Specific”. The recommended applications for each Renesas Electronics product depends on the product’s quality grade, as indicated below. You must check the quality grade of each Renesas Electronics product before using it in a particular application. You may not use any Renesas Electronics product for any application categorized as “Specific” without the prior written consent of Renesas Electronics. Further, you may not use any Renesas Electronics product for any application for which it is not intended without the prior written consent of Renesas Electronics. Renesas Electronics shall not be in any way liable for any damages or losses incurred by you or third parties arising from the use of any Renesas Electronics product for an application categorized as “Specific” or for which the product is not intended where you have failed to obtain the prior written consent of Renesas Electronics. The quality grade of each Renesas Electronics product is “Standard” unless otherwise expressly specified in a Renesas Electronics data sheets or data books, etc.
 - “Standard”: Computers; office equipment; communications equipment; test and measurement equipment; audio and visual equipment; home electronic appliances; machine tools; personal electronic equipment; and industrial robots.
 - “High Quality”: Transportation equipment (automobiles, trains, ships, etc.); traffic control systems; anti-disaster systems; anti-crime systems; safety equipment; and medical equipment not specifically designed for life support.
 - “Specific”: Aircraft; aerospace equipment; submersible repeaters; nuclear reactor control systems; medical equipment or systems for life support (e.g. artificial life support devices or systems), surgical implantations, or healthcare intervention (e.g. excision, etc.), and any other applications or purposes that pose a direct threat to human life.
8. You should use the Renesas Electronics products described in this document within the range specified by Renesas Electronics, especially with respect to the maximum rating, operating supply voltage range, movement power voltage range, heat radiation characteristics, installation and other product characteristics. Renesas Electronics shall have no liability for malfunctions or damages arising out of the use of Renesas Electronics products beyond such specified ranges.
9. Although Renesas Electronics endeavors to improve the quality and reliability of its products, semiconductor products have specific characteristics such as the occurrence of failure at a certain rate and malfunctions under certain use conditions. Further, Renesas Electronics products are not subject to radiation resistance design. Please be sure to implement safety measures to guard them against the possibility of physical injury, and injury or damage caused by fire in the event of the failure of a Renesas Electronics product, such as safety design for hardware and software including but not limited to redundancy, fire control and malfunction prevention, appropriate treatment for aging degradation or any other appropriate measures. Because the evaluation of microcomputer software alone is very difficult, please evaluate the safety of the final products or system manufactured by you.
10. Please contact a Renesas Electronics sales office for details as to environmental matters such as the environmental compatibility of each Renesas Electronics product. Please use Renesas Electronics products in compliance with all applicable laws and regulations that regulate the inclusion or use of controlled substances, including without limitation, the EU RoHS Directive. Renesas Electronics assumes no liability for damages or losses occurring as a result of your noncompliance with applicable laws and regulations.
11. This document may not be reproduced or duplicated, in any form, in whole or in part, without prior written consent of Renesas Electronics.
12. Please contact a Renesas Electronics sales office if you have any questions regarding the information contained in this document or Renesas Electronics products, or if you have any other inquiries.

(Note 1) “Renesas Electronics” as used in this document means Renesas Electronics Corporation and also includes its majority-owned subsidiaries.

(Note 2) “Renesas Electronics product(s)” means any product developed or manufactured by or for Renesas Electronics.

PS9587, PS9587L1, PS9587L2, PS9587L3

HIGH CMR, 10 Mbps OPEN COLLECTOR OUTPUT TYPE 8-PIN DIP HIGH-SPEED PHOTOCOUPLER FOR CREEPAGE DISTANCE OF 8 mm

–NEPOC Series–

DESCRIPTION

The PS9587, PS9587L1, PS9587L2 and PS9587L3 are optically coupled isolators containing a GaAlAs LED on the input side and a photo diode and a signal processing circuit on the output side on one chip.

The PS9587L1 and PS9587L2 are designed specifically for long creepage-distance as well as high common mode transient immunity (CMR) and high speed digital output type. Consequently, they are suitable for high speed logic interface that needs long creepage-distance (8 mm) on mounting.

The PS9587L1 is lead bending type for long creepage distance.

The PS9587L2 is lead bending type for long creepage distance (Gull-wing) for surface mount.

The PS9587L3 is lead bending type (Gull-wing) for surface mounting.

FEATURES

- Long creepage distance (8 mm MIN.: PS9587L1, PS9587L2)
- High common mode transient immunity ($CM_H, CM_L = \pm 15 \text{ kV}/\mu\text{s}$ MIN.)
- High isolation voltage ($BV = 5\,000 \text{ Vr.m.s.}$)
- High-speed response (10 Mbps)
- Pulse width distortion ($|t_{PHL} - t_{PLH}| = 10 \text{ ns TYP.}$)
- Open collector output
- Ordering number of tape product: PS9587L2-E3: 1 000 pcs/reel
: PS9587L3-E3: 1 000 pcs/reel
- Pb-Free product
- Safety standards
 - UL approved: No. E72422
 - <R> • CSA approved: No. CA 101391 (CA5A, CAN/CSA-C22.2 60065, 60950)
 - BSI approved: No. 8937, 8938
 - SEMKO approved: No. 615433
 - NEMKO approved: No. P06207243
 - DEMKO approved: No. 314091
 - FIMKO approved: No. FI 22827
 - <R> • DIN EN60747-5-2 (VDE0884 Part2) approved: No. 40019182 (Option)



APPLICATIONS

- FA Network
- Measurement equipment
- PDP

The information in this document is subject to change without notice. Before using this document, please confirm that this is the latest version.
Not all products and/or types are available in every country. Please check with an NEC Electronics sales representative for availability and additional information.

<R> PACKAGE DIMENSIONS (UNIT: mm)

DIP Type



Lead Bending Type (Gull-wing) For Surface Mount



Lead Bending Type For Long Creepage Distance



Lead Bending Type For Long Creepage Distance (Gull-wing) For Surface Mount

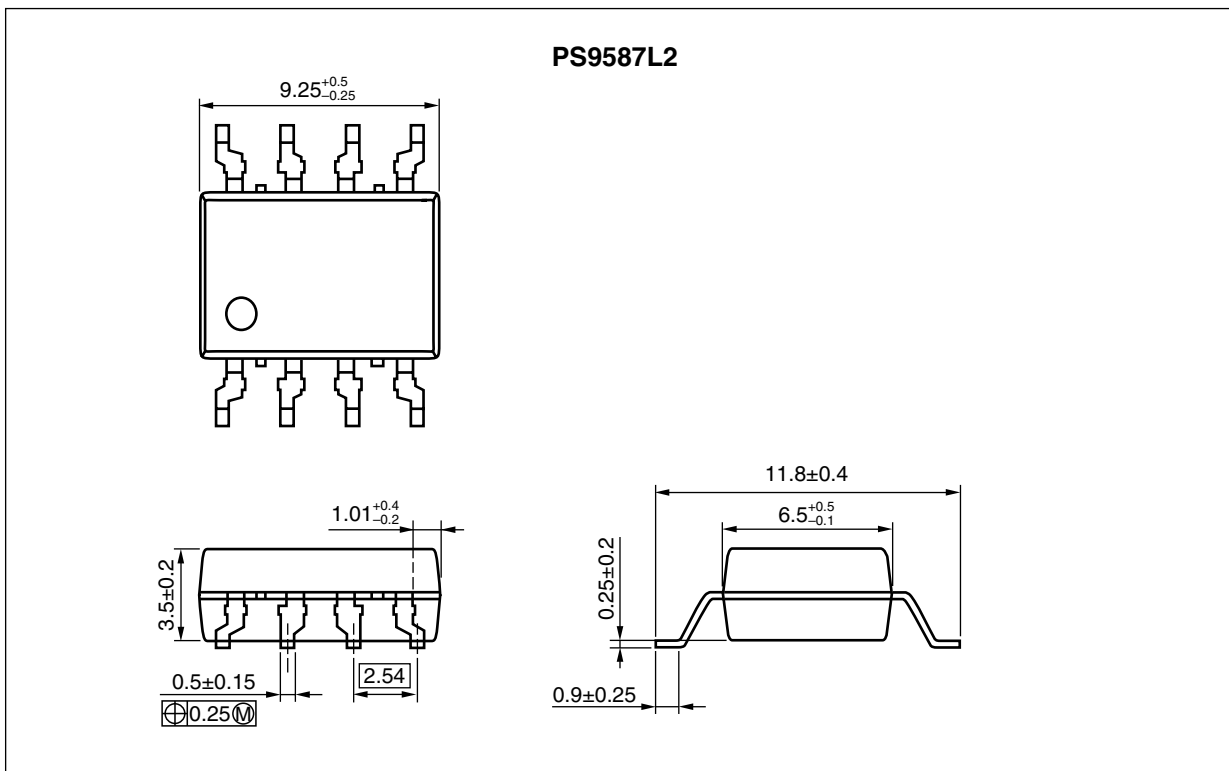

PHOTOCOUPLER CONSTRUCTION

Parameter	PS9587, PS9587L3	PS9587L1, PS9587L2
Air Distance (MIN.)	7 mm	8 mm
Outer Creepage Distance (MIN.)	7 mm	8 mm
Isolation Distance (MIN.)	0.4 mm	0.4 mm

FUNCTIONAL DIAGRAM



<R> MARKING EXAMPLE



ORDERING INFORMATION

Part Number	Order Number	Solder Plating Specification	Packing Style	Safety Standard Approval	Application Part Number* ¹			
PS9587	PS9587-AX	Pb-Free (Ni/Pd/Au)	Magazine case 50 pcs	Standard products (UL, CSA, BSI, SEMKO, NEMKO, DEMKO, FIMKO approved)	PS9587			
PS9587L1	PS9587L1-AX				PS9587L1			
PS9587L2	PS9587L2-AX				PS9587L2			
PS9587L3	PS9587L3-AX				PS9587L3			
PS9587L2-E3	PS9587L2-E3-AX		Embossed Tape 1 000 pcs/reel			PS9587L2		
PS9587L3-E3	PS9587L3-E3-AX					PS9587L3		
PS9587-V	PS9587-V-AX		Magazine case 50 pcs		DIN EN60747-5-2 (VDE0884 Part2) Approved (Option)	PS9587		
PS9587L1-V	PS9587L1-V-AX					PS9587L1		
PS9587L2-V	PS9587L2-V-AX					PS9587L2		
PS9587L3-V	PS9587L3-V-AX					PS9587L3		
PS9587L2-V-E3	PS9587L2-V-E3-AX			Embossed Tape 1 000 pcs/reel				PS9587L2
PS9587L3-V-E3	PS9587L3-V-E3-AX							PS9587L3

*1 For the application of the Safety Standard, following part number should be used.

ABSOLUTE MAXIMUM RATINGS (T_A = 25°C, unless otherwise specified)

Parameter		Symbol	Ratings	Unit
Diode	Forward Current ^{*1}	I _F	30	mA
	Reverse Voltage	V _R	5	V
Detector	Supply Voltage	V _{CC}	7	V
	Output Voltage	V _O	7	V
	Output Current	I _O	25	mA
	Power Dissipation ^{*2}	P _C	40	mW
Isolation Voltage ^{*3}		BV	5 000	Vr.m.s.
Operating Ambient Temperature		T _A	-40 to +85	°C
Storage Temperature		T _{stg}	-55 to +125	°C

*1 Reduced to 0.3 mA/°C at T_A = 25°C or more.

*2 Applies to output pin V_O (Collector pin). Reduced to 1.5 mW/°C at T_A = 65°C or more.

*3 AC voltage for 1 minute at T_A = 25°C, RH = 60% between input and output.

Pins 1-4 shorted together, 5-8 shorted together.

RECOMMENDED OPERATING CONDITIONS (T_A = 25°C)

Parameter	Symbol	MIN.	TYP.	MAX.	Unit
High Level Input Current	I _{FH}	6.3	10	12.0	mA
Low Level Input Voltage	V _{FL}	0		0.8	V
Supply Voltage	V _{CC}	4.5	5.0	5.5	V
TTL (R _L = 1 kΩ, loads)	N			5	
Pull-up Resistance	R _L	330		4 k	Ω

ELECTRICAL CHARACTERISTICS (T_A = -40 to +85°C, unless otherwise specified)

Parameter		Symbol	Conditions	MIN.	TYP. ¹⁾	MAX.	Unit
Diode	Forward Voltage	V _F	I _F = 10 mA, T _A = 25°C	1.4	1.65	1.8	V
	Reverse Current	I _R	V _R = 3 V, T _A = 25°C			10	μA
	Terminal Capacitance	C _t	V _F = 0 V, f = 1 MHz, T _A = 25°C		30	150	pF
Detector	High Level Output Current	I _{OH}	V _{CC} = V _O = 5.5 V, V _F = 0.8 V		1	100	μA
	Low Level Output Voltage ²⁾	V _{OL}	V _{CC} = 5.5 V, I _F = 5 mA, I _{OL} = 13 mA		0.2	0.6	V
	High Level Supply Current	I _{CCH}	V _{CC} = 5.5 V, I _F = 0 mA, V _O = Open		5	8	mA
	Low Level Supply Current	I _{CCL}	V _{CC} = 5.5 V, I _F = 10 mA, V _O = Open		9	11	mA
Coupled	Threshold Input Current (H → L)	I _{FHL}	T _A = 25°C			3.3	mA
			V _{CC} = 5 V, V _O = 0.8 V, R _L = 350 Ω		1.5	5	
	Isolation Resistance	R _{I-O}	V _{I-O} = 1 kV _{DC} , R _H = 40 to 60%, T _A = 25°C	10 ¹¹			Ω
	Isolation Capacitance	C _{I-O}	V = 0 V, f = 1 MHz, T _A = 25°C		0.9	5	pF
	Propagation Delay Time (H → L) ³⁾	t _{PHL}	V _{CC} = 5 V, T _A = 25°C V _{THHL} = V _{THLH} = 1.5 V,		35	75	ns
						100	
	Propagation Delay Time (L → H) ³⁾	t _{PLH}	R _L = 350 Ω, T _A = 25°C I _F = 7.5 mA, C _L = 15 pF		45	75	ns
						100	
	Rise Time	t _r			20		ns
	Fall Time	t _f			10		ns
Pulse Width Distortion (PWD) ³⁾	t _{PHL} -t _{PLH}			10	50	ns	
Propagation Delay Skew	t _{PSK}					60	ns
Common Mode Transient Immunity at High Level Output ⁴⁾	CM _H	V _{CC} = 5 V, T _A = 25°C, I _F = 0 mA, V _{O(MIN.)} = 2 V, V _{CM} = 1.5 kV, R _L = 350 Ω		15			kV/μs
Common Mode Transient Immunity at Low Level Output ⁴⁾	CM _L	V _{CC} = 5 V, T _A = 25°C, I _F = 7.5 mA, V _{O(MAX.)} = 0.8 V, V _{CM} = 1.5 kV, R _L = 350 Ω		15			kV/μs

*1 Typical values at $T_A = 25^\circ\text{C}$

*2 Because V_{OL} of 2 V or more may be output when LED current is input and when output power supply is on and off, confirm the characteristics (operation with the power supply on and off) during design, before using this device.

*3 Test circuit for propagation delay time



Remark C_L includes probe and stray wiring capacitance.

*4 Test circuit for common mode transient immunity



Remark C_L includes probe and stray wiring capacitance.

USAGE CAUTIONS

1. This product is weak for static electricity by designed with high-speed integrated circuit so protect against static electricity when handling.
2. By-pass capacitor of more than 0.1 μF is used between V_{CC} and GND near device. Also, ensure that the distance between the leads of the photocoupler and capacitor is no more than 10 mm.
3. Pins 1, 4 (which is an NC^{*1} pin) can either be connected directly to the GND pin on the LED side or left open. Also, Pin 7 (which is an NC^{*1} pin) can either be connected directly to the GND pin on the detector side or left open.

<R>

Unconnected pins should not be used as a bypass for signals or for any other similar purpose because this may degrade the internal noise environment of the device.

*1 NC: Non-Connection (No Connection)

4. Avoid storage at a high temperature and high humidity.

TYPICAL CHARACTERISTICS (TA = 25°C, unless otherwise specified)



Remark The graphs indicate nominal characteristics.

THRESHOLD INPUT CURRENT vs. AMBIENT TEMPERATURE

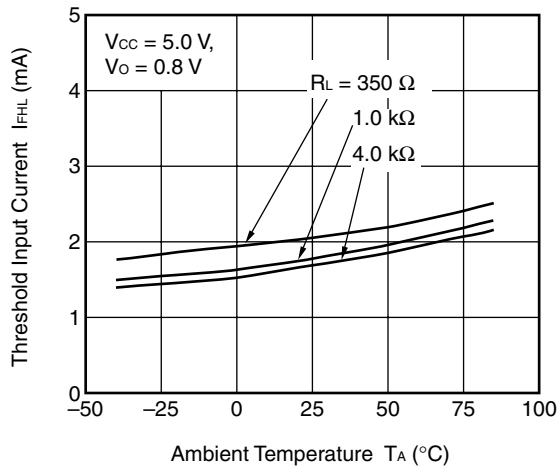

PROPAGATION DELAY TIME vs. AMBIENT TEMPERATURE



PULSE WIDTH DISTORTION vs. AMBIENT TEMPERATURE

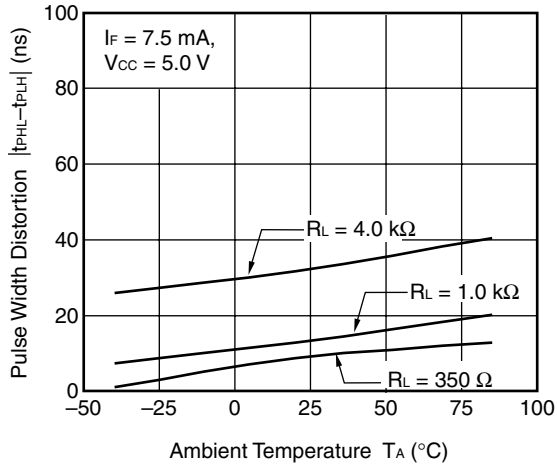

SWITCHING TIME vs. AMBIENT TEMPERATURE



PROPAGATION DELAY TIME vs. FORWARD CURRENT

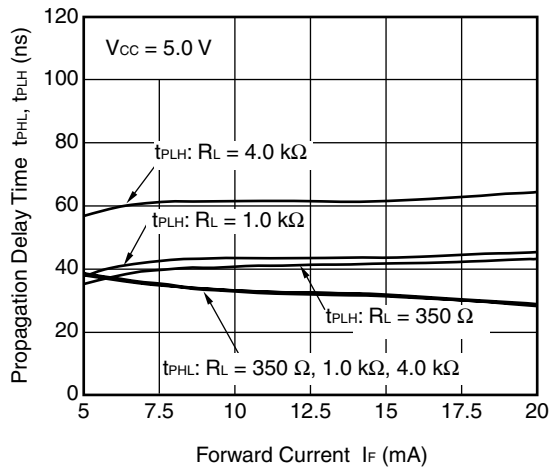

PULSE WIDTH DISTORTION vs. FORWARD CURRENT

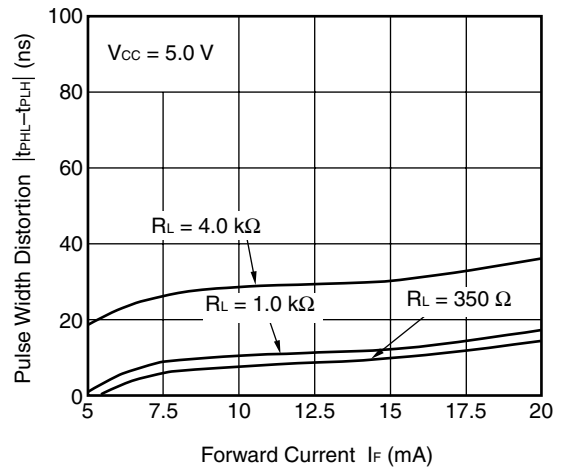

Remark The graphs indicate nominal characteristics.

TAPING SPECIFICATIONS (UNIT: mm)

Outline and Dimensions (Tape)

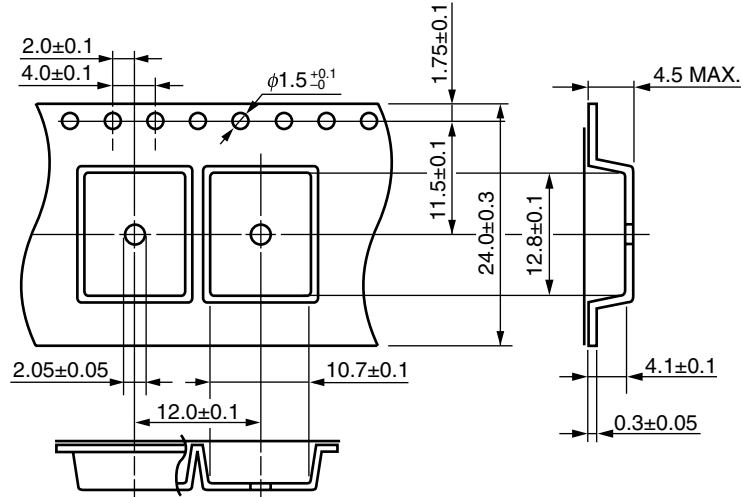

Tape Direction



Outline and Dimensions (Reel)



Packing: 1 000 pcs/reel

Outline and Dimensions (Tape)



Tape Direction



Outline and Dimensions (Reel)



RECOMMENDED MOUNT PAD DIMENSIONS (UNIT: mm)



NOTES ON HANDLING

1. Recommended soldering conditions

(1) Infrared reflow soldering

- Peak reflow temperature 260°C or below (package surface temperature)
- Time of peak reflow temperature 10 seconds or less
- Time of temperature higher than 220°C 60 seconds or less
- Time to preheat temperature from 120 to 180°C 120±30 s
- Number of reflows Three
- Flux Rosin flux containing small amount of chlorine (The flux with a maximum chlorine content of 0.2 Wt% is recommended.)

Recommended Temperature Profile of Infrared Reflow

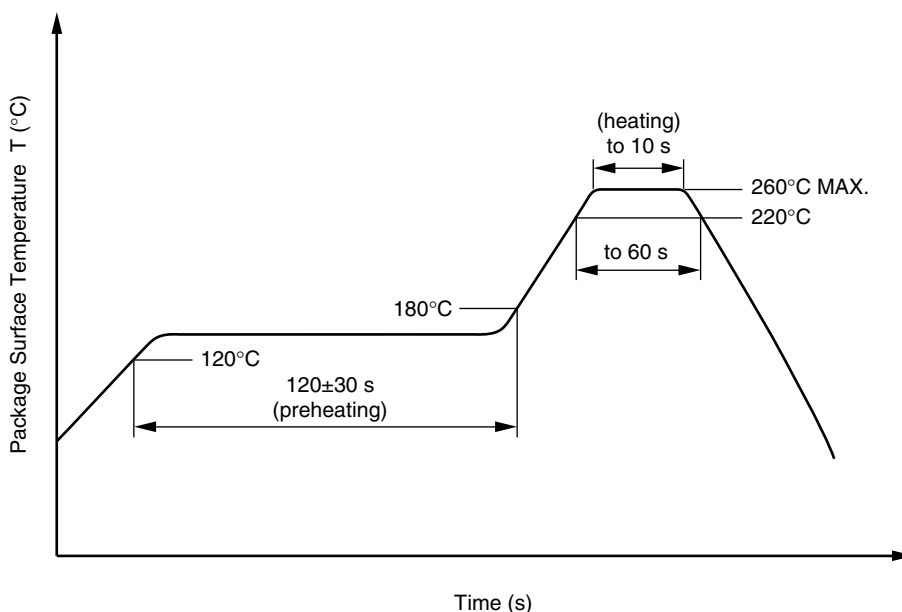

(2) Wave soldering

- Temperature 260°C or below (molten solder temperature)
- Time 10 seconds or less
- Preheating conditions 120°C or below (package surface temperature)
- Number of times One (Allowed to be dipped in solder including plastic mold portion.)
- Flux Rosin flux containing small amount of chlorine (The flux with a maximum chlorine content of 0.2 Wt% is recommended.)

(3) Soldering by Soldering Iron

- Peak Temperature (lead part temperature) 350°C or below
- Time (each pins) 3 seconds or less
- Flux Rosin flux containing small amount of chlorine (The flux with a maximum chlorine content of 0.2 Wt% is recommended.)

(a) Soldering of leads should be made at the point 1.5 to 2.0 mm from the root of the lead

(b) Please be sure that the temperature of the package would not be heated over 100°C

(4) Cautions

- Fluxes

Avoid removing the residual flux with freon-based and chlorine-based cleaning solvent.

2. Cautions regarding noise

Be aware that when voltage is applied suddenly between the photocoupler's input and output or between V_{CC}-GND at startup, the output transistor may enter the on state, even if the voltage is within the absolute maximum ratings.

<R> SPECIFICATION OF VDE MARKS LICENSE DOCUMENT

Parameter	Symbol	Speck	Unit
Climatic test class (IEC 60068-1/DIN EN 60068-1)		40/85/21	
Dielectric strength maximum operating isolation voltage	U_{IORM}	1 130	V_{peak}
Test voltage (partial discharge test, procedure a for type test and random test) $U_{pr} = 1.5 \times U_{IORM}, P_d < 5 \text{ pC}$	U_{pr}	1 695	V_{peak}
Test voltage (partial discharge test, procedure b for all devices) $U_{pr} = 1.875 \times U_{IORM}, P_d < 5 \text{ pC}$	U_{pr}	2 119	V_{peak}
Highest permissible overvoltage	U_{TR}	8 000	V_{peak}
Degree of pollution (DIN EN 60664-1 VDE0110 Part 1)		2	
Comparative tracking index (IEC 60112/DIN EN 60112 (VDE 0303 Part 11))	CTI	175	
Material group (DIN EN 60664-1 VDE0110 Part 1)		III a	
Storage temperature range	T_{stg}	-55 to +125	°C
Operating temperature range	T_A	-40 to +85	°C
Isolation resistance, minimum value $V_{IO} = 500 \text{ V dc at } T_A = 25^\circ\text{C}$ $V_{IO} = 500 \text{ V dc at } T_A \text{ MAX. at least } 100^\circ\text{C}$	Ris MIN. Ris MIN.	10^{12} 10^{11}	Ω Ω
Safety maximum ratings (maximum permissible in case of fault, see thermal derating curve)			
Package temperature	T_{si}	175	°C
Current (input current I_F , $P_{si} = 0$)	I_{si}	400	mA
Power (output or total power dissipation)	P_{si}	700	mW
Isolation resistance $V_{IO} = 500 \text{ V dc at } T_A = T_{si}$	Ris MIN.	10^9	Ω

- **The information in this document is current as of September, 2009. The information is subject to change without notice. For actual design-in, refer to the latest publications of NEC Electronics data sheets, etc., for the most up-to-date specifications of NEC Electronics products. Not all products and/or types are available in every country. Please check with an NEC Electronics sales representative for availability and additional information.**
- No part of this document may be copied or reproduced in any form or by any means without the prior written consent of NEC Electronics. NEC Electronics assumes no responsibility for any errors that may appear in this document.
- NEC Electronics does not assume any liability for infringement of patents, copyrights or other intellectual property rights of third parties by or arising from the use of NEC Electronics products listed in this document or any other liability arising from the use of such products. No license, express, implied or otherwise, is granted under any patents, copyrights or other intellectual property rights of NEC Electronics or others.
- Descriptions of circuits, software and other related information in this document are provided for illustrative purposes in semiconductor product operation and application examples. The incorporation of these circuits, software and information in the design of a customer's equipment shall be done under the full responsibility of the customer. NEC Electronics assumes no responsibility for any losses incurred by customers or third parties arising from the use of these circuits, software and information.
- While NEC Electronics endeavors to enhance the quality and safety of NEC Electronics products, customers agree and acknowledge that the possibility of defects thereof cannot be eliminated entirely. In addition, NEC Electronics products are not taken measures to prevent radioactive rays in the product design. When customers use NEC Electronics products with their products, customers shall, on their own responsibility, incorporate sufficient safety measures such as redundancy, fire-containment and anti-failure features to their products in order to avoid risks of the damages to property (including public or social property) or injury (including death) to persons, as the result of defects of NEC Electronics products.
- NEC Electronics products are classified into the following three quality grades: "Standard", "Special" and "Specific".

The "Specific" quality grade applies only to NEC Electronics products developed based on a customer-designated "quality assurance program" for a specific application. The recommended applications of an NEC Electronics product depend on its quality grade, as indicated below. Customers must check the quality grade of each NEC Electronics product before using it in a particular application.

"Standard": Computers, office equipment, communications equipment, test and measurement equipment, audio and visual equipment, home electronic appliances, machine tools, personal electronic equipment and industrial robots.

"Special": Transportation equipment (automobiles, trains, ships, etc.), traffic control systems, anti-disaster systems, anti-crime systems, safety equipment and medical equipment (not specifically designed for life support).

"Specific": Aircraft, aerospace equipment, submersible repeaters, nuclear reactor control systems, life support systems and medical equipment for life support, etc.

The quality grade of NEC Electronics products is "Standard" unless otherwise expressly specified in NEC Electronics data sheets or data books, etc. If customers wish to use NEC Electronics products in applications not intended by NEC Electronics, they must contact an NEC Electronics sales representative in advance to determine NEC Electronics' willingness to support a given application.

(Note)

- (1) "NEC Electronics" as used in this statement means NEC Electronics Corporation and also includes its majority-owned subsidiaries.
- (2) "NEC Electronics products" means any product developed or manufactured by or for NEC Electronics (as defined above).

M8E0904E

<p>Caution GaAs Products</p>	<p>This product uses gallium arsenide (GaAs). GaAs vapor and powder are hazardous to human health if inhaled or ingested, so please observe the following points.</p> <ul style="list-style-type: none"> • Follow related laws and ordinances when disposing of the product. If there are no applicable laws and/or ordinances, dispose of the product as recommended below. <ol style="list-style-type: none"> 1. Commission a disposal company able to (with a license to) collect, transport and dispose of materials that contain arsenic and other such industrial waste materials. 2. Exclude the product from general industrial waste and household garbage, and ensure that the product is controlled (as industrial waste subject to special control) up until final disposal. • Do not burn, destroy, cut, crush, or chemically dissolve the product. • Do not lick the product or in any way allow it to enter the mouth.
-------------------------------------	---

Mouser Electronics

Authorized Distributor

Click to View Pricing, Inventory, Delivery & Lifecycle Information:

Renesas Electronics:

[PS9587L2-V-E3-AX](#) [PS9587L1-AX](#) [PS9587L3-AX](#) [PS9587L2-E3-AX](#) [PS9587-AX](#) [PS9587L1-V-AX](#) [PS9587L2-V-AX](#) [PS9587L3-E3-AX](#) [PS9587L3-V-AX](#) [PS9587L3-V-E3-AX](#) [PS9587-V-AX](#) [PS9587L2-AX](#)

Компания «Life Electronics» занимается поставками электронных компонентов импортного и отечественного производства от производителей и со складов крупных дистрибьюторов Европы, Америки и Азии.

С конца 2013 года компания активно расширяет линейку поставок компонентов по направлению коаксиальный кабель, кварцевые генераторы и конденсаторы (керамические, пленочные, электролитические), за счёт заключения дистрибьюторских договоров

Мы предлагаем:

- Конкурентоспособные цены и скидки постоянным клиентам.
- Специальные условия для постоянных клиентов.
- Подбор аналогов.
- Поставку компонентов в любых объемах, удовлетворяющих вашим потребностям.
- Приемлемые сроки поставки, возможна ускоренная поставка.
- Доставку товара в любую точку России и стран СНГ.
- Комплексную поставку.
- Работу по проектам и поставку образцов.
- Формирование склада под заказчика.
- Сертификаты соответствия на поставляемую продукцию (по желанию клиента).
- Тестирование поставляемой продукции.
- Поставку компонентов, требующих военную и космическую приемку.
- Входной контроль качества.
- Наличие сертификата ISO.

В составе нашей компании организован Конструкторский отдел, призванный помогать разработчикам, и инженерам.

Конструкторский отдел помогает осуществить:

- Регистрацию проекта у производителя компонентов.
- Техническую поддержку проекта.
- Защиту от снятия компонента с производства.
- Оценку стоимости проекта по компонентам.
- Изготовление тестовой платы монтаж и пусконаладочные работы.



Тел: +7 (812) 336 43 04 (многоканальный)

Email: org@lifeelectronics.ru