

Features

- RoHS compliant*
- Conductive plastic or cermet
- Linear and audio tapers
- PC board and bushing mount
- Gangable
- Metal bushing and shaft
- Sealed for board washing



51/53 - Sealed 1/2" (12.5 mm) Square Control

Electrical Characteristics ¹	Conductive Plastic	Cermet
Standard Resistance Range		
Linear	1 K ohms to 1 megohm.....	150 ohms to 1 megohm
Audio	1 K ohms to 1 megohm.....	1 K ohms to 1 megohm
Total Resistance Tolerance		
Linear Tapers	±10 % or ±20 %	±10 % or ±5 %
Audio Tapers	±10 % or ±20 %	±10 %
Independent Linearity	±5 %	±5 %
Absolute Minimum Resistance	2 ohms maximum	2 ohms maximum
Effective Electrical Angle	270 ° ±5 °	270 ° ±5 °
Contact Resistance Variation	2 %	2 %
Dielectric Withstanding Voltage (MIL-STD-202 – Method 301)		
Sea Level	1,500 VAC minimum	1,500 VAC minimum
70,000	500 VAC minimum	500 VAC minimum
Insulation Resistance	1,000 megohms minimum	1,000 megohms minimum
Power Rating At 70 °C (Derate To 0 At 125 °C) (Voltage Limited By Power Dissipation or 350 VAC, Whichever Is Less)		
Linear Tapers	0.5 watt	1.0 watt
Audio Tapers	0.25 watt	0.5 watt
Theoretical Resolution	Essentially infinite	Essentially infinite

Environmental Characteristics ¹	Conductive Plastic	Cermet
Operating Temperature Range	+1 °C to +125 °C	+1 °C to +125 °C
Storage Temperature Range	-55 °C to +125 °C	-55 °C to +125 °C
Temperature Coefficient Over Storage Temperature Range	±1,000 ppm/°C	±150 ppm/°C
Vibration (Single Section)	15 G	15 G
Total Resistance Shift	±2 % maximum	±2 % maximum
Voltage Ratio Shift	±5 % maximum	±5 % maximum
Shock (Single Section)	30 G	30 G
Total Resistance Shift	+2 % maximum	+2 % maximum
Voltage Ratio Shift	±5 % maximum	±5 % maximum
Load Life	1,000 hours	1,000 hours
Total Resistance Shift	±10 % TRS maximum	±5 % TRS maximum
Rotational Life (No Load)	50,000 cycles	25,000 cycles
Total Resistance Shift	±10 % TRS maximum	±10 % TRS maximum
Contact Resistance Variation @ 25,000 Cycles	±2 %	±4 %
Moisture Resistance (MIL-STD-202, Method 103, Condition B)		
Total Resistance Shift	±10 % TRS	±5 % TRS
IP Rating		
Entire Unit	IP64	IP64
Shaft/Bushing	IP65	IP65

Mechanical Characteristics	
Stop Strength	56 N-cm (5 lb.-in.)
Mechanical Angle	290 ° ±5 °
Torque	
Starting (Dual Sections)	+0.35 N-cm (+0.5 oz.-in.) maximum
Running (Single Section)	0.15 to 1.4 N-cm (0.2 to 2.0 oz.-in.)
Running (Dual Section)	0.35 to 1.8 N-cm (0.5 to 2.5 oz.-in.)
Detent (Single Section)	1.94 N-cm (2.75 oz.-in.) minimum
Mounting (Torque on Bushing)	1.7 to 2.0 N-m (15 to 18 lb.-in.) maximum
Weight (Single Section)	5.5 grams
(Additional Section)	3.0 grams
Terminals	PC pin or solder lug
Soldering Condition	Recommended hand soldering using Sn95/Ag5 no clean solder, 0.025" wire diameter. Maximum temperature 399 °C (750 °F) for 3 seconds. No wash process to be used with no clean flux. Part can be wave soldered at 260 °C (500 °F) for 5 seconds, no wash process with no clean flux.
Marking	Manufacturer's trademark, part number, resistance value and date code.
Ganging (Multiple Section Potentiometer)	2 sections maximum**
Hardware	One lockwasher and one mounting nut is shipped with each potentiometer, except where noted in the part number.

¹At room ambient: +25 °C nominal and 50 % relative humidity nominal, except as noted.

** Additional sections available on special request with higher minimum order quantities.

51/53 - Sealed 1/2" (12.5 mm) Square Control

BOURNS®

Product Dimensions

PACKAGE DIMENSIONS

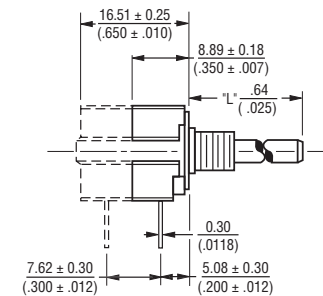

(SINGLE AND DUAL MODULE SHOWN)

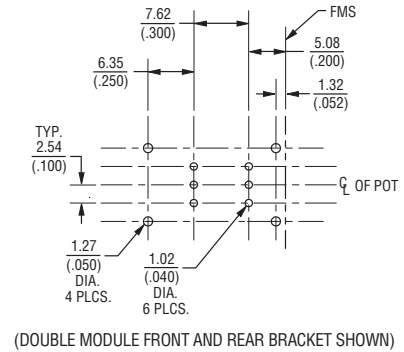
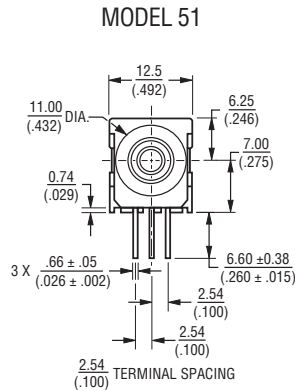

(DOUBLE MODULE FRONT AND REAR BRACKET SHOWN)

PACKAGE DIMENSIONS PCB MOUNTING BRACKET

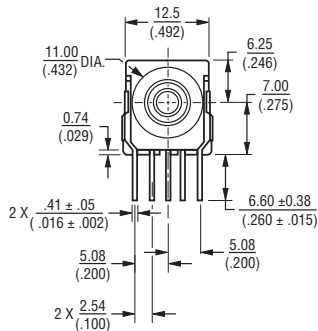
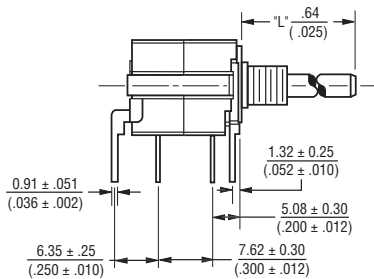

SOLDER LUG TERMINALS MODEL 53

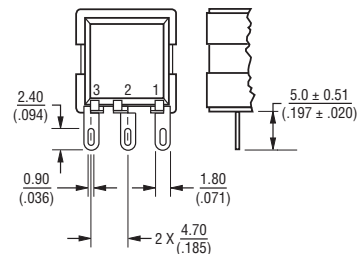

ELECTRICAL SCHEMATIC

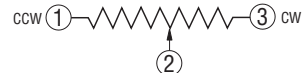

ANTI-ROTATION LUG (Style "A" Shown)

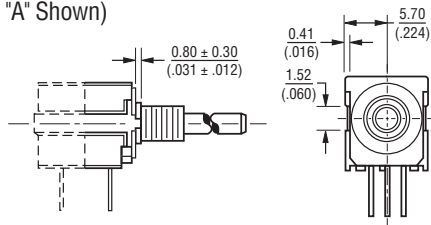

SHAFT FLAT ORIENTATION

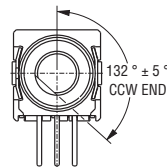

SUGGESTED PANEL LAYOUT

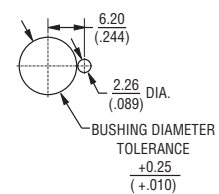

FOR TOLERANCES SHOWN: .XX = ± .25 (.010)
 .XXX = ± .13 (.005)
 SHAFT DIMENSIONS ± .80 (1/32)

DIMENSIONS: $\frac{\text{MM}}{\text{(INCHES)}}$

Specifications are subject to change without notice. The device characteristics and parameters in this data sheet can and do vary in different applications and actual device performance may vary over time. Users should verify actual device performance in their specific applications.

51/53 - Sealed 1/2" (12.5 mm) Square Control

BOURNS®

Shaft/Bushing Styles



A Style Bushing

STD. LENGTH 'L'
.500 (12.7)
.625 (15.88)
.750 (19.05)
.875 (22.23)
1.000 (25.4)

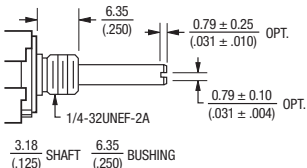

C Style Bushing

STD. LENGTH 'L'
.375 (9.53)
.500 (12.7)
.625 (15.88)
.750 (19.05)
.875 (22.23)
1.000 (25.4)



A Style Bushing - Flatted Shaft

STD. LENGTH 'L'
.625 (15.88)
.750 (19.05)
.875 (22.23)
1.000 (25.4)

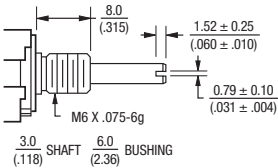

S Style Bushing

STD. LENGTH 'L'
.630 (16.0)
.866 (22.0)
.984 (25.0)

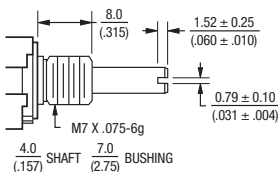

U Style Bushing

STD. LENGTH 'L'
.630 (16.0)
.866 (22.0)
.984 (25.0)

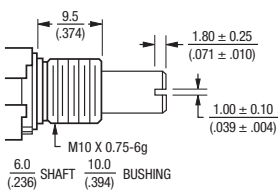

R Style Bushing

STD. LENGTH 'L'
.630 (16.0)
.866 (22.0)
.984 (25.0)

DIMENSIONS: $\frac{\text{MM}}{\text{(INCHES)}}$

How To Order

51 A A D - B 28 - A 15 / A15 L

Part number for multiple section potentiometers must have a taper and resistance value for each section.

RoHS IDENTIFIER
L Compliant

MOUNTING BRACKET/ ANTI-ROTATION LUG

Code	Description
A	AR Lug 90° CW
D	No AR Lug or Bracket
L	Front Bracket
M	Rear Bracket
N	Front and Rear Bracket

SECTIONS/DETENTS

Code	Description
A	Single No Detent
B	Double No Detent
E	Single w/Center Detent
F	Double w/Center Detent

BUSHING CONFIGURATION

Code	Description
A	3/8" D x 3/8" L
C	1/4" D x 1/4" L
R	10 mm D x 9.5 mm L
S	6 mm D x 8 mm L
U	7 mm D x 8 mm L

MODEL

Code	Description
51	PC Pins (.100" centers)
53	Solder Lugs

ELEMENT TAPER TYPE/TOLERANCE		RESISTANCE (CODE)	
Code	Description	VALUE IN OHMS	
(A)	Linear Cermet ±10 %	(28) - 150	(14) - 7.5 K
(H)	Linear Cermet ±5 %	(06) - 200	(15) - 10 K
		(07) - 250	(30) - 15 K
		(08) - 500	(16) - 20 K
		(09) - 750	(17) - 25 K
		(10) - 1 K	(18) - 50 K
		(29) - 1.5 K	(19) - 75 K
		(11) - 2 K	(20) - 100 K
		(12) - 2.5 K	(21) - 500 K
		(13) - 5 K	(25) - 1 M
(B)	Linear C-P ±20 %	(10) - 1 K	(18) - 50 K
(E)	Linear C-P ±10 %	(12) - 2.5 K	(20) - 100 K
		(13) - 5 K	(22) - 250 K
		(15) - 10 K	(23) - 500 K
		(16) - 20 K	(25) - 1 M
		(17) - 25 K	
(C)	CW Audio Cermet ±10 %	(10) - 1 K	(18) - 50 K
(F)	CCW Audio Cermet ±10 %	(12) - 2.5 K	(20) - 100 K
		(13) - 5 K	(23) - 500 K
		(15) - 10 K	(25) - 1 M
		(17) - 25 K	
(D)	CW Audio C-P ±20 %	(10) - 1 K	(18) - 50 K
(S)	CW Audio C-P ±10 %	(12) - 2.5 K	(20) - 100 K
		(13) - 5 K	(22) - 250 K
		(15) - 10 K	(23) - 500 K
		(17) - 25 K	(25) - 1 M
(G)	CCW Audio C-P ±20 %	(10) - 1 K	(18) - 50 K
(T)	CCW Audio C-P ±10 %	(12) - 2.5 K	(20) - 100 K
		(13) - 5 K	(22) - 250 K
		(15) - 10 K	(23) - 500 K
		(17) - 25 K	(25) - 1 M
(Y)	CW Dual Audio Taper C-P ±20 %	(10) - 1 K	(18) - 50 K
		(12) - 2.5 K	(20) - 100 K
		(13) - 5 K	(22) - 250 K
		(15) - 10 K	(23) - 500 K
		(17) - 25 K	(25) - 1 M

Code	SHAFT TYPE Description	AVAILABLE ONLY IN	
		BUSHINGS Code	LENGTHS Description
B	Single Slotted 1/4" D	A	24,28
C	Single Flatted 1/4" D	A	20,24,28,32
E	Single Slotted 1/8" D	C	12,16,20,24,28
R	Single Slotted 6 mm D	R	16,22,25
T	Single Slotted 4 mm D	U	16,22,25
U	Single Slotted 3 mm D	S	16,22,25

Code	SHAFT LENGTH (FMS) Description	AVAILABLE ONLY IN BUSHING Code
16	1/2"	A, C
20	5/8"	A, C
24	3/4"	A, C
28	7/8"	A, C
32	1"	A, C
Metric		
16	16 mm	R, S, U
22	22 mm	R, S, U
25	25 mm	R, S, U

Boldface features are Bourns standard options. All others are available with higher minimum order quantities.

Компания «Life Electronics» занимается поставками электронных компонентов импортного и отечественного производства от производителей и со складов крупных дистрибьюторов Европы, Америки и Азии.

С конца 2013 года компания активно расширяет линейку поставок компонентов по направлению коаксиальный кабель, кварцевые генераторы и конденсаторы (керамические, пленочные, электролитические), за счёт заключения дистрибьюторских договоров

Мы предлагаем:

- Конкурентоспособные цены и скидки постоянным клиентам.
- Специальные условия для постоянных клиентов.
- Подбор аналогов.
- Поставку компонентов в любых объемах, удовлетворяющих вашим потребностям.
- Приемлемые сроки поставки, возможна ускоренная поставка.
- Доставку товара в любую точку России и стран СНГ.
- Комплексную поставку.
- Работу по проектам и поставку образцов.
- Формирование склада под заказчика.
- Сертификаты соответствия на поставляемую продукцию (по желанию клиента).
- Тестирование поставляемой продукции.
- Поставку компонентов, требующих военную и космическую приемку.
- Входной контроль качества.
- Наличие сертификата ISO.

В составе нашей компании организован Конструкторский отдел, призванный помогать разработчикам, и инженерам.

Конструкторский отдел помогает осуществить:

- Регистрацию проекта у производителя компонентов.
- Техническую поддержку проекта.
- Защиту от снятия компонента с производства.
- Оценку стоимости проекта по компонентам.
- Изготовление тестовой платы монтаж и пусконаладочные работы.



Тел: +7 (812) 336 43 04 (многоканальный)

Email: org@lifeelectronics.ru