

# ZXMP6A18K

## 60V P-channel enhancement mode MOSFET

### Summary

$V_{(BR)DSS} = -60V$ ;  $R_{DS(on)} = 0.055$ ;  $I_D = -10.4A$

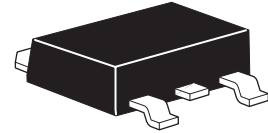

### Description

This new generation of trench MOSFETs from Zetex utilizes a unique structure that combines the benefits of low on-resistance with fast switching speed. This makes them ideal for high efficiency, low voltage, power management applications.

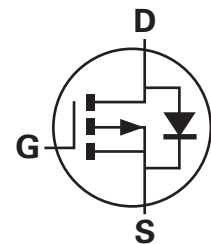

### Features

- Low on-resistance
- Fast switching speed
- Low threshold
- Low gate drive
- DPAK package

### Applications

- Motor drive
- Disconnect switches

### Ordering information

Device	Reel size (inches)	Tape width	Quantity per reel
ZXMP6A18KTC	13	16mm	2500 units

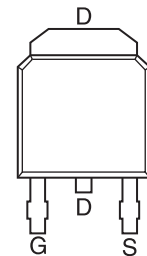

Pinout - Top view

### Device marking

ZXMP  
6A18

## Absolute maximum ratings

Parameter	Symbol	Limit	Unit
Drain-source voltage	$V_{DSS}$	-60	V
Gate-source voltage	$V_{GS}$	$\pm 20$	V
Continuous drain current @ $V_{GS}=10V$ ; $T_A=25^\circ C$ <sup>(b)</sup> @ $V_{GS}=10V$ ; $T_A=70^\circ C$ <sup>(b)</sup> @ $V_{GS}=10V$ ; $T_A=25^\circ C$ <sup>(a)</sup>	$I_D$	-10.4 -8.3 -6.8	A A A
Pulsed drain current <sup>(c)</sup>	$I_{DM}$	-37.5	A
Continuous source current (body diode) <sup>(b)</sup>	$I_S$	-11.5	A
Pulsed source current (body diode) <sup>(c)</sup>	$I_{SM}$	-37.5	A
Power dissipation at $T_A = 25^\circ C$ <sup>(a)</sup> Linear derating factor	$P_D$	4.3 34.4	W mW/ $^\circ C$
Power dissipation at $T_A = 25^\circ C$ <sup>(b)</sup> Linear derating factor	$P_D$	10.1 80.8	W mW/ $^\circ C$
Power dissipation at $T_A = 25^\circ C$ <sup>(d)</sup> Linear derating factor	$P_D$	2.15 17.2	W mW/ $^\circ C$
Operating and storage temperature range	$T_j; T_{stg}$	-55 to +150	$^\circ C$

## Thermal resistance

Parameter	Symbol	Value	Unit
Junction to ambient <sup>(a)</sup>	$R_{\theta JA}$	29	$^\circ C/W$
Junction to ambient <sup>(b)</sup>	$R_{\theta JA}$	12.3	$^\circ C/W$
Junction to ambient <sup>(d)</sup>	$R_{\theta JA}$	58	$^\circ C/W$

### NOTES:

- (a) For a device surface mounted on 50mm x 50mm x 1.6mm FR4 PCB with high coverage of single sided 2oz copper, in still air conditions.
- (b) For a device surface mounted on FR4 PCB measured at  $t = 10$  sec.
- (c) Repetitive rating 50mm x 50mm x 1.6mm FR4 PCB,  $D=0.02$  pulse width=300 s - pulse width limited by maximum junction temperature.
- (d) For a device surface mounted on 25mm x 25mm x 1.6mm FR4 PCB with high coverage of single sided 1oz copper, in still air conditions.

## Characteristics

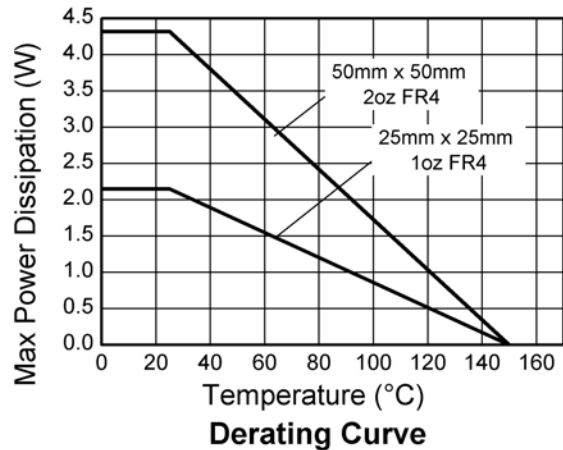
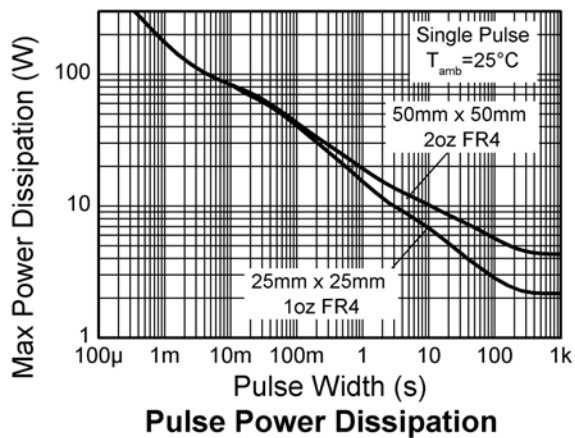
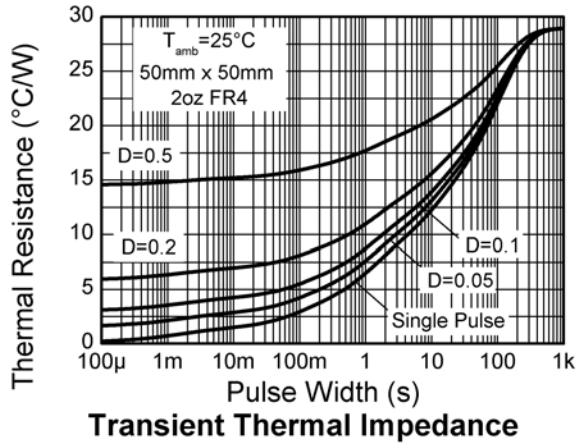
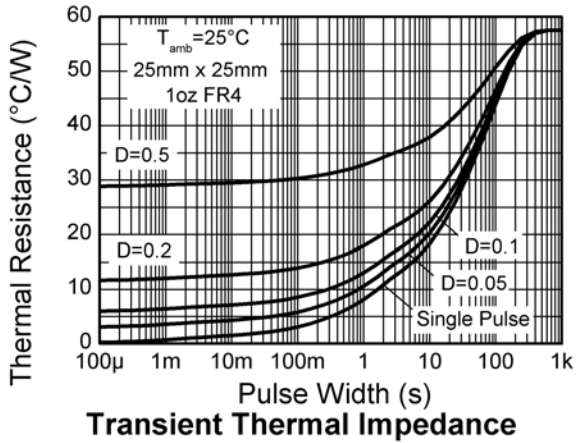
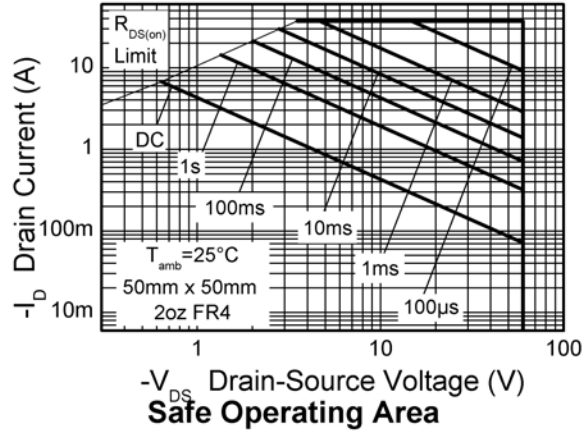
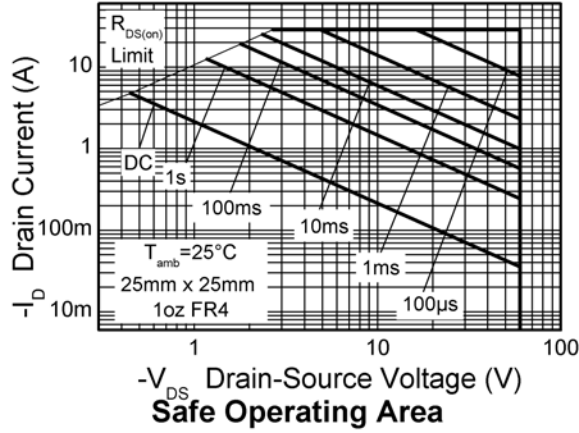

# ZXMP6A18K

## Electrical characteristics (at $T_A = 25^\circ\text{C}$ unless otherwise stated)

Parameter	Symbol	Min.	Typ.	Max.	Unit	Conditions
<b>Static</b>						
Drain-source breakdown voltage	$V_{(BR)DSS}$	-60			V	$I_D = -250\mu\text{A}$ , $V_{GS} = 0\text{V}$
Zero gate voltage drain current	$I_{DSS}$			-1.0	$\mu\text{A}$	$V_{DS} = -60\text{V}$ , $V_{GS} = 0\text{V}$
Gate-body leakage	$I_{GSS}$			100	nA	$V_{GS} = \pm 20\text{V}$ , $V_{DS} = 0\text{V}$
Gate-source threshold voltage	$V_{GS(th)}$	-1.0			V	$I_D = -250\mu\text{A}$ , $V_{DS} = V_{GS}$
Static drain-source on-state resistance (*)	$R_{DS(on)}$			0.055 0.080	$\Omega$	$V_{GS} = -10\text{V}$ , $I_D = -3.5\text{A}$ $V_{GS} = -4.5\text{V}$ , $I_D = -2.9\text{A}$
Forward transconductance (*)(‡)	gfs		8.7		S	$V_{DS} = -15\text{V}$ , $I_D = -3.5\text{A}$
<b>Dynamic (‡)</b>						
Input capacitance	$C_{iss}$		1580		pF	$V_{DS} = -30\text{V}$ , $V_{GS} = 0\text{V}$ , $f = 1\text{MHz}$
Output capacitance	$C_{oss}$		160		pF	
Reverse transfer capacitance	$C_{rss}$		140		pF	
<b>Switching (†)(‡)</b>						
Turn-on delay time	$t_{d(on)}$		4.6		ns	$V_{DD} = -30\text{V}$ , $I_D = -1\text{A}$ $R_G = 6.0\Omega$ , $V_{GS} = -10\text{V}$
Rise time	$t_r$		5.8		ns	
Turn-off delay time	$t_{d(off)}$		55		ns	
Fall time	$t_f$		23		ns	
Gate charge	$Q_g$		23		nC	$V_{DS} = -30\text{V}$ , $V_{GS} = -5\text{V}$ , $I_D = -3.5\text{A}$
Total gate charge	$Q_g$		44		nC	$V_{DS} = -30\text{V}$ , $V_{GS} = -10\text{V}$ , $I_D = -3.5\text{A}$
Gate-source charge	$Q_{gs}$		3.9		nC	
Gate-drain charge	$Q_{gd}$		9.8		nC	
<b>Source-drain diode</b>						
Diode forward voltage (*)	$V_{SD}$		-0.85	-0.95	V	$T_J = 25^\circ\text{C}$ , $I_S = -4.2\text{A}$ , $V_{GS} = 0\text{V}$
Reverse recovery time (‡)	$t_{rr}$		37		ns	$T_J = 25^\circ\text{C}$ , $I_F = -2.1\text{A}$ , $di/dt = 100\text{A}/\mu\text{s}$
Reverse recovery charge (‡)	$Q_{rr}$		56		nC	

### NOTES:

(\*) Measured under pulsed conditions. Width  $\leq 300\mu\text{s}$ . Duty cycle  $\leq 2\%$ .

(†) Switching characteristics are independent of operating junction temperature.

(‡) For design aid only, not subject to production testing.

## Typical characteristics

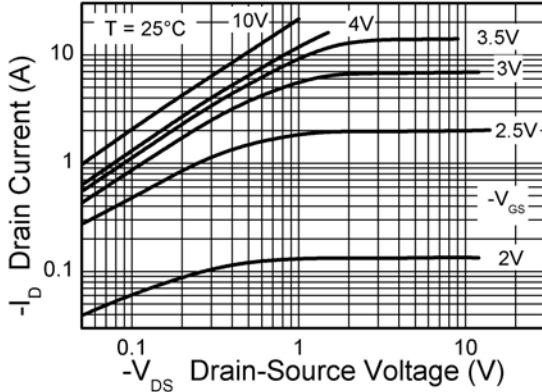

Output Characteristics

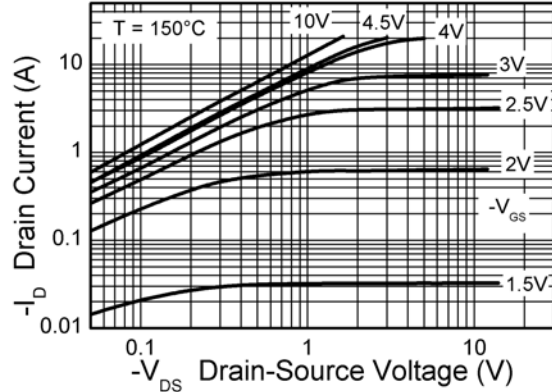

Output Characteristics

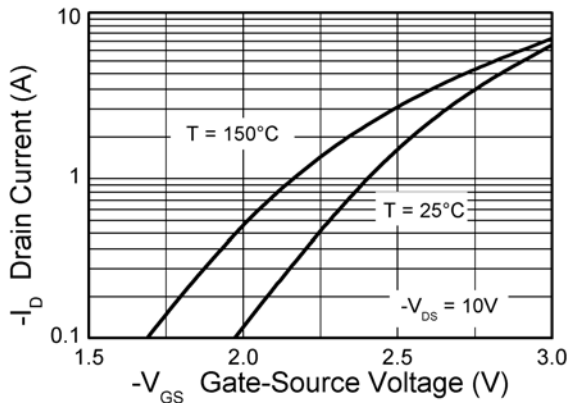

Typical Transfer Characteristics

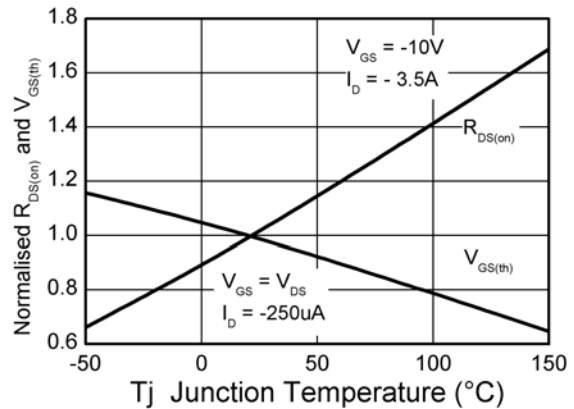

Normalised Curves v Temperature

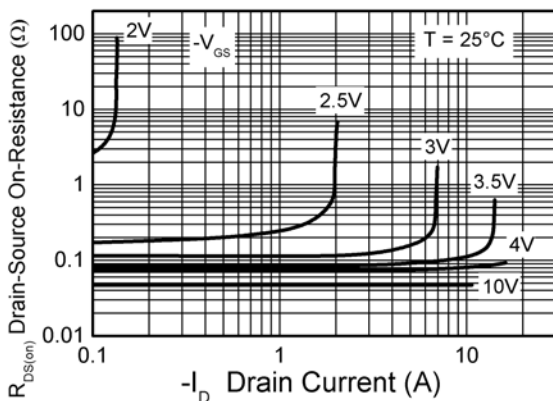

On-Resistance v Drain Current

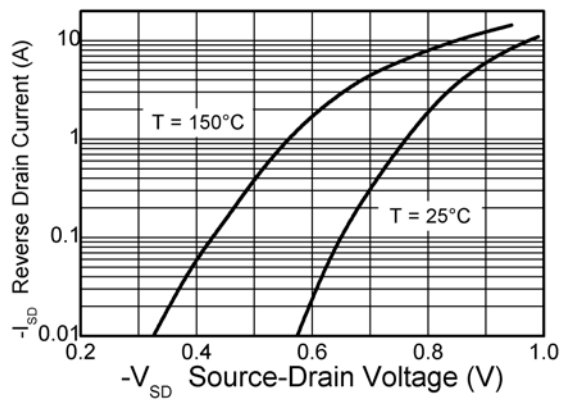

Source-Drain Diode Forward Voltage

## Typical Characteristics

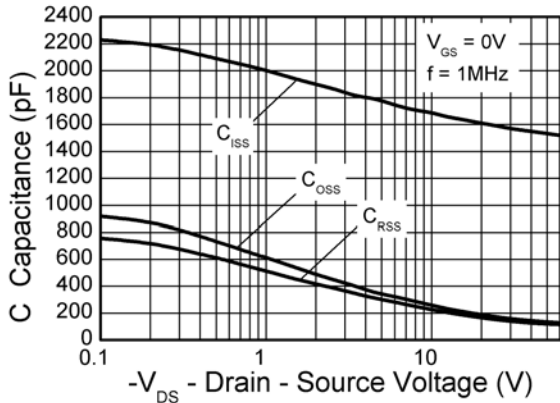

Capacitance v Drain-Source Voltage

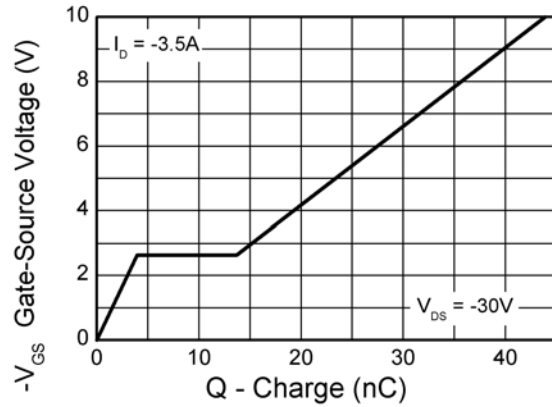

Gate-Source Voltage v Gate Charge

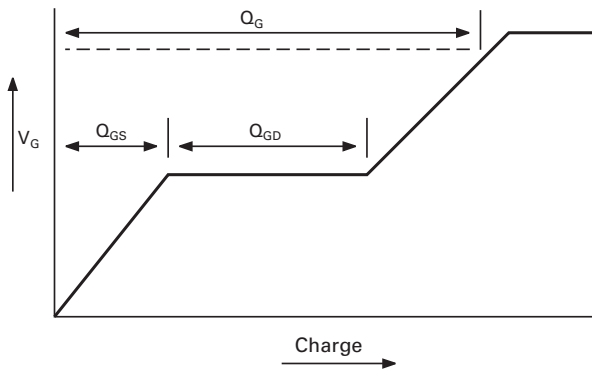

Basic gate charge waveform

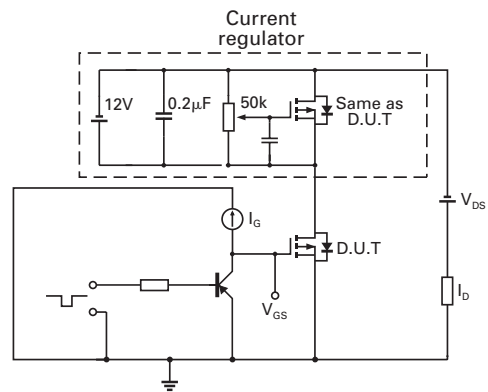

Gate charge test circuit

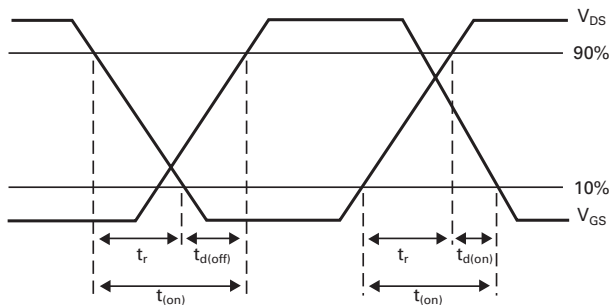

Switching time waveforms

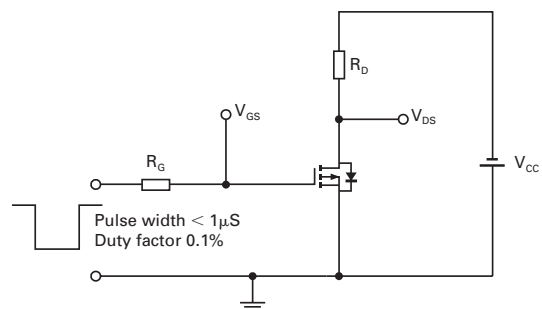

Switching time test circuit

# ZXMP6A18K

Intentionally left blank

# ZXMP6A18K

## Package outline - DPAK

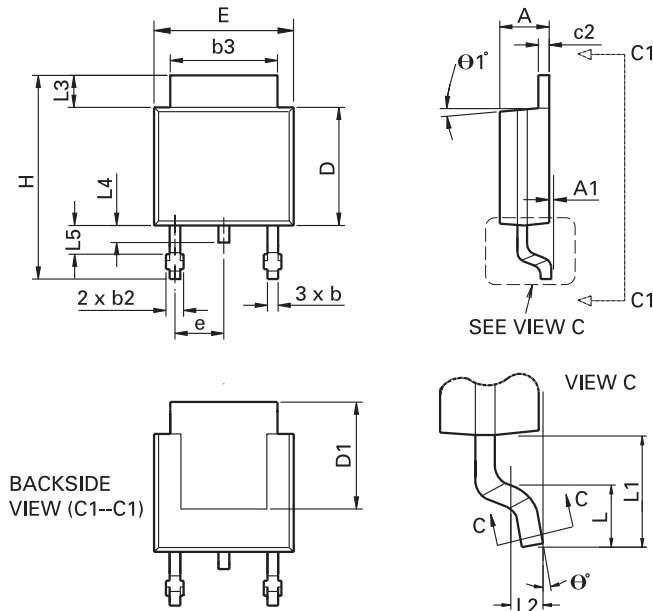

DIM	Inches		Millimeters		DIM	Inches		Millimeters	
	Min	Max	Min	Max		Min	Max	Min	Max
A	0.086	0.094	2.18	2.39	e	0.090 BSC		2.29 BSC	
A1	-	0.005	-	0.127	H	0.370	0.410	9.40	10.41
b	0.020	0.035	0.508	0.89	L	0.055	0.070	1.40	1.78
b2	0.030	0.045	0.762	1.14	L1	0.108 REF		2.74 REF	
b3	0.205	0.215	5.21	5.46	L2	0.020 BSC		0.508 BSC	
c	0.018	0.024	0.457	0.61	L3	0.035	0.065	0.89	1.65
c2	0.018	0.023	0.457	0.584	L4	0.025	0.040	0.635	1.016
D	0.213	0.245	5.41	6.22	L5	0.045	0.060	1.14	1.52
D1	0.205	-	5.21	-	theta 1°	0°	10°	0°	10°
E	0.250	0.265	6.35	6.73	theta 2°	0°	15°	0°	15°
E1	0.170	-	4.32	-	-	-	-	-	-

**Note:** Controlling dimensions are in inches. Approximate dimensions are provided in millimeters

Europe	Americas	Asia Pacific	Corporate Headquarters
Zetex GmbH Streitfeldstraße 19 D-81673 München Germany	Zetex Inc 700 Veterans Memorial Highway Hauppauge, NY 11788 USA	Zetex (Asia Ltd) 3701-04 Metroplaza Tower 1 Hing Fong Road, Kwai Fong Hong Kong	Zetex Semiconductors plc Zetex Technology Park, Chadderton Oldham, OL9 9LL United Kingdom
Telefon: (49) 89 45 49 49 0 Fax: (49) 89 45 49 49 49 europe.sales@zetex.com	Telephone: (1) 631 360 2222 Fax: (1) 631 360 8222 usa.sales@zetex.com	Telephone: (852) 26100 611 Fax: (852) 24250 494 asia.sales@zetex.com	Telephone: (44) 161 622 4444 Fax: (44) 161 622 4446 hq@zetex.com

For international sales offices visit [www.zetex.com/offices](http://www.zetex.com/offices)

Zetex products are distributed worldwide. For details, see [www.zetex.com/salesnetwork](http://www.zetex.com/salesnetwork)

This publication is issued to provide outline information only which (unless agreed by the company in writing) may not be used, applied or reproduced for any purpose or form part of any order or contact or be regarded as a representation relating to the products or services concerned. The company reserves the right to alter without notice the specification, design, price or conditions of supply of any product or service.



Компания «Life Electronics» занимается поставками электронных компонентов импортного и отечественного производства от производителей и со складов крупных дистрибьюторов Европы, Америки и Азии.

С конца 2013 года компания активно расширяет линейку поставок компонентов по направлению коаксиальный кабель, кварцевые генераторы и конденсаторы (керамические, пленочные, электролитические), за счёт заключения дистрибьюторских договоров

Мы предлагаем:

- Конкуренеспособные цены и скидки постоянным клиентам.
- Специальные условия для постоянных клиентов.
- Подбор аналогов.
- Поставку компонентов в любых объемах, удовлетворяющих вашим потребностям.
- Приемлемые сроки поставки, возможна ускоренная поставка.
- Доставку товара в любую точку России и стран СНГ.
- Комплексную поставку.
- Работу по проектам и поставку образцов.
- Формирование склада под заказчика.
- Сертификаты соответствия на поставляемую продукцию (по желанию клиента).
- Тестирование поставляемой продукции.
- Поставку компонентов, требующих военную и космическую приемку.
- Входной контроль качества.
- Наличие сертификата ISO.

В составе нашей компании организован Конструкторский отдел, призванный помогать разработчикам, и инженерам.

Конструкторский отдел помогает осуществить:

- Регистрацию проекта у производителя компонентов.
- Техническую поддержку проекта.
- Защиту от снятия компонента с производства.
- Оценку стоимости проекта по компонентам.
- Изготовление тестовой платы монтаж и пусконаладочные работы.



Тел: +7 (812) 336 43 04 (многоканальный)

Email: [org@lifeelectronics.ru](mailto:org@lifeelectronics.ru)