

NTC SMD Thermistors



NB 21 (Ni Barrier/100% Sn Termination)

Chip thermistors are high quality and low cost devices especially developed for surface mounting applications. They are widely used for temperature compensation but can also achieve temperature control of printed circuits.

A nickel barrier metallization provides outstanding qualities of solderability and enables this chip to meet the requirements of the most severe soldering processes including lead free soldering with peak temperatures up to 270°C.

Types	NB 21 IEC SIZE : 0603
DIMENSIONS: millimeters (inches)	
Terminations	Nickel Barrier/100% Tin
Marking	On packaging only
Climatic category	40/125/56
Operating temperature	-55°C to +150°C
Tolerance on R _n (25°C)	±3%*, ±5%, ±10%, ±20%
Maximum dissipation at 25°C	0.07 W
Thermal dissipation factor	1 mW/°C
Thermal time constant	4 s

Resistance - Temperature characteristics: pages 29 to 33.

FEATURES

- Fast thermal response
- Commercial, Industrial and Automotive Applications
- Ni Barrier/100% Sn Termination
- Suitable for lead free reflow or wave soldering
- AEC-Q200 based qualification

APPLICATIONS

- LCD compensation
- Battery packs
- Mobile phones
- CD players
- Heating systems
- Air-conditioning systems
- Refrigeration
- Temperature control of Switch Mode Power Supplies
- Compensation of pressure sensors
- Protection of power transistors in various electronic circuits and more



HOW TO ORDER

NB 21	K 0	0103	M	BB
Type NB21 (0603)	Material Code K (See tables pages 11)	Resistance 10,000 Ω (See tables page 11)	Tolerance H (±3%)* J (±5%) K (±10%) M (±20%)	Suffix: Packaging --: Bulk (5000 pcs/bag) BB: Cardboard tape (180mm diam. reel, 4000 pcs/reel) BF: Cardboard tape (1/2 reel, 2000 pcs/reel) BD: Cardboard tape (330mm diam. reel, 10,000 pcs/reel)

* Optional tolerance, please contact factory

NTC SMD Thermistors

NB 21 (Ni Barrier/100% Sn Termination)



TABLE OF VALUES

NB 21 IEC SIZE : 0603				
Types	Rn at 25°C (Ω)	Material Code	B (K) ($\Delta B/B$ (1) ± 5% (2) ± 3%)	α at 25°C (%/°C)
NB 21 KC 0 470 NB 21 KC 0 101 NB 21 KC 0 471	47 100 470	KC	3470 ± 5%	- 3.9
NB 21 MC 0 102	1,000	MC	3910 ± 3%	- 4.4
NB 21 J 0 0472 NB 21 J 0 0502	4,700 5,000	J	3480 ± 3%	- 3.9
NB 21 J 5 0682 NB 21 J 5 0103	6,800 10,000	J5	3480 ± 3%	- 3.9
NB 21 K 0 0103 NB 21 K 0 0153	10,000 15,000	K	3630 ± 3%	- 4.0
NB 21 L 0 0223	22,000	L	3790 ± 3%	- 4.2
NB 21 M 0 0333 NB 21 M 0 0473	33,000 47,000	M	3950 ± 3%	- 4.4
NB 21 M4 0 503	50,000	M4	4000 ± 3%	- 4.4
NB 21 L 2 0683	68,000	L2	3805 ± 3%	- 4.1
NB 21 N 0 0683	68,000	N	4080 ± 3%	- 4.6
NB 21 N 5 0104	100,000	N5	4160 ± 3%	- 4.7
NB 21 P 0 0154	150,000	P	4220 ± 3%	- 4.7
NB 21 Q 0 0334 NB 21 Q 0 0474	330,000 470,000	Q	4300 ± 3%	- 4.7

NTC SMD Thermistors

NB 12 - NB 20 (Ni Barrier/100% Sn Termination)



Chip thermistors are high quality and low cost devices especially developed for surface mounting applications. They are widely used for temperature compensation but can also achieve temperature control of printed circuits.

A nickel barrier metallization provides outstanding qualities of solderability and enables this chip to meet the requirements of the most severe soldering processes including lead free soldering with peak temperatures up to 270°C.

Types	NB 12 IEC SIZE : 0805	NB 20 IEC SIZE : 1206
DIMENSIONS: millimeters (inches)		
Terminations	Nickel Barrier/100% Tin	
Marking	On packaging only	
Climatic category	40/125/56	
Operating temperature	-55°C to +150°C	
Tolerance on R _n (25°C)	±3%*, ±5%, ±10%, ±20%	
Maximum dissipation at 25°C	0.12 W	0.24 W
Thermal dissipation factor	2 mW/°C	4 mW/°C
Thermal time constant	5 s	7s

Resistance - Temperature characteristics: pages 29 to 33.

FEATURES

- Fast thermal response
- Commercial, Industrial and Automotive Applications
- Ni Barrier/100% Sn Termination
- Suitable for lead free reflow or wave soldering
- AEC-Q200 based qualification

APPLICATIONS

- LCD compensation
- Battery packs
- Mobile phones
- CD players
- Heating systems
- Air-conditioning systems
- Refrigeration
- Temperature control of Switch Mode Power Supplies
- Compensation of pressure sensors
- Protection of power transistors in various electronic circuits and more



HOW TO ORDER

NB 20
Type
NB12 (0805)
NB20 (1206)

K 0
Material Code
K
(See tables pages 13)

0103
Resistance
10,000 Ω
(See tables page 13)

M
Tolerance
H (±3%)*
J (±5%)
K (±10%)
M (±20%)

BA
Suffix: Packaging
-- : Bulk (5000 pcs/bag)
NB20 BA: Plastic tape (180mm diam. reel, 3000 pcs/reel)
BE: Plastic tape (1/2 reel, 1500 pcs/reel)
BC: Plastic tape (330mm diam. reel, 10,000 pcs/reel)
NB12 BB: Cardboard tape (180mm diam. reel, 4000 pcs/reel)
BF: Cardboard tape (1/2 reel, 2000 pcs/reel)
BD: Cardboard tape (330mm diam. reel, 10,000 pcs/reel)

* Optional tolerance, please contact factory

NTC SMD Thermistors

NB 12 - NB 20 (Ni Barrier/100% Sn Termination)



TABLE OF VALUES

NB 12 IEC SIZE : 0805				
Types	Rn at 25°C (Ω)	Material Code	B (K) ($\Delta B/B$ (1) $\pm 5\%$ (2) $\pm 3\%$)	α at 25°C (%/°C)
NB 12 KC 0 180	18	KC	3470 \pm 5%	- 3.9
NB 12 KC 0 220	22			
NB 12 KC 0 270	27			
NB 12 KC 0 330	33			
NB 12 KC 0 390	39			
NB 12 KC 0 470	47			
NB 12 KC 0 560	56			
NB 12 KC 0 680	68			
NB 12 KC 0 820	82			
NB 12 KC 0 101	100			
NB 12 MC 0 121	120	MC	3910 \pm 3%	- 4.4
NB 12 MC 0 151	150			
NB 12 MC 0 181	180			
NB 12 MC 0 221	220			
NB 12 MC 0 271	270			
NB 12 MC 0 331	330			
NB 12 MC 0 391	390			
NB 12 MC 0 471	470			
NB 12 MC 0 561	560			
NB 12 MC 0 681	680			
NB 12 MC 0 821	820			
NB 12 MC 0 102	1,000			
NB 12 MC 0 122	1,200			
NB 12 MC 0 152	1,500			
NB 12 MC 0 182	1,800			
NB 12 MC 0 222	2,200			
NB 12 MC 0 272	2,700			
NB 12 MC 0 332	3,300			
NB 12 J 0 0332	3,300	J	3480 \pm 3%	- 3.9
NB 12 J 0 0392	3,900			
NB 12 J 0 0472	4,700			
NB 12 J 0 0502	5,000			
NB 12 J 0 0562	5,600			
NB 12 K 0 0682	6,800	K	3630 \pm 3%	- 4.0
NB 12 K 0 0822	8,200			
NB 12 K 0 0103	10,000			
NB 12 K 0 0123	12,000			
NB 12 L 0 0153	15,000			
NB 12 L 0 0183	18,000			
NB 12 M 0 0223	22,000	M	3950 \pm 3%	- 4.4
NB 12 M 0 0273	27,000			
NB 12 M 0 0333	33,000			
NB 12 M 0 0393	39,000			
NB 12 N 0 0473	47,000	N	4080 \pm 3%	- 4.6
NB 12 N 0 0503	50,000			
NB 12 N 0 0563	56,000			
NB 12 L 2 0683	68,000	L2	3805 \pm 3%	- 4.1
NB 12 N 0 0823	82,000	N	4080 \pm 3%	- 4.6
NB 12 P 0 0104	100,000	P	4220 \pm 3%	- 4.7
NB 12 P 0 0124	120,000			
NB 12 P 0 0154	150,000			
NB 12 P 0 0184	180,000			
NB 12 Q 0 0224	220,000	Q	4300 \pm 3%	-4.7

NB 20 IEC SIZE : 1206				
Types	Rn at 25°C (Ω)	Material Code	B (K) ($\Delta B/B$ (1) $\pm 5\%$ (2) $\pm 3\%$)	α at 25°C (%/°C)
NB 20 MC 0 221	220	MC	3910 \pm 3%	- 4.4
NB 20 MC 0 102	1,000	M C	3910 \pm 3%	- 4.4
NB 20 J 0 0472	4,700	J	3480 \pm 3%	- 3.9
NB 20 J 0 0502	5,000			
NB 20 J 0 0562	5,600			
NB 20 J 0 0682	6,800			
NB 20 J 5 0822	8,200	J5	3480 \pm 3%	- 3.9
NB 20 K 0 0103	10,000	K	3630 \pm 3%	- 4.0
NB 20 K 0 0123	12,000			
NB 20 L 0 0153	15,000	L	3790 \pm 3%	- 4.2
NB 20 L 0 0183	18,000			
NB 20 L 0 0223	22,000			
NB 20 M 0 0273	27,000	M	3950 \pm 3%	- 4.4
NB 20 M 0 0333	33,000			
NB 20 M 0 0393	39,000			
NB 20 M 0 0473	47,000			
NB 20 M 4 0503	50,000	M4	4000 \pm 3%	- 4.4
NB 20 N 0 0563	56,000	N	4080 \pm 3%	- 4.6
NB 20 N 0 0683	68,000			
NB 20 N 0 0823	82,000			
NB 20 N 5 0104	100,000	N5	4160 \pm 3%	- 4.7
NB 20 P 0 0124	120,000	P	4220 \pm 3%	- 4.7
NB 20 P 0 0154	150,000			
NB 20 P 0 0184	180,000			
NB 20 P 0 0224	220,000			
NB 20 Q 0 0274	270,000	Q	4300 \pm 3%	- 4.7
NB 20 Q 0 0334	330,000			
NB 20 Q 0 0394	390,000			
NB 20 Q 0 0474	470,000			
NB 20 Q 0 0564	560,000	R	4400 \pm 3%	- 4.8
NB 20 R 0 0684	680,000			
NB 20 R 0 0824	820,000			
NB 20 R 0 0105	1,000,000			

Packaging for Automatic Insertion

NTC Chip Thermistors / NC/NB Series



AUTOMATIC INSERTION

Super 8 Plastic Tape Packaging:

The mechanical and dimensional reel characteristics are in accordance with the IEC publication 286-3.



Designation	Symbol	Value	Tolerance	
Tape width	W	8	±0.2	
Tape thickness	T	0.4 max.		
Pitch of the sprocket holes	P0	4	±0.1	
Diameter of the sprocket holes	D0	1.5 -0	±0.1	
Distance	E	1.75	±0.1	
Distance (center to center)	F	3.5	±0.05	
Distance (center to center)	P2	2	±0.1	
Sizes of the cavities	NC 12 (0805)	A0	1.5	±0.1
		B0	2.4	±0.1
		K	1.4 max.	K ±0.1 (size is adjustable) (K = t1 +0.2)
	NC 20 (1206)	A0	1.95	±0.1
		B0	3.55	±0.1
		K	1.5 max.	K ±0.1 (size is adjustable) (K = t1 +0.2)

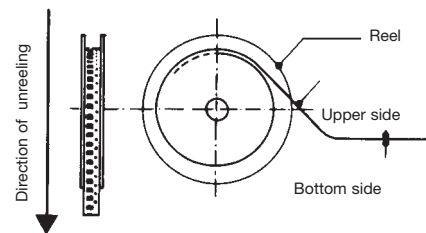

QUANTITY PER REEL

Type	Suffix	Description	Qty Per Reel
NB20 NC20	BA	Plastic tape (180mm diam. reel)	3,000 pcs
	BE	Plastic tape (1/2 reel)	1,500 pcs
	BC	Plastic tape (330mm diam. reel)	10,000 pcs

Packaging for Automatic Insertion

NTC Chip Thermistors / NC/NB Series



AUTOMATIC INSERTION

8mm Paper Tape Packaging:

The mechanical and dimensional reel characteristics are in accordance with the IEC publication 286-3.

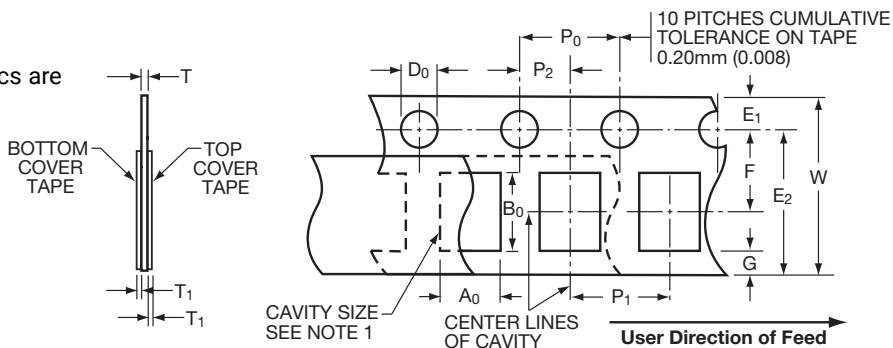

Designation	Symbol	Value	Tolerance
Tape width	W	8	$-.0.1/+0.3$
Tape thickness	T	1.1 max.	
Pitch of the sprocket holes	P_0	4	± 0.1
Diameter of the sprocket holes	D_0	1.5	± 0.1
Distance	E_1	1.75	± 0.1
Distance (center to center)	F	3.5	± 0.05
Distance (center to center)	P_2	2	± 0.05
Cover tape thickness	T_1	0.10 max.	
Distance	E_2	6.25 min.	
Distance	G	0.75 min.	
Component pitch	P_1	0805/0603	± 0.1
		0402	± 0.1

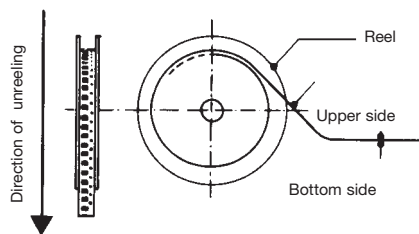

QUANTITY PER REEL

Type	Suffix	Description	Qty Per Reel
NB12	BB	Cardboard tape (180mm diam. reel)	4,000 pcs
NC12	BF	Cardboard tape (1/2 reel)	2,000 pcs
NB21	BD	Cardboard tape (330mm diam. reel)	10,000 pcs
NC21			

Surface Mounting Guide

Chip Thermistor – Application Notes



STORAGE

Good solderability is maintained for at least twelve months, provided the components are stored in their “as received” packaging at less than 40°C and 70% RH.

SOLDERABILITY / LEACHING

Terminations to be well soldered after immersion in a 60/40 tin/lead solder bath at $235 \pm 5^\circ\text{C}$ for 2 ± 1 seconds.

Terminations will resist leaching for at least the immersion times and conditions recommendations shown below.

P/N	Termination Type	Solder Tin/Lead	Solder Temp °C	Immersion Time Seconds
NC	AgPdPt	60/40	260 ± 5	15 max
NB	Nickel Barrier	60/40	260 ± 5	30 ± 1

NB products are compatible with a wide range of soldering conditions consistent with good manufacturing practice for surface mount components. This includes Pb free reflow processes with peak temperatures up to 270°C . Recommended profiles for reflow and wave soldering are shown below for reference.

NC products are recommended for lead soldering application or gluing techniques.

Wave

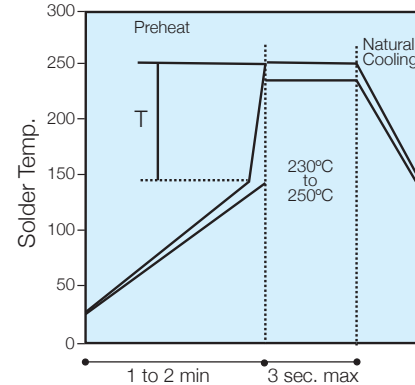

(Preheat chips before soldering)
T/maximum 150°C

- The visual standards used for evaluation of solder joints will need to be modified as lead free joints are not as bright as with tin-lead pastes and the fillet may not be as large.
- Resin color may darken slightly due to the increase in temperature required for the new pastes.
- Lead-free solder pastes do not allow the same self alignment as lead containing systems. Standard mounting pads are acceptable, but machine set up may need to be modified.

Reflow

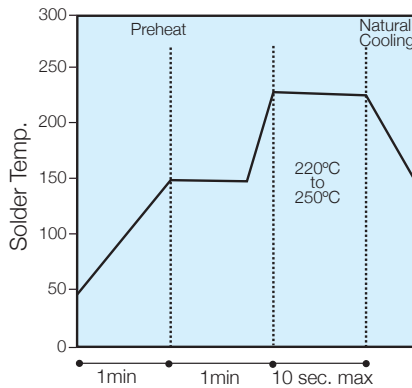

(Minimize soldering time)

RECOMMENDED SOLDERING PAD LAYOUT

Dimensions in mm (inches)

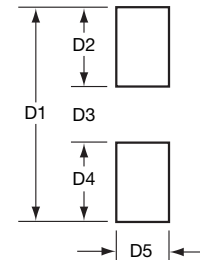

REFLOW SOLDERING

Case Size	P/N	D1	D2	D3	D4	D5
0603	NB21	2.30 (.091)	0.80 (.031)	0.70 (.028)	0.80 (.031)	0.75 (.030)
0805	NB12	3.00 (.118)	1.00 (.039)	1.00 (.039)	1.00 (.039)	1.25 (.049)
1206	NB20	4.00 (.157)	1.00 (.039)	2.00 (.079)	1.00 (.039)	2.50 (.098)

WAVE SOLDERING

Case Size	P/N	D1	D2	D3	D4	D5
0603	NB21	3.10 (.122)	1.20 (.047)	0.70 (.028)	1.20 (.047)	0.75 (.030)
0805	NB12	4.00 (.157)	1.50 (.059)	1.00 (.039)	1.50 (.059)	1.25 (.049)
1206	NB20	5.00 (.197)	1.50 (.059)	2.00 (.079)	1.50 (.059)	1.60 (.063)

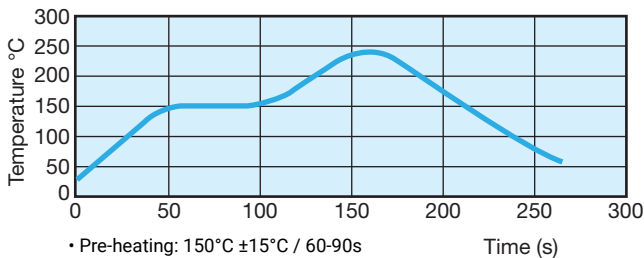

- Pre-heating: $150^\circ\text{C} \pm 15^\circ\text{C} / 60-90\text{s}$
- Max. Peak Gradient: 2.5°C/s
- Peak Temperature: $245^\circ\text{C} \pm 5^\circ\text{C}$
- Time at $>230^\circ\text{C}$: 40s Max.

Tables of Resistance vs Temperature



T (°C)	Material B(K)		
	RC 4340		
	R(T) / R25	TF (%)	α (%/°C)
-55	105.70	25.5	-7.15
-50	74.01	22.1	-6.95
-45	52.37	19.0	-6.75
-40	37.43	16.2	-6.56
-35	27.01	13.8	-6.38
-30	19.66	11.6	-6.20
-25	14.44	9.7	-6.04
-20	10.70	8.0	-5.87
-15	7.990	6.5	-5.72
-10	6.013	5.2	-5.57
-5	4.559	4.1	-5.42
0	3.482	3.1	-5.29
5	2.678	2.2	-5.15
10	2.074	1.5	-5.02
15	1.616	0.9	-4.90
20	1.267	0.4	-4.77
25	1.0000	0.0	-4.66
30	0.7936	0.4	-4.54
35	0.6334	0.8	-4.43
40	0.5083	1.3	-4.33
45	0.4100	1.9	-4.23
50	0.3325	2.5	-4.13
55	0.2709	3.1	-4.03
60	0.2218	3.7	-3.94
65	0.1825	4.4	-3.85
70	0.1508	5.1	-3.76
75	0.1251	5.8	-3.67
80	0.1043	6.6	-3.59
85	0.08727	7.3	-3.51
90	0.07332	8.1	-3.43
95	0.06184	8.9	-3.36
100	0.05235	9.7	-3.29
105	0.04448	10.5	-3.22
110	0.03793	11.3	-3.15
115	0.03245	12.1	-3.08
120	0.02785	12.9	-3.01
125	0.02399	13.7	-2.95
130	0.02072	14.5	-2.89
135	0.01796	15.4	-2.83
140	0.01561	16.2	-2.77
145	0.01360	17.0	-2.72
150	0.01189	17.8	-2.66

T (°C)	Material B(K)		
	T 4630		
	R(T) / R25	TF (%)	α (%/°C)
-55	137.10	27.2	-7.33
-50	94.94	23.5	-7.15
-45	66.35	20.2	-6.98
-40	46.78	17.3	-6.82
-35	33.25	14.7	-6.66
-30	23.84	12.4	-6.50
-25	17.23	10.3	-6.35
-20	12.54	8.5	-6.20
-15	9.206	6.9	-6.05
-10	6.807	5.6	-5.91
-5	5.070	4.3	-5.77
0	3.803	3.3	-5.63
5	2.873	2.4	-5.50
10	2.185	1.6	-5.36
15	1.673	1.0	-5.23
20	1.289	0.4	-5.11
25	1.0000	0.0	-4.99
30	0.7805	0.4	-4.86
35	0.6129	0.9	-4.75
40	0.4841	1.4	-4.63
45	0.3847	2.0	-4.52
50	0.3074	2.6	-4.41
55	0.2470	3.3	-4.30
60	0.1996	4.0	-4.19
65	0.1621	4.7	-4.09
70	0.1323	5.4	-3.99
75	0.1086	6.2	-3.89
80	0.08951	7.0	-3.80
85	0.07416	7.8	-3.71
90	0.06172	8.6	-3.62
95	0.05160	9.5	-3.53
100	0.04333	10.3	-3.44
105	0.03655	11.2	-3.36
110	0.03095	12.0	-3.28
115	0.02632	12.9	-3.20
120	0.02246	13.7	-3.12
125	0.01925	14.6	-3.05
130	0.01656	15.5	-2.97
135	0.01429	16.4	-2.90
140	0.01238	17.3	-2.83
145	0.01076	18.1	-2.77
150	0.009383	19.0	-2.70

T (°C)	Material B(K)		
	U 4840		
	R(T) / R25	TF (%)	α (%/°C)
-55	173.70	28.5	-7.69
-50	118.20	24.6	-7.50
-45	81.18	21.2	-7.32
-40	56.26	18.1	-7.15
-35	39.34	15.4	-6.98
-30	27.75	12.9	-6.82
-25	19.74	10.8	-6.66
-20	14.15	8.9	-6.50
-15	10.23	7.3	-6.34
-10	7.457	5.8	-6.19
-5	5.476	4.5	-6.04
0	4.051	3.4	-5.90
5	3.020	2.5	-5.76
10	2.267	1.7	-5.62
15	1.714	1.0	-5.48
20	1.305	0.5	-5.35
25	1.0000	0.0	-5.22
30	0.7715	0.4	-5.09
35	0.5991	0.9	-4.97
40	0.4681	1.5	-4.84
45	0.3680	2.1	-4.72
50	0.2911	2.8	-4.61
55	0.2316	3.4	-4.49
60	0.1853	4.2	-4.38
65	0.1491	4.9	-4.28
70	0.1206	5.7	-4.17
75	0.09812	6.5	-4.07
80	0.08022	7.3	-3.97
85	0.06591	8.2	-3.87
90	0.05442	9.0	-3.77
95	0.04515	9.9	-3.68
100	0.03763	10.8	-3.59
105	0.03150	11.7	-3.50
110	0.02649	12.6	-3.42
115	0.02237	13.5	-3.33
120	0.01897	14.4	-3.25
125	0.01615	15.3	-3.17
130	0.01380	16.2	-3.10
135	0.01184	17.1	-3.02
140	0.01020	18.0	-2.95
145	0.008814	19.0	-2.88
150	0.007643	19.9	-2.81

T (°C)	Material B(K)		
	S 4520		
	R(T) / R25	TF (%)	α (%/°C)
-55	126.10	26.6	-7.25
-50	87.75	23.0	-7.07
-45	61.60	19.8	-6.90
-40	43.63	16.9	-6.73
-35	31.17	14.3	-6.56
-30	22.46	12.1	-6.40
-25	16.31	10.1	-6.25
-20	11.94	8.3	-6.10
-15	8.809	6.8	-5.95
-10	6.549	5.4	-5.80
-5	4.904	4.2	-5.66
0	3.699	3.2	-5.52
5	2.810	2.3	-5.39
10	2.149	1.6	-5.26
15	1.654	1.0	-5.13
20	1.282	0.4	-5.00
25	1.0000	0.0	-4.88
30	0.7848	0.4	-4.76
35	0.6196	0.9	-4.64
40	0.4921	1.4	-4.52
45	0.3931	2.0	-4.41
50	0.3158	2.6	-4.30
55	0.2551	3.2	-4.20
60	0.2072	3.9	-4.09
65	0.1691	4.6	-3.99
70	0.1387	5.3	-3.89
75	0.1144	6.1	-3.80
80	0.0948	6.8	-3.71
85	0.0789	7.6	-3.61
90	0.06594	8.4	-3.53
95	0.05538	9.2	-3.44
100	0.04671	10.1	-3.36
105	0.03956	10.9	-3.28
110	0.03364	11.7	-3.20
115	0.02872	12.6	-3.12
120	0.02461	13.4	-3.04
125	0.02117	14.3	-2.97
130	0.01827	15.1	-2.90
135	0.01583	16.0	-2.83
140	0.01376	16.8	-2.77
145	0.01200	17.7	-2.70
150	0.01050	18.6	-2.64

T (°C)	Material B(K)		
	SC 4500		
	R(T) / R25	TF (%)	α (%/°C)
-55	129.80	26.5	-7.51
-50	89.31	22.9	-7.29
-45	62.15	19.7	-7.07
-40	43.72	16.8	-6.87
-35	31.07	14.3	-6.68
-30	22.29	12.0	-6.49
-25	16.15	10.0	-6.31
-20	11.80	8.3	-6.14
-15	8.703	6.8	-5.97
-10	6.470	5.4	-5.81
-5	4.849	4.2	-5.66
0	3.662	3.2	-5.51
5	2.786	2.3	-5.36
10	2.135	1.6	-5.23
15	1.647	0.9	-5.09
20	1.279	0.4	-4.96
25	1.0000	0.0	-4.84
30	0.7865	0.4	-4.72
35	0.6223	0.9	-4.60
40	0.4953	1.4	-4.49
45	0.3963	2.0	-4.38
50	0.3189	2.6	-4.28
55	0.2579	3.2	-4.18
60	0.2096	3.9	-4.08
65	0.1712	4.6	-3.99
70	0.1405	5.3	-3.89
75	0.1159	6.0	-3.80
80	0.09595	6.8	-3.72
85	0.07980	7.6	-3.63
90	0.06664	8.4	-3.55
95	0.05588	9.2	-3.47
100	0.04704	10.0	-3.40
105	0.03975	10.8	-3.32
110	0.03371	11.7	-3.25
115	0.02869	12.5	-3.18
120	0.02450	13.4	-3.12
125	0.02100	14.2	-3.05
130	0.01805	15.1	-2.99
135	0.01557	15.9	-2.92
140	0.01347	16.8	-2.86
145	0.01169	17.6	-2.80
150	0.01017	18.5	-2.75

Компания «Life Electronics» занимается поставками электронных компонентов импортного и отечественного производства от производителей и со складов крупных дистрибьюторов Европы, Америки и Азии.

С конца 2013 года компания активно расширяет линейку поставок компонентов по направлению коаксиальный кабель, кварцевые генераторы и конденсаторы (керамические, пленочные, электролитические), за счёт заключения дистрибьюторских договоров

Мы предлагаем:

- Конкурентоспособные цены и скидки постоянным клиентам.
- Специальные условия для постоянных клиентов.
- Подбор аналогов.
- Поставку компонентов в любых объемах, удовлетворяющих вашим потребностям.
- Приемлемые сроки поставки, возможна ускоренная поставка.
- Доставку товара в любую точку России и стран СНГ.
- Комплексную поставку.
- Работу по проектам и поставку образцов.
- Формирование склада под заказчика.
- Сертификаты соответствия на поставляемую продукцию (по желанию клиента).
- Тестирование поставляемой продукции.
- Поставку компонентов, требующих военную и космическую приемку.
- Входной контроль качества.
- Наличие сертификата ISO.

В составе нашей компании организован Конструкторский отдел, призванный помогать разработчикам, и инженерам.

Конструкторский отдел помогает осуществить:

- Регистрацию проекта у производителя компонентов.
- Техническую поддержку проекта.
- Защиту от снятия компонента с производства.
- Оценку стоимости проекта по компонентам.
- Изготовление тестовой платы монтаж и пусконаладочные работы.



Тел: +7 (812) 336 43 04 (многоканальный)

Email: org@lifeelectronics.ru