

HDSM-531x/533x

0.56" (14.22mm) Single digit surface mount LED display



Data Sheet

Description

This is 0.56" (14.22mm) height single digit display. This device utilizes AlInGaP / GaAs chip. This device is with top surface gray and white segments.

Features

- 0.56" digit height
- Low current operation
- Excellent characters appearance
- Available in CA and CC
- 1000 pieces per reel
- Moisture Sensitivity Level: Level 3
- RoHS compliant

Ordering Information

Red	Green	Yellow	Orange	Description
HDSM-531C	HDSM-531H	HDSM-531F	HDSM-531L	Common Anode, Right Hand Decimal
HDSM-533C	HDSM-533H	HDSM-533F	HDSM-533L	Common Cathode, Right Hand Decimal

Package Dimensions

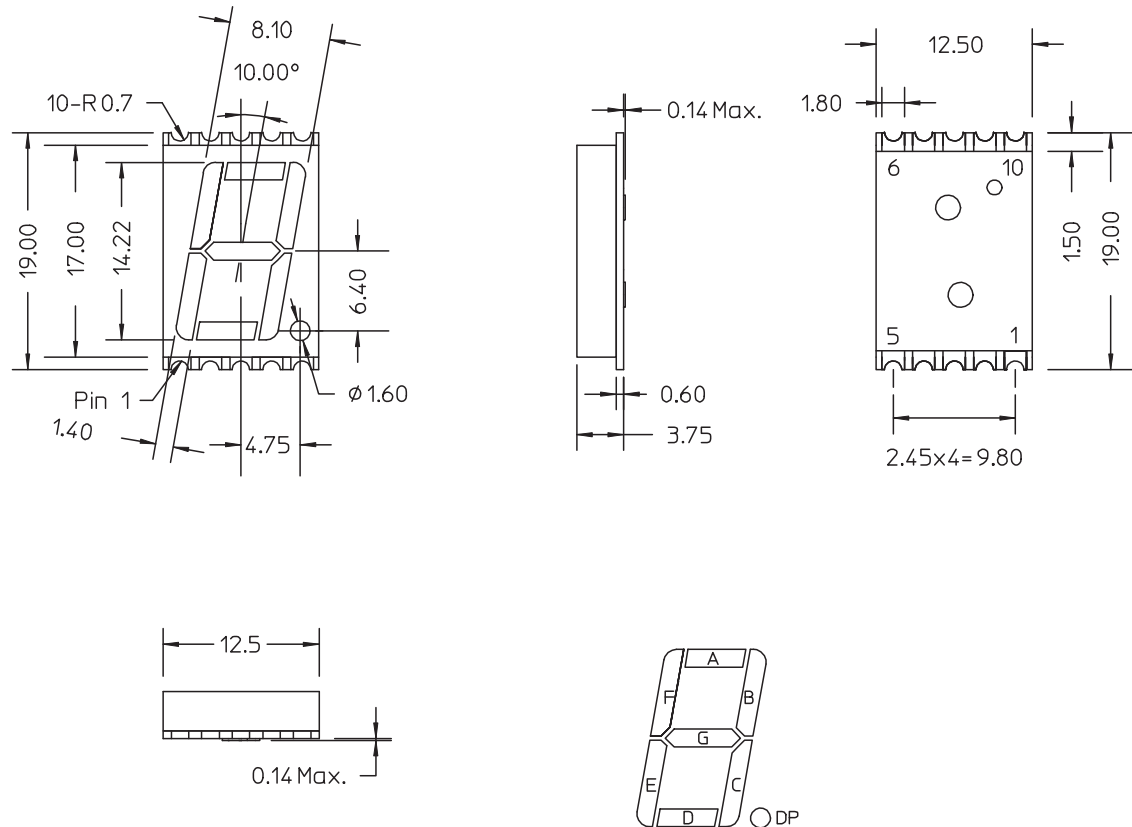

Notes:
 All dimensions are in millimeters (inches).
 Tolerance: $\pm 0.25\text{mm}$ (0.01") unless otherwise noted.

Pin Connection (Common Anode)

PIN No	Connection
1	Cathode E
2	Cathode D
3	Common Anode
4	Cathode C
5	Cathode DP
6	Cathode B
7	Cathode A
8	Common Anode
9	Cathode F
10	Cathode G

Pin Connection (Common Cathode)

PIN No	Connection
1	Anode E
2	Anode D
3	Common Cathode
4	Anode C
5	Anode DP
6	Anode B
7	Anode A
8	Common Cathode
9	Anode F
10	Anode G

Internal Circuit Diagram (Common Anode)

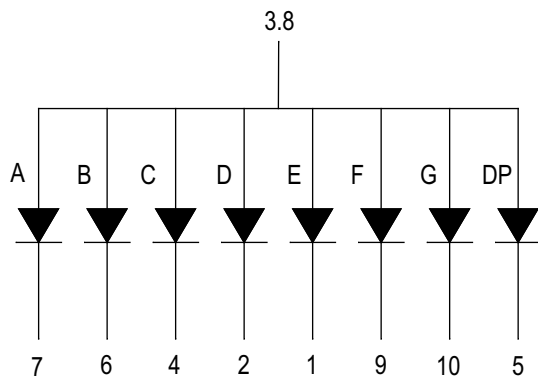

Internal Circuit Diagram (Common Cathode)

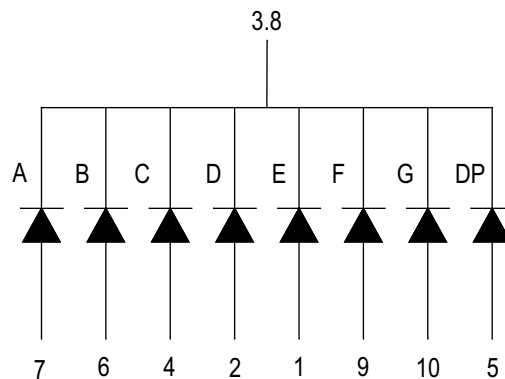

Absolute Maximum Ratings @ $T_A=25^\circ$

Parameter	Green/Yellow/Red/Orange	Unit
Power Dissipation Per Segment	65	mW
Peak Forward Current Per Segment (1/10 Duty Cycle, .01ms pulse width)	100	mA
Continuous Forward Current Per Segment Derating Linearly From 25°C Per Segment	25 0.25	mA mA/°C
Reverse Voltage Per Segment	5	V
Operating Temperature Range	-40°C to +105°C	
Storage Temperature Range	-40°C to +105°C	

Electrical / Optical Characteristics @ T_A=25°C

Green

Parameters	Symbol	Min	Typ	Max	Unit	Test Condition
Average Luminous Intensity	I _V	5.4	10.5	-	Mcd	I _F = 10mA
Emissions Wavelength	λ _p /λ _d	-	572/571	-	Nm	I _F = 20mA
Spectral Line Half-Width	Δλ	-	20	-	Nm	I _F = 20mA
Forward Voltage, Per Segment	V _F	-	2.1	2.6	V	I _F = 20mA
Reverse Current, Per Segment	I _R	-	-	100	μA	V _R = 5V
Luminous Intensity Matching Ratio	I _{V-M}	-	-	2:1	-	I _F = 10mA

Yellow

Parameters	Symbol	Min	Typ	Max	Unit	Test Condition
Average Luminous Intensity	I _V	8.6	20	-	Mcd	I _F = 10mA
Emissions Wavelength	λ _p /λ _d	-	591/589	-	Nm	I _F = 20mA
Spectral Line Half-Width	Δλ	-	15	-	Nm	I _F = 20mA
Forward Voltage, Per Segment	V _F	-	2.1	2.6	V	I _F = 20mA
Reverse Current, Per Segment	I _R	-	-	100	μA	V _R = 5V
Luminous Intensity Matching Ratio	I _{V-M}	-	-	2:1	-	I _F = 10mA

Red

Parameters	Symbol	Min	Typ	Max	Unit	Test Condition
Average Luminous Intensity	I _V	8.6	16	-	Mcd	I _F = 10mA
Emissions Wavelength	λ _p /λ _d	-	632/624	-	Nm	I _F = 20mA
Spectral Line Half-Width	Δλ	-	20	-	Nm	I _F = 20mA
Forward Voltage, Per Segment	V _F	-	2.0	2.6	V	I _F = 20mA
Reverse Current, Per Segment	I _R	-	-	100	μA	V _R = 5V
Luminous Intensity Matching Ratio	I _{V-M}	-	-	2:1	-	I _F = 10mA

Orange

Parameters	Symbol	Min	Typ	Max	Unit	Test Condition
Average Luminous Intensity	I _V	8.6	19.5	-	Mcd	I _F = 10mA
Emissions Wavelength	λ _p /λ _d	-	611/605	-	Nm	I _F = 20mA
Spectral Line Half-Width	Δλ	-	17	-	Nm	I _F = 20mA
Forward Voltage, Per Segment	V _F	-	2.1	2.6	V	I _F = 20mA
Reverse Current, Per Segment	I _R	-	-	100	μA	V _R = 5V
Luminous Intensity Matching Ratio	I _{V-M}	-	-	2:1	-	I _F = 10mA

Typical Electrical / Optical characteristic curves @ $T_A=25^\circ\text{C}$
Green

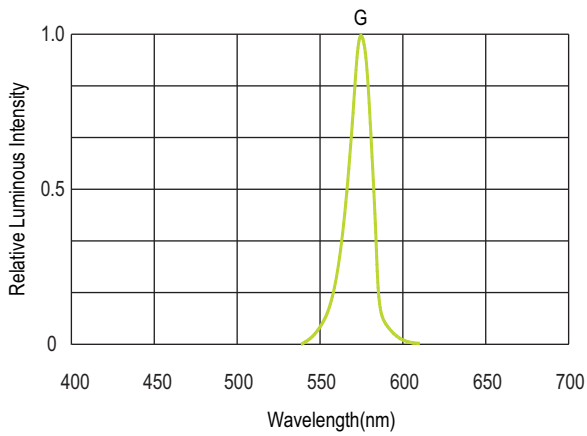

Figure 1. Relative Luminous Intensity vs. Wavelength

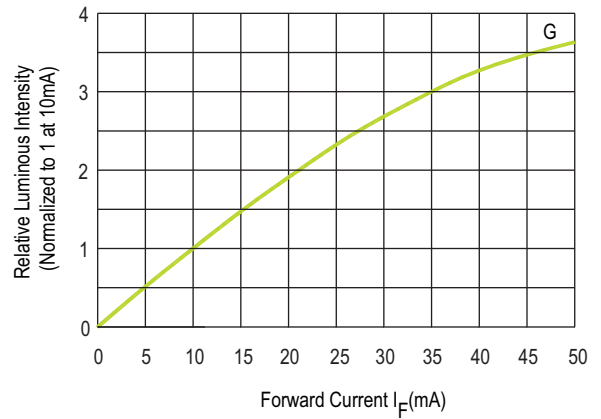

Figure 2. Relative Luminous Intensity vs. Forward Current

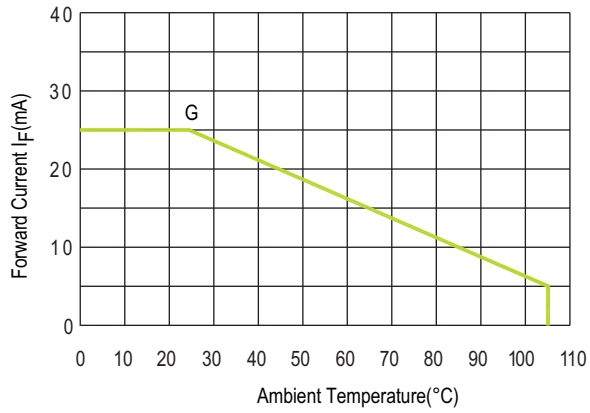

Figure 3. Allowable DC Current vs. Ambient Temperature

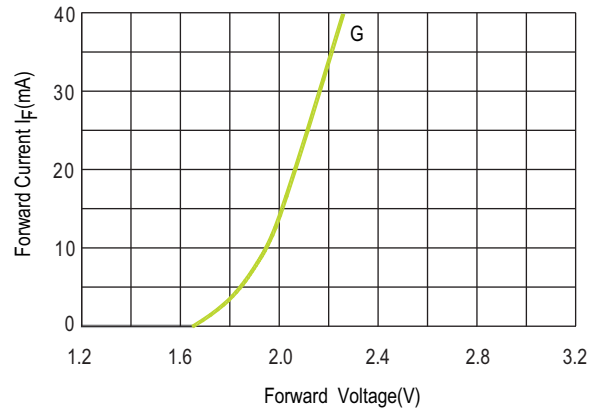

Figure 4. Forward Current vs. Forward Voltage

Yellow

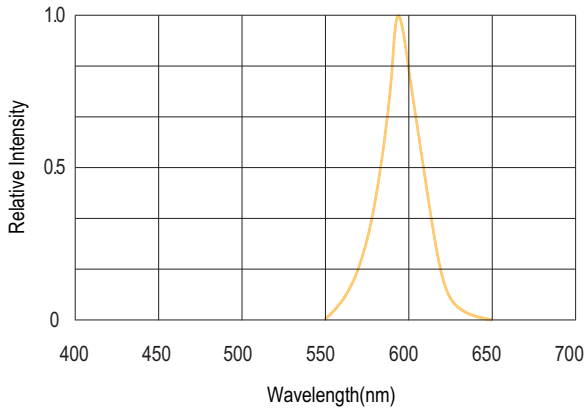

Figure 1. Relative Intensity vs. Wavelength

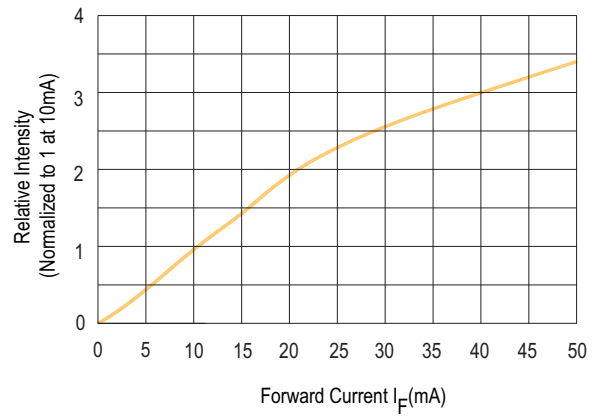

Figure 2. Relative Intensity vs. Forward Current

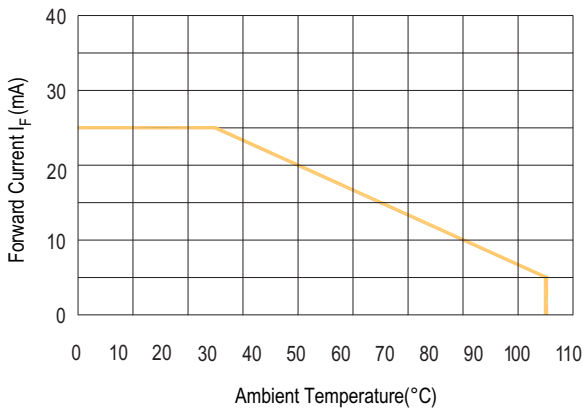

Figure 3. Allowable DC Current vs. Ambient Temperature

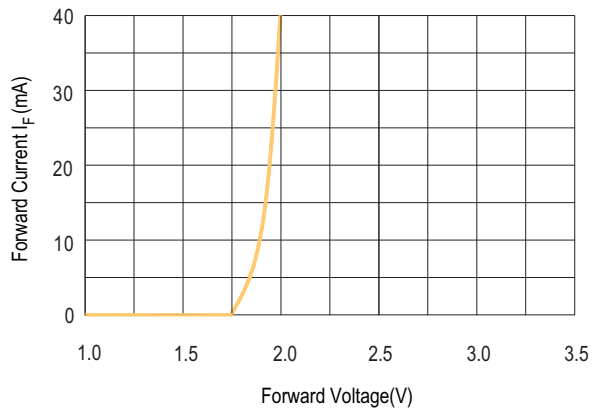

Figure 4. Forward Current vs. Forward Voltage

Red

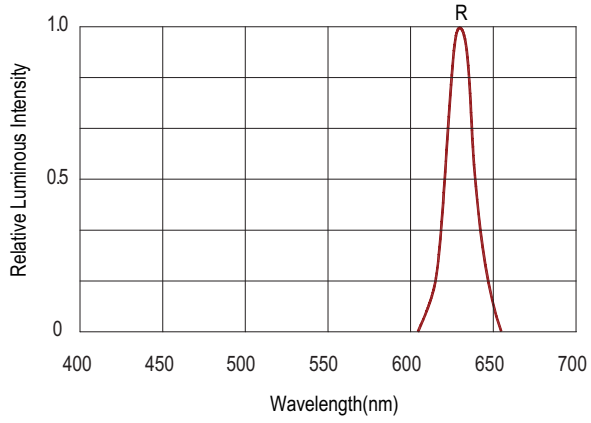

Figure 1. Relative Luminous Intensity vs. Wavelength

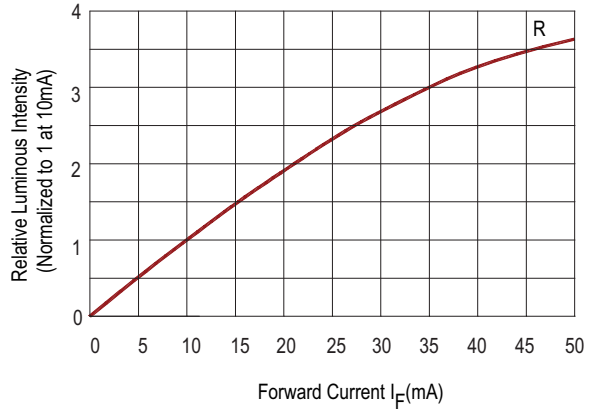

Figure 2. Relative Luminous Intensity vs. Forward Current

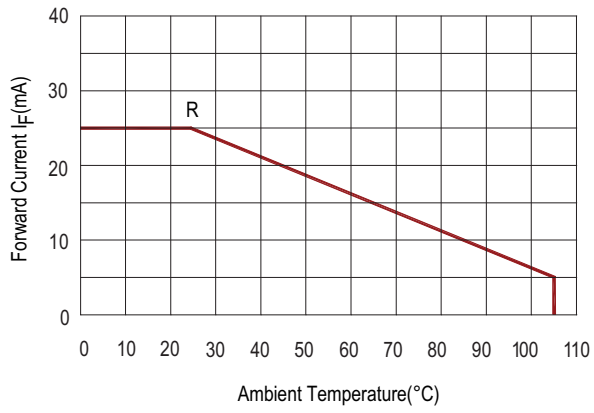

Figure 3. Allowable DC Current vs. Ambient Temperature

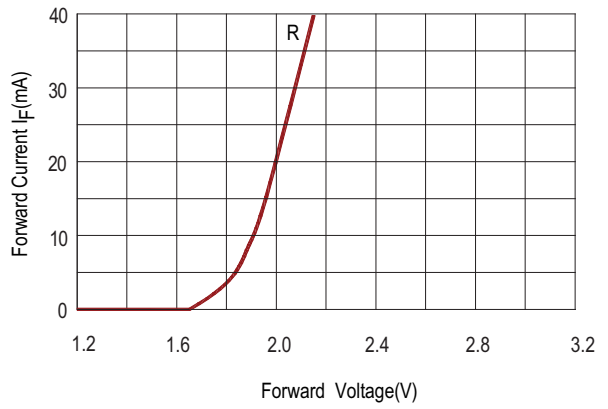

Figure 4. Forward Current vs. Forward Voltage

Orange

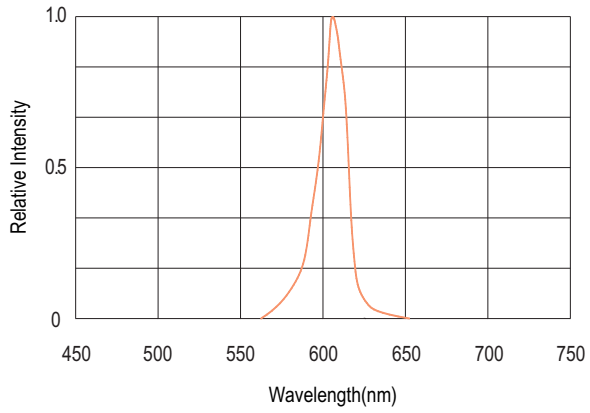

Figure 1. Relative Intensity vs. Wavelength

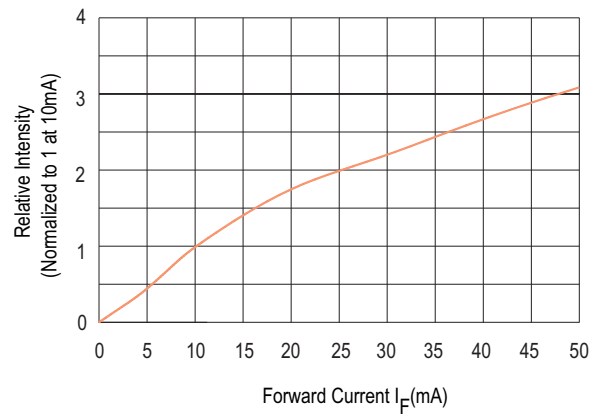

Figure 2. Relative Intensity vs. Forward Current

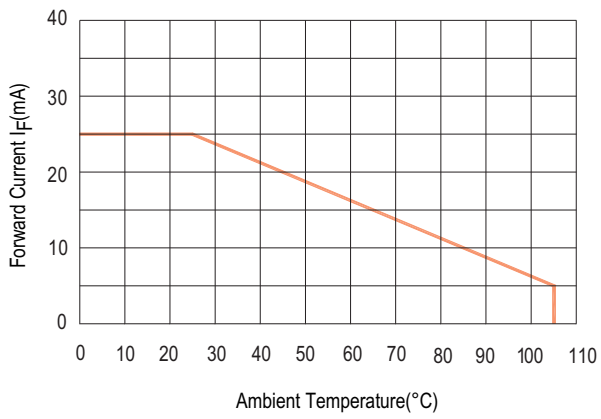

Figure 3. Allowable DC Current vs. Ambient Temperature

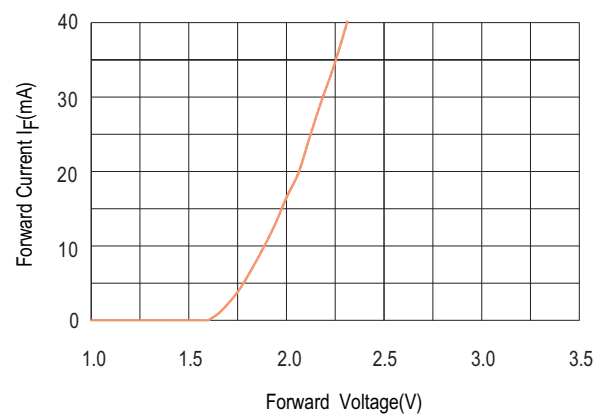

Figure 4. Forward Current vs. Forward Voltage

Intensity Bin Limits (mcd)

Green

IV Bin Category	Min.	Max
M	5.401	8.600
N	8.601	13.700
P	13.701	21.800
Q	21.801	34.700

Tolerance: ±15%

Yellow / Red / Orange

IV Bin Category	Min.	Max
N	8.601	13.700
P	13.701	21.800
Q	21.801	34.700
R	34.701	55.200

Tolerance: ±15%

Note:

1. Bin categories are established for classification of products. Products may not be available in all categories. Please contact your Avago representative for information on currently available bins.

SMT Soldering Profile

Pb free reflow soldering Profile

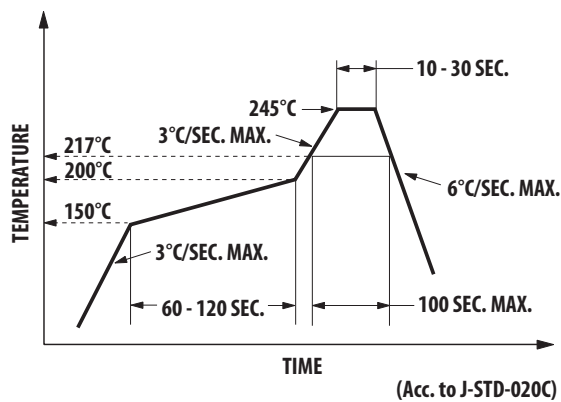

Notes:

1. The peak temperature refers to the peak package body temperature.
2. Number of reflow process shall be limited to maximum 2 times only. Cooling process to normal temperature is required between first and second soldering process.

Recommended soldering pattern (unit: mm)

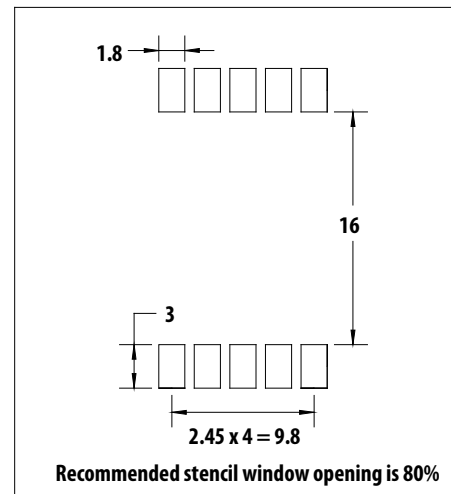

Tape specification (unit: mm)

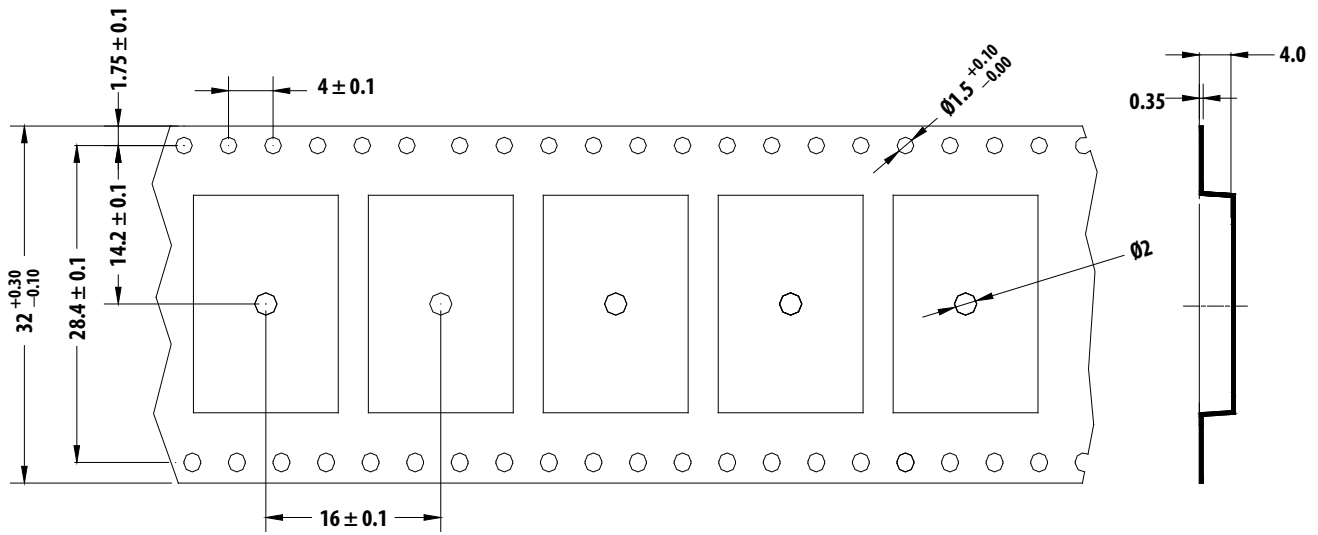

For product information and a complete list of distributors, please go to our web site: www.avagotech.com

Avago, Avago Technologies, and the A logo are trademarks of Avago Technologies in the United States and other countries. Data subject to change. Copyright © 2005-2011 Avago Technologies. All rights reserved. AV02-0713EN - March 17, 2011



Компания «Life Electronics» занимается поставками электронных компонентов импортного и отечественного производства от производителей и со складов крупных дистрибьюторов Европы, Америки и Азии.

С конца 2013 года компания активно расширяет линейку поставок компонентов по направлению коаксиальный кабель, кварцевые генераторы и конденсаторы (керамические, пленочные, электролитические), за счёт заключения дистрибьюторских договоров

Мы предлагаем:

- Конкурентоспособные цены и скидки постоянным клиентам.
- Специальные условия для постоянных клиентов.
- Подбор аналогов.
- Поставку компонентов в любых объемах, удовлетворяющих вашим потребностям.
- Приемлемые сроки поставки, возможна ускоренная поставка.
- Доставку товара в любую точку России и стран СНГ.
- Комплексную поставку.
- Работу по проектам и поставку образцов.
- Формирование склада под заказчика.
- Сертификаты соответствия на поставляемую продукцию (по желанию клиента).
- Тестирование поставляемой продукции.
- Поставку компонентов, требующих военную и космическую приемку.
- Входной контроль качества.
- Наличие сертификата ISO.

В составе нашей компании организован Конструкторский отдел, призванный помогать разработчикам, и инженерам.

Конструкторский отдел помогает осуществить:

- Регистрацию проекта у производителя компонентов.
- Техническую поддержку проекта.
- Защиту от снятия компонента с производства.
- Оценку стоимости проекта по компонентам.
- Изготовление тестовой платы монтаж и пусконаладочные работы.



Тел: +7 (812) 336 43 04 (многоканальный)
Email: org@lifeelectronics.ru