

Series 41

Characteristics

The rectangular design of the Series 41 (18x24 mm) makes it especially suited:

- Raised design
- PCB (with adaptor)

The series features a compact double-lit element that can be fitted from the front as a snap-on module.

Functions

The Series 41 incorporates the following functions:

- Indicator
- Illuminated pushbutton

Market segments

The EAO Series 41 is especially suited for applications in the segment:

- Machinery and Automation

Please refer to the EAO website to obtain detailed information regarding this series www.products.eao.com
Configure a product to your exact needs and request a quotation.



Overview**Raised design**

Indicator 4

Illuminated pushbutton 5

Accessories 7**Drawings** 14**Technical data** 15**Marking** 17**Guidelines for use** 18**Index** 19

41 Raised design

Indicator, IP 40



Product can differ from the current configuration.

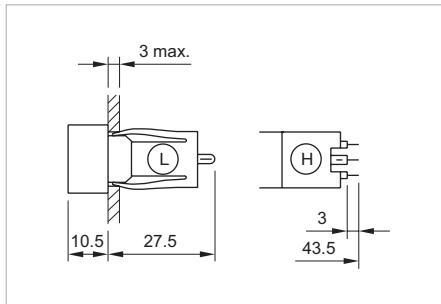

Dimensions [mm]
L = Solder terminal,
H = Universal terminal 2.0 x 0.5 mm

Equipment consisting of (schematic overview)



Lens

page 7



2 LEDs

page 10

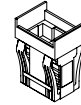



Actuator

Each Part Number listed below includes all the black components shown in the 3D-drawing.

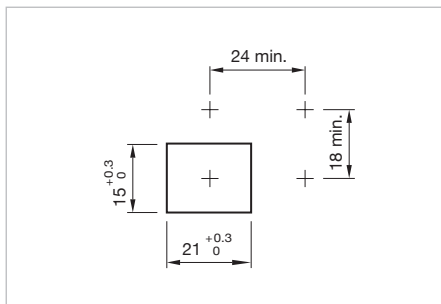
To obtain a complete unit, please select the red components from the pages shown.



Mounting cut-outs [mm]

Terminal	Part No.	Wiring diagram	Weight
 <p>Indicator, Front dimension 18 x 24 mm</p>			
Solder	41-040.005	1	0.009 kg
 <p>Indicator, Front dimension 18 x 24 mm</p>			
Universal 2.0 x 0.5 mm	41-041.006	1	0.009 kg

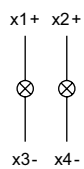

Wiring diagram 1

Illuminated pushbutton, IP 40

Equipment consisting of (schematic overview)

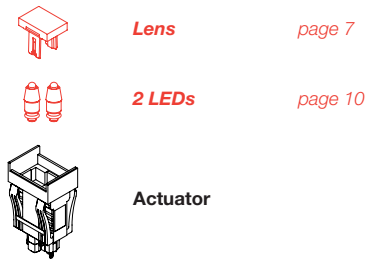

Each Part Number listed below includes all the black components shown in the 3D-drawing.

To obtain a complete unit, please select the red components from the pages shown.

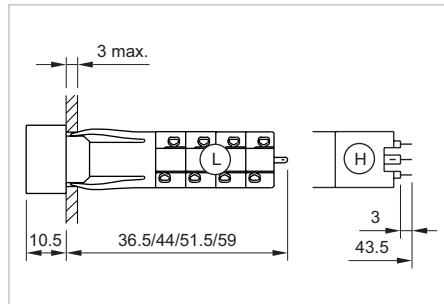



Dimensions [mm]
L = Solder terminal,
H = Universal terminal 2.0 x 0.5 mm

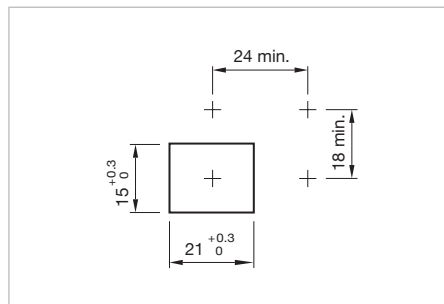

Product can differ from the current configuration.



Mounting cut-outs [mm]

Switching system	Contacts	Switching action	Terminal	Part No.	Wiring diagram	Weight
 <p>Illuminated pushbutton, Front dimension 18 x 24 mm</p>						
Snap-action switching element	1 NC + 1 NO	B	Solder	41-121.0252	1	0.011 kg
		C	Solder	41-261.0252	2	0.011 kg
	2 NC + 2 NO	B	Solder	41-122.0252	3	0.012 kg
		C	Solder	41-262.0252	4	0.013 kg
	3 NC + 3 NO	B	Solder	41-123.0252	5	0.014 kg
		C	Solder	41-263.0252	6	0.014 kg
	4 NC + 4 NO	B	Solder	41-124.0252	7	0.015 kg
		C	Solder	41-264.0252	8	0.015 kg
 <p>Illuminated pushbutton, Front dimension 18 x 24 mm</p>						
Low-level element	2 NO	B	Universal 2.0 x 0.5 mm	41-421.036	9	0.014 kg
		C	Universal 2.0 x 0.5 mm	41-461.036	10	0.014 kg
	2 NC	B	Universal 2.0 x 0.5 mm	41-422.036	11	0.014 kg
		C	Universal 2.0 x 0.5 mm	41-462.036	12	0.014 kg
	1 NC + 1 NO	B	Universal 2.0 x 0.5 mm	41-423.036	13	0.014 kg
		C	Universal 2.0 x 0.5 mm	41-463.036	14	0.014 kg

Contacts: NC = Normally closed, NO = Normally open
Switching action: B = Momentary, C = Maintained

41 Raised design

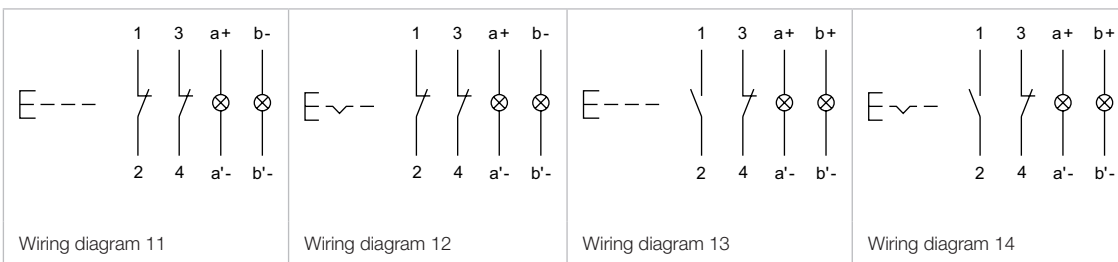

Front

Lens plastic single-colour

Product attribute	Dimension	Lens	Part No.	Weight		
 <p>Lens plastic single-colour</p>	15.3 x 21.5 mm	red transparent	41-903.2	0.001 kg		
		orange transparent	41-903.3	0.001 kg		
flat, illuminative	15.3 x 21.5 mm	yellow transparent	41-903.4	0.001 kg		
		green transparent	41-903.5	0.001 kg		
		blue transparent	41-903.6	0.001 kg		
		colourless transparent	41-903.7	0.001 kg		
		flat, illuminative, less suitable for film insert	15.3 x 21.5 mm	red transparent	41-904.2	0.001 kg
				orange transparent	41-904.3	0.001 kg
yellow transparent	41-904.4			0.001 kg		
green transparent	41-904.5			0.001 kg		
flat, illuminative, less suitable for film insert	15.3 x 21.5 mm	colourless transparent	41-904.7	0.001 kg		

Lens plastic bi-colour

Product attribute	Dimension	Lens	Part No.	Weight		
 <p>Lens plastic bi-colour</p>	15.3 x 21.5 mm	red-orange transparent	41-907.2/3	0.002 kg		
		red-yellow transparent	41-907.2/4	0.002 kg		
flat, illuminative	15.3 x 21.5 mm	red-green transparent	41-907.2/5	0.002 kg		
		red-blue transparent	41-907.2/6	0.002 kg		
		red-colourless transparent	41-907.2/7	0.002 kg		
		orange-green transparent	41-907.3/5	0.002 kg		
		orange-blue transparent	41-907.3/6	0.002 kg		
		orange-colourless transparent	41-907.3/7	0.002 kg		
		yellow-green transparent	41-907.4/5	0.002 kg		
		yellow-blue transparent	41-907.4/6	0.002 kg		
		yellow-colourless transparent	41-907.4/7	0.002 kg		
		green-blue transparent	41-907.5/6	0.002 kg		
		green-colourless transparent	41-907.5/7	0.002 kg		
		blue-colourless transparent	41-907.6/7	0.002 kg		
		colourless-colourless transparent	41-907.7/7	0.002 kg		
		flat, illuminative, less suitable for film insert	15.3 x 21.5 mm	red-orange transparent	41-908.2/3	0.002 kg
				red-yellow transparent	41-908.2/4	0.002 kg
				red-green transparent	41-908.2/5	0.002 kg
red-colourless transparent	41-908.2/7			0.002 kg		
orange-yellow transparent	41-908.3/4			0.002 kg		
orange-green transparent	41-908.3/5			0.002 kg		

41 Accessories

Product attribute	Dimension	Lens	Part No.	Weight
flat, illuminative, less suitable for film insert	15.3 x 21.5 mm	orange-colourless transparent	41-908.3/7	0.002 kg
		yellow-green transparent	41-908.4/5	0.002 kg
		yellow-colourless transparent	41-908.4/7	0.002 kg
		green-colourless transparent	41-908.5/7	0.002 kg
		colourless-colourless transparent	41-908.7/7	0.002 kg

Protective cover, IP 40

Additional Information

- Hinged, with means for sealing
- Front panel thickness reduces by 2 mm
- Please note that bigger minimum distances are necessary

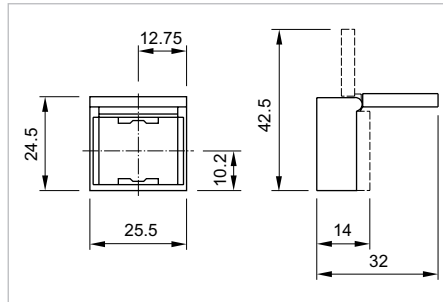

Dimensions [mm]

Product attribute	Dimension	Material	Optics	Part No.	Weight
 <p>Protective cover</p>					
for button with front dimension 15 x 21 mm	18 x 24 mm	Plastic	transparent	41-925	0.002 kg

Blind plug

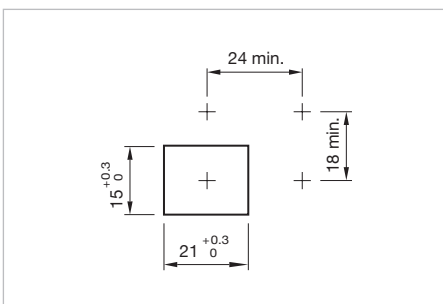

Einbauöffnungen [mm]

Dimension	Material	Colour	Part No.	Weight
 <p>Blind plug</p>				
18 x 24 mm	Plastic	black	41-947.0	0.002 kg

Rear side

PCB plug-in base

Dimension	Pins	Terminal	Part No.	Weight
 <p>PCB plug-in base</p>				
23.8 x 17.7 x 9.8 mm	axial	PCB	41-940	0.004 kg

The component layouts you will find from page 14

Flat receptacle

Product attribute	Part No.	Weight
 <p>Flat receptacle</p>		
2.0 x 0.5 mm plug-in terminal	31-945	0.001 kg

Insulation sleeve

Product attribute	Part No.	Weight
 <p>Insulation sleeve</p>		
for flat receptacle 2.0 mm	31-928	0.001 kg

41 Accessories

Illumination

LED, T1 3/4 MG

Additional Information

- Due to high surface temperatures, the series resistor must not be soldered directly to the terminals of the equipment (use a terminal plate)
- Order two LEDs
- When using AC/DC types with AC operation, slight flickering can occur
- Luminous intensity data of the LEDs on direct voltage
- Electrical and optical data are measured at 25 °C
- The specified versions are built with a protection diode (half wave rectifier) in series and the LED
- Luminosity and wave length variations caused by LED manufacturing processes may cause slight differences regarding the illumination



Dimensions [mm]

LED colour	Operating voltage	Operation current	Lumi. intensity	Dom. wavelength	Part No.	Weight
 <p>Single-LED</p>						
Single-LED red	6 VDC +10 %	15 mA ±15 %	350 mcd	630 nm	10-2J06.3142	0.002 kg
	12 VAC/DC +10 %	7/14 mA ±15 %	330 mcd	630 nm	10-2J09.1062	0.002 kg
	24 VAC/DC +10 %	7/14 mA ±15 %	330 mcd	630 nm	10-2J12.1062	0.002 kg
	28 VAC/DC +10 %	7/14 mA ±15 %	330 mcd	630 nm	10-2J13.1062	0.002 kg
	48 VAC/DC +10 %	4/8 mA ±15 %	200 mcd	630 nm	10-2J19.1042	0.002 kg
Single-LED yellow	6 VDC +10 %	15 mA ±15 %	300 mcd	587 nm	10-2J06.3144	0.002 kg
	12 VAC/DC +10 %	7/14 mA ±15 %	280 mcd	587 nm	10-2J09.1064	0.002 kg
	24 VAC/DC +10 %	7/14 mA ±15 %	280 mcd	587 nm	10-2J12.1064	0.002 kg
	28 VAC/DC +10 %	7/14 mA ±15 %	280 mcd	587 nm	10-2J13.1064	0.002 kg
	48 VAC/DC +10 %	4/8 mA ±15 %	180 mcd	587 nm	10-2J19.1044	0.002 kg
Single-LED green	6 VDC +10 %	7 mA ±15 %	1050 mcd	525 nm	10-2J06.3145	0.002 kg
	12 VAC/DC +10 %	4/7 mA ±15 %	1050 mcd	525 nm	10-2J09.1065	0.002 kg
	24 VAC/DC +10 %	4/7 mA ±15 %	1050 mcd	525 nm	10-2J12.1065	0.002 kg
	28 VAC/DC +10 %	4/7 mA ±15 %	1050 mcd	525 nm	10-2J13.1065	0.002 kg
	48 VAC/DC +10 %	2/4 mA ±15 %	600 mcd	525 nm	10-2J19.1045	0.002 kg
Single-LED blue	6 VDC +10 %	15 mA ±15 %	680 mcd	470 nm	10-2J06.3146	0.002 kg
	12 VAC/DC +10 %	7/14 mA ±15 %	650 mcd	470 nm	10-2J09.1066	0.002 kg
	24 VAC/DC +10 %	7/14 mA ±15 %	650 mcd	470 nm	10-2J12.1066	0.002 kg
	28 VAC/DC +10 %	7/14 mA ±15 %	650 mcd	470 nm	10-2J13.1066	0.002 kg
	48 VAC/DC +10 %	4/8 mA ±15 %	400 mcd	470 nm	10-2J19.1046	0.002 kg
Single-LED white	6 VDC +10 %	15 mA ±15 %	750 mcd	x0.31/y0.32 nm	10-2J06.3149	0.002 kg
	12 VAC/DC +10 %	7/14 mA ±15 %	700 mcd	x0.31/y0.32 nm	10-2J09.1069	0.002 kg
	24 VAC/DC +10 %	7/14 mA ±15 %	700 mcd	x0.31/y0.32 nm	10-2J12.1069	0.002 kg
	28 VAC/DC +10 %	7/14 mA ±15 %	700 mcd	x0.31/y0.32 nm	10-2J13.1069	0.002 kg
	48 VAC/DC +10 %	4/8 mA ±15 %	400 mcd	x0.31/y0.32 nm	10-2J19.1049	0.002 kg

Filament lamp, T1 3/4 MG

- Order two filament lamps

Operating voltage	Operation current	Part No.	Weight
 <p>Filament lamp</p>			
6 VAC/DC	120 mA±10 %	10-1306.1349	0.001 kg
6.3 VAC/DC	200 mA±10 %	10-1307.1369	0.001 kg
12 VAC/DC	75 mA±10 %	10-1309.1309	0.001 kg
14 VAC/DC	80 mA±10 %	10-1310.1319	0.001 kg
18 VAC/DC	40 mA±10 %	10-1311.1249	0.001 kg
24 VAC/DC	35 mA±10 %	10-1312.1229	0.001 kg
28 VAC/DC	30 mA±10 %	10-1313.1209	0.001 kg
28 VAC/DC	40 mA±10 %	10-1313.1249	0.001 kg
36 VAC/DC	20 mA±10 %	10-1316.1179	0.001 kg
36 VAC/DC	30 mA±10 %	10-1316.1209	0.001 kg
48 VAC/DC	20 mA±10 %	10-1319.1179	0.001 kg
48 VAC/DC	25 mA±10 %	10-1319.1199	0.001 kg

Series resistor

Additional Information

- Only for filament lamp 48 VAC, 25 mA
- For lamp voltage reduction
- Keep to the country specific safety instructions
- Due to high surface temperatures, the series resistor must not be soldered directly to the terminals of the equipment (use a terminal plate)

Operating voltage	Resistance	Part No.	Weight
 <p>Series resistor</p>			
110 VAC	2.7 kOhm	02-904.0	0.003 kg
125 VAC	3.3 kOhm	02-904.1	0.003 kg
145 VAC	4.7 kOhm	02-904.3	0.003 kg
240 VAC	10 kOhm	02-904.7	0.003 kg

41 Accessories

Terminal plate empty

Product attribute	Dimension	Part No.	Weight
 Terminal plate empty			
5 spaces	62.5 x 60 x 15 mm	02-912.1	0.025 kg
10 spaces	125 x 60 x 15 mm	02-912.2	0.045 kg
15 spaces	187.6 x 60 x 15 mm	02-912.3	0.090 kg
20 spaces	250 x 60 x 15 mm	02-912.4	0.095 kg

Mounting

Lens remover

Product attribute	Part No.	Weight
 <p>Lens remover</p>		
for raised design	02-905	0.011 kg

Lamp remover

Additional Information

▲ **Caution:** A switching process might be released when replacing the lamp

Part No.	Weight
 <p>Lamp remover</p>	
61-9740.0	0.003 kg

Dismantling tool

Part No.	Weight
 <p>Dismantling tool</p>	
41-939	0.027 kg

41 Drawings

Drawings

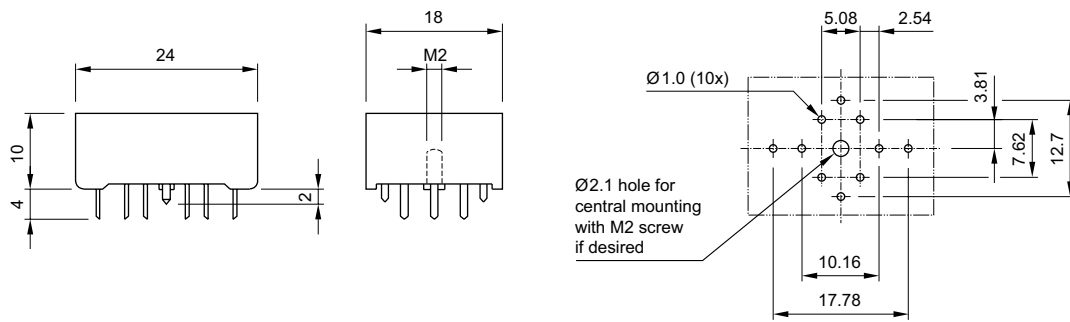

Actuator with snap-action switching element
Switching system

Self-cleaning, double-break, snap action switching system (with contact gap 2 x 0.5 mm).

1 normally closed or 1 normally open contact per element.
Up to 4 switching elements can be on a pushbutton (max. 4 normally closed and 4 normally open contacts).

Material
Material of contacts

gold-plated silver

Switching element

Soldering terminal: PA 6.6 Ultramid

Actuator case

Polysulfone, heat-resistant and self-extinguishing

Mechanical characteristics
Connection method

Snap-action switching element with tinned soldering terminals at the sides:

max. wire diameter: 2 wires à 1.2 mm

max. wire cross-section of stranded cable: 1x 1 mm²

Actuating force

2-5.5 N, depending on the number of switching elements

Actuating travel

3 mm

Mechanical life

Momentary action 2 million cycles of operation

Maintained action 1 million cycles of operation

Electrical characteristics
Standards

IEC 61058 EN 61058

Rated voltage

250 VAC/VDC

Rated current

5 A

Volume resistance

Starting value $\leq 50 \text{ m}\Omega$

Conventional free air thermal current I_{th}

5 A

The maximum current in continuous operation and at ambient temperature not exceeding the quoted maximum values.

Switch rating

250 VAC/5 A ($\cos\phi$ 1)

250 VAC/3 A ($\cos\phi$ 0.3)

Switch rating AC, $\cos\phi$ 0.7:

Voltage 125 V 250 V

Current 3 A 2 A

Switch rating DC (inductive), L:R = 30 ms

Voltage 24 V 60 V 110 V 220 V

Current 2 A 0.7 A 0.2 A 0.1 A

Electric strength

2500 VAC, 50 Hz, 1 min. between all terminals and earth, as per IEC 60512-2-11

Protection class

II

Environmental conditions
Storage temperature

-40 °C to +85 °C

Service temperature

-25 °C to +55 °C

for indicators and illuminated pushbuttons mounted as a block, make sure the heat can escape freely

Degree of protection

Front as per IEC 60529: IP 40

Resistance to shock

(single impacts, semi-sinusoidal)

15 g for 11 ms as per IEC 60512-4-3, IEC 60068-2-27

Resistance to vibration

(sinusoidal)

10 g at 0-2000 Hz, amplitude 1.5 mm as per IEC 60512-4-4, IEC 60068-2-6

Resistance to climate

Standard condition as per IEC 60068-2-3 and 2-30

Changing condition as per IEC 60068-2-14 and 2-33

Approvals
Approbations

CB (IEC 61058)

CSA

UL

Germanischer Lloyd

Declaration of conformity

CE

41 Technical data

Actuator with Low Level switching element

Switching system

This low level switching element was designed for switching low powers in electronic circuits. The mechanism assures reliable switching of loads ranging from a few mA/mV up to 100mA/42 VAC/VDC.

Single-break momentary contact, as normally open or normally closed with 4 independent points of contact. 2 momentary contacts per switching element; combination of normally open and normally closed is possible.

Special features are the long life, extremely short rebound time and stable contact resistance.

Material

Actuator case

Polysulfone, heat-resistant and self-extinguishing

Material of contacts

gold-plated

Switching element

Polysulfone, heat-resistant and self-extinguishing

Mechanical characteristics

Connection method

The universal terminals permit these units to be mounted on printed circuit boards (PCB). These terminals can also be used as soldering or plug-in terminals.

For these terminals we can also supply a plug-in base which, when soldered on to the board, enables the switch to be plugged in.

Soldering terminal

max. wire diameter: 2 wires of 0.8 mm

max. wire cross-section of stranded cable: 1 x 0.75 mm²

Plug-in terminal

2.0 x 0.5 mm

Actuating force

3-3.5 N

Actuating travel

3 mm

Rebound time

Typ. < 100 μs

Mechanical life

Momentary action 5 million cycles of operation

Maintained action 1 million cycles of operation

Electrical characteristics

Volume resistance

starting value ≤ 50 mΩ

Switch rating

10 μA/100 μV to 100 μA at 42 VAC/VDC

Electric strength

2500 VAC, 50 Hz, 1 min. between all terminals and earth, as per IEC 60512-2-11.

Protection class

II

Environmental conditions

Storage temperature

-40 °C to +85 °C

Service temperature

-25 °C to +55 °C

for indicators and illuminated pushbuttons mounted as a block, make sure the heat can escape freely

Degree of protection

Front as per IEC 60529: IP 40

Resistance to shock

(single impacts, semi-sinusoidal)

15 g for 11 ms as per IEC 60512-4-3, IEC 60068-2-27

Resistance to climate

Standard condition as per IEC 60068-2-3 and 2-30

Changing condition as per IEC 60068-2-14 and 2-33

General notes

1. Engraving

Typefaces

In addition to the most commonly used world languages (see DIN 1451) with close spacing, the following typefaces are available: Scandinavian, Slavian, Greek, Russian.

Coloured filling of engraving

Specify whether engraving should be on the diffuser, or on the lens. Specify the infill colour, character height and the text or symbol orientation.

Symbols

A list of the symbols available can be supplied on request.

2. Hot stamping

For large batches it is worth while to have the lettering produced by hot stamping.

Typefaces

For letters and figures, typefaces with 2.5 mm, 3 mm and 4 mm are available.

Symbols

A list of the symbols available can be supplied on request.

3. Film inserts

Instead of using engraving, the lenses can be fitted with transparent film inserts. For this purpose, though, it is advisable to use transparent lenses.

To insert the film, the feet of the lens support have to be pushed together far enough to enable the lens to be lifted off easily.

Film dimensions

max. 12.7 x 18.7 mm (monocolour lens)

max. 9 x 12.7 mm (two-colour lens)

Film thickness 0.2 mm

Important: Before engraving, check the position of the illuminated pushbuttons or indicator.

All dimensions in mm

Height of letters h	Thickness of letters s	Number of lines	Number of capital letters per line (target value)	Number of small letters per line (target value)	Image
2.5	0.4	4	11	12	B1
3	0.4	3	9-10	10-11	B1
4	0.5	2	7	7-8	B1
5	0.5	2	5-6	6	B1
6	0.6	1	4-5	5	B1
8	0.6	1	3-4	3-4	B1
2.5	0.4	5	7-8	8	B2
3	0.4	4	6-7	7	B2
4	0.5	3	4-5	5	B2
5	0.5	2	3-4	4	B2
6	0.6	2	3	3-4	B2
8	0.6	1	2-3	2-3	B2
2.5	0.4	4	5-6	5-6	B3
3	0.4	3	4-5	5	B3
4	0.5	2	3	3-4	B3
5	0.5	2	2-3	3	B3
6	0.6	1	2	2-3	B3
8	0.6	1	1-2	1-2	B3
2.5	0.4	2	7-8	8	B4
3	0.4	2	6-7	7	B4
4	0.5	1	4-5	5	B4
5	0.5	1	3-4	4	B4
6	0.6	1	3	3-4	B4
8	0.6	1	2-3	2-3	B4

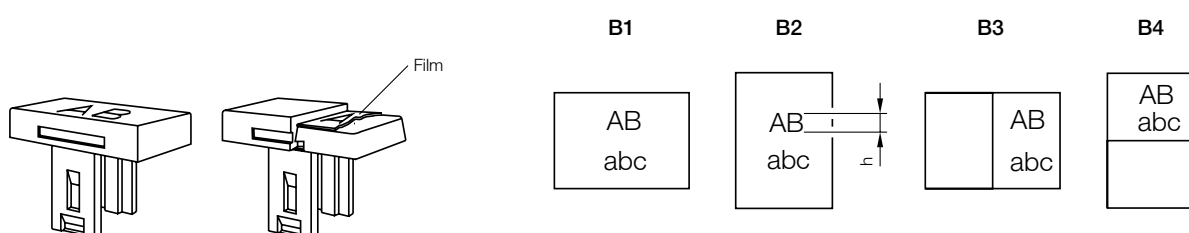

41 Application guidelines

Suppressor circuits

When switching inductive loads such as relays, DC motors, and DC solenoids, it is always important to absorb surges (e.g. with a diode) to protect the contacts. When these inductive loads are switched off, a counter emf can severely damage switch contacts and greatly shorten lifetime.

Fig. 1 shows an inductive load with a free-wheeling diode connected in parallel. This free-wheeling diode provides a path for the inductor current to flow when the current is interrupted by the switch. Without this free-wheeling diode, the voltage across the coil will be limited only by dielectric breakdown voltages of the circuit or parasitic elements of the coil. This voltage can be kilovolts in amplitude even when nominal circuit voltages are low (e.g. 12VDC) see Fig. 2.

The free-wheeling diode should be chosen so that the reverse breakdown voltage is greater than the voltage driving the inductive load. The DC blocking voltage (V_R) of the free-wheeling diode can be found in the datasheet of a diode. The forward current should be equal or greater than the maximum current flowing through the load.

To get an efficient protection, the free-wheeling diode must be connected as close as possible to the inductive load!

Switching with inductive load
Fig. 1

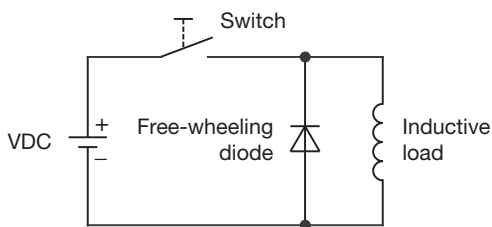

Counter EMF
over load without free-wheeling diode
Fig. 2

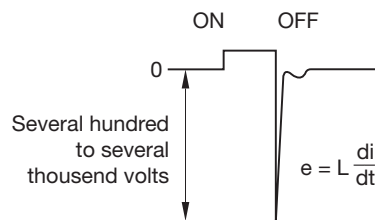

Index from Part No.

Part No.	Page	Part No.	Page
02-904.0	11	41-907.2/5	7
02-904.1	11	41-907.2/6	7
02-904.3	11	41-907.2/7	7
02-904.7	11	41-907.3/5	7
02-905	13	41-907.3/6	7
02-912.1	12	41-907.3/7	7
02-912.2	12	41-907.4/5	7
02-912.3	12	41-907.4/6	7
02-912.4	12	41-907.4/7	7
10-1306.1349	11	41-907.5/6	7
10-1307.1369	11	41-907.5/7	7
10-1309.1309	11	41-907.6/7	7
10-1310.1319	11	41-907.7/7	7
10-1311.1249	11	41-908.2/3	7
10-1312.1229	11	41-908.2/4	7
10-1313.1209	11	41-908.2/5	7
10-1313.1249	11	41-908.2/7	7
10-1316.1179	11	41-908.3/4	7
10-1316.1209	11	41-908.3/5	7
10-1319.1179	11	41-908.3/7	8
10-1319.1199	11	41-908.4/5	8
10-2J06.3142	10	41-908.4/7	8
10-2J06.3144	10	41-908.5/7	8
10-2J06.3145	10	41-908.7/7	8
10-2J06.3146	10	41-925	8
10-2J06.3149	10	41-939	13
10-2J09.1062	10	41-940	9
10-2J09.1064	10	41-947.0	8
10-2J09.1065	10	61-9740.0	13
10-2J09.1066	10		
10-2J09.1069	10		
10-2J12.1062	10		
10-2J12.1064	10		
10-2J12.1065	10		
10-2J12.1066	10		
10-2J12.1069	10		
10-2J13.1062	10		
10-2J13.1064	10		
10-2J13.1065	10		
10-2J13.1066	10		
10-2J13.1069	10		
10-2J19.1042	10		
10-2J19.1044	10		
10-2J19.1045	10		
10-2J19.1046	10		
10-2J19.1049	10		
31-928	9		
31-945	9		
41-040.005	4		
41-041.006	4		
41-121.0252	5		
41-122.0252	5		
41-123.0252	5		
41-124.0252	5		
41-261.0252	5		
41-262.0252	5		
41-263.0252	5		
41-264.0252	5		
41-421.036	5		
41-422.036	5		
41-423.036	5		
41-461.036	5		
41-462.036	5		
41-463.036	5		
41-903.2	7		
41-903.3	7		
41-903.4	7		
41-903.5	7		
41-903.6	7		
41-903.7	7		
41-904.2	7		
41-904.3	7		
41-904.4	7		
41-904.5	7		
41-904.7	7		
41-907.2/3	7		
41-907.2/4	7		

Компания «Life Electronics» занимается поставками электронных компонентов импортного и отечественного производства от производителей и со складов крупных дистрибьюторов Европы, Америки и Азии.

С конца 2013 года компания активно расширяет линейку поставок компонентов по направлению коаксиальный кабель, кварцевые генераторы и конденсаторы (керамические, пленочные, электролитические), за счёт заключения дистрибьюторских договоров

Мы предлагаем:

- Конкуренспособные цены и скидки постоянным клиентам.
- Специальные условия для постоянных клиентов.
- Подбор аналогов.
- Поставку компонентов в любых объемах, удовлетворяющих вашим потребностям.
- Приемлемые сроки поставки, возможна ускоренная поставка.
- Доставку товара в любую точку России и стран СНГ.
- Комплексную поставку.
- Работу по проектам и поставку образцов.
- Формирование склада под заказчика.
- Сертификаты соответствия на поставляемую продукцию (по желанию клиента).
- Тестирование поставляемой продукции.
- Поставку компонентов, требующих военную и космическую приемку.
- Входной контроль качества.
- Наличие сертификата ISO.

В составе нашей компании организован Конструкторский отдел, призванный помогать разработчикам, и инженерам.

Конструкторский отдел помогает осуществить:

- Регистрацию проекта у производителя компонентов.
- Техническую поддержку проекта.
- Защиту от снятия компонента с производства.
- Оценку стоимости проекта по компонентам.
- Изготовление тестовой платы монтаж и пусконаладочные работы.



Тел: +7 (812) 336 43 04 (многоканальный)
Email: org@lifeelectronics.ru