

MC74VHC257

Quad 2-Channel Multiplexer with 3-State Outputs

The MC74VHC257 is an advanced high speed CMOS quad 2-channel multiplexer fabricated with silicon gate CMOS technology. It achieves high speed operation similar to equivalent Bipolar Schottky TTL while maintaining CMOS low power dissipation.

It consists of four 2-input digital multiplexers with common select (S) and enable (\overline{OE}) inputs. When (\overline{OE}) is held High, selection of data is inhibited and all the outputs get Low.

The select decoding determines whether the A or B inputs get routed to the corresponding Y outputs.

The inputs tolerate voltages up to 7 V, allowing the interface of 5 V systems to 3 V systems.

- High Speed: $t_{PD} = 4.1$ ns (Typ) at $V_{CC} = 5.0$ V
- Low Power Dissipation: $I_{CC} = 4.0$ μ A (Max) at $T_A = 25^\circ$ C
- High Noise Immunity: $V_{NIH} = V_{NIL} = 28\%$ V_{CC}
- Power Down Protection Provided on Inputs
- Balanced Propagation Delays
- Designed for 2.0 V to 5.5 V Operating Range
- Low Noise: $V_{OLP} = 0.8$ V (Max)
- Pin and Function Compatible with Other Standard Logic Families
- Latchup Performance Exceeds 300 mA
- ESD Performance: HBM > 2000 V; Machine Model > 200 V
- Chip Complexity: FETs = 100; Equivalent Gates = 25
- These Devices are Pb-Free and are RoHS Compliant

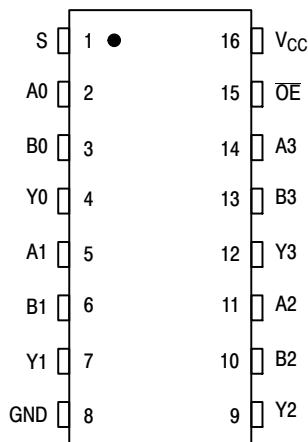

Figure 1. Pin Assignment



ON Semiconductor™

<http://onsemi.com>

MARKING DIAGRAMS

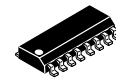

SO-16
D SUFFIX
CASE 751B



TSSOP-16
DT SUFFIX
CASE 948F

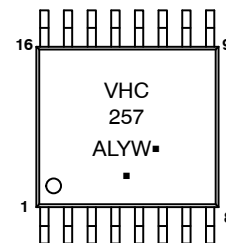

EIAJ SO-16
M SUFFIX
CASE 966

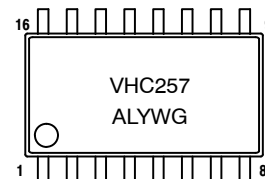

A = Assembly Location
L, WL = Wafer Lot
Y, YY = Year
W, WW = Work Week
G or ■ = Pb-Free Package

ORDERING INFORMATION

| Device | Package | Shipping |
|-----------------|------------|-----------------|
| MC74VHC257DG | SO-16 | 48 Units/Rail |
| MC74VHC257DR2G | SO-16 | 2500 Units/Reel |
| MC74VHC257DTG | TSSOP-16 | 96 Units/Rail |
| MC74VHC257DTR2G | TSSOP-16 | 2500 Units/Reel |
| MC74VHC257MG | EIAJ SO-16 | 50 Units/Rail |

MC74VHC257

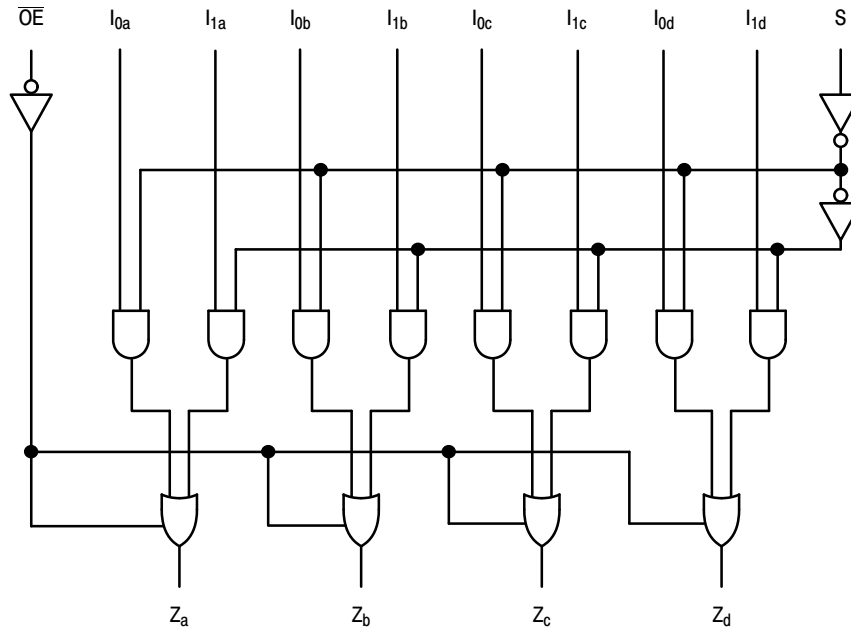

Figure 2. Expanded Logic Diagram

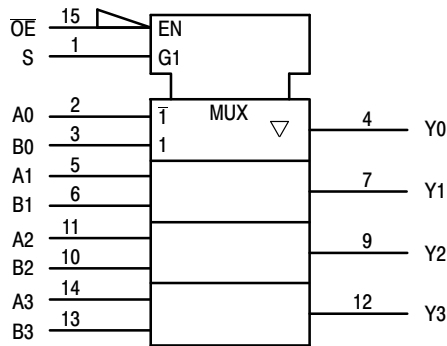

Figure 3. IEC Logic Symbol

FUNCTION TABLE

| Inputs | | Outputs Y0 - Y3 |
|--------|---|--------------------|
| OE | S | |
| H | X | Z |
| L | L | A0 - A3 |
| L | H | B0 - B3 |

A0 - A3, B0 - B3 = the levels of the respective Data-Word Inputs.

This device contains protection circuitry to guard against damage due to high static voltages or electric fields. However, precautions must be taken to avoid applications of any voltage higher than maximum rated voltages to this high-impedance circuit. For proper operation, V_{in} and V_{out} should be constrained to the range $GND \leq (V_{in} \text{ or } V_{out}) \leq V_{CC}$. Unused inputs must always be tied to an appropriate logic voltage level (e.g., either GND or V_{CC}). Unused outputs must be left open.

MC74VHC257

MAXIMUM RATINGS

| Symbol | Parameter | Value | Unit | |
|----------------------|---|--|------------------------|------|
| V _{CC} | Positive DC Supply Voltage | -0.5 to +7.0 | V | |
| V _{IN} | Digital Input Voltage | -0.5 to +7.0 | V | |
| V _{OUT} | DC Output Voltage | -0.5 to V _{CC} +0.5 | V | |
| I _{IK} | Input Diode Current | -20 | mA | |
| I _{OK} | Output Diode Current | ± 20 | mA | |
| I _{OUT} | DC Output Current, per Pin | ± 25 | mA | |
| I _{CC} | DC Supply Current, V _{CC} and GND Pins | ± 75 | mA | |
| P _D | Power Dissipation in Still Air | SOIC Package TSSOP | 200 180 | mW |
| T _{STG} | Storage Temperature Range | -65 to +150 | °C | |
| V _{ESD} | ESD Withstand Voltage | Human Body Model (Note 1) Machine Model (Note 2) Charged Device Model (Note 3) | >2000 >200 >2000 | V |
| I _{LATCHUP} | Latchup Performance | Above V _{CC} and Below GND at 125°C (Note 4) | ± 300 | mA |
| θ _{JA} | Thermal Resistance, Junction-to-Ambient | SOIC Package TSSOP | 143 164 | °C/W |

Stresses exceeding Maximum Ratings may damage the device. Maximum Ratings are stress ratings only. Functional operation above the Recommended Operating Conditions is not implied. Extended exposure to stresses above the Recommended Operating Conditions may affect device reliability.

- 1 Tested to EIA/JESD22-A114-A
- 2 Tested to EIA/JESD22-A115-A
- 3 Tested to JESD22-C101-A
- 4 Tested to EIA/JESD78

RECOMMENDED OPERATING CONDITIONS

| Symbol | Characteristics | Min | Max | Unit |
|---------------------------------|--|-----|--|---------|
| V _{CC} | DC Supply Voltage | 2.0 | 5.5 | V |
| V _{IN} | DC Input Voltage | 0 | 5.5 | V |
| V _{OUT} | DC Output Voltage | 0 | V _{CC} | V |
| T _A | Operating Temperature Range, all Package Types | -55 | 125 | °C |
| t _r , t _f | Input Rise or Fall Time | | | ns/V |
| | | | V _{CC} = 3.3 V ± 0.3 V V _{CC} = 5.0 V ± 0.5 V | 0 20 |

DEVICE JUNCTION TEMPERATURE VERSUS TIME TO 0.1% BOND FAILURES

| Junction Temperature °C | Time, Hours | Time, Years |
|-------------------------|-------------|-------------|
| 80 | 1,032,200 | 117.8 |
| 90 | 419,300 | 47.9 |
| 100 | 178,700 | 20.4 |
| 110 | 79,600 | 9.4 |
| 120 | 37,000 | 4.2 |
| 130 | 17,800 | 2.0 |
| 140 | 8,900 | 1.0 |

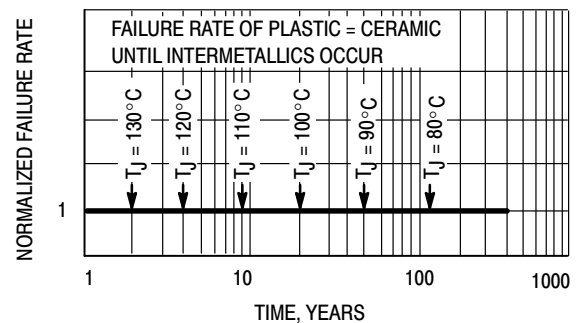

Figure 4. Failure Rate vs. Time Junction Temperature

MC74VHC257

DC CHARACTERISTICS (Voltages Referenced to GND)

| Symbol | Parameter | Condition | V _{CC} (V) | T _A = 25°C | | | T _A ≤ 85°C | | -55°C ≤ T _A ≤ 125°C | | Unit |
|-----------------|--|--|------------------------|--------------------------------|-------------------|--------------------------------|--------------------------------|--------------------------------|--------------------------------|--------------------------------|------|
| | | | | Min | Typ | Max | Min | Max | Min | Max | |
| V _{IH} | Minimum High-Level Input Voltage | | 2.0 3.0 to 5.5 | 1.5 V _{CCX} 0.7 | | | 1.5 V _{CCX} 0.7 | 1.5 V _{CCX} 0.7 | 1.5 V _{CCX} 0.7 | | V |
| V _{IL} | Maximum Low-Level Input Voltage | | 2.0 3.0 to 5.5 | | | 0.5 V _{CCX} 0.3 | | 0.5 V _{CCX} 0.3 | | 0.5 V _{CCX} 0.3 | V |
| V _{OH} | Maximum High-Level Output Voltage | V _{IN} = V _{IH} or V _{IL} I _{OH} = -50 μA | 2.0 3.0 4.5 | 1.9 2.9 4.4 | 2.0 3.0 4.5 | | 1.9 2.9 4.4 | | 1.9 2.9 4.4 | | V |
| | | V _{IN} = V _{IH} or V _{IL} I _{OH} = -4 mA I _{OH} = -8 mA | 3.0 4.5 | 2.58 3.94 | | | 2.48 3.8 | | 2.34 3.66 | | |
| V _{OL} | Maximum Low-Level Output Voltage | V _{IN} = V _{IH} or V _{IL} I _{OL} = 50 μA | 2.0 3.0 4.5 | | 0.0 0.0 0.0 | 0.1 0.1 0.1 | | 0.1 0.1 0.1 | | 0.1 0.1 0.1 | V |
| | | V _{IN} = V _{IH} or V _{IL} I _{OH} = 4 mA I _{OH} = 8 mA | 3.0 4.5 | | | 0.36 0.36 | | 0.44 0.44 | | 0.52 0.52 | |
| I _{IN} | Input Leakage Current | V _{IN} = 5.5 V or GND | 0 to 5.5 | | | ±0.1 | | ±1.0 | | ±1.0 | μA |
| I _{OZ} | Maximum 3-State Leakage Current | V _{IN} = V _{IH} or V _{IL} V _{OUT} = V _{CC} or GND | 5.5 | | | ±0.25 | | ±2.5 | | ±2.5 | μA |
| I _{CC} | Maximum Quiescent Supply Current (per package) | V _{IN} = V _{CC} or GND | 5.5 | | | 4.0 | | 40.0 | | 40.0 | μA |

AC ELECTRICAL CHARACTERISTICS (Input t_r = t_f = 3.0ns)

| Symbol | Parameter | Test Conditions | T _A = 25°C | | | T _A = ≤ 85°C | | -55°C ≤ T _A ≤ 125°C | | Unit |
|--|--|--|-----------------------|------|------|-------------------------|------|--------------------------------|------|------|
| | | | Min | Typ | Max | Min | Max | Min | Max | |
| t _{PLH} , t _{PHL} | Maximum Propagation Delay A or B to Y | V _{CC} = 3.3 ± 0.3 V C _L = 15 pF | | 5.8 | 9.3 | 1.0 | 11.0 | 1.0 | 11.0 | ns |
| | | C _L = 50 pF | | 8.3 | 12.8 | 1.0 | 14.5 | 1.0 | 14.5 | |
| | | V _{CC} = 5.0 ± 0.5 V C _L = 15 pF | | 3.6 | 5.9 | 1.0 | 7.0 | 1.0 | 7.0 | |
| | | C _L = 50 pF | | 5.1 | 7.9 | 1.0 | 9.0 | 1.0 | 9.0 | |
| t _{PLH} , t _{PHL} | Maximum Propagation Delay S to Y | V _{CC} = 3.3 ± 0.3 V C _L = 15 pF | | 7.0 | 11.0 | 1.0 | 13.0 | 1.0 | 13.0 | ns |
| | | C _L = 50 pF | | 9.5 | 14.5 | 1.0 | 16.5 | 1.0 | 16.5 | |
| | | V _{CC} = 5.0 ± 0.5 V C _L = 15 pF | | 4.0 | 6.8 | 1.0 | 8.0 | 1.0 | 8.0 | |
| | | C _L = 50 pF | | 5.5 | 8.8 | 1.0 | 10.0 | 1.0 | 10.0 | |
| t _{PZL} , t _{PZH} | Maximum Output Enable Time OE to Y | V _{CC} = 3.3 ± 0.3 V C _L = 15 pF | | 6.7 | 10.5 | 1.0 | 12.5 | 1.0 | 12.5 | ns |
| | | R _L = 1 kΩ C _L = 50 pF | | 9.2 | 14.0 | 1.0 | 16.0 | 1.0 | 16.0 | |
| | | V _{CC} = 5.0 ± 0.5 V C _L = 15 pF | | 3.6 | 6.8 | 1.0 | 8.0 | 1.0 | 8.0 | |
| | | R _L = 1 kΩ C _L = 50 pF | | 5.1 | 8.8 | 1.0 | 10.0 | 1.0 | 10.0 | |
| t _{PLZ} , t _{PHZ} | Maximum Output Disable Time OE to Y | V _{CC} = 3.3 ± 0.3 V C _L = 50 pF | | 12.0 | 15.0 | 1.0 | 16.0 | 1.0 | 17.5 | ns |
| | | R _L = 1 kΩ | | | | | | | | |
| | | V _{CC} = 5.0 ± 0.5 V C _L = 50 pF | | 5.7 | 13.0 | 1.0 | 14.0 | 1.0 | 15.0 | |
| | | R _L = 1 kΩ | | | | | | | | |
| C _{IN} | Maximum Input Capacitance | | | 4 | 10 | | 10 | | 10 | pF |

| | | | |
|-----------------|--|--|--|
| C _{PD} | Power Dissipation Capacitance (Note 5) | Typical @ 25°C, V _{CC} = 5.0V | |
| | | 20 | |
| | | pF | |

5. C_{PD} is defined as the value of the internal equivalent capacitance which is calculated from the operating current consumption without load. Average operating current can be obtained by the equation: I_{CC(OPR)} = C_{PD} • V_{CC} • f_{in} + I_{CC}. C_{PD} is used to determine the no-load dynamic power consumption; P_D = C_{PD} • V_{CC}² • f_{in} + I_{CC} • V_{CC}.

MC74VHC257

NOISE CHARACTERISTICS (Input $t_r = t_f = 3.0$ ns, $C_L = 50$ pF, $V_{CC} = 5.0$ V)

| Symbol | Characteristic | $T_A = 25^\circ\text{C}$ | | Unit |
|-----------|--|--------------------------|------|------|
| | | Typ | Max | |
| V_{OLP} | Quiet Output Maximum Dynamic V_{OL} | 0.3 | 0.8 | V |
| V_{OLV} | Quiet Output Minimum Dynamic V_{OL} | -0.3 | -0.8 | V |
| V_{IHD} | Minimum High Level Dynamic Input Voltage | | 3.5 | V |
| V_{ILD} | Maximum Low Level Dynamic Input Voltage | | 1.5 | V |

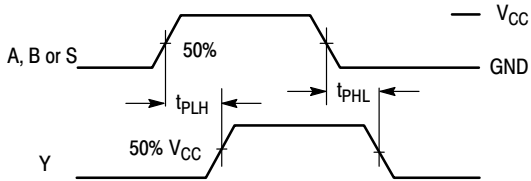

Figure 5. Switching Waveform

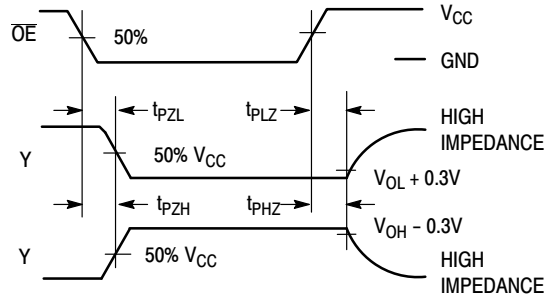
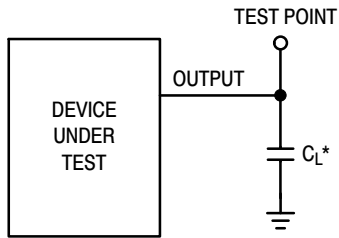
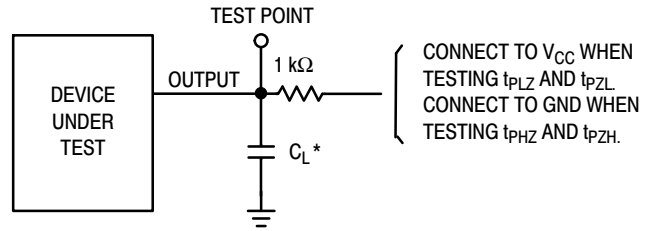

Figure 6. Switching Waveform



*Includes all probe and jig capacitance

Figure 7. Test Circuit



*Includes all probe and jig capacitance

Figure 8. Test Circuit

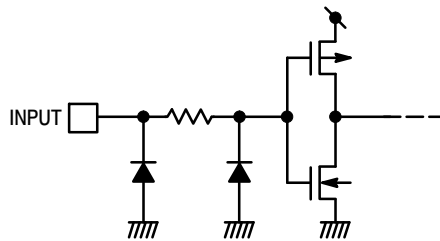
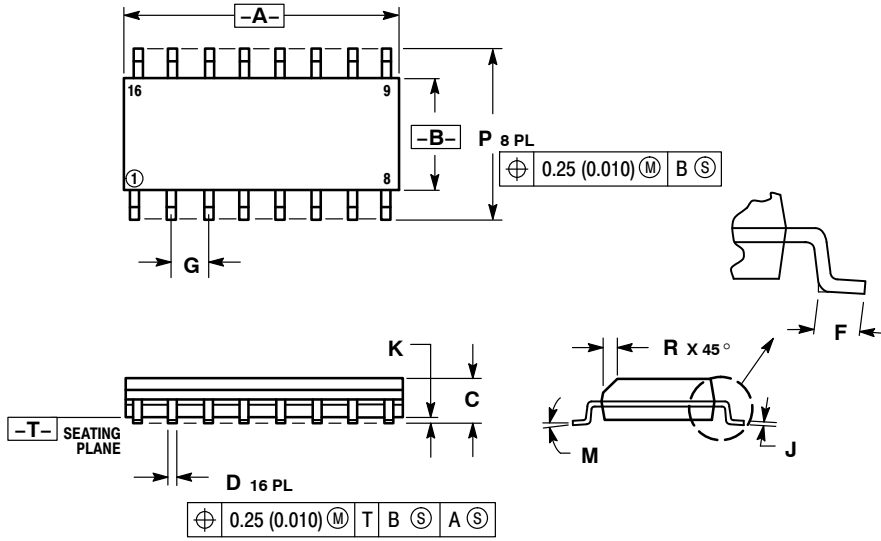

Figure 9. Input Equivalent Circuit

MC74VHC257

PACKAGE DIMENSIONS

SOIC-16
CASE 751B-05
ISSUE K



NOTES:

1. DIMENSIONING AND TOLERANCING PER ANSI Y14.5M, 1982.
2. CONTROLLING DIMENSION: MILLIMETER.
3. DIMENSIONS A AND B DO NOT INCLUDE MOLD PROTRUSION.
4. MAXIMUM MOLD PROTRUSION 0.15 (0.006) PER SIDE.
5. DIMENSION D DOES NOT INCLUDE DAMBAR PROTRUSION. ALLOWABLE DAMBAR PROTRUSION SHALL BE 0.127 (0.005) TOTAL IN EXCESS OF THE D DIMENSION AT MAXIMUM MATERIAL CONDITION.

| DIM | MILLIMETERS | | INCHES | |
|-----|-------------|-------|-----------|-------|
| | MIN | MAX | MIN | MAX |
| A | 9.80 | 10.00 | 0.386 | 0.393 |
| B | 3.80 | 4.00 | 0.150 | 0.157 |
| C | 1.35 | 1.75 | 0.054 | 0.068 |
| D | 0.35 | 0.49 | 0.014 | 0.019 |
| F | 0.40 | 1.25 | 0.016 | 0.049 |
| G | 1.27 BSC | | 0.050 BSC | |
| J | 0.19 | 0.25 | 0.008 | 0.009 |
| K | 0.10 | 0.25 | 0.004 | 0.009 |
| M | 0° | 7° | 0° | 7° |
| P | 5.80 | 6.20 | 0.229 | 0.244 |
| R | 0.25 | 0.50 | 0.010 | 0.019 |

SOLDERING FOOTPRINT

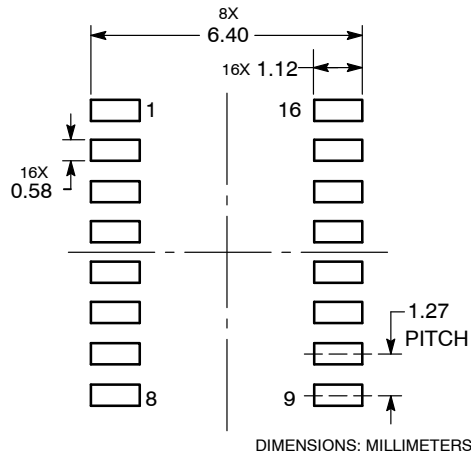

MC74VHC257

PACKAGE DIMENSIONS

TSSOP-16
CASE 948F-01
ISSUE B

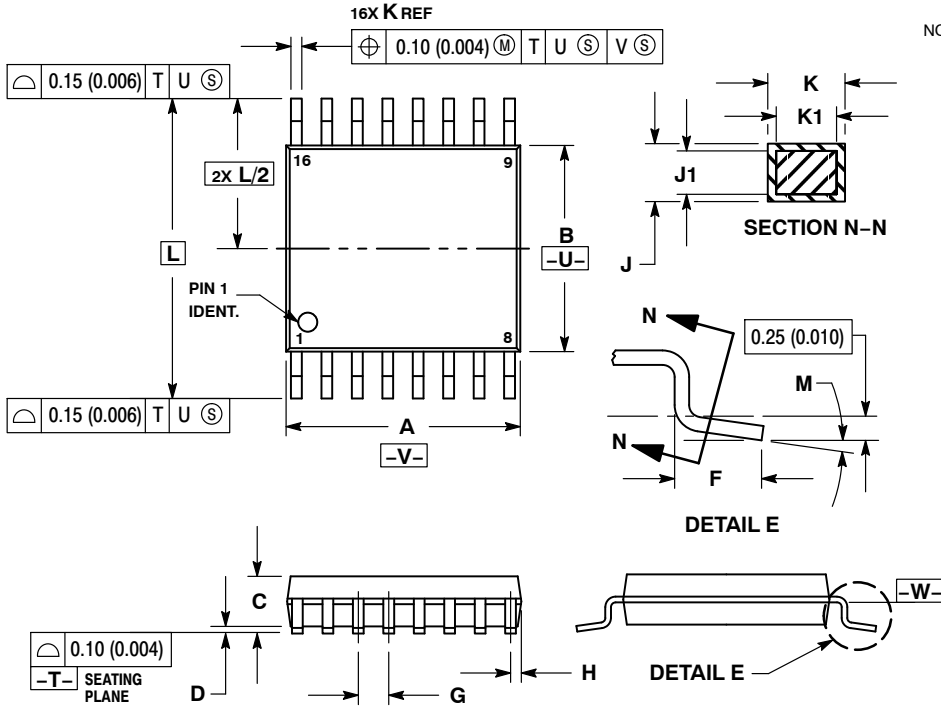

- NOTES:
1. DIMENSIONING AND TOLERANCING PER ANSI Y14.5M, 1982.
 2. CONTROLLING DIMENSION: MILLIMETER.
 3. DIMENSION A DOES NOT INCLUDE MOLD FLASH. PROTRUSIONS OR GATE BURRS. MOLD FLASH OR GATE BURRS SHALL NOT EXCEED 0.15 (0.006) PER SIDE.
 4. DIMENSION B DOES NOT INCLUDE INTERLEAD FLASH OR PROTRUSION. INTERLEAD FLASH OR PROTRUSION SHALL NOT EXCEED 0.25 (0.010) PER SIDE.
 5. DIMENSION K DOES NOT INCLUDE DAMBAR PROTRUSION. ALLOWABLE DAMBAR PROTRUSION SHALL BE 0.08 (0.003) TOTAL IN EXCESS OF THE K DIMENSION AT MAXIMUM MATERIAL CONDITION.
 6. TERMINAL NUMBERS ARE SHOWN FOR REFERENCE ONLY.
 7. DIMENSION A AND B ARE TO BE DETERMINED AT DATUM PLANE -W-.

| DIM | MILLIMETERS | | INCHES | |
|-----|-------------|------|-----------|-------|
| | MIN | MAX | MIN | MAX |
| A | 4.90 | 5.10 | 0.193 | 0.200 |
| B | 4.30 | 4.50 | 0.169 | 0.177 |
| C | --- | 1.20 | --- | 0.047 |
| D | 0.05 | 0.15 | 0.002 | 0.006 |
| F | 0.50 | 0.75 | 0.020 | 0.030 |
| G | 0.65 BSC | | 0.026 BSC | |
| H | 0.18 | 0.28 | 0.007 | 0.011 |
| J | 0.09 | 0.20 | 0.004 | 0.008 |
| J1 | 0.09 | 0.16 | 0.004 | 0.006 |
| K | 0.19 | 0.30 | 0.007 | 0.012 |
| K1 | 0.19 | 0.25 | 0.007 | 0.010 |
| L | 6.40 BSC | | 0.252 BSC | |
| M | 0° | 8° | 0° | 8° |

SOLDERING FOOTPRINT

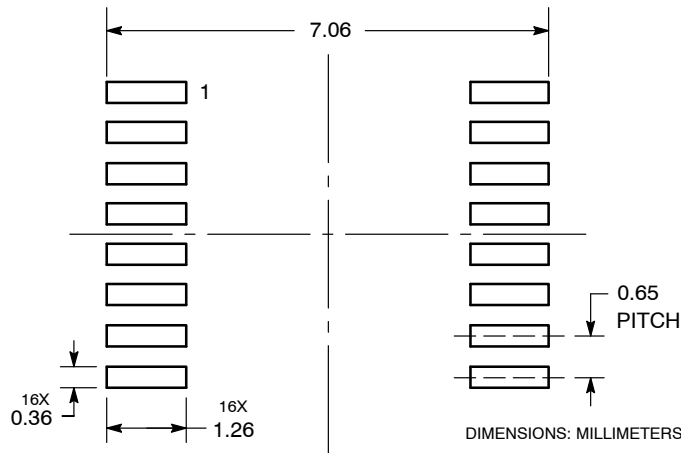

MC74VHC257

PACKAGE DIMENSIONS

SOEIAJ-16
CASE 966-01
ISSUE A

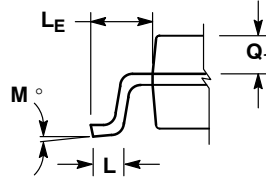
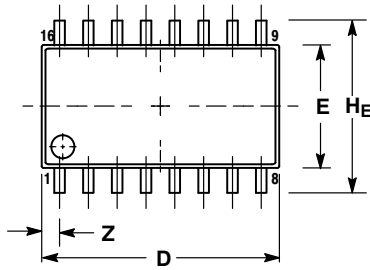

DETAIL P

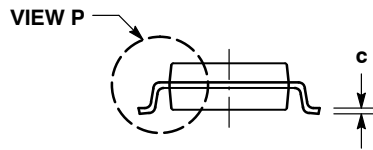
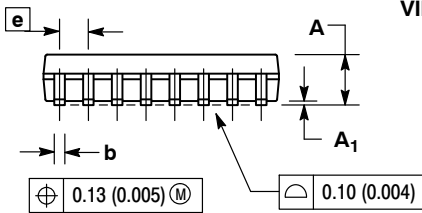

NOTES:

1. DIMENSIONING AND TOLERANCING PER ANSI Y14.5M, 1982.
2. CONTROLLING DIMENSION: MILLIMETER.
3. DIMENSIONS D AND E DO NOT INCLUDE MOLD FLASH OR PROTRUSIONS AND ARE MEASURED AT THE PARTING LINE. MOLD FLASH OR PROTRUSIONS SHALL NOT EXCEED 0.15 (0.006) PER SIDE.
4. TERMINAL NUMBERS ARE SHOWN FOR REFERENCE ONLY.
5. THE LEAD WIDTH DIMENSION (b) DOES NOT INCLUDE DAMBAR PROTRUSION. ALLOWABLE DAMBAR PROTRUSION SHALL BE 0.08 (0.003) TOTAL IN EXCESS OF THE LEAD WIDTH DIMENSION AT MAXIMUM MATERIAL CONDITION. DAMBAR CANNOT BE LOCATED ON THE LOWER RADIUS OR THE FOOT. MINIMUM SPACE BETWEEN PROTRUSIONS AND ADJACENT LEAD TO BE 0.46 (0.018).

| DIM | MILLIMETERS | | INCHES | |
|----------------|-------------|-------|-----------|-------|
| | MIN | MAX | MIN | MAX |
| A | --- | 2.05 | --- | 0.081 |
| A ₁ | 0.05 | 0.20 | 0.002 | 0.008 |
| b | 0.35 | 0.50 | 0.014 | 0.020 |
| c | 0.10 | 0.20 | 0.007 | 0.011 |
| D | 9.90 | 10.50 | 0.390 | 0.413 |
| E | 5.10 | 5.45 | 0.201 | 0.215 |
| e | 1.27 BSC | | 0.050 BSC | |
| H _E | 7.40 | 8.20 | 0.291 | 0.323 |
| L | 0.50 | 0.85 | 0.020 | 0.033 |
| L _E | 1.10 | 1.50 | 0.043 | 0.059 |
| M | 0° | 10° | 0° | 10° |
| Q ₁ | 0.70 | 0.90 | 0.028 | 0.035 |
| Z | --- | 0.78 | --- | 0.031 |

ON Semiconductor and are registered trademarks of Semiconductor Components Industries, LLC (SCILLC). SCILLC reserves the right to make changes without further notice to any products herein. SCILLC makes no warranty, representation or guarantee regarding the suitability of its products for any particular purpose, nor does SCILLC assume any liability arising out of the application or use of any product or circuit, and specifically disclaims any and all liability, including without limitation special, consequential or incidental damages. "Typical" parameters which may be provided in SCILLC data sheets and/or specifications can and do vary in different applications and actual performance may vary over time. All operating parameters, including "Typicals" must be validated for each customer application by customer's technical experts. SCILLC does not convey any license under its patent rights nor the rights of others. SCILLC products are not designed, intended, or authorized for use as components in systems intended for surgical implant into the body, or other applications intended to support or sustain life, or for any other application in which the failure of the SCILLC product could create a situation where personal injury or death may occur. Should Buyer purchase or use SCILLC products for any such unintended or unauthorized application, Buyer shall indemnify and hold SCILLC and its officers, employees, subsidiaries, affiliates, and distributors harmless against all claims, costs, damages, and expenses, and reasonable attorney fees arising out of, directly or indirectly, any claim of personal injury or death associated with such unintended or unauthorized use, even if such claim alleges that SCILLC was negligent regarding the design or manufacture of the part. SCILLC is an Equal Opportunity/Affirmative Action Employer. This literature is subject to all applicable copyright laws and is not for resale in any manner.

PUBLICATION ORDERING INFORMATION

LITERATURE FULFILLMENT:
Literature Distribution Center for ON Semiconductor
P.O. Box 5163, Denver, Colorado 80217 USA
Phone: 303-675-2175 or 800-344-3860 Toll Free USA/Canada
Fax: 303-675-2176 or 800-344-3867 Toll Free USA/Canada
Email: orderlit@onsemi.com

N. American Technical Support: 800-282-9855 Toll Free
USA/Canada
Europe, Middle East and Africa Technical Support:
Phone: 421 33 790 2910
Japan Customer Focus Center
Phone: 81-3-5773-3850

ON Semiconductor Website: www.onsemi.com
Order Literature: <http://www.onsemi.com/orderlit>
For additional information, please contact your local Sales Representative

Компания «Life Electronics» занимается поставками электронных компонентов импортного и отечественного производства от производителей и со складов крупных дистрибьюторов Европы, Америки и Азии.

С конца 2013 года компания активно расширяет линейку поставок компонентов по направлению коаксиальный кабель, кварцевые генераторы и конденсаторы (керамические, пленочные, электролитические), за счёт заключения дистрибьюторских договоров

Мы предлагаем:

- Конкурентоспособные цены и скидки постоянным клиентам.
- Специальные условия для постоянных клиентов.
- Подбор аналогов.
- Поставку компонентов в любых объемах, удовлетворяющих вашим потребностям.
- Приемлемые сроки поставки, возможна ускоренная поставка.
- Доставку товара в любую точку России и стран СНГ.
- Комплексную поставку.
- Работу по проектам и поставку образцов.
- Формирование склада под заказчика.
- Сертификаты соответствия на поставляемую продукцию (по желанию клиента).
- Тестирование поставляемой продукции.
- Поставку компонентов, требующих военную и космическую приемку.
- Входной контроль качества.
- Наличие сертификата ISO.

В составе нашей компании организован Конструкторский отдел, призванный помогать разработчикам, и инженерам.

Конструкторский отдел помогает осуществить:

- Регистрацию проекта у производителя компонентов.
- Техническую поддержку проекта.
- Защиту от снятия компонента с производства.
- Оценку стоимости проекта по компонентам.
- Изготовление тестовой платы монтаж и пусконаладочные работы.



Тел: +7 (812) 336 43 04 (многоканальный)

Email: org@lifeelectronics.ru