

# PT8510

## Cable Actuated Sensor Heavy Industrial • 0...5, 0...10 Vdc

**Absolute Linear Position to 60 inches (1524 mm)**

**Aluminum or Stainless Steel Enclosure Options**

**VLS Option to Prevent Free-Release Damage**

**IP68 • NEMA 6 Protection**

### General

<b>Full Stroke Range</b>	0-2 to 0-60 inches
<b>Options</b>	
<b>Output Signal</b>	0...5, 0...10, -5...+5, -10...+10 VDC
<b>Accuracy</b>	± 1.00% to ± 0.15% full stroke (see ordering information)
<b>Repeatability</b>	± 0.05% full stroke
<b>Resolution</b>	essentially infinite
<b>Measuring Cable</b>	nylon-coated stainless steel or thermoplastic
<b>Enclosure Material</b>	powder-painted aluminum or stainless steel
<b>Sensor</b>	plastic-hybrid precision potentiometer
<b>Potentiometer Cycle Life</b>	see ordering information
<b>Maximum Retraction</b>	see ordering information
<b>Acceleration</b>	
<b>Weight</b>	3 lbs. (6 lbs.) max.

The PT8510 can operate from an unregulated 14.5 to 40 VDC power supply while providing an output signal that is proportional to the linear movement of its measuring cable. The PT8510 has a maximum measurement range up to 60" and has 4 output signal options to choose from: 0...10, 0...5, -10...+10 and -5...+5 Vdc.

As a member of our innovative family of NEMA-4 rated cable-extension transducers, the PT8510 offers numerous benefits. It installs in minutes, fits into areas unsuited for rod-type measurement devices, and works without perfectly parallel alignment.

### Output Signal

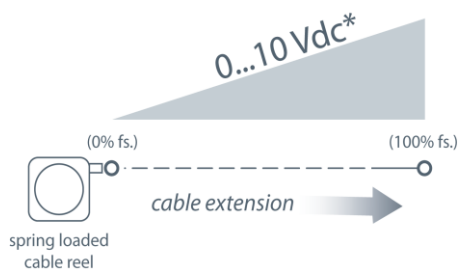

*\*Also Available: 0...5, -5...+5, -10...+10 Vdc*

### Electrical

<b>Input Voltage</b>	see ordering information
<b>Input Current</b>	10 mA maximum
<b>Output Impedance</b>	1000 ohms
<b>Maximum Load</b>	5000 ohms
<b>Zero and Span Adjustment</b>	see ordering information

### Environmental

<b>Enclosure</b>	NEMA 4/4X/6, IP 67/68
<b>Operating Temperature</b>	-40° to 200°F (-40° to 90°C)
<b>Vibration</b>	up to 10 g to 2000 Hz maximum

**PT8510**

Heavy Industrial • 0...5, 0...10 Vdc

Outline Drawing:

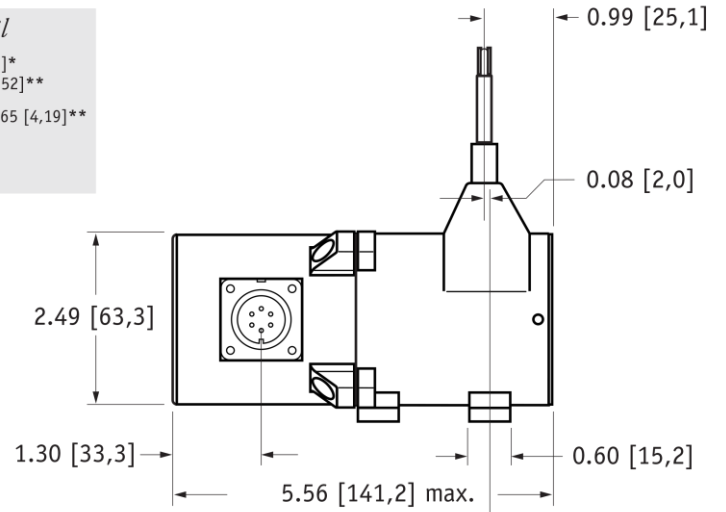
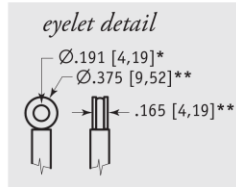
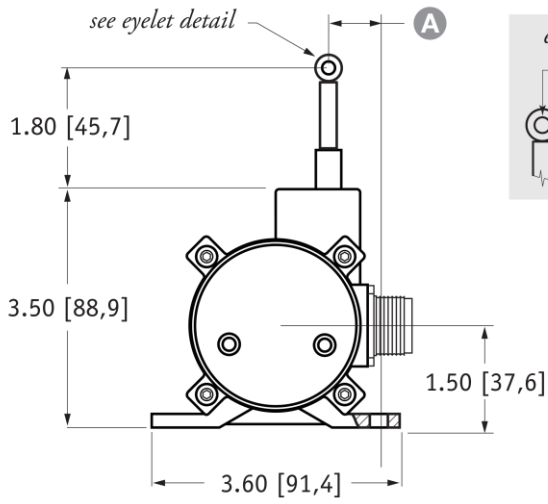

RANGE		A
2", 10"	1.16 [29,5]	
5", 25", 50"	0.66 [16,8]	
15"	0.99 [25,7]	
20", 40"	0.85 [21,6]	
30", 60"	0.52 [13,3]	

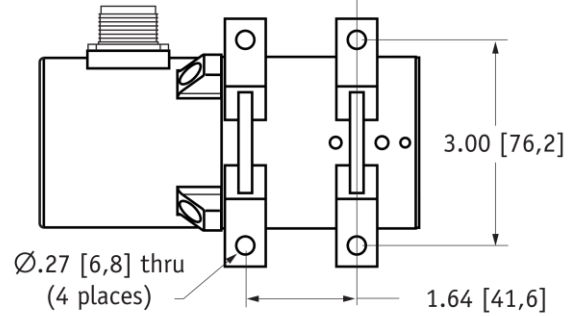

DIMENSIONS ARE IN INCHES [MM]  
 tolerances are ±0.02 in. [±0,5 mm] unless otherwise noted  
 note: \*tolerance = +.005 -.001 [+,.13 -.03]    \*\*tolerance = +.005 -.005 [+,.13 -.13]

# PT8510

Heavy Industrial • 0...5, 0...10 Vdc

## Ordering Information

### Model Number:

**PT8510-** \_\_\_\_\_ **1** - **1** \_\_\_\_\_  
order code:                      R                      A                      B                      C                      D                      E                      F                      G

Sample Model Number:

**PT8510 - 0030 - 111 - 1110**

- R** range: 30 inches
- A** enclosure/cable tension: aluminum/standard (9 oz.)
- B** measuring cable: .034 nylon-coated stainless
- E** output signal: 0...10 vdc
- F** electrical connection: 6-pin plastic connector
- G** cable guide option: standard nylon cable guide

### Full Stroke Range:

<b>R</b> order code:	0002	0005	0010	0015	0020	0025	0030	0040	0050	0060
full stroke range, min:	2 in.	5 in.	10 in.	15 in.	20 in.	25 in.	30 in.	40 in.	50 in.	60 in.
accuracy (% of f.s.):	1.00%	1.00%	0.18%	0.18%	0.18%	0.18%	0.18%	0.15%	0.15%	0.15%
potentiometer cycle life*:	2.5 x 10 <sup>6</sup>	2.5 x 10 <sup>6</sup>	5 x 10 <sup>5</sup>	5 x 10 <sup>5</sup>	5 x 10 <sup>5</sup>	5 x 10 <sup>5</sup>	5 x 10 <sup>5</sup>	2.5 x 10 <sup>5</sup>	2.5 x 10 <sup>5</sup>	2.5 x 10 <sup>5</sup>

\*-1 cycle is defined as the travel of the measuring cable from full retraction to full extension and back to full retraction

### Enclosure Material and Measuring Cable Tension:

<b>A</b> order code:	1	5	2	3	6	4	8	7	9
enclosure:	aluminum			303 stainless			316 stainless		
cable tension:	standard	medium	high	standard	medium	high	standard	medium	high
max. acceleration:	15 g	25 g	40 g	6 g	12 g	18 g	6 g	12 g	18 g

cable tension option specifications	Range:	2 in.	5 in.	10 in.	15 in.	20 in.	25 in.	30 in.	40 in.	50 in.	60 in.
	Standard:	39 oz.	16 oz.	39 oz.	26 oz.	20 oz.	16 oz.	13 oz.	20 oz.	16 oz.	13 oz.
	Medium:	65 oz.	26 oz.	65 oz.	43 oz.	33 oz.	26 oz.	22 oz.	33 oz.	26 oz.	22 oz.
	High:	116 oz.	47 oz.	116 oz.	77 oz.	60 oz.	47 oz.	40 oz.	60 oz.	47 oz.	40 oz.

tension tolerance: ± 50%

### Measuring Cable:

<b>B</b> order code:	1	2	3	4
cable construction:	Ø.034-inch nylon-coated stainless steel rope	Ø.047-inch bare stainless steel rope	Ø.058-inch PVC jacketed vectra fiber rope	Ø.031-inch bare stainless steel rope
available ranges:	all ranges	5, 15, 20, 25, 30-inch only	thru 30 inches only	40, 50, 60-inch only
general use:	indoor	outdoor, debris, high temperature	high voltage or magnetic field	outdoor, debris, high temperature

### Output Signals:



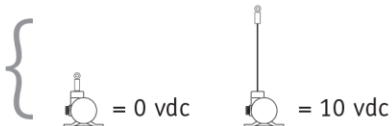

<b>F</b> order code:	1	2	3	4	5	6	7	8
output signal options:	0...10 VDC	10...0 VDC	0...5 VDC	5...0 VDC	-10...+10 VDC	+10...-10 VDC	-5...+5 VDC	+5...-5 VDC
input voltage:	14.5 - 40 vdc		10.5 - 40 vdc		14.5 - 40 vdc		10.5 - 40 vdc	
span adjustment:	to 50% of factory set span				to 75% of factory set span			
zero adjustment:	from factory set zero to 50% of full stroke range				from factory set zero to 25% of full stroke range			

Example:

ordercode = **1** = 0...10 vdc

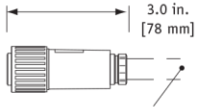
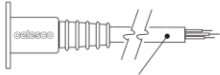
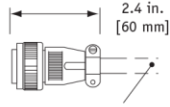

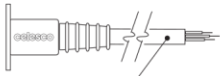
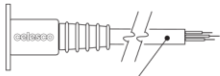
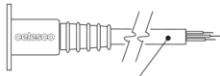
**Electrical Connection:**

<p><b>F</b> <i>order code:</i> <b>1</b></p> <p>6-pin plastic connector w/mating plug <b>IP 67, NEMA 4X**,6</b></p>  <p>1/2 - 5/16" [14 - 8 mm] cable dia. 16 AWG max conductor size connector: MS3102E-14S-6P mating plug: MS3106E-14S-6S</p>	<p><b>2</b></p> <p>10-ft. [3 M] waterproof cable <b>IP 67, NEMA 4X**, 6</b></p>  <p>10 ft. x 0.4-in. dia. [3 M x 10 mm dia.] 3-conductor, 18 AWG type SJTOW</p>	<p><b>3</b></p> <p>6-pin metal connector w/mating plug <b>IP 65, NEMA 4</b></p>  <p>3/8-in. [9 mm] max cable dia. 16 AWG max conductor size connector: MS3102E-14S-6P mating plug: MS3106E-14S-6S</p>	<p><b>4</b></p> <p>25-ft. [7.5 M] instrumentation cable <b>IP 67, NEMA 6</b></p>  <p>25 ft. x 0.2-in. dia. [7.5 M x 5 mm dia.] 6-conductor, 24 AWG shielded</p>																								
<p><b>F</b> <i>order code:</i> <b>5</b></p> <p>100-ft. [30 M] waterproof cable <b>IP 67, NEMA 4X**,6</b></p>  <p>100 ft. x 0.4-in. dia. [30 M x 10 mm dia.] 18 AWG, type SJTOW</p>	<p><b>6</b></p> <p>10-ft. [3 M] <b>pressure tested*</b> waterproof cable <b>IP 68, NEMA 4X**, 6P</b></p>  <p>10 ft. x 0.4-in. dia. [3 M x 10 mm dia.] 3-conductor, 18 AWG type SJTOW</p>	<p><b>7</b></p> <p>100-ft. [30 M] <b>pressure tested*</b> waterproof cable <b>IP 68, NEMA 4X**, 6P</b></p>  <p>100 ft. x 0.4-in. dia. [30 M x 10 mm dia.] 3-conductor, 18 AWG type SJTOW</p>																									
<p><b>6-pin Mating Plug</b></p> <table border="1"> <tr> <th>pin</th> <th>signal</th> </tr> <tr> <td>A</td> <td>input voltage</td> </tr> <tr> <td>B</td> <td>output signal</td> </tr> <tr> <td>C</td> <td>common</td> </tr> </table>  <p><i>contact view</i></p>	pin	signal	A	input voltage	B	output signal	C	common	<p><b>Waterproof Cable</b></p> <table border="1"> <tr> <th>color code</th> <th>signal</th> </tr> <tr> <td>WHITE</td> <td>input voltage</td> </tr> <tr> <td>GREEN</td> <td>output signal</td> </tr> <tr> <td>BLACK</td> <td>common</td> </tr> </table>	color code	signal	WHITE	input voltage	GREEN	output signal	BLACK	common	<p><b>Instrumentation Cable</b></p> <table border="1"> <tr> <th>color code</th> <th>signal</th> </tr> <tr> <td>RED</td> <td>input voltage</td> </tr> <tr> <td>GREEN</td> <td>output signal</td> </tr> <tr> <td>BLACK</td> <td>common</td> </tr> </table> <p><i>Note: WHITE, BLUE, BROWN are not used.</i></p>	color code	signal	RED	input voltage	GREEN	output signal	BLACK	common	
pin	signal																										
A	input voltage																										
B	output signal																										
C	common																										
color code	signal																										
WHITE	input voltage																										
GREEN	output signal																										
BLACK	common																										
color code	signal																										
RED	input voltage																										
GREEN	output signal																										
BLACK	common																										

\*-Test pressure: 100 feet [30 meters] H<sub>2</sub>O (40 PSID); Test Medium: Air; Duration: 2 hours. \*\*-Applies to stainless steel enclosure only.

**Cable Guide Options:**

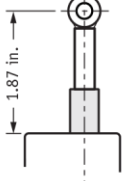
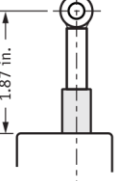
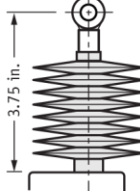
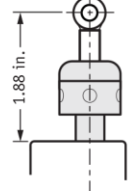
<p><b>G</b> <i>order code:</i> <b>0</b></p> <p>standard cable guide</p>  <p>1.87 in.</p>	<p><b>1</b></p> <p>stainless steel cable guide</p>  <p>1.87 in.</p>	<p><b>2*</b></p> <p>polyurethane cable bellows</p>  <p>3.75 in.</p>	<p><b>3</b></p> <p>integral cable brush</p>  <p>1.88 in.</p>
---	--	--	---

\*note: all ranges up to 25 inches only

**Output Signal Selection (does not apply to -5...+5 and -10...+10 VDC options)**

The output signal direction can be reversed at any time by simply changing the dip-switch settings found on the internal signal board. After the settings have been changed, adjustment of the Zero and Span trim pots will be required to precisely match signal values to the beginning and end points of the stroke.

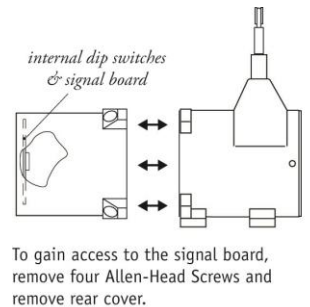
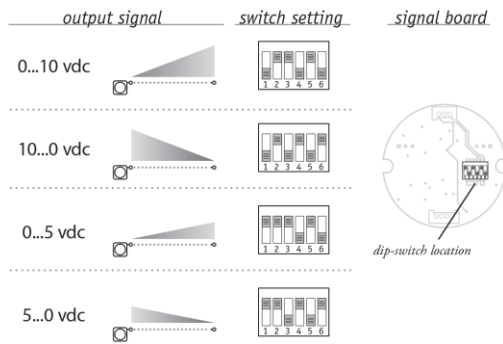

**VLS Option - Free Release Protection**

The patented Celesco Velocity Limiting System (VLS) is an option for PT8000 Series cable extension transducers that limits cable retraction to a safe 40 to 55 inches per second.

The VLS option prevents the measuring cable from ever reaching a damaging velocity during an accidental free release. This option is ideal for mobile applications that require frequent cable disconnection and reconnection. It prevents expensive unscheduled downtime due to accidental cable mishandling or attachment failure.

VLS is NOT available for medium and high cable tension options or 2, 5 and 15-inch stroke ranges.

**How to Configure Model Number for VLS**

VLS8510-	-	1	-	1	-	1	0
0015		1		1		1	0
0020		2		2		2	1
0025		3		3		3	3
0030		4		4		4	4
0040				5		5	5
0050				6		6	6
0060				7		7	7
				8			

■ = available options\*\*

creating VLS model number (example):

1. select PT8420 model **PT8510-0060-111-1110**
2. remove "PT" from the model number **8510-0060-111-1110**
3. add "VLS" **VLS + 8510-0060-111-1110**
4. completed model number! **VLS8510-0060-111-1110**

\*\*Note: please contact factory for a solution to options not supported.

**NORTH AMERICA**

Measurement Specialties, Inc.,  
 a TE Connectivity company  
 20630 Plummer Street  
 Chatsworth, CA 91311  
 Tel +1 800 423 5483  
 Tel +1 818 701 2750  
 Fax +1 818 701 2799  
 info@celesco.com

**TE.com/sensorsolutions**

Measurement Specialties, Inc., a TE Connectivity company.

Measurement Specialties, TE Connectivity, TE Connectivity (logo) and EVERY CONNECTION COUNTS are trademarks. All other logos, products and/or company names referred to herein might be trademarks of their respective owners.

The information given herein, including drawings, illustrations and schematics which are intended for illustration purposes only, is believed to be reliable. However, TE Connectivity makes no warranties as to its accuracy or completeness and disclaims any liability in connection with its use. TE Connectivity's obligations shall only be as set forth in TE Connectivity's Standard Terms and Conditions of Sale for this product and in no case will TE Connectivity be liable for any incidental, indirect or consequential damages arising out of the sale, resale, use or misuse of the product. Users of TE Connectivity products should make their own evaluation to determine the suitability of each such product for the specific application.

© 2015 TE Connectivity Ltd. family of companies All Rights Reserved.

PT8510 12/01/2015

Компания «Life Electronics» занимается поставками электронных компонентов импортного и отечественного производства от производителей и со складов крупных дистрибьюторов Европы, Америки и Азии.

С конца 2013 года компания активно расширяет линейку поставок компонентов по направлению коаксиальный кабель, кварцевые генераторы и конденсаторы (керамические, пленочные, электролитические), за счёт заключения дистрибьюторских договоров

Мы предлагаем:

- Конкуренеспособные цены и скидки постоянным клиентам.
- Специальные условия для постоянных клиентов.
- Подбор аналогов.
- Поставку компонентов в любых объемах, удовлетворяющих вашим потребностям.
- Приемлемые сроки поставки, возможна ускоренная поставка.
- Доставку товара в любую точку России и стран СНГ.
- Комплексную поставку.
- Работу по проектам и поставку образцов.
- Формирование склада под заказчика.
- Сертификаты соответствия на поставляемую продукцию (по желанию клиента).
- Тестирование поставляемой продукции.
- Поставку компонентов, требующих военную и космическую приемку.
- Входной контроль качества.
- Наличие сертификата ISO.

В составе нашей компании организован Конструкторский отдел, призванный помогать разработчикам, и инженерам.

Конструкторский отдел помогает осуществить:

- Регистрацию проекта у производителя компонентов.
- Техническую поддержку проекта.
- Защиту от снятия компонента с производства.
- Оценку стоимости проекта по компонентам.
- Изготовление тестовой платы монтаж и пусконаладочные работы.



Тел: +7 (812) 336 43 04 (многоканальный)

Email: [org@lifeelectronics.ru](mailto:org@lifeelectronics.ru)