

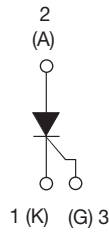

## Thyristor High Voltage, Phase Control SCR, 30 A

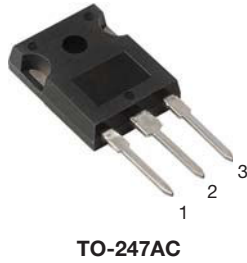

### FEATURES

- Designed and qualified according to JEDEC-JESD47
- 125 °C max. operating junction temperature
- Material categorization:  
For definitions of compliance please see [www.vishay.com/doc?99912](http://www.vishay.com/doc?99912)



**RoHS**  
COMPLIANT  
HALOGEN  
**FREE**  
Available

### APPLICATIONS

- Typical usage is in input rectification crowbar (soft start) and AC switch in motor control, UPS, welding and battery charge

### DESCRIPTION

The VS-30TPS... high voltage series of silicon controlled rectifiers are specifically designed for medium power switching and phase control applications. The glass passivation technology used has reliable operation up to 125 °C junction temperature.

PRODUCT SUMMARY	
Package	TO-247AC
Diode variation	Single SCR
$I_{T(AV)}$	20 A
$V_{DRM}/V_{RRM}$	800 V, 1200 V
$V_{TM}$	1.3 V
$I_{GT}$	45 mA
$T_J$	- 40 °C to 125 °C

MAJOR RATINGS AND CHARACTERISTICS			
PARAMETER	TEST CONDITIONS	VALUES	UNITS
$I_{T(AV)}$	Sinusoidal waveform	20	A
$I_{RMS}$		30	
$V_{RRM}/V_{DRM}$		800/1200	V
$I_{TSM}$		300	A
$V_T$	20 A, $T_J = 25\text{ °C}$	1.3	V
dV/dt		500	V/ $\mu$ s
dI/dt		150	A/ $\mu$ s
$T_J$		- 40 to 125	°C

VOLTAGE RATINGS			
PART NUMBER	$V_{RRM}/V_{DRM}$ , MAXIMUM REPETITIVE PEAK AND OFF-STATE VOLTAGE V	$V_{RSM}$ , MAXIMUM NON-REPETITIVE PEAK REVERSE VOLTAGE V	$I_{RRM}/I_{DRM}$ AT 125 °C mA
VS-30TPS08PbF, VS-30TPS08-M3	800	900	10
VS-30TPS12PbF, VS-30TPS12-M3	1200	1300	



ABSOLUTE MAXIMUM RATINGS					
PARAMETER	SYMBOL	TEST CONDITIONS	VALUES	UNITS	
Maximum average on-state current	$I_{T(AV)}$	$T_C = 95\text{ }^\circ\text{C}$ , 180° conduction half sine wave	20	A	
Maximum RMS on-state current	$I_{RMS}$		30		
Maximum peak, one-cycle non-repetitive surge current	$I_{TSM}$	10 ms sine pulse, rated $V_{RRM}$ applied	250		
		10 ms sine pulse, no voltage reapplied	300		
Maximum $I^2t$ for fusing	$I^2t$	10 ms sine pulse, rated $V_{RRM}$ applied	310	$A^2s$	
		10 ms sine pulse, no voltage reapplied	442		
Maximum $I^2\sqrt{t}$ for fusing	$I^2\sqrt{t}$	$t = 0.1$ to 10 ms, no voltage reapplied	4420	$A^2\sqrt{s}$	
Maximum on-state voltage drop	$V_{TM}$	20 A, $T_J = 25\text{ }^\circ\text{C}$	1.3	V	
On-state slope resistance	$r_t$	$T_J = 125\text{ }^\circ\text{C}$	12	$m\Omega$	
Threshold voltage	$V_{T(TO)}$		1.0	V	
Maximum reverse and direct leakage current	$I_{RM}/I_{DM}$	$T_J = 25\text{ }^\circ\text{C}$ $T_J = 125\text{ }^\circ\text{C}$	$V_R = \text{Rated } V_{RRM}/V_{DRM}$	0.5	mA
				10	
Maximum holding current	$I_H$	Anode supply = 6 V, resistive load, initial $I_T = 1$ A, $T_J = 25\text{ }^\circ\text{C}$	150		
Maximum latching current	$I_L$	Anode supply = 6 V, resistive load, $T_J = 25\text{ }^\circ\text{C}$	200		
Maximum rate of rise of off-state voltage	$dV/dt$	$T_J = T_J$ maximum, linear to 80 % $V_{DRM}$ , $R_g-k = \text{Open}$	500	V/ $\mu s$	
Maximum rate of rise of turned-on current	$dI/dt$		150	A/ $\mu s$	

TRIGGERING				
PARAMETER	SYMBOL	TEST CONDITIONS	VALUES	UNITS
Maximum peak gate power	$P_{GM}$		8.0	W
Maximum average gate power	$P_{G(AV)}$		2.0	
Maximum peak positive gate current	+ $I_{GM}$		1.5	A
Maximum peak negative gate voltage	- $V_{GM}$		10	V
Maximum required DC gate current to trigger	$I_{GT}$	Anode supply = 6 V, resistive load, $T_J = -10\text{ }^\circ\text{C}$	60	mA
		Anode supply = 6 V, resistive load, $T_J = 25\text{ }^\circ\text{C}$	45	
		Anode supply = 6 V, resistive load, $T_J = 125\text{ }^\circ\text{C}$	20	
Maximum required DC gate voltage to trigger	$V_{GT}$	Anode supply = 6 V, resistive load, $T_J = -10\text{ }^\circ\text{C}$	2.5	V
		Anode supply = 6 V, resistive load, $T_J = 25\text{ }^\circ\text{C}$	2.0	
		Anode supply = 6 V, resistive load, $T_J = 125\text{ }^\circ\text{C}$	1.0	
Maximum DC gate voltage not to trigger	$V_{GD}$	$T_J = 125\text{ }^\circ\text{C}$ , $V_{DRM} = \text{Rated value}$	0.25	
Maximum DC gate current not to trigger	$I_{GD}$		2.0	mA

SWITCHING				
PARAMETER	SYMBOL	TEST CONDITIONS	VALUES	UNITS
Typical turn-on time	$t_{gt}$	$T_J = 25\text{ }^\circ\text{C}$	0.9	$\mu s$
Typical reverse recovery time	$t_{rr}$	$T_J = 125\text{ }^\circ\text{C}$	4	
Typical turn-off time	$t_q$		110	



THERMAL AND MECHANICAL SPECIFICATIONS				
PARAMETER	SYMBOL	TEST CONDITIONS	VALUES	UNITS
Maximum junction and storage temperature range	$T_J, T_{Stg}$		- 40 to 125	°C
Maximum thermal resistance, junction to case	$R_{thJC}$	DC operation	0.8	°C/W
Maximum thermal resistance, junction to ambient	$R_{thJA}$		40	
Maximum thermal resistance, case to heatsink	$R_{thCS}$	Mounting surface, smooth and greased	0.2	
Approximate weight			6	g
			0.21	oz.
Mounting torque	minimum		6 (5)	kgf · cm (lbf · in)
	maximum			
Marking device		Case style TO-247AC (JEDEC)	30TPS08	
			30TPS12	

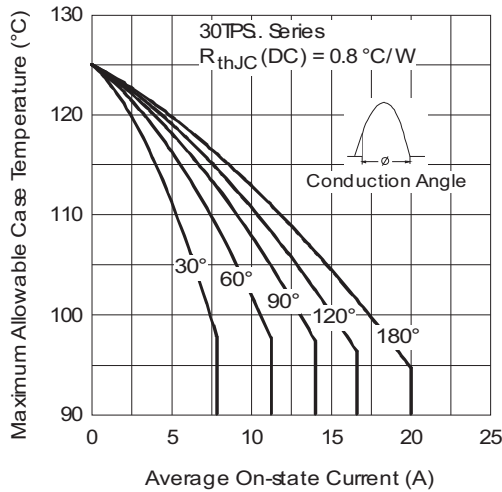

Fig. 1 - Current Rating Characteristics

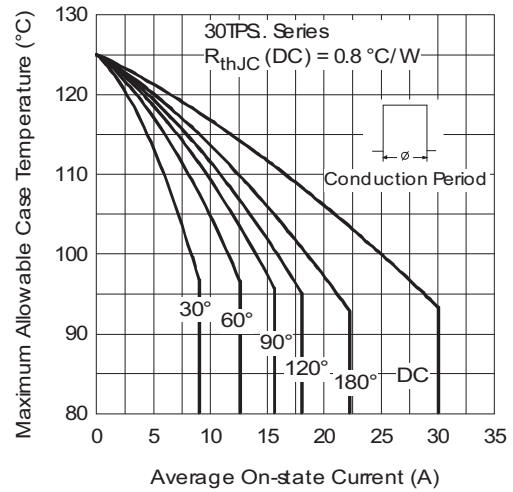

Fig. 2 - Current Rating Characteristics

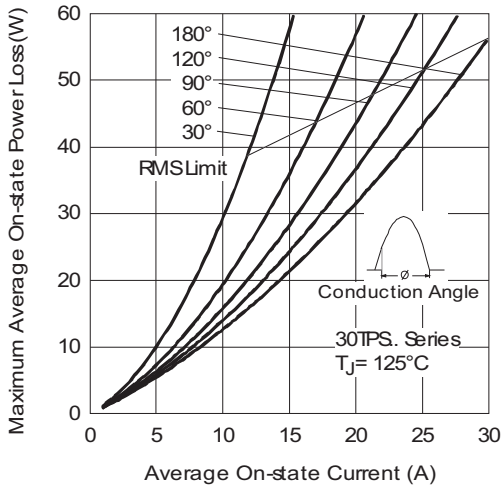

Fig. 3 - On-State Power Loss Characteristics

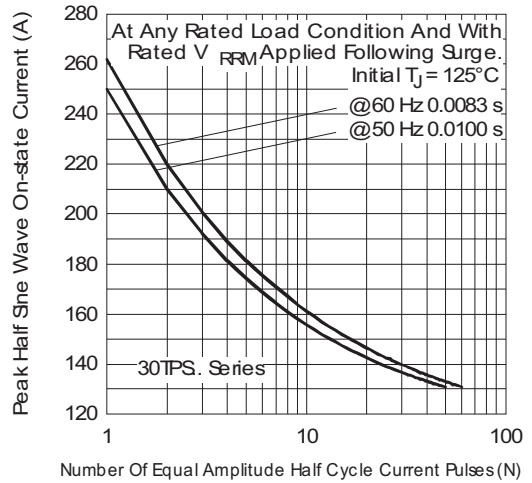

Fig. 5 - Maximum Non-Repetitive Surge Current

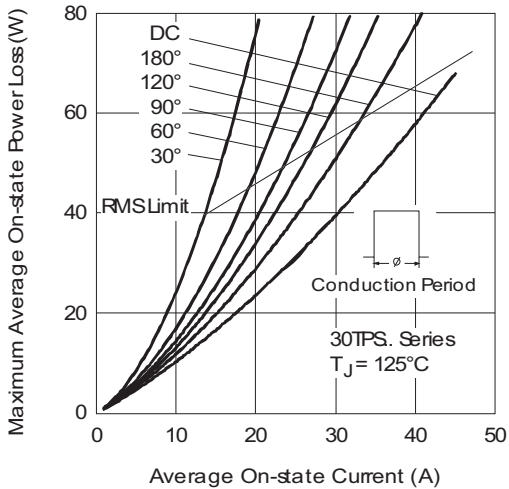

Fig. 4 - On-State Power Loss Characteristics

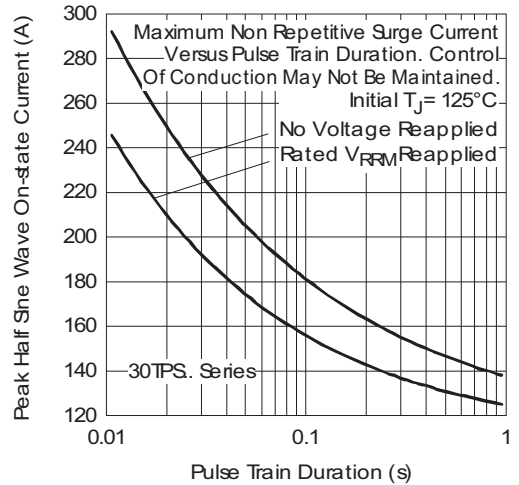

Fig. 6 - Maximum Non-Repetitive Surge Current

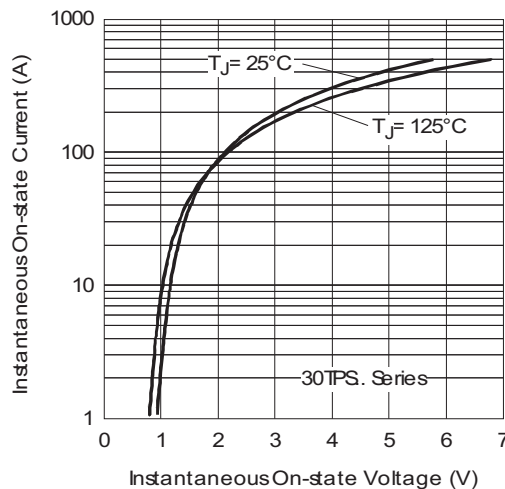

Fig. 7 - On-State Voltage Drop Characteristics

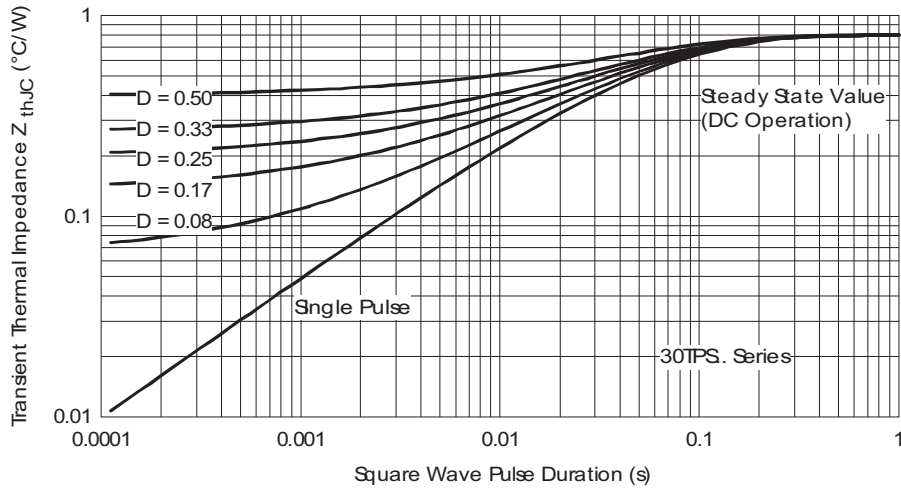

Fig. 8 - Thermal Impedance  $Z_{thJC}$  Characteristics

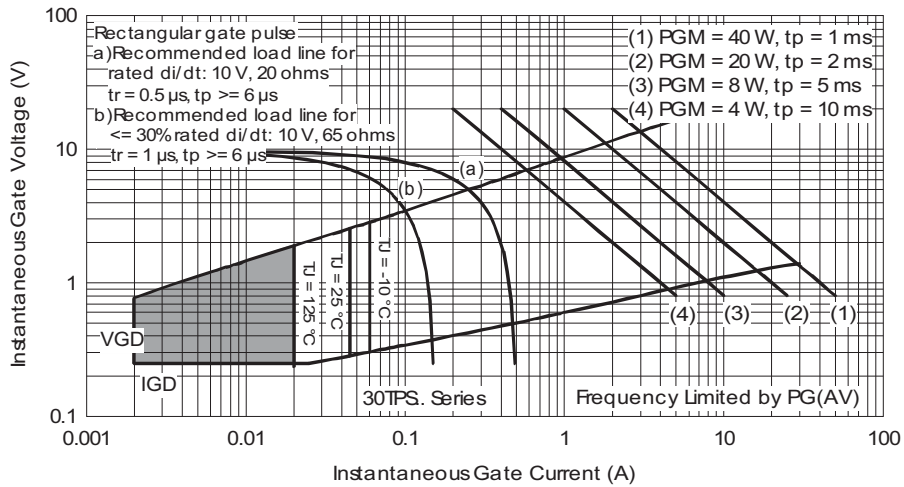
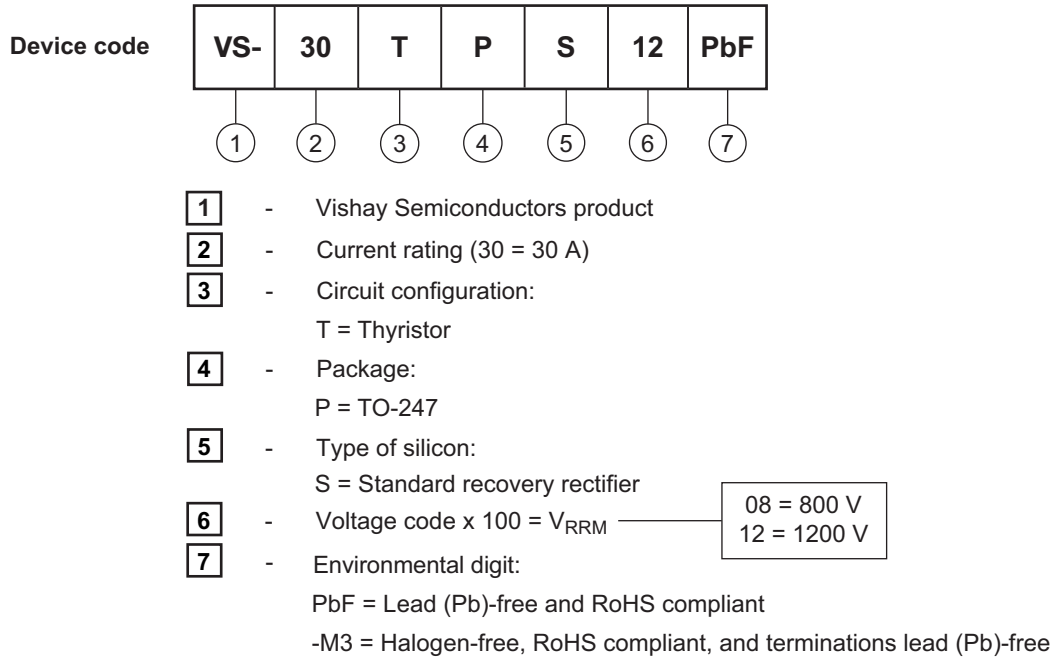

Fig. 9 - Gate Characteristics



## ORDERING INFORMATION TABLE



ORDERING INFORMATION (Example)			
PREFERRED P/N	QUANTITY PER T/R	MINIMUM ORDER QUANTITY	PACKAGING DESCRIPTION
VS-30TPS08PbF	25	500	Antistatic plastic tubes
VS-30TPS08-M3	25	500	Antistatic plastic tubes
VS-30TPS12PbF	25	500	Antistatic plastic tubes
VS-30TPS12-M3	25	500	Antistatic plastic tubes

LINKS TO RELATED DOCUMENTS	
Dimensions	<a href="http://www.vishay.com/doc?95223">www.vishay.com/doc?95223</a>
Part marking information	TO-247AC PbF <a href="http://www.vishay.com/doc?95226">www.vishay.com/doc?95226</a>
	TO-247AC -M3 <a href="http://www.vishay.com/doc?95007">www.vishay.com/doc?95007</a>



### DIMENSIONS in millimeters and inches



#### Lead assignments

- Diodes**  
 1. - Anode/open  
 2. - Cathode  
 3. - Anode

SYMBOL	MILLIMETERS		INCHES		NOTES
	MIN.	MAX.	MIN.	MAX.	
A	4.65	5.31	0.183	0.209	
A1	2.21	2.59	0.087	0.102	
A2	1.50	2.49	0.059	0.098	
b	0.99	1.40	0.039	0.055	
b1	0.99	1.35	0.039	0.053	
b2	1.65	2.39	0.065	0.094	
b3	1.65	2.37	0.065	0.094	
b4	2.59	3.43	0.102	0.135	
b5	2.59	3.38	0.102	0.133	
c	0.38	0.86	0.015	0.034	
c1	0.38	0.76	0.015	0.030	
D	19.71	20.70	0.776	0.815	3
D1	13.08	-	0.515	-	4
D2	0.51	1.30	0.020	0.051	
E	15.29	15.87	0.602	0.625	3
E1	13.72	-	0.540	-	
e	5.46 BSC		0.215 BSC		
FK	2.54		0.010		
L	14.20	16.10	0.559	0.634	
L1	3.71	4.29	0.146	0.169	
N	7.62 BSC		0.3		
$\Phi P$	3.56	3.66	0.14	0.144	
$\Phi P1$	-	6.98	-	0.275	
Q	5.31	5.69	0.209	0.224	
R	4.52	5.49	1.78	0.216	
S	5.51 BSC		0.217 BSC		

#### Notes

- (1) Dimensioning and tolerancing per ASME Y14.5M-1994
- (2) Contour of slot optional
- (3) Dimension D and E do not include mold flash. Mold flash shall not exceed 0.127 mm (0.005") per side. These dimensions are measured at the outermost extremes of the plastic body
- (4) Thermal pad contour optional with dimensions D1 and E1
- (5) Lead finish uncontrolled in L1
- (6)  $\Phi P$  to have a maximum draft angle of 1.5 to the top of the part with a maximum hole diameter of 3.91 mm (0.154")
- (7) Outline conforms to JEDEC outline TO-247 with exception of dimension c

## TO-247

**DIMENSIONS** in millimeters and inches

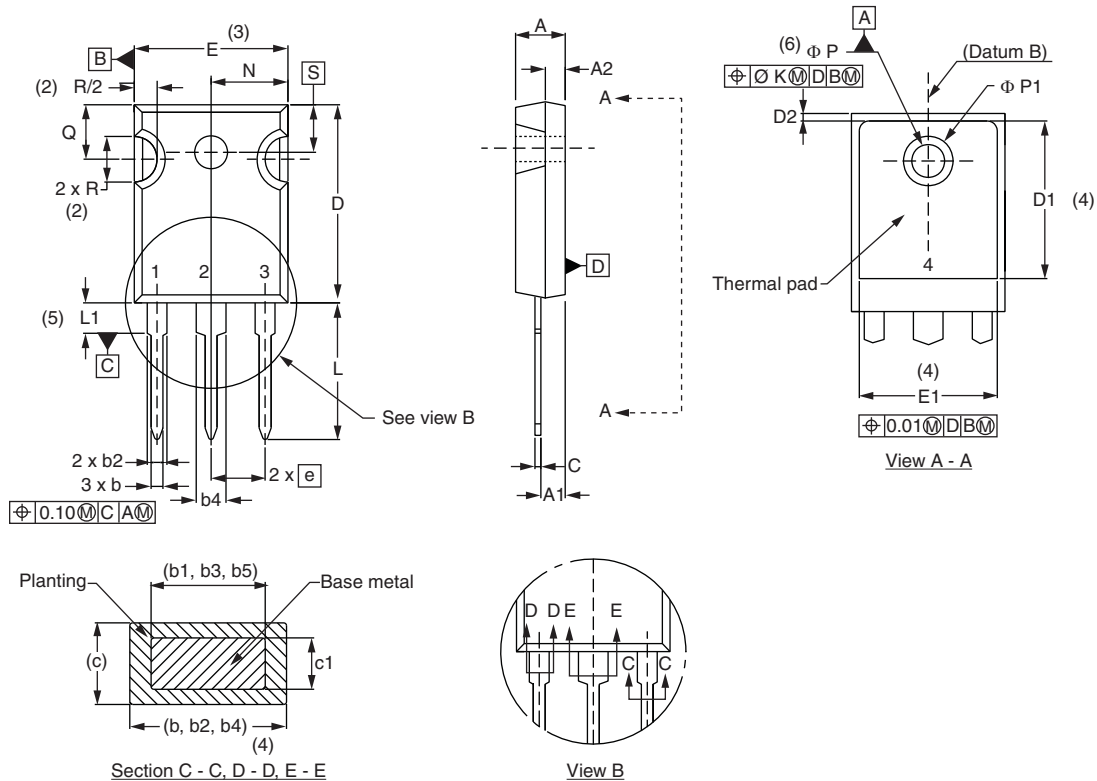

SYMBOL	MILLIMETERS		INCHES		NOTES
	MIN.	MAX.	MIN.	MAX.	
A	4.65	5.31	0.183	0.209	
A1	2.21	2.59	0.087	0.102	
A2	1.17	1.37	0.046	0.054	
b	0.99	1.40	0.039	0.055	
b1	0.99	1.35	0.039	0.053	
b2	1.65	2.39	0.065	0.094	
b3	1.65	2.33	0.065	0.092	
b4	2.59	3.43	0.102	0.135	
b5	2.59	3.38	0.102	0.133	
c	0.38	0.89	0.015	0.035	
c1	0.38	0.84	0.015	0.033	
D	19.71	20.70	0.776	0.815	3
D1	13.08	-	0.515	-	4
D2	0.51	1.35	0.020	0.053	
E	15.29	15.87	0.602	0.625	3
E1	13.46	-	0.53	-	
e	5.46 BSC		0.215 BSC		
Ø K	0.254		0.010		
L	14.20	16.10	0.559	0.634	
L1	3.71	4.29	0.146	0.169	
N	7.62 BSC		0.3		
Ø P	3.56	3.66	0.14	0.144	
Ø P1	-	7.39	-	0.291	
Q	5.31	5.69	0.209	0.224	
R	4.52	5.49	0.178	0.216	
S	5.51 BSC		0.217 BSC		

**Notes**

- (1) Dimensioning and tolerancing per ASME Y14.5M-1994
- (2) Contour of slot optional
- (3) Dimension D and E do not include mold flash. Mold flash shall not exceed 0.127 mm (0.005") per side. These dimensions are measured at the outermost extremes of the plastic body
- (4) Thermal pad contour optional with dimensions D1 and E1
- (5) Lead finish uncontrolled in L1
- (6) Ø P to have a maximum draft angle of 1.5 to the top of the part with a maximum hole diameter of 3.91 mm (0.154")
- (7) Outline conforms to JEDEC® outline TO-247 with exception of dimension c and Q





## Disclaimer

ALL PRODUCT, PRODUCT SPECIFICATIONS AND DATA ARE SUBJECT TO CHANGE WITHOUT NOTICE TO IMPROVE RELIABILITY, FUNCTION OR DESIGN OR OTHERWISE.

Vishay Intertechnology, Inc., its affiliates, agents, and employees, and all persons acting on its or their behalf (collectively, "Vishay"), disclaim any and all liability for any errors, inaccuracies or incompleteness contained in any datasheet or in any other disclosure relating to any product.

Vishay makes no warranty, representation or guarantee regarding the suitability of the products for any particular purpose or the continuing production of any product. To the maximum extent permitted by applicable law, Vishay disclaims (i) any and all liability arising out of the application or use of any product, (ii) any and all liability, including without limitation special, consequential or incidental damages, and (iii) any and all implied warranties, including warranties of fitness for particular purpose, non-infringement and merchantability.

Statements regarding the suitability of products for certain types of applications are based on Vishay's knowledge of typical requirements that are often placed on Vishay products in generic applications. Such statements are not binding statements about the suitability of products for a particular application. It is the customer's responsibility to validate that a particular product with the properties described in the product specification is suitable for use in a particular application. Parameters provided in datasheets and/or specifications may vary in different applications and performance may vary over time. All operating parameters, including typical parameters, must be validated for each customer application by the customer's technical experts. Product specifications do not expand or otherwise modify Vishay's terms and conditions of purchase, including but not limited to the warranty expressed therein.

Except as expressly indicated in writing, Vishay products are not designed for use in medical, life-saving, or life-sustaining applications or for any other application in which the failure of the Vishay product could result in personal injury or death. Customers using or selling Vishay products not expressly indicated for use in such applications do so at their own risk. Please contact authorized Vishay personnel to obtain written terms and conditions regarding products designed for such applications.

No license, express or implied, by estoppel or otherwise, to any intellectual property rights is granted by this document or by any conduct of Vishay. Product names and markings noted herein may be trademarks of their respective owners.

## Material Category Policy

**Vishay Intertechnology, Inc. hereby certifies that all its products that are identified as RoHS-Compliant fulfill the definitions and restrictions defined under Directive 2011/65/EU of The European Parliament and of the Council of June 8, 2011 on the restriction of the use of certain hazardous substances in electrical and electronic equipment (EEE) - recast, unless otherwise specified as non-compliant.**

**Please note that some Vishay documentation may still make reference to RoHS Directive 2002/95/EC. We confirm that all the products identified as being compliant to Directive 2002/95/EC conform to Directive 2011/65/EU.**

**Vishay Intertechnology, Inc. hereby certifies that all its products that are identified as Halogen-Free follow Halogen-Free requirements as per JEDEC JS709A standards. Please note that some Vishay documentation may still make reference to the IEC 61249-2-21 definition. We confirm that all the products identified as being compliant to IEC 61249-2-21 conform to JEDEC JS709A standards.**

Компания «Life Electronics» занимается поставками электронных компонентов импортного и отечественного производства от производителей и со складов крупных дистрибьюторов Европы, Америки и Азии.

С конца 2013 года компания активно расширяет линейку поставок компонентов по направлению коаксиальный кабель, кварцевые генераторы и конденсаторы (керамические, пленочные, электролитические), за счёт заключения дистрибьюторских договоров

Мы предлагаем:

- Конкурентоспособные цены и скидки постоянным клиентам.
- Специальные условия для постоянных клиентов.
- Подбор аналогов.
- Поставку компонентов в любых объемах, удовлетворяющих вашим потребностям.
- Приемлемые сроки поставки, возможна ускоренная поставка.
- Доставку товара в любую точку России и стран СНГ.
- Комплексную поставку.
- Работу по проектам и поставку образцов.
- Формирование склада под заказчика.
- Сертификаты соответствия на поставляемую продукцию (по желанию клиента).
- Тестирование поставляемой продукции.
- Поставку компонентов, требующих военную и космическую приемку.
- Входной контроль качества.
- Наличие сертификата ISO.

В составе нашей компании организован Конструкторский отдел, призванный помогать разработчикам, и инженерам.

Конструкторский отдел помогает осуществить:

- Регистрацию проекта у производителя компонентов.
- Техническую поддержку проекта.
- Защиту от снятия компонента с производства.
- Оценку стоимости проекта по компонентам.
- Изготовление тестовой платы монтаж и пусконаладочные работы.



Тел: +7 (812) 336 43 04 (многоканальный)  
Email: [org@lifeelectronics.ru](mailto:org@lifeelectronics.ru)