

RoHS Compliant



1:1 Transmission Line Transformer, with center tap
5-1000MHz

MABACT0040
V1P

Features

- Surface Mount
- 1:1 Impedance
- Centre tap on secondary
- 260°C Reflow Compatible
- RoHS* Compliant
- Available on Tape and Reel. Reel quantity 2000

Description

M/A-COM's MABACT0040 is a 1:1 RF Transmission Line transformer in a low cost, surface mount package. Excellent Return Loss. Ideally suited for high volume CATV/Broadband applications.

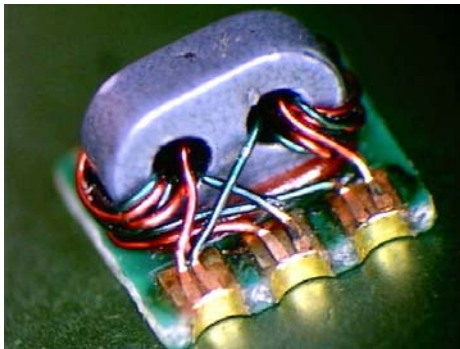

Schematic

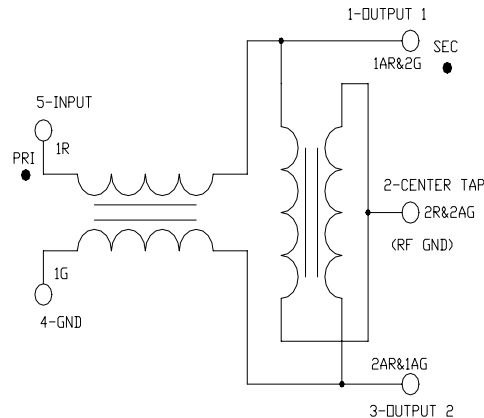

Case Style: SM-164

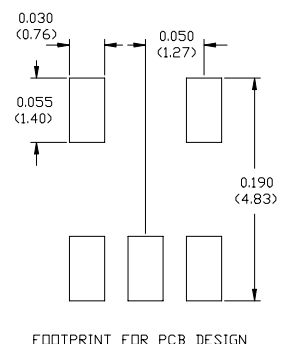
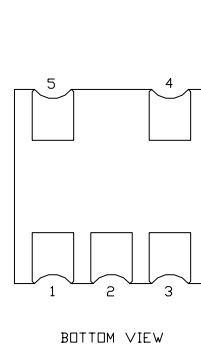
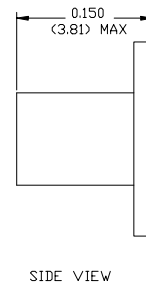
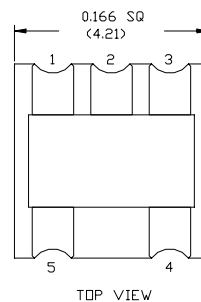

Pin Configuration

Pin No.	Function
1	Secondary Dot (Output 1)
2	Secondary centre tap (Ground)
3	Secondary (Output 2)
4	Primary (Ground)
5	Primary Dot (Input)

Ordering Information

Part Number	Package
MABACT0040TR	2000 piece reel

Dimensions in inches [mm] Tolerance: .xx ± .02, .xxx ± .010

Note: Reference Application Note **M513** for reel size information.

* Restrictions on Hazardous Substances, European Union Directive 2002/95/EC.

ADVANCED: Data Sheets contain information regarding a product M/A-COM Technology Solutions is considering for development. Performance is based on target specifications, simulated results, and/or prototype measurements. Commitment to develop is not guaranteed.

PRELIMINARY: Data Sheets contain information regarding a product M/A-COM Technology Solutions has under development. Performance is based on engineering tests. Specifications are typical. Mechanical outline has been fixed. Engineering samples and/or test data may be available. Commitment to produce in volume is not guaranteed.

• North America Tel: 800.366.2266 • Europe Tel: +353.21.244.6400
• India Tel: +91.80.4155721 • China Tel: +86.21.2407.1588

Visit www.macomtech.com for additional data sheets and product information.

M/A-COM Technology Solutions Inc. and its affiliates reserve the right to make changes to the product(s) or information contained herein without notice.

RoHS Compliant



1:1 Transmission Line Transformer, with center tap
5-1000MHz

MABACT0040
V1P

Electrical Specifications: $T_A = 25^\circ\text{C}$, $Z_0 = 75\Omega$

Parameter	Test Conditions	Frequency	Units	Min	Typ	Max
Insertion Loss	-	5 - 1000 MHz	dB	-	1.1	1.6
Amplitude Unbalance (Nominal 0dB)	-	5 - 1000 MHz	dB	-	± 0.1	± 0.5
Phase Unbalance (Nominal 180°)	-	5 - 1000 MHz	°	-	5	± 10
Input Return Loss	-	5 - 1000 MHz	dB	16	24	-

Absolute Maximum Ratings ^{1,2}

Parameter	Absolute Maximum
Max Input Power	250mW
DC current	240mA
Operating Temperature	-40°C to +85°C
Storage Temperature	-55°C to +100°C

- Exceeding any one or combination of these limits may cause permanent damage to this device.
- M/A-COM does not recommend sustained operation near these survivability limits.

Recommended PCB Configuration

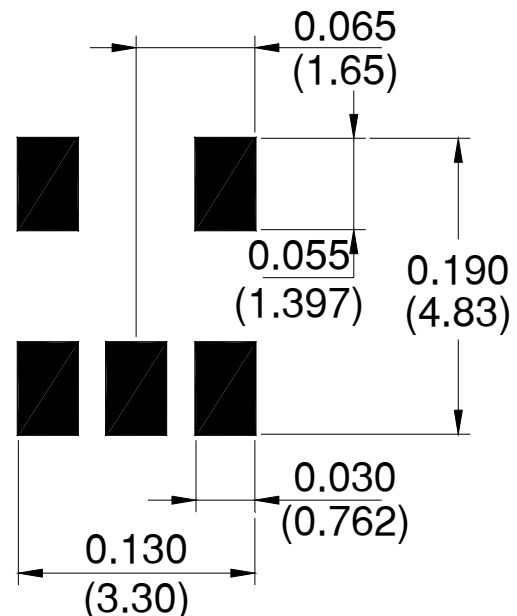

2

ADVANCED: Data Sheets contain information regarding a product M/A-COM Technology Solutions is considering for development. Performance is based on target specifications, simulated results, and/or prototype measurements. Commitment to develop is not guaranteed.

PRELIMINARY: Data Sheets contain information regarding a product M/A-COM Technology Solutions has under development. Performance is based on engineering tests. Specifications are typical. Mechanical outline has been fixed. Engineering samples and/or test data may be available. Commitment to produce in volume is not guaranteed.

• North America Tel: 800.366.2266 • Europe Tel: +353.21.244.6400
• India Tel: +91.80.4155721 • China Tel: +86.21.2407.1588

Visit www.macomtech.com for additional data sheets and product information.

M/A-COM Technology Solutions Inc. and its affiliates reserve the right to make changes to the product(s) or information contained herein without notice.

RoHS Compliant



1:1 Transmission Line Transformer, with center tap
5-1000MHz

MABACT0040
V1P

Typical Performance Curves: $T_A = 25^\circ\text{C}$, $Z_0 = 75\Omega$

Insertion Loss 1: Pin 5 to 1

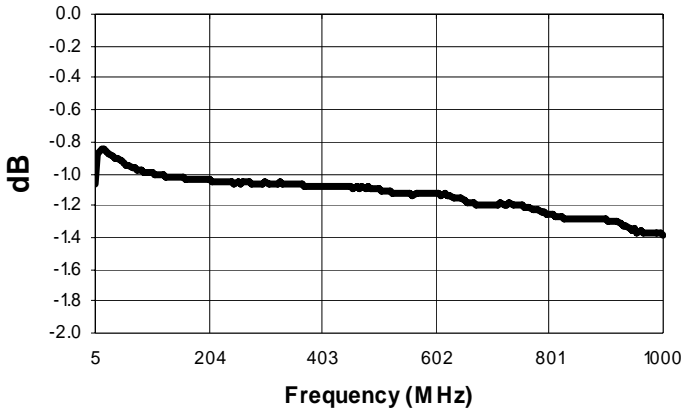

Insertion Loss 2: Pin 5 to 3

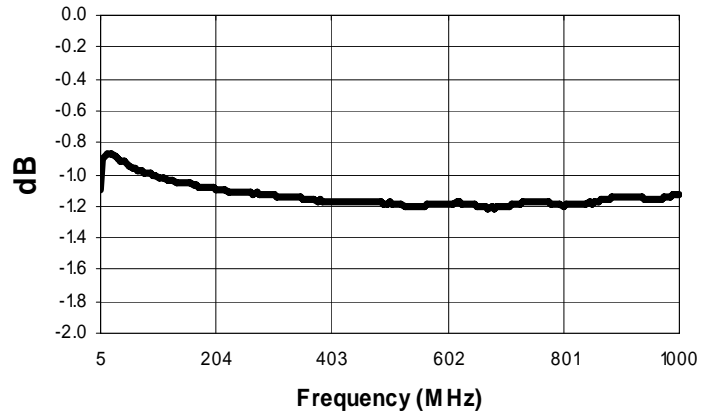

Amplitude Unbalance

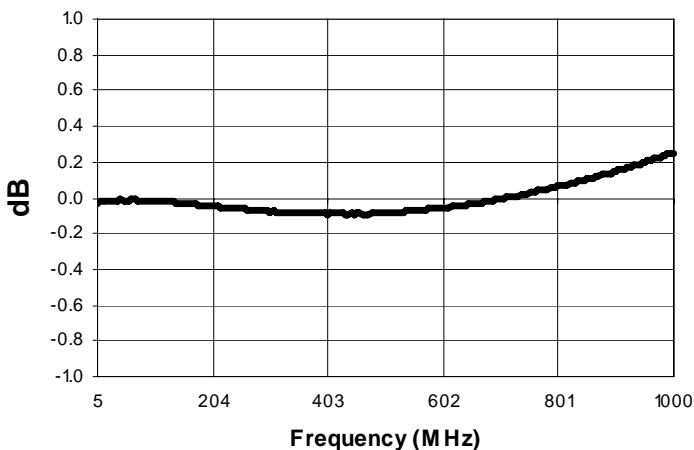

Phase Balance

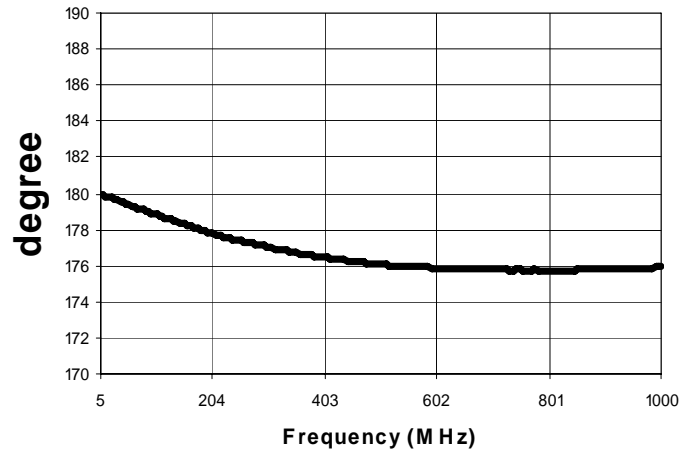

Input Return Loss

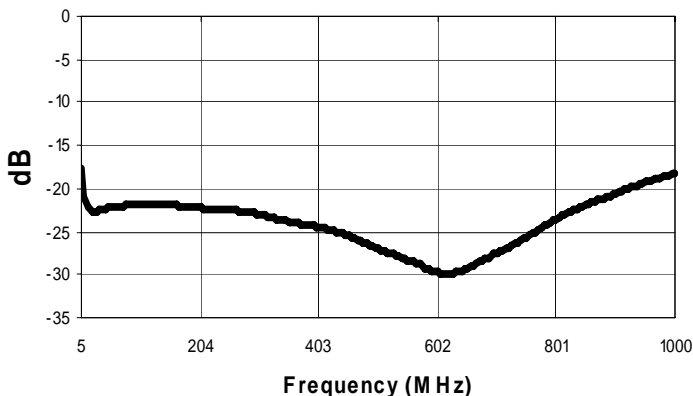

Компания «Life Electronics» занимается поставками электронных компонентов импортного и отечественного производства от производителей и со складов крупных дистрибьюторов Европы, Америки и Азии.

С конца 2013 года компания активно расширяет линейку поставок компонентов по направлению коаксиальный кабель, кварцевые генераторы и конденсаторы (керамические, пленочные, электролитические), за счёт заключения дистрибьюторских договоров

Мы предлагаем:

- Конкурентоспособные цены и скидки постоянным клиентам.
- Специальные условия для постоянных клиентов.
- Подбор аналогов.
- Поставку компонентов в любых объемах, удовлетворяющих вашим потребностям.
- Приемлемые сроки поставки, возможна ускоренная поставка.
- Доставку товара в любую точку России и стран СНГ.
- Комплексную поставку.
- Работу по проектам и поставку образцов.
- Формирование склада под заказчика.
- Сертификаты соответствия на поставляемую продукцию (по желанию клиента).
- Тестирование поставляемой продукции.
- Поставку компонентов, требующих военную и космическую приемку.
- Входной контроль качества.
- Наличие сертификата ISO.

В составе нашей компании организован Конструкторский отдел, призванный помогать разработчикам, и инженерам.

Конструкторский отдел помогает осуществить:

- Регистрацию проекта у производителя компонентов.
- Техническую поддержку проекта.
- Защиту от снятия компонента с производства.
- Оценку стоимости проекта по компонентам.
- Изготовление тестовой платы монтаж и пусконаладочные работы.



Тел: +7 (812) 336 43 04 (многоканальный)

Email: org@lifeelectronics.ru