

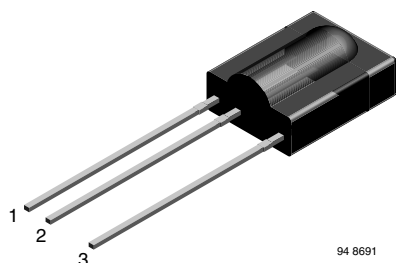

IR Sensor Module for Remote Control Systems



94 8691

MECHANICAL DATA

Pinning:

1 = GND, 2 = Carrier OUT, 3 = V_S

FEATURES

- Photo detector and preamplifier in one package
- AC coupled response from 30 kHz to 50 kHz, all data formats
- If the IR signal strength is less than 1 W/m^2 (distance more than 0.3 m with a typical IR remote control), the frequency range is up to 55 kHz
- If the IR signal strength is less than 8 mW/m^2 (distance more than 3.5 m with a typical IR remote control), the frequency range is up to 60 kHz
- Improved shielding against electrical field disturbance
- AGC to suppress ambient noise
- High sensitivity, long receiving range
- Supply voltage: 2.7 V to 5.5 V
- Carrier out signal for IR repeater applications
- Material categorization: For definitions of compliance please see www.vishay.com/doc?99912



RoHS
COMPLIANT
GREEN
(5-2008)

DESCRIPTION

The TSOP98138 is a miniaturized sensor for receiving the modulated signal of infrared remote control systems. A PIN diode and preamplifier are assembled on a lead frame, the epoxy package is designed as an IR filter. The modulated output signal, carrier out, can be used for repeater applications and code learning applications.

This component has not been qualified according to automotive specifications.

PARTS TABLE	
CARRIER FREQUENCY	CODE LEARNING APPLICATIONS
30 kHz to 50 kHz	TSOP98138

BLOCK DIAGRAM

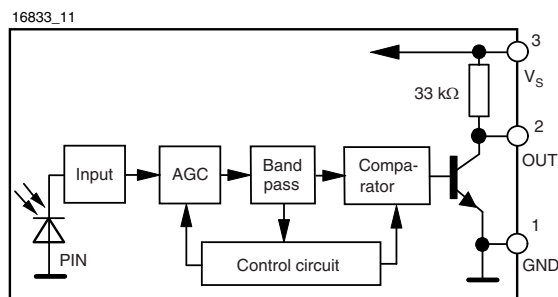

APPLICATION CIRCUIT

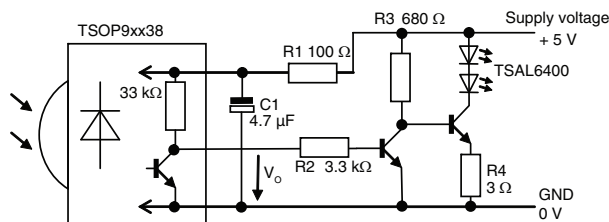

Recommended circuit for best sensitivity of the TSOP9xx38 in repeater applications. It limits the output voltage swing V_o to about 1 V in order to avoid internal coupling. The high level output voltage V_o should never be pulled to a voltage lower than 0.85 V by the external circuit under any ambient condition.



ABSOLUTE MAXIMUM RATINGS				
PARAMETER	TEST CONDITION	SYMBOL	VALUE	UNIT
Supply voltage (pin 3)		V_S	- 0.3 to + 6	V
Supply current (pin 3)		I_S	5	mA
Output voltage (pin 2)		V_O	- 0.3 to 5.5	V
Voltage at output to supply		$V_S - V_O$	- 0.3 to ($V_S + 0.3$)	V
Output current (pin 2)		I_O	5	mA
Junction temperature		T_j	100	°C
Storage temperature range		T_{stg}	- 25 to + 85	°C
Operating temperature range		T_{amb}	- 25 to + 85	°C
Power consumption	$T_{amb} \leq 85 \text{ }^\circ\text{C}$	P_{tot}	10	mW
Soldering temperature	$t \leq 10 \text{ s, } 1 \text{ mm from case}$	T_{sd}	260	°C

Note

- Stresses beyond those listed under “Absolute Maximum Ratings” may cause permanent damage to the device. This is a stress rating only and functional operation of the device at these or any other conditions beyond those indicated in the operational sections of this specification is not implied. Exposure to absolute maximum rating conditions for extended periods may affect the device reliability.

ELECTRICAL AND OPTICAL CHARACTERISTICS ($T_{amb} = 25 \text{ }^\circ\text{C}$, unless otherwise specified)						
PARAMETER	TEST CONDITION	SYMBOL	MIN.	TYP.	MAX.	UNIT
Supply current (pin 3)	$E_v = 0, V_S = 5 \text{ V}$	I_{SD}	0.65	0.85	1.05	mA
	$E_v = 40 \text{ klx, sunlight}$	I_{SH}		0.95		mA
Supply voltage		V_S	2.7		5.5	V
Transmission distance	$E_v = 0$, test signal see fig. 1, IR diode TSAL6200, $I_F = 400 \text{ mA}$	d		30		m
Output voltage low (pin 2)	$I_{OSL} = 0.5 \text{ mA, } E_e = 0.7 \text{ mW/m}^2$, test signal see fig. 1	V_{OSL}			100	mV
Minimum irradiance	Less than 5 missing or 5 additional sub carrier pulses related to one burst	$E_e \text{ min.}$		0.5	1	mW/m ²
Maximum irradiance	Less than 5 missing or 5 additional sub carrier pulses related to one burst	$E_e \text{ max.}$	30			W/m ²
Directivity	Angle of half transmission distance	$\phi_{1/2}$		± 55		deg

TYPICAL CHARACTERISTICS ($T_{amb} = 25 \text{ }^\circ\text{C}$, unless otherwise specified)

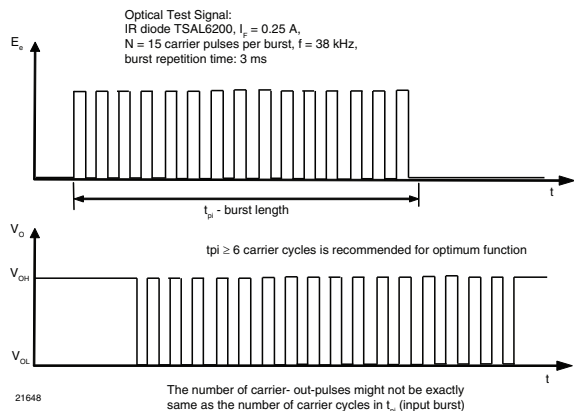

Fig. 1 - Output Function

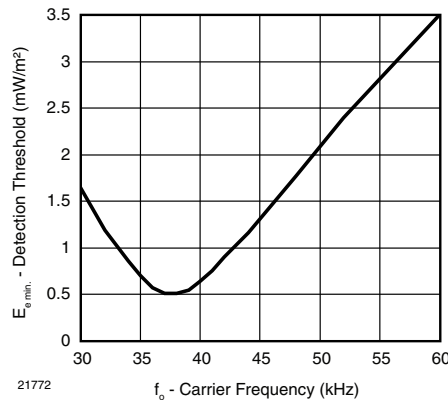

Fig. 2 - Frequency Dependence of Sensitivity

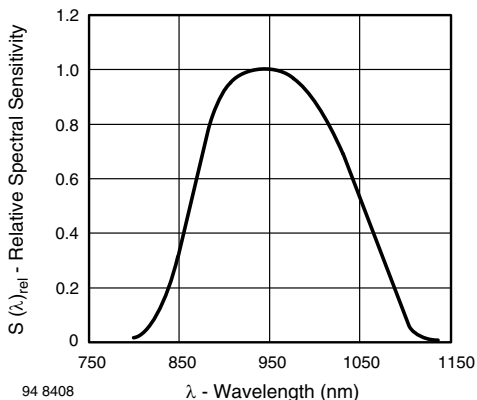

Fig. 3 - Relative Spectral Sensitivity vs. Wavelength

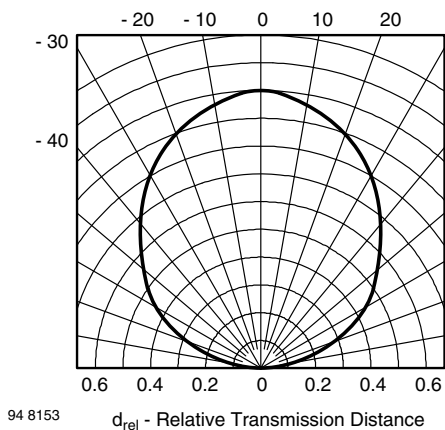

Fig. 4 - Horizontal Directivity ϕ_x

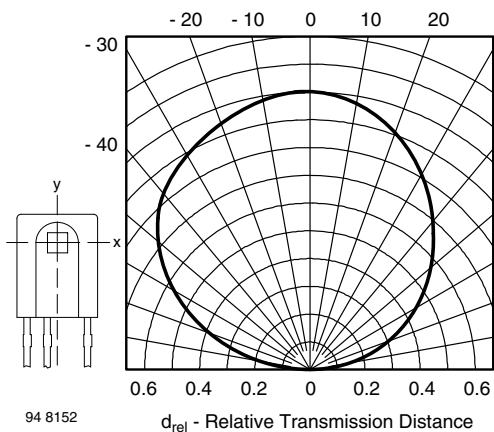
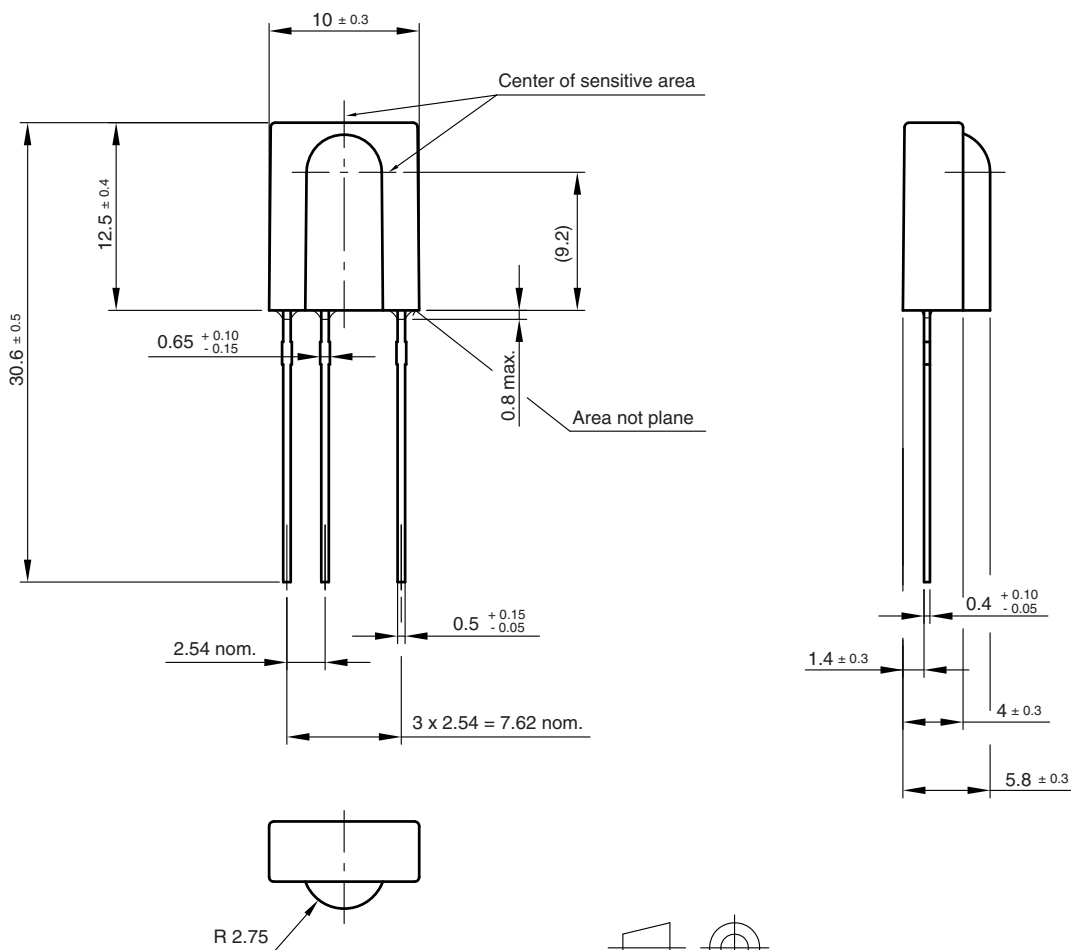

Fig. 5 - Vertical Directivity ϕ_y



PACKAGE DIMENSIONS in millimeters



technical drawings according to DIN specifications

Drawing-No.: 6.550-5095.01-4
Issue: xx; 20.05.09
96 12116-1



Disclaimer

ALL PRODUCT, PRODUCT SPECIFICATIONS AND DATA ARE SUBJECT TO CHANGE WITHOUT NOTICE TO IMPROVE RELIABILITY, FUNCTION OR DESIGN OR OTHERWISE.

Vishay Intertechnology, Inc., its affiliates, agents, and employees, and all persons acting on its or their behalf (collectively, "Vishay"), disclaim any and all liability for any errors, inaccuracies or incompleteness contained in any datasheet or in any other disclosure relating to any product.

Vishay makes no warranty, representation or guarantee regarding the suitability of the products for any particular purpose or the continuing production of any product. To the maximum extent permitted by applicable law, Vishay disclaims (i) any and all liability arising out of the application or use of any product, (ii) any and all liability, including without limitation special, consequential or incidental damages, and (iii) any and all implied warranties, including warranties of fitness for particular purpose, non-infringement and merchantability.

Statements regarding the suitability of products for certain types of applications are based on Vishay's knowledge of typical requirements that are often placed on Vishay products in generic applications. Such statements are not binding statements about the suitability of products for a particular application. It is the customer's responsibility to validate that a particular product with the properties described in the product specification is suitable for use in a particular application. Parameters provided in datasheets and / or specifications may vary in different applications and performance may vary over time. All operating parameters, including typical parameters, must be validated for each customer application by the customer's technical experts. Product specifications do not expand or otherwise modify Vishay's terms and conditions of purchase, including but not limited to the warranty expressed therein.

Except as expressly indicated in writing, Vishay products are not designed for use in medical, life-saving, or life-sustaining applications or for any other application in which the failure of the Vishay product could result in personal injury or death. Customers using or selling Vishay products not expressly indicated for use in such applications do so at their own risk. Please contact authorized Vishay personnel to obtain written terms and conditions regarding products designed for such applications.

No license, express or implied, by estoppel or otherwise, to any intellectual property rights is granted by this document or by any conduct of Vishay. Product names and markings noted herein may be trademarks of their respective owners.

Компания «Life Electronics» занимается поставками электронных компонентов импортного и отечественного производства от производителей и со складов крупных дистрибьюторов Европы, Америки и Азии.

С конца 2013 года компания активно расширяет линейку поставок компонентов по направлению коаксиальный кабель, кварцевые генераторы и конденсаторы (керамические, пленочные, электролитические), за счёт заключения дистрибьюторских договоров

Мы предлагаем:

- Конкуренспособные цены и скидки постоянным клиентам.
- Специальные условия для постоянных клиентов.
- Подбор аналогов.
- Поставку компонентов в любых объемах, удовлетворяющих вашим потребностям.
- Приемлемые сроки поставки, возможна ускоренная поставка.
- Доставку товара в любую точку России и стран СНГ.
- Комплексную поставку.
- Работу по проектам и поставку образцов.
- Формирование склада под заказчика.
- Сертификаты соответствия на поставляемую продукцию (по желанию клиента).
- Тестирование поставляемой продукции.
- Поставку компонентов, требующих военную и космическую приемку.
- Входной контроль качества.
- Наличие сертификата ISO.

В составе нашей компании организован Конструкторский отдел, призванный помогать разработчикам, и инженерам.

Конструкторский отдел помогает осуществить:

- Регистрацию проекта у производителя компонентов.
- Техническую поддержку проекта.
- Защиту от снятия компонента с производства.
- Оценку стоимости проекта по компонентам.
- Изготовление тестовой платы монтаж и пусконаладочные работы.



Тел: +7 (812) 336 43 04 (многоканальный)
Email: org@lifeelectronics.ru