

TSM180P03CS

30V P-Channel Power MOSFET



Pin Definition:

- | | |
|-----------|----------|
| 1. Source | 8. Drain |
| 2. Source | 7. Drain |
| 3. Source | 6. Drain |
| 4. Gate | 5. Drain |

Key Parameter Performance

Parameter	Value	Unit
V_{DS}	-30	V
$R_{DS(on)}$ (max)	$V_{GS} = -10V$	18
	$V_{GS} = -4.5V$	30
Q_g	14.6	nC

Ordering Information

Part No.	Package	Packing
TSM180P03CS RLG	SOP-8	2.5kpcs / 13" Reel

Note: "G" denotes for Halogen- and Antimony-free as those which contain <900ppm bromine, <900ppm chlorine (<1500ppm total Br + Cl) and <1000ppm antimony compounds

Block Diagram

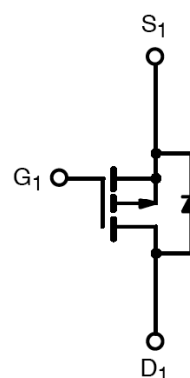

P-Channel MOSFET

Absolute Maximum Ratings ($T_C=25^{\circ}C$ unless otherwise noted)

Parameter	Symbol	Limit	Unit
Drain-Source Voltage	V_{DS}	-30	V
Gate-Source Voltage	V_{GS}	± 20	V
Continuous Drain Current	I_D	$T_C=25^{\circ}C$	-10
		$T_C=100^{\circ}C$	-6.3
Pulsed Drain Current (Note 1)	I_{DM}	-40	A
Power Dissipation @ $T_C = 25^{\circ}C$	P_D	2.5	W
Operating Junction Temperature	T_J	150	$^{\circ}C$
Storage Temperature Range	T_{STG}	-55 to +150	$^{\circ}C$

Thermal Performance

Parameter	Symbol	Limit	Unit
Thermal Resistance - Junction to Ambient	$R_{\theta JA}$	50	$^{\circ}C/W$

Electrical Specifications (T_J=25°C unless otherwise noted)

Parameter	Conditions	Symbol	Min	Typ	Max	Unit
Static						
Drain-Source Breakdown Voltage	V _{GS} = 0V, I _D = -250μA	BV _{DSS}	-30	--	--	V
Drain-Source On-State Resistance	V _{GS} = -10V, I _D = -8A	R _{DS(ON)}	--	14	18	mΩ
	V _{GS} = -4.5V, I _D = -6A		--	23	30	
Gate Threshold Voltage	V _{DS} = V _{GS} , I _D = -250μA	V _{GS(TH)}	-1.2	-1.6	-2.5	V
Zero Gate Voltage Drain Current	V _{DS} = -30V, V _{GS} = 0V	I _{DSS}	--	--	-1	μA
	V _{DS} = -24V, T _J = 125°C		--	--	-10	
Gate Body Leakage	V _{GS} = ±20V, V _{DS} = 0V	I _{GSS}	--	--	±100	nA
Forward Transconductance ^(Note 2)	V _{DS} = -10V, I _D = -8A	g _{fs}	--	10.5	--	S
Dynamic						
Total Gate Charge ^(Note 2,3)	V _{DS} = -15V, I _D = -8A, V _{GS} = -4.5V	Q _g	--	14.6	--	nC
Gate-Source Charge ^(Note 2,3)		Q _{gs}	--	4.1	--	
Gate-Drain Charge ^(Note 2,3)		Q _{gd}	--	6.3	--	
Input Capacitance	V _{DS} = -15V, V _{GS} = 0V, f = 1.0MHz	C _{iss}	--	1730	--	pF
Output Capacitance		C _{oss}	--	180	--	
Reverse Transfer Capacitance		C _{rss}	--	125	--	
Switching						
Turn-On Delay Time ^(Note 2,3)	V _{DD} = -15V, I _D = -1A, V _{GS} = -10V, R _{GEN} = 6Ω	t _{d(on)}	--	9	--	ns
Turn-On Rise Time ^(Note 2,3)		t _r	--	21.8	--	
Turn-Off Delay Time ^(Note 2,3)		t _{d(off)}	--	59.8	--	
Turn-Off Fall Time ^(Note 2,3)		t _f	--	14.4	--	
Source-Drain Diode Ratings and Characteristic						
Maximum Continuous Drain-Source Diode Forward Current	Integral reverse diode in the MOSFET	I _S	--	--	-10	A
Maximum Pulse Drain-Source Diode Forward Current		I _{SM}	--	--	-40	A
Diode-Source Forward Voltage	V _{GS} = 0V, I _S = -1A	V _{SD}	--	--	-1	V

Note:

1. Pulse width limited by safe operating area
2. Pulse test: pulse width ≤300μs, duty cycle ≤2%
3. Switching time is essentially independent of operating temperature.

Electrical Characteristics Curve

Continuous Drain Current vs. T_C

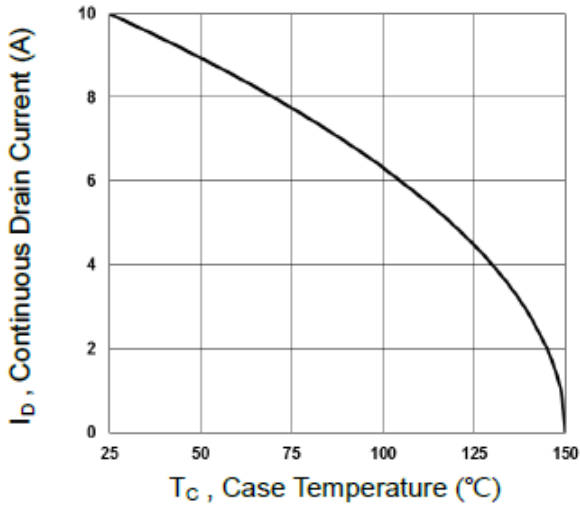

Gate Charge

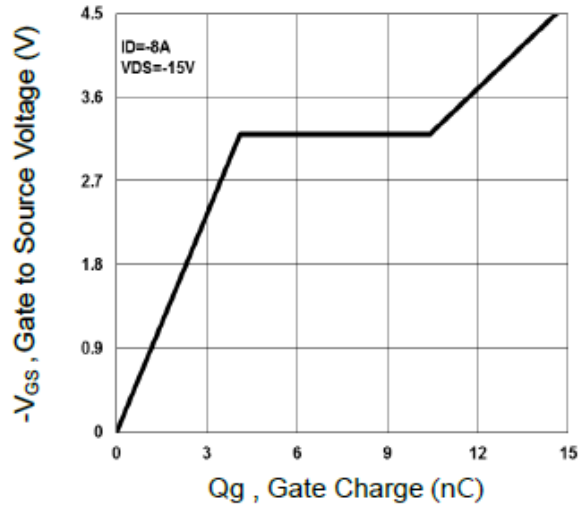

On-Resistance vs. Junction Temperature

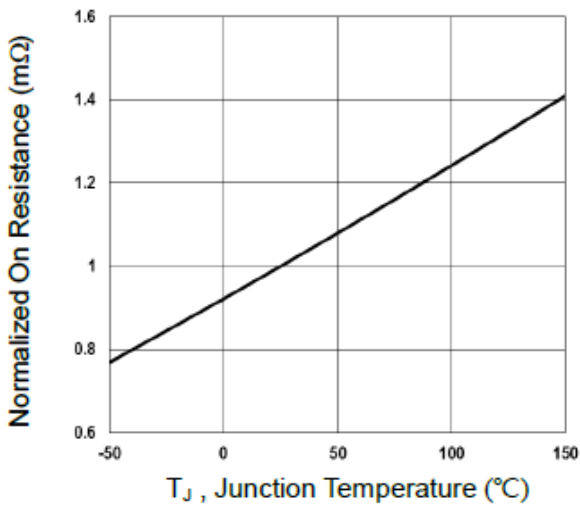

Threshold Voltage vs. Junction Temperature

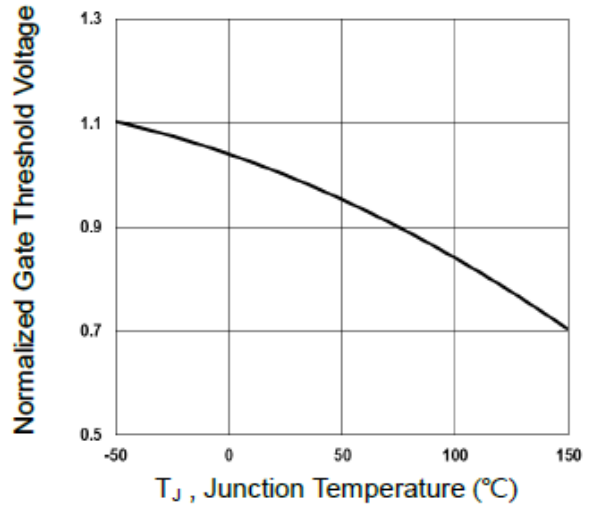

Maximum Safe Operating Area

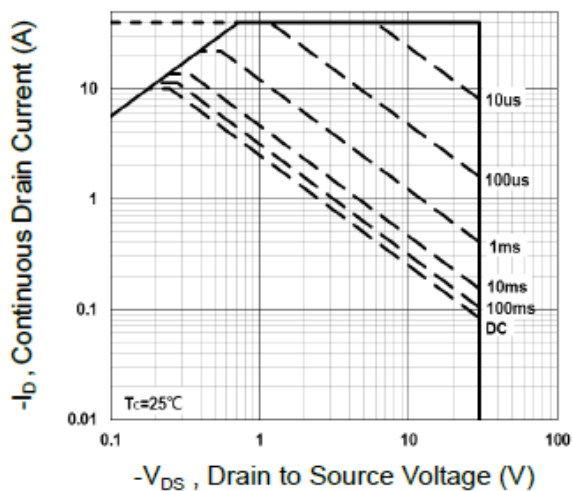

Normalized Thermal Transient Impedance Curve

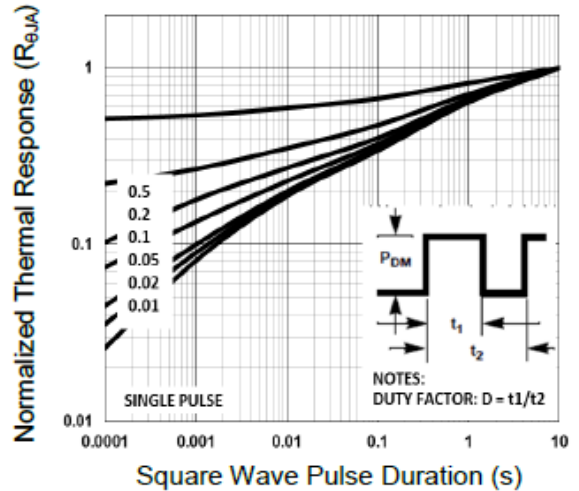



SOP-8 Mechanical Drawing

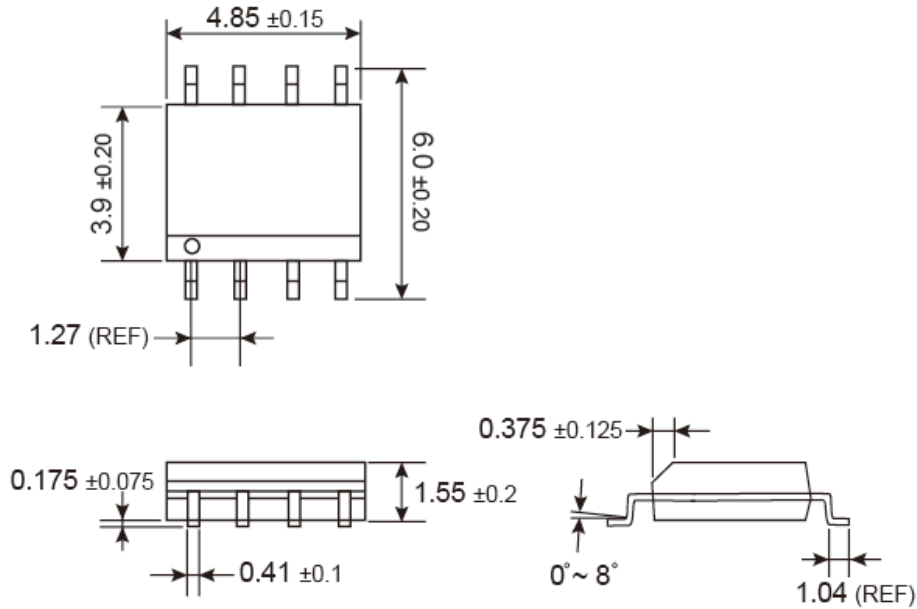

Unit: Millimeters

Marking Diagram

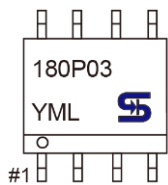

- Y** = Year Code
- M** = Month Code for Halogen Free Product
 (O=Jan, P=Feb, Q=Mar, R=Apr, S=May, T=Jun, U=Jul, V=Aug, W=Sep, X=Oct, Y=Nov, Z=Dec)
- L** = Lot Code

Notice

Specifications of the products displayed herein are subject to change without notice. TSC or anyone on its behalf, assumes no responsibility or liability for any errors or inaccuracies.

Information contained herein is intended to provide a product description only. No license, express or implied, to any intellectual property rights is granted by this document. Except as provided in TSC's terms and conditions of sale for such products, TSC assumes no liability whatsoever, and disclaims any express or implied warranty, relating to sale and/or use of TSC products including liability or warranties relating to fitness for a particular purpose, merchantability, or infringement of any patent, copyright, or other intellectual property right.

The products shown herein are not designed for use in medical, life-saving, or life-sustaining applications. Customers using or selling these products for use in such applications do so at their own risk and agree to fully indemnify TSC for any damages resulting from such improper use or sale.

Компания «Life Electronics» занимается поставками электронных компонентов импортного и отечественного производства от производителей и со складов крупных дистрибьюторов Европы, Америки и Азии.

С конца 2013 года компания активно расширяет линейку поставок компонентов по направлению коаксиальный кабель, кварцевые генераторы и конденсаторы (керамические, пленочные, электролитические), за счёт заключения дистрибьюторских договоров

Мы предлагаем:

- Конкурентоспособные цены и скидки постоянным клиентам.
- Специальные условия для постоянных клиентов.
- Подбор аналогов.
- Поставку компонентов в любых объемах, удовлетворяющих вашим потребностям.
- Приемлемые сроки поставки, возможна ускоренная поставка.
- Доставку товара в любую точку России и стран СНГ.
- Комплексную поставку.
- Работу по проектам и поставку образцов.
- Формирование склада под заказчика.
- Сертификаты соответствия на поставляемую продукцию (по желанию клиента).
- Тестирование поставляемой продукции.
- Поставку компонентов, требующих военную и космическую приемку.
- Входной контроль качества.
- Наличие сертификата ISO.

В составе нашей компании организован Конструкторский отдел, призванный помогать разработчикам, и инженерам.

Конструкторский отдел помогает осуществить:

- Регистрацию проекта у производителя компонентов.
- Техническую поддержку проекта.
- Защиту от снятия компонента с производства.
- Оценку стоимости проекта по компонентам.
- Изготовление тестовой платы монтаж и пусконаладочные работы.



Тел: +7 (812) 336 43 04 (многоканальный)
Email: org@lifeelectronics.ru