

**FEATURES**
**Dual output frequency range**
 $f_{OUT} = 8.71 \text{ GHz to } 9.55 \text{ GHz}$ 
 $f_{OUT/2} = 4.355 \text{ GHz to } 4.775 \text{ GHz}$ 
**Output power ( $P_{OUT}$ ): 11 dBm**
**Single-sideband (SSB) phase noise:  $-115 \text{ dBc/Hz}$  at 100 kHz**
**No external resonator needed**
**RoHS-compliant, 5 mm × 5 mm, 32-lead LFCSP: 25 mm<sup>2</sup>**
**APPLICATIONS**
**Point to point and multipoint radios**
**Test equipment and industrial controls**
**Very small aperture terminals (VSATs)**
**GENERAL DESCRIPTION**

The **HMC1161** is a monolithic microwave integrated circuit (MMIC), voltage controlled oscillator (VCO) that integrates a resonator, a negative resistance device, and a varactor diode, and features a half frequency output.

**FUNCTIONAL BLOCK DIAGRAM**

Figure 1.

13882-001

Because of the monolithic construction of the oscillator, the output power and phase noise performance are excellent over temperature.

The output power is 11 dBm typical from a 5 V supply voltage. The VCO is housed in a RoHS-compliant LFCSP and requires no external matching components.

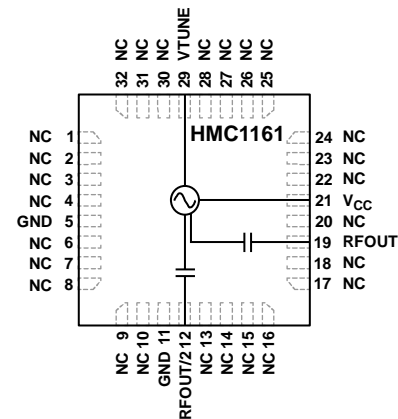
**TABLE OF CONTENTS**

Features .....	1	Interface Schematics .....	6
Applications.....	1	Typical Performance Characteristics .....	7
Functional Block Diagram .....	1	Applications Information .....	9
General Description .....	1	Evaluation Printed Circuit Board (PCB).....	10
Revision History .....	2	Bill of Materials.....	10
Specifications.....	3	Packaging and Ordering Information .....	11
Absolute Maximum Ratings .....	4	Outline Dimensions.....	11
ESD Caution.....	4	Ordering Guide .....	11
Pin Configuration and Function Descriptions.....	5		

**REVISION HISTORY**

**11/15—Rev. A to Rev. B**

Changes to Figure 3 and Figure 4.....	6
Changes to Ordering Guide, Note 1.....	11

**8/15—Revision A: Initial Version**

This Hittite Microwave Products data sheet has been reformatted to meet the styles and standards of Analog Devices, Inc.

## SPECIFICATIONS

$T_A = -40^{\circ}\text{C}$  to  $+85^{\circ}\text{C}$ ,  $V_{CC} = 5\text{ V}$ , unless otherwise noted.

Table 1.

Parameter	Min	Typ	Max	Unit	Test Conditions/Comments
<b>FREQUENCY</b>					
Range					
Output Frequency ( $f_{OUT}$ )	8.71		9.55	GHz	
Half Output Frequency ( $f_{OUT}/2$ )	4.355		4.755	GHz	
Drift Rate		0.75		MHz/ $^{\circ}\text{C}$	
Pulling		3.5		MHz p-p	Pulling into a 2.0:1 voltage standing wave ratio (VSWR)
Pushing		2		MHz/V	At VTUNE = 5 V
<b>OUTPUT POWER (<math>P_{OUT}</math>)</b>					
RFOUT	8	11	16	dBm	
RFOUT/2	0	4	8	dBm	
Supply Current ( $I_{CC}$ )		230		mA	$V_{CC} = 4.75\text{ V}$
	200	250	300	mA	$V_{CC} = 5.00\text{ V}$
		270		mA	$V_{CC} = 5.25\text{ V}$
<b>HARMONICS, SUBHARMONICS</b>					
1/2		23		dBc	
3/2		40		dBc	
Second		20		dBc	
Third		30		dBc	
<b>TUNING</b>					
Voltage (VTUNE)	2		13	V	
Sensitivity	50		250	MHz/V	
Tune Port Leakage Current			10	$\mu\text{A}$	VTUNE = 13 V
<b>OUTPUT RETURN LOSS</b>					
		2.5		dB	
<b>SSB PHASE NOISE</b>					
10 kHz Offset		-90	-83	dBc/Hz	
100 kHz Offset		-115	-109	dBc/Hz	

**ABSOLUTE MAXIMUM RATINGS**

Table 2.

Parameter	Rating
V <sub>CC</sub>	5.5 V dc
VTUNE	0 V to 15 V
Temperature	
Operating	–40°C to +85°C
Storage	–65°C to +150°C
Nominal Junction (to Maintain 1 Million Hours Mean Time to Failure (MTTF))	135°C
Nominal Junction (T <sub>A</sub> = 85°C)	126.7°C
Maximum Reflow Temperature (MSL3 Rating)	260°C
Thermal Resistance (Junction to Ground Paddle)	31.4°C/W
ESD Sensitivity (Human Body Model)	Class 1A

Stresses at or above those listed under Absolute Maximum Ratings may cause permanent damage to the product. This is a stress rating only; functional operation of the product at these or any other conditions above those indicated in the operational section of this specification is not implied. Operation beyond the maximum operating conditions for extended periods may affect product reliability.

**ESD CAUTION****ESD (electrostatic discharge) sensitive device.**

Charged devices and circuit boards can discharge without detection. Although this product features patented or proprietary protection circuitry, damage may occur on devices subjected to high energy ESD. Therefore, proper ESD precautions should be taken to avoid performance degradation or loss of functionality.

## PIN CONFIGURATION AND FUNCTION DESCRIPTIONS

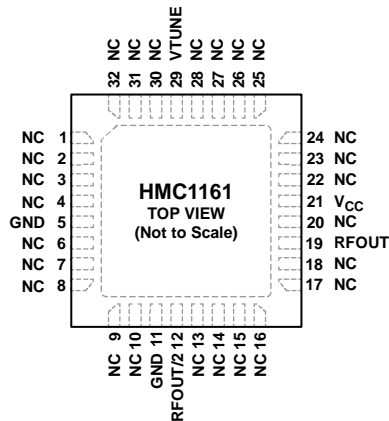

- NOTES**
1. NC = NO CONNECT. HOWEVER, THESE PINS CAN BE CONNECTED TO RF/DC GROUND WITHOUT AFFECTING THE PERFORMANCE OF THE DEVICE.
  2. EXPOSED PAD. THE PACKAGE BOTTOM HAS AN EXPOSED METAL PAD THAT MUST BE CONNECTED TO RF/DC GROUND.

13382-002

Figure 2. Pin Configuration

Table 3. Pin Function Descriptions

Pin No.	Mnemonic	Description
1 to 4, 6 to 10, 13 to 18, 20, 22 to 28, 30 to 32	NC	No Connect. However, these pins can be connected to RF/dc ground without affecting the performance of the device.
5, 11	GND	Ground. These pins must be connected to RF/dc ground.
12	RFOUT/2	Half Frequency Output. This pin is ac-coupled.
19	RFOUT	RF Output. This pin is ac-coupled.
21	V <sub>CC</sub>	Supply Voltage (5 V).
29	VTUNE	Control Voltage and Modulation Input. The modulation bandwidth is dependent on the drive source impedance.
	EP	Exposed Pad. The package bottom has an exposed metal pad that must be connected to RF/dc ground.

INTERFACE SCHEMATICS

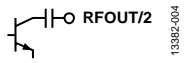

Figure 3. RFOUT/2 Interface

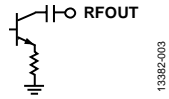

Figure 4. RFOUT Interface

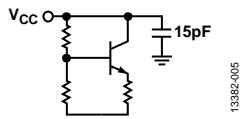

Figure 5. VCC Interface

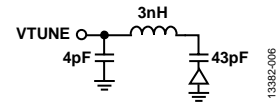

Figure 6. VTUNE Interface



Figure 7. GND Interface

# TYPICAL PERFORMANCE CHARACTERISTICS

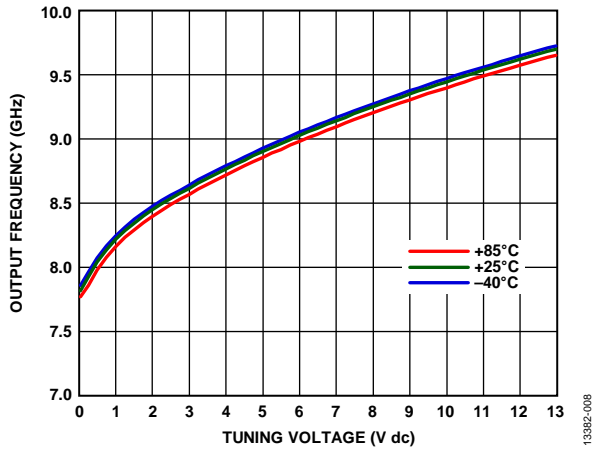

Figure 8. Output Frequency vs. Tuning Voltage

13382-008

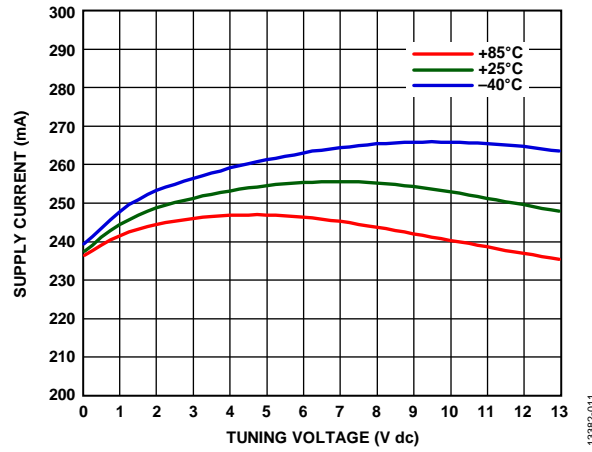

Figure 11. Supply Current ( $I_{cc}$ ) vs. Tuning Voltage

13382-011

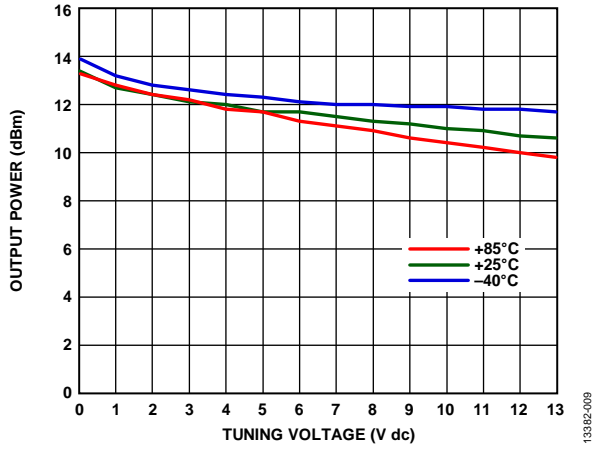

Figure 9. Output Power vs. Tuning Voltage

13382-009

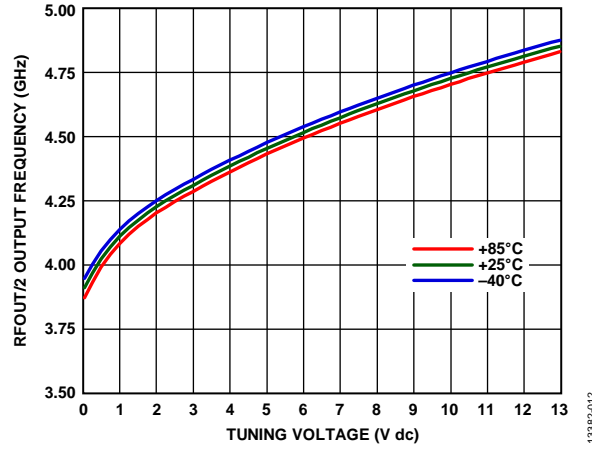

Figure 12. RFOUT/2 Output Frequency vs. Tuning Voltage

13382-012

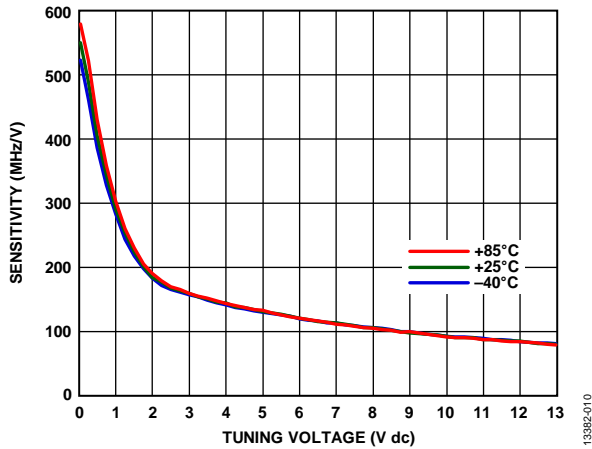

Figure 10. Sensitivity vs. Tuning Voltage

13382-010

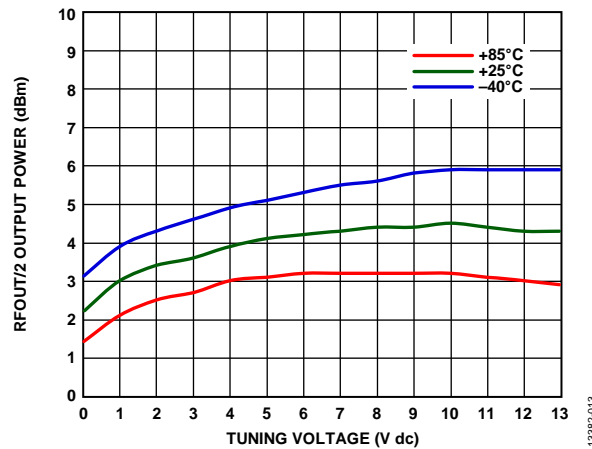

Figure 13. RFOUT/2 Output Power vs. Tuning Voltage

13382-013

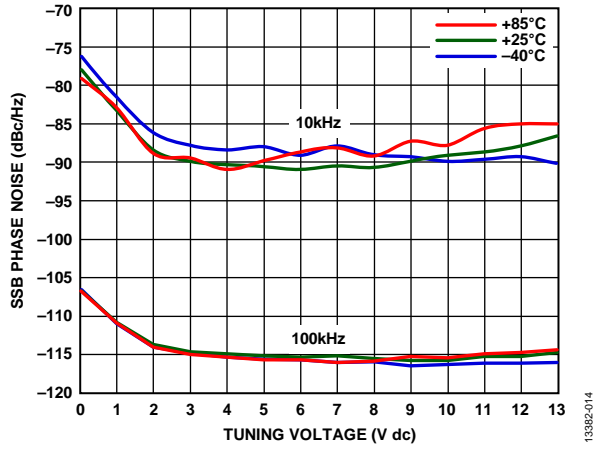

Figure 14. SSB Phase Noise vs. Tuning Voltage

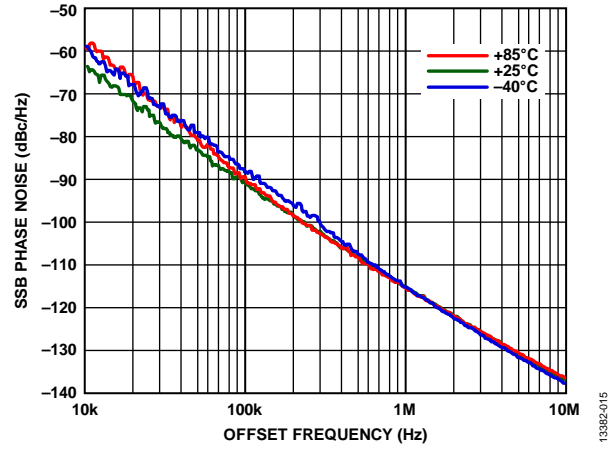

Figure 15. SSB Phase Noise vs. Offset Frequency at VTUNE = 5 V



## APPLICATIONS INFORMATION

The HMC1161 serves as the local oscillator (LO) in microwave synthesizer applications. The primary applications are point-to-point microwave radios, military, radars, test and measurement, as well as industrial and medical equipment. The low phase noise allows higher orders of modulation and offers improved bit error rates in communication systems, whereas the linear,

monotonic tuning sensitivity allows a stable loop filter design. The higher output power minimizes the gain required to drive subsequent stages. The half frequency output reduces the input frequency to the prescaler without the addition of residual phase noise to the input of the phase-locked loop synthesizer.

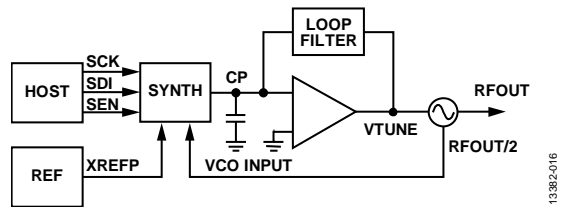

Figure 16. Typical Application Diagram

## EVALUATION PRINTED CIRCUIT BOARD (PCB)

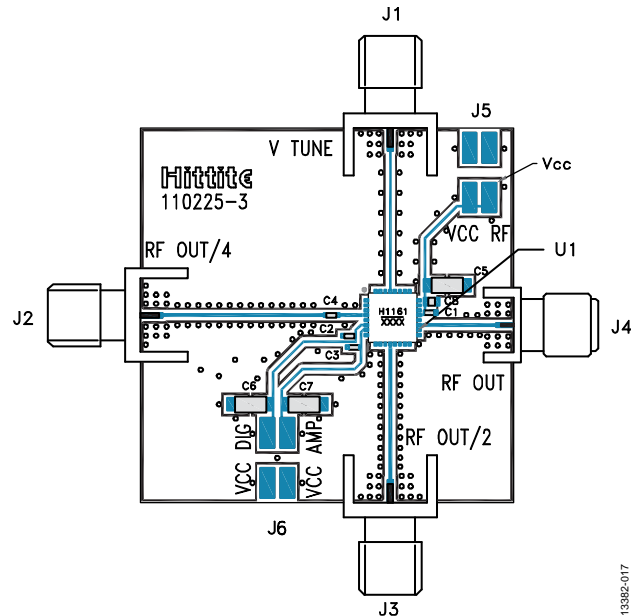

Figure 17. Evaluation PCB

The circuit board used in an application uses RF circuit design techniques. Ensure that the signal lines have  $50\ \Omega$  impedance and that the package ground leads and backside ground paddle are connected directly to the ground plane.

Use a sufficient number of via holes to connect the top and bottom ground planes. The evaluation circuit board shown in Figure 17 is available from Analog Devices, Inc., upon request.

## BILL OF MATERIALS

Table 4. Bill of Materials for the [EV1HMC1161LP5](#)

Item	Description
J1 to J4	PCB mount SMA RF connectors
J5, J6	2 mm dc headers
C1 to C3	100 pF capacitors, 0402 package
C4	1000 pF capacitor, 0402 package
C5 to C7	2.2 $\mu$ F tantalum capacitors
C8	0.01 $\mu$ F capacitor, 0603 package
U1	<a href="#">HMC1161</a> VCO
PCB <sup>1</sup>	110225 evaluation board <sup>2</sup>

<sup>1</sup> Circuit board material is Rogers 4350.

<sup>2</sup> Reference this number when ordering the complete evaluation PCB.

# PACKAGING AND ORDERING INFORMATION

## OUTLINE DIMENSIONS

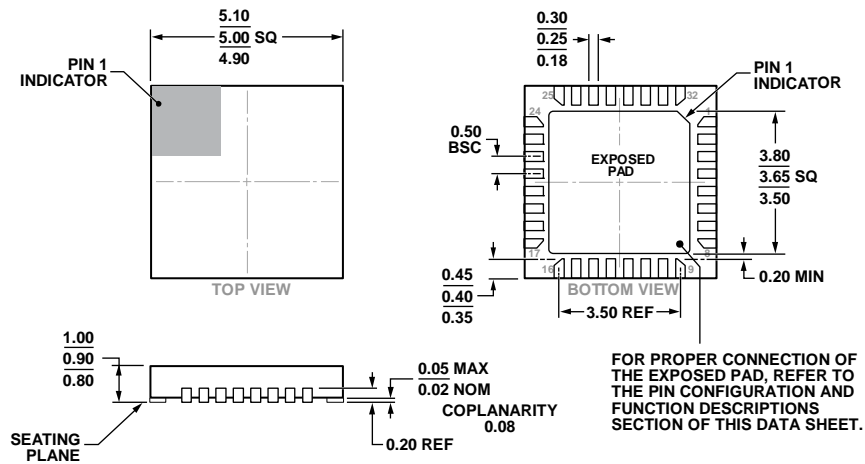

## ORDERING GUIDE

Model <sup>1</sup>	Temperature Range	MSL Rating <sup>2</sup>	Package Description	Package Option	Qty.	Branding <sup>3</sup>
HMC1161LP5E	-40°C to +85°C	MSL3	32-Lead LFCSP_VQ	HCP-32-1		H1161 XXXX
HMC1161LP5ETR	-40°C to +85°C	MSL3	32-Lead LFCSP_VQ, 7" Tape and Reel	HCP-32-1	500	H1161 XXXX
EV1HMC1161LP5			Evaluation Board			

<sup>1</sup> The HMC1161LP5E and HMC1161LP5ETR are RoHS compliant parts.

<sup>2</sup> See the Absolute Maximum Ratings section, Table 2.

<sup>3</sup> XXXX is a placeholder for the 4-digit lot number.

Компания «Life Electronics» занимается поставками электронных компонентов импортного и отечественного производства от производителей и со складов крупных дистрибьюторов Европы, Америки и Азии.

С конца 2013 года компания активно расширяет линейку поставок компонентов по направлению коаксиальный кабель, кварцевые генераторы и конденсаторы (керамические, пленочные, электролитические), за счёт заключения дистрибьюторских договоров

Мы предлагаем:

- Конкурентоспособные цены и скидки постоянным клиентам.
- Специальные условия для постоянных клиентов.
- Подбор аналогов.
- Поставку компонентов в любых объемах, удовлетворяющих вашим потребностям.
- Приемлемые сроки поставки, возможна ускоренная поставка.
- Доставку товара в любую точку России и стран СНГ.
- Комплексную поставку.
- Работу по проектам и поставку образцов.
- Формирование склада под заказчика.
- Сертификаты соответствия на поставляемую продукцию (по желанию клиента).
- Тестирование поставляемой продукции.
- Поставку компонентов, требующих военную и космическую приемку.
- Входной контроль качества.
- Наличие сертификата ISO.

В составе нашей компании организован Конструкторский отдел, призванный помогать разработчикам, и инженерам.

Конструкторский отдел помогает осуществить:

- Регистрацию проекта у производителя компонентов.
- Техническую поддержку проекта.
- Защиту от снятия компонента с производства.
- Оценку стоимости проекта по компонентам.
- Изготовление тестовой платы монтаж и пусконаладочные работы.



Тел: +7 (812) 336 43 04 (многоканальный)

Email: [org@lifeelectronics.ru](mailto:org@lifeelectronics.ru)