

High Precision Bulk Metal[®] Foil Surface Mount Current Sensing Chip Resistor with TCR of $\pm 2 \text{ ppm}/^\circ\text{C}$ and Load Life Stability of $\pm 0.02 \%$

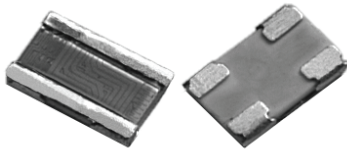

INTRODUCTION

Model VCS1625 is a surface mount resistor designed with 4 pads for Kelvin connection. Utilizing Vishay Bulk Metal[®] foil as the resistance element, it provides performance capabilities far greater than other resistor technologies can supply in a product of comparable size.

This small device dissipates heat almost entirely through the pads so surface mount users are encouraged to be generous with the board's pads and traces. Gold terminations are available on special order.

Our application engineering department is available to advise and to make recommendations. For non standard technical requirements and special applications, please contact us.

FEATURES

- Temperature coefficient of resistance (TCR): $\pm 2.0 \text{ ppm}/^\circ\text{C}$ typical (- 55 °C to + 125 °C, + 25 °C ref.) (see table 1)
- Resistance range: 0.01 Ω to 10 Ω (for higher or lower values please contact us)
- Vishay Foil resistors are not restricted to standard values, we can supply specific "as required" values at no extra cost or delivery (e.g. 1.2345 Ω vs. 1 Ω)
- Tolerance: to $\pm 0.1 \%$
- Load life stability: $\pm 0.02 \%$ at 70 °C, 2000 h at rated power
- Electrostatic discharge (ESD) up to 25 000 V
- Short time overload $\leq 0.005 \%$
- Non inductive, non capacitive design
- Power rating: 0.5 W at + 70 °C (figure 1) or 5 A, whichever is lower
- Thermal EMF: 0.05 $\mu\text{V}/^\circ\text{C}$ typical
- Non hot spot design
- Current noise: < - 40 dB
- Rise time: 1 ns effectively no ringing
- Voltage coefficient: < 0.1 ppm/V
- Non inductive: < 0.08 μH
- For better performances please review VCS1625Z (Z-foil) datasheet



RoHS*
COMPLIANT

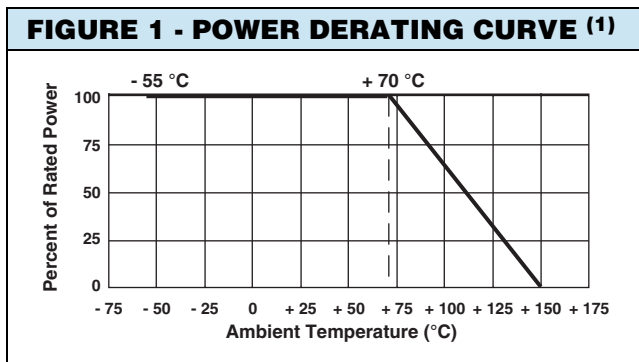

Note

(1) Power rating at + 70 °C: 0.5 W on FR4 PCB

TERMINATIONS

- Two lead (Pb)-free options are available: gold plated or tin plated
- Tin/lead plated

APPLICATIONS

- Automatic test equipment (ATE)
- Airborne (in heads-up display systems)
- High precision instrumentation
- Electron beam recording equipment
- Electron microscopes
- Current sensing applications
- Forced balance electronic scales
- Applications that require superior frequency stability
- Military
- Medical

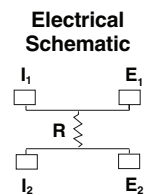

TABLE 1 - TOLERANCE AND TCR VS. RESISTANCE VALUE (- 55 °C to + 125 °C, + 25° Ref.)			
VALUE (Ω)	TOLERANCE	TYPICAL TCR	MAXIMUM TCR
> 2R000 to 10R000	0.2 %, 0.5 %, 1 %	$\pm 2 \text{ ppm}/^\circ\text{C}$	$\pm 5 \text{ ppm}/^\circ\text{C}$
> 0R500 to 2R000	0.5 %, 1 %	$\pm 2 \text{ ppm}/^\circ\text{C}$	$\pm 10 \text{ ppm}/^\circ\text{C}$
> 0R100 to 0R500	1 %	$\pm 2 \text{ ppm}/^\circ\text{C}$	$\pm 15 \text{ ppm}/^\circ\text{C}$
> 0R050 to 0R100	1 %	$\pm 2 \text{ ppm}/^\circ\text{C}$	$\pm 20 \text{ ppm}/^\circ\text{C}$
> 0R030 to 0R050	1 %	$\pm 2 \text{ ppm}/^\circ\text{C}$	$\pm 30 \text{ ppm}/^\circ\text{C}$
> 0R010 to 0R030	1 %	$\pm 2 \text{ ppm}/^\circ\text{C}$	$\pm 50 \text{ ppm}/^\circ\text{C}$

* Pb containing materials are not RoHS compliant, exemptions may apply

FIGURE 2 - DIMENSIONS in Inches (Millimeters)

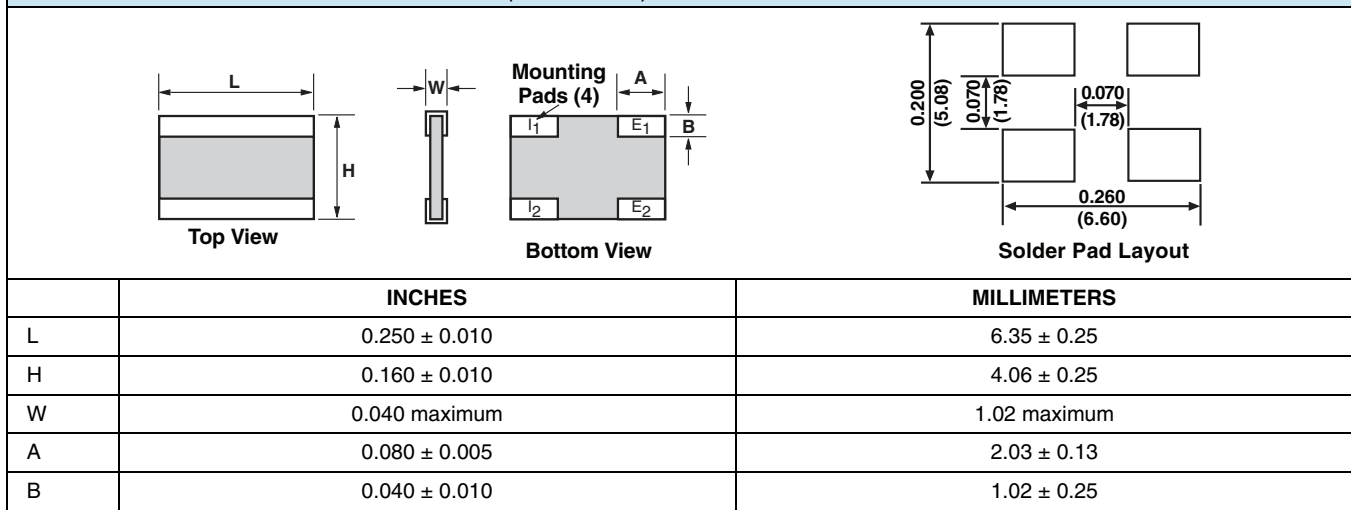

FIGURE 1 - TRIMMING TO VALUES
(Conceptual Illustration)

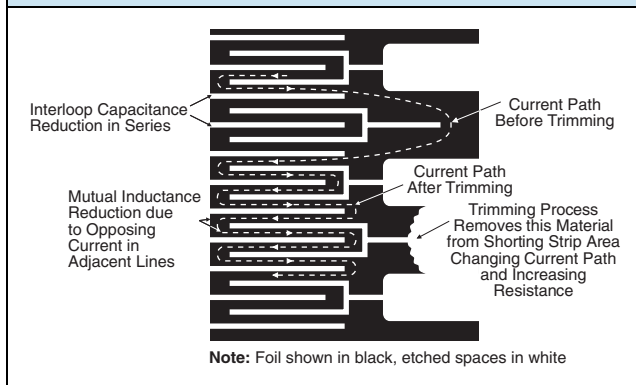

FIGURE 4 - TYPICAL TCR CURVE

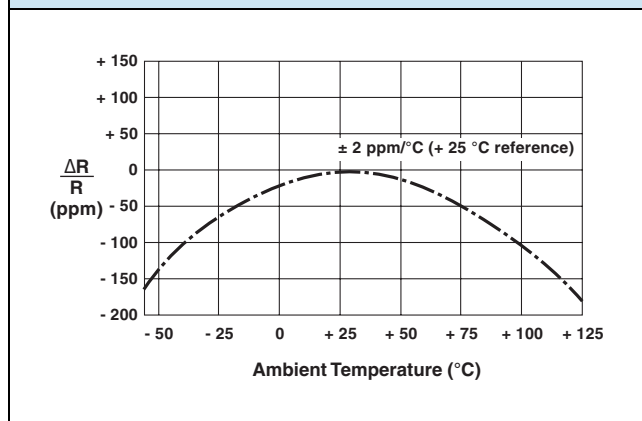

TABLE 2 - PERFORMANCE SPECIFICATIONS

TEST	MIL-PRF-55342 ΔR LIMITS	TYPICAL ΔR LIMITS	MAXIMUM ΔR LIMITS
Thermal Shock 5 x (- 65 °C to + 150 °C)	± 0.10 %	± 0.005 % (50 ppm)	± 0.01 % (100 ppm)
Low Temperature Operation	± 0.10 %	± 0.005 % (50 ppm)	± 0.01 % (100 ppm)
Short Time Overload	± 0.10 %	± 0.005 % (50 ppm)	± 0.02 % (200 ppm)
High Temperature Exposure	± 0.10 %	± 0.01 % (100 ppm)	± 0.02 % (200 ppm)
Resistance to Soldering Heat	± 0.2 %	± 0.01 % (100 ppm)	± 0.03 % (300 ppm)
Moisture Resistance	± 0.20 %	± 0.01 % (100 ppm)	± 0.03 % (300 ppm)
Load Life 2000 h at 70 °C: Rated Power On Ceramic PCB	± 0.5 %	± 0.02 % (200 ppm)	± 0.04 % (400 ppm)

Note

- Measurement error 0.001R

TABLE 3 - GLOBAL PART NUMBER INFORMATION

NEW GLOBAL PART NUMBER: Y08501R50500D9L (preferred part number format)

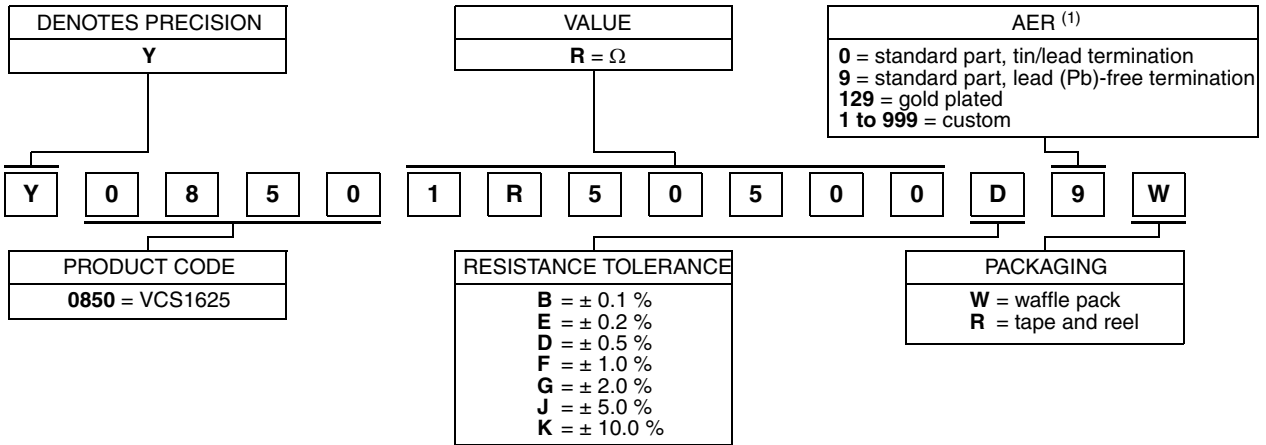

FOR EXAMPLE: ABOVE GLOBAL ORDER Y0850 1R50500 D 9 W:
 TYPE: VCS1625
 VALUES: 1.505 Ω
 ABSOLUTE TOLERANCE: ± 0.5 %
 TERMINATION: tin plated (lead (Pb)-free)
 PACKAGING: bulk pack

HISTORICAL PART NUMBER: VCS1625 1R5050 TCR2 D S W (will continue to be used)

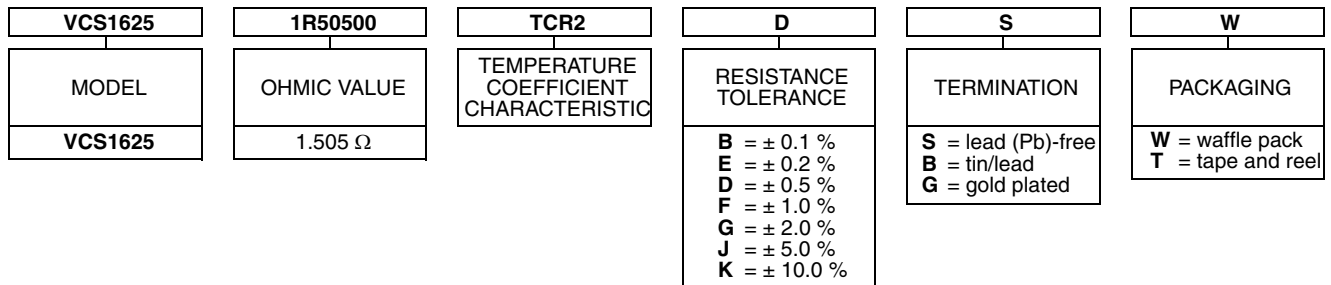

Note

(1) For non-standard requests or additional values, please contact application engineering.

Disclaimer

ALL PRODUCTS, PRODUCT SPECIFICATIONS AND DATA ARE SUBJECT TO CHANGE WITHOUT NOTICE.

Vishay Precision Group, Inc., its affiliates, agents, and employees, and all persons acting on its or their behalf (collectively, "Vishay Precision Group"), disclaim any and all liability for any errors, inaccuracies or incompleteness contained herein or in any other disclosure relating to any product.

The product specifications do not expand or otherwise modify Vishay Precision Group's terms and conditions of purchase, including but not limited to, the warranty expressed therein.

Vishay Precision Group makes no warranty, representation or guarantee other than as set forth in the terms and conditions of purchase. **To the maximum extent permitted by applicable law, Vishay Precision Group disclaims (i) any and all liability arising out of the application or use of any product, (ii) any and all liability, including without limitation special, consequential or incidental damages, and (iii) any and all implied warranties, including warranties of fitness for particular purpose, non-infringement and merchantability.**

Information provided in datasheets and/or specifications may vary from actual results in different applications and performance may vary over time. Statements regarding the suitability of products for certain types of applications are based on Vishay Precision Group's knowledge of typical requirements that are often placed on Vishay Precision Group products. It is the customer's responsibility to validate that a particular product with the properties described in the product specification is suitable for use in a particular application.

No license, express, implied, or otherwise, to any intellectual property rights is granted by this document, or by any conduct of Vishay Precision Group.

The products shown herein are not designed for use in life-saving or life-sustaining applications unless otherwise expressly indicated. Customers using or selling Vishay Precision Group products not expressly indicated for use in such applications do so entirely at their own risk and agree to fully indemnify Vishay Precision Group for any damages arising or resulting from such use or sale. Please contact authorized Vishay Precision Group personnel to obtain written terms and conditions regarding products designed for such applications.

Product names and markings noted herein may be trademarks of their respective owners.

Компания «Life Electronics» занимается поставками электронных компонентов импортного и отечественного производства от производителей и со складов крупных дистрибьюторов Европы, Америки и Азии.

С конца 2013 года компания активно расширяет линейку поставок компонентов по направлению коаксиальный кабель, кварцевые генераторы и конденсаторы (керамические, пленочные, электролитические), за счёт заключения дистрибьюторских договоров

Мы предлагаем:

- Конкурентоспособные цены и скидки постоянным клиентам.
- Специальные условия для постоянных клиентов.
- Подбор аналогов.
- Поставку компонентов в любых объемах, удовлетворяющих вашим потребностям.
- Приемлемые сроки поставки, возможна ускоренная поставка.
- Доставку товара в любую точку России и стран СНГ.
- Комплексную поставку.
- Работу по проектам и поставку образцов.
- Формирование склада под заказчика.
- Сертификаты соответствия на поставляемую продукцию (по желанию клиента).
- Тестирование поставляемой продукции.
- Поставку компонентов, требующих военную и космическую приемку.
- Входной контроль качества.
- Наличие сертификата ISO.

В составе нашей компании организован Конструкторский отдел, призванный помогать разработчикам, и инженерам.

Конструкторский отдел помогает осуществить:

- Регистрацию проекта у производителя компонентов.
- Техническую поддержку проекта.
- Защиту от снятия компонента с производства.
- Оценку стоимости проекта по компонентам.
- Изготовление тестовой платы монтаж и пусконаладочные работы.



Тел: +7 (812) 336 43 04 (многоканальный)

Email: org@lifeelectronics.ru