

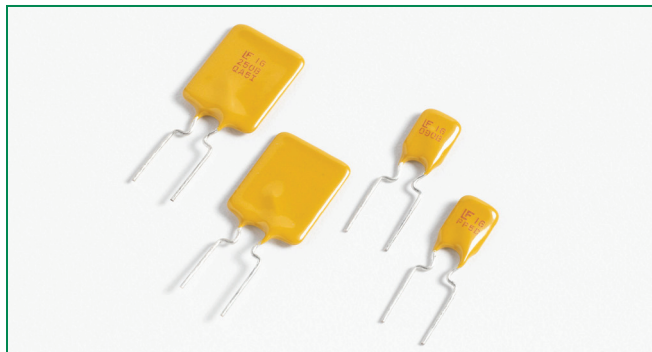

**RoHS (Pb) HF 16R Series**

**Description**

Littelfuse 16R Series Radial Leaded PTCs are designed to provide resettable overcurrent protection serving a wide range of electronics applications. With maximum 16 volts and maximum 100-ampere short circuit rating, they offer an ideal solution for USB protection.

**Features**

- 100A short circuit rating
- 16V Operating voltages
- Fast time-to-trip
- Meets all USB protection requirements
- RoHS compliant, Lead-Free and Halogen-Free\*



**Agency Approvals**

AGENCY	AGENCY FILE NUMBER
	E183209
	R50119318

**Applications**

- Computers & peripherals
- Any USB application
- General Electronics

**Electrical Characteristics**

Part Number	I <sub>hold</sub> (A)	I <sub>trip</sub> (A)	V <sub>max</sub> (Vdc)	I <sub>max</sub> (A)	P <sub>d</sub> typ. (W)	Maximum Time To Trip		Resistance		Agency Approvals	
						Current (A)	Time (Sec.)	R <sub>min</sub> (Ω)	R <sub>1max</sub> (Ω)		
16R250G	2.5	4.7	16	100	1.0	12.5	5.0	0.0220	0.0530	X	X
16R300G	3.0	5.1	16	100	2.3	15.0	1.0	0.0380	0.0975	X	X
16R400G	4.0	6.8	16	100	2.4	20.0	1.7	0.0210	0.0600	X	X
16R500G	5.0	8.5	16	100	2.6	25.0	2.0	0.0150	0.0340	X	X
16R600G	6.0	10.2	16	100	2.8	30.0	3.3	0.0100	0.0280	X	X
16R700G	7.0	11.9	16	100	3.0	35.0	3.5	0.0077	0.0200	X	X
16R800G	8.0	13.6	16	100	3.0	40.0	5.0	0.0056	0.0175	X	X
16R900G	9.0	15.3	16	100	3.3	45.0	5.5	0.0047	0.0135	X	X
16R1000G	10.0	17.0	16	100	3.6	50.0	6.0	0.0040	0.0102	X	X
16R1100G	11.0	18.7	16	100	3.7	55.0	7.0	0.0037	0.0089	X	X
16R1200G	12.0	20.4	16	100	4.2	60.0	7.5	0.0033	0.0086	X	X
16R1400G	14.0	23.8	16	100	4.6	70.0	9.0	0.0026	0.0064	X	X

I<sub>hold</sub> = Hold current: maximum current device will pass without tripping in 23°C still air.

I<sub>trip</sub> = Trip current: minimum current at which the device will trip in 23°C still air.

V<sub>max</sub> = Maximum voltage device can withstand without damage at rated current (I<sub>max</sub>)

I<sub>max</sub> = Maximum fault current device can withstand without damage at rated voltage (V<sub>max</sub>)

P<sub>d</sub> = Power dissipated from device when in the tripped state at 23°C still air.

R<sub>min</sub> = Minimum resistance of device in initial (un-soldered) state.

R<sub>1max</sub> = Maximum resistance of device at 23°C measured one hour after tripping.

**Caution:** Operation beyond the specified rating may result in damage and possible arcing and flame.

\* Effective January 1, 2010, all 16R PTC products will be manufactured Halogen Free (HF). Existing Non-Halogen Free 16R PTC products may continue to be sold, until supplies are depleted.

**Temperature Derating**

Part Number	Ambient Operation Temperature								
	-40°C	-20°C	0°C	23°C	40°C	50°C	60°C	70°C	85°C
16R250G	3.7	3.3	2.9	2.5	2.2	2.0	1.8	1.6	1.3
16R300G	4.4	4.0	3.5	3.0	2.6	2.4	2.1	1.9	1.6
16R400G	5.9	5.3	4.7	4.0	3.5	3.2	2.9	2.6	2.1
16R500G	7.4	6.6	5.9	5.0	4.4	4.0	3.6	3.2	2.6
16R600G	8.9	8.0	7.1	6.0	5.2	4.8	4.3	3.9	3.2
16R700G	10.4	9.3	8.2	7.0	6.1	5.6	5.0	4.5	3.7
16R800G	11.8	10.6	9.4	8.0	7.0	6.3	5.7	5.1	4.2
16R900G	13.3	12.0	10.6	9.0	7.8	7.1	6.5	5.8	4.7
16R1000G	14.8	13.3	11.8	10.0	8.7	7.9	7.1	6.4	5.3
16R1100G	16.3	14.6	12.9	11.0	9.6	8.7	7.9	7.0	5.8
16R1200G	17.7	15.9	14.1	12.0	10.5	9.5	8.6	7.7	6.3
16R1400G	20.7	18.6	16.5	14.0	12.2	11.1	10.0	9.0	7.4

**Average Time Current Curves**

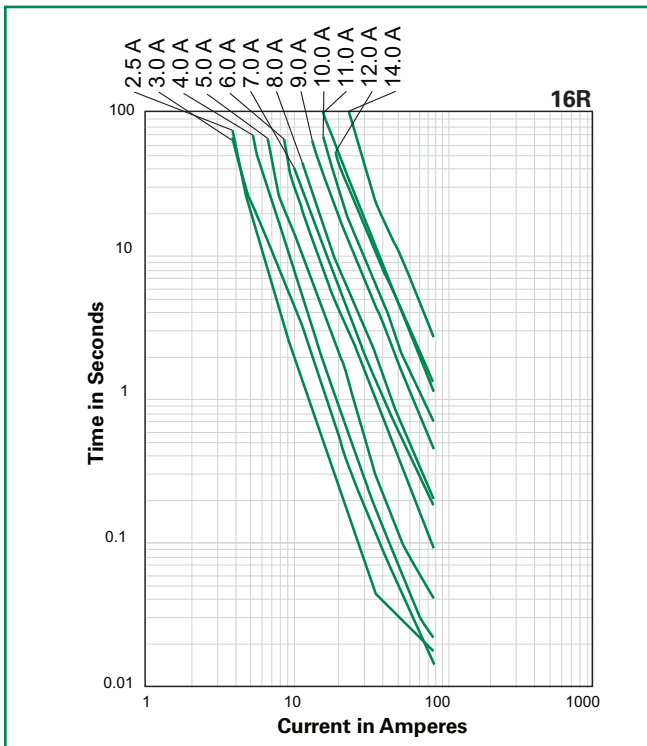

**Temperature Derating Curve**

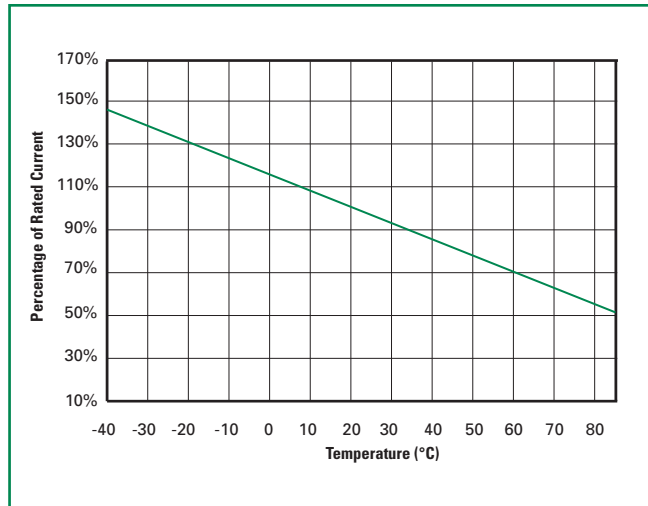

The average time current curves and Temperature Derating curve performance is affected by a number of variables, and these curves provided as guidance only. Customer must verify the performance in their application.

**Soldering Parameters - Wave Soldering**

<b>Pre-Heating Zone</b>	Refer to the condition recommended by the flux manufacturer. Max. ramping rate should not exceed 4°C/Sec.
<b>Soldering Zone</b>	Max. solder temperature should not exceed 260°C
<b>Cooling Zone</b>	Cooling by natural convection in air.

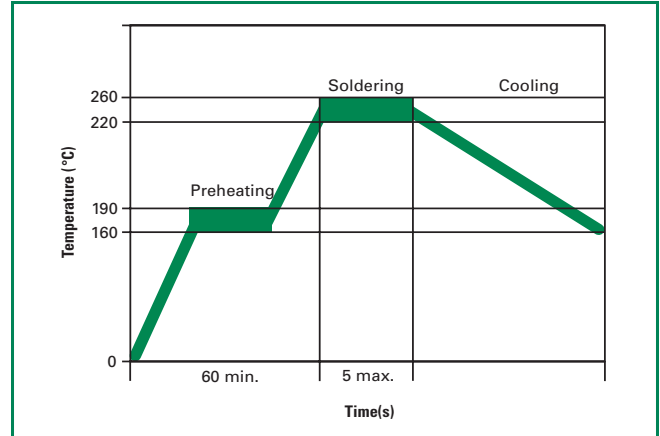

**Physical Specifications**

<b>Lead Material</b>	2.5A: Tin-plated Copper clad Steel 3.0 - 14.0A: Tin-plated Copper
<b>Soldering Characteristics</b>	Solderability per MIL-STD-202, Method 208E
<b>Insulating Material</b>	Cured, flame retardant epoxy polymer meets UL94V-0 requirements.
<b>Device Labeling</b>	Marked with 'LF', voltage, current rating, and date code.

**Environmental Specifications**

<b>Operating/Storage Temperature</b>	-40°C to +85°C
<b>Maximum Device Surface Temperature in Tripped State</b>	125°C
<b>Passive Aging</b>	+85°C, 1000 hours -/+ 5% typical resistance change
<b>Humidity Aging</b>	+85°C, 85% R.H., 1000 hours -/+ 5% typical resistance change
<b>Thermal Shock</b>	+85°C to -40°C 10 times -/+ 5% typical resistance change
<b>Solvent Resistance</b>	MIL-STD-202, Method 215F No change
<b>Moisture Resistance Level</b>	Level 1, J-STD-020C

**Dimensions**

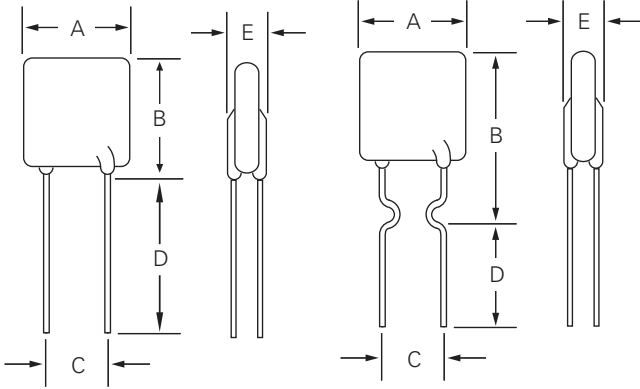

**Figure 1**

**Figure 2**

**Part Marking System**

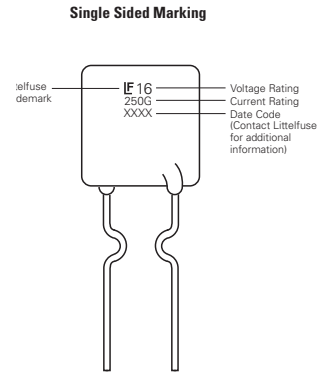

Part Number	Figure	A		B		C		D		E		Physical Characteristics		
		Inches	mm	Inches	mm	Inches	mm	Inches	mm	Inches	mm	Lead (dia)		Material
		Max.	Max.	Max.	Max.	Typ.	Typ.	Min.	Min.	Max.	Max.	Inches	mm	
16R250G	2	0.35	8.90	0.50	12.80	0.20	5.1	0.13	3.18	0.12	3.00	0.020	0.51	Sn/CuFe
16R300G	1	0.28	7.10	0.43	11.00	0.20	5.1	0.30	7.6	0.12	3.00	0.032	0.81	Sn/Cu
16R400G	1	0.35	8.90	0.50	12.80	0.20	5.1	0.30	7.6	0.12	3.00	0.032	0.81	Sn/Cu
16R500G	1	0.41	10.40	0.56	14.30	0.20	5.1	0.30	7.6	0.12	3.00	0.032	0.81	Sn/Cu
16R600G	1	0.42	10.70	0.67	17.10	0.20	5.1	0.30	7.6	0.12	3.00	0.032	0.81	Sn/Cu
16R700G	1	0.44	11.20	0.78	19.70	0.20	5.1	0.30	7.6	0.12	3.00	0.032	0.81	Sn/Cu
16R700GKL	2	0.44	11.20	0.93	23.70	0.20	5.1	0.30	7.6	0.12	3.00	0.032	0.81	Sn/Cu
16R800G	1	0.50	12.70	0.82	20.90	0.20	5.1	0.30	7.6	0.12	3.00	0.032	0.81	Sn/Cu
16R900G	1	0.55	14.00	0.85	21.70	0.20	5.1	0.30	7.6	0.12	3.00	0.032	0.81	Sn/Cu
16R1000G	1	0.65	16.50	0.99	25.20	0.20	5.1	0.30	7.6	0.12	3.00	0.032	0.81	Sn/Cu
16R1100G	1	0.69	17.50	1.02	26.00	0.20	5.1	0.30	7.6	0.12	3.00	0.032	0.81	Sn/Cu
16R1200G	1	0.69	17.50	1.10	28.00	0.40	10.2	0.30	7.6	0.14	3.50	0.039	1.00	Sn/Cu
16R1400G	1	0.93	23.50	1.10	27.90	0.40	10.2	0.30	7.6	0.14	3.50	0.039	1.00	Sn/Cu

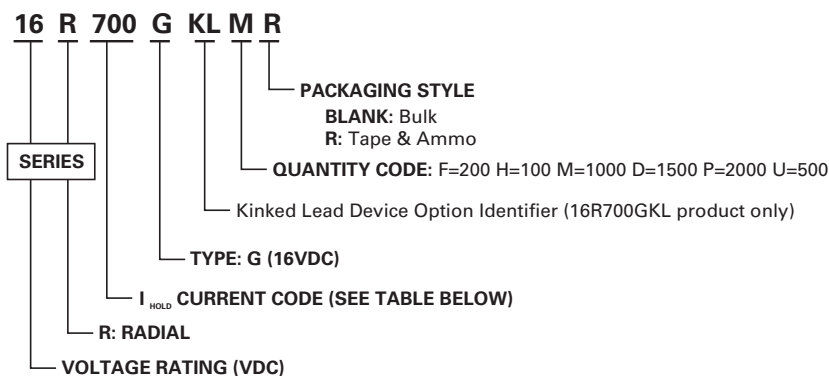
**Part Ordering Number System**

**Packaging Options**

Part Number	Ordering Number	I <sub>hold</sub> (A)	I <sub>hold</sub> Code	Packaging Option	Quantity	Quantity & Packaging Codes
16R250G	16R250GU	2.50	250	Bulk	500	U
	16R250GPR			Tape and Ammo	2000	PR
16R300G	16R300GU	3.00	300	Bulk	500	U
	16R300GPR			Tape and Ammo	2000	PR
16R400G	16R400GU	4.00	400	Bulk	500	U
	16R400GPR			Tape and Ammo	2000	PR
16R500G	16R500GU	5.00	500	Bulk	500	U
	16R500GPR			Tape and Ammo	2000	PR
16R600G	16R600GU	6.00	600	Bulk	500	U
	16R600GDR			Tape and Ammo	1500	DR
16R700G	16R700GF	7.00	700	Bulk	200	F
	16R700GKLF			Tape and Ammo	1000	MR
	16R700GMR					
	16R700GKLMR					
16R800G	16R800GF	8.00	800	Bulk	200	F
	16R800GMR			Tape and Ammo	1000	MR
16R900G	16R900GF	9.00	900	Bulk	200	F
	16R900GMR			Tape and Ammo	1000	MR
16R1000G	16R1000GF	10.00	1000	Bulk	200	F
	16R1000GMR			Tape and Ammo	1000	MR
16R1100G	16R1100GF	11.00	1100	Bulk	200	F
	16R1100GMR			Tape and Ammo	1000	MR
16R1200G	16R1200GH	12.00	1200	Bulk	100	H
	16R1200GMR			Tape and Ammo	1000	MR
16R1400G	16R1400GH	14.00	1400	Bulk	100	H

**Tape and Ammo Specifications**

Devices taped using EIA468-B/IE286-2 standards. See table below and Figure 1 for details.

Dimension	EIA Mark	IEC Mark	Dimensions	
			Dim. (mm)	Tol. (mm)
Carrier tape width	<b>W</b>	<b>W</b>	18	-0.5 /+1.0
Hold down tape width:	<b>W<sub>4</sub></b>	<b>W<sub>0</sub></b>	11	min.
Top distance between tape edges	<b>W<sub>6</sub></b>	<b>W<sub>2</sub></b>	3	max.
Sprocket hole position	<b>W<sub>5</sub></b>	<b>W<sub>1</sub></b>	9	-0.5 /+0.75
Sprocket hole diameter*	<b>D<sub>0</sub></b>	<b>D<sub>0</sub></b>	4	-0.32 /+0.2
Abscissa to plane(straight lead)	<b>H</b>	<b>H</b>	18.5	-/+ 3.0
Abscissa to plane(kinked lead)	<b>H<sub>0</sub></b>	<b>H<sub>0</sub></b>	16	-/+ 0.5
Abscissa to top			45.0	max.
Overall width w/o lead protrusion			56	max.
Overall width w/ lead protrusion			57	max.
Lead protrusion	<b>L<sub>1</sub></b>	<b>I<sub>1</sub></b>	1.0	max.
Protrusion of cut out	<b>L</b>	<b>L</b>	11	max.
Protrusion beyond hold-down tape	<b>I<sub>2</sub></b>	<b>I<sub>2</sub></b>	Not specified	
Sprocket hole pitch	<b>P<sub>0</sub></b>	<b>P<sub>0</sub></b>	25.4	-/+ 0.5
Device pitch:			25.4	
Pitch tolerance			20 consecutive.	-/+ 1
Tape thickness	<b>t</b>	<b>t</b>	0.9	max.
Tape thickness with splice	<b>t<sub>1</sub></b>		2.0	max.
Splice sprocket hole alignment			0	-/+ 0.3
Body lateral deviation	<b>Δh</b>	<b>Δh</b>	0	-/+ 1.0
Body tape plane deviation	<b>Δp</b>	<b>Δp</b>	0	-/+ 1.3
Ordinate to adjacent component lead*	<b>P<sub>1</sub></b>	<b>P<sub>1</sub></b>	3.81	-/+ 0.7
Ordinate to adjacent component lead*			7.62	-/+ 0.7
Lead spacing:16R250G-16R1100G	<b>F</b>	<b>F</b>	5.08	-/+ 0.8
Lead spacing:16R1200G-16R1400G	<b>F</b>	<b>F</b>	10.18	-/+ 0.8

\*Differs from EIA specification

**Tape and Ammo Diagram**

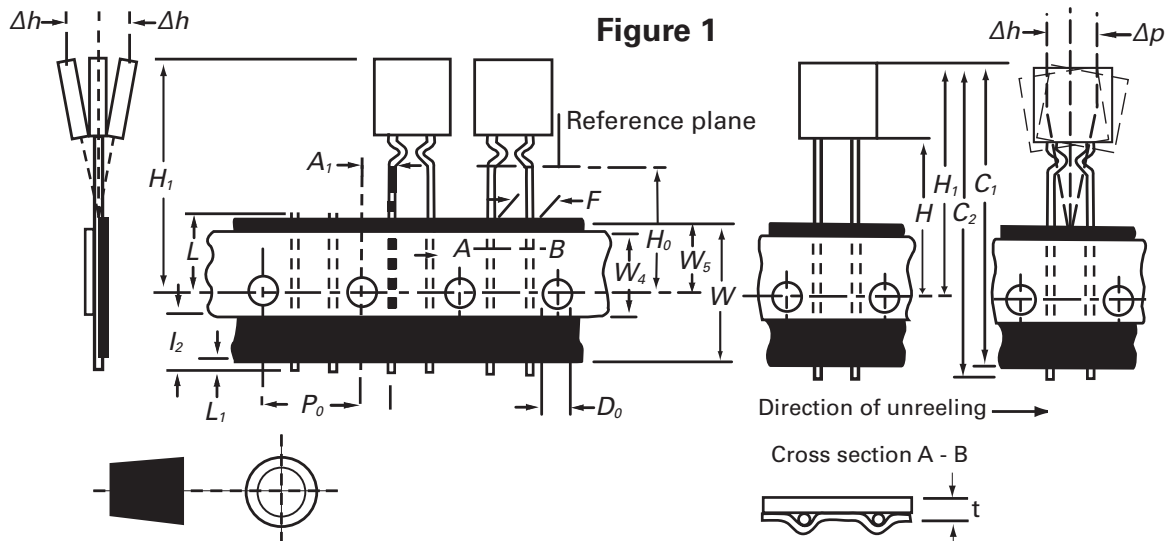

**Figure 1**

Компания «Life Electronics» занимается поставками электронных компонентов импортного и отечественного производства от производителей и со складов крупных дистрибьюторов Европы, Америки и Азии.

С конца 2013 года компания активно расширяет линейку поставок компонентов по направлению коаксиальный кабель, кварцевые генераторы и конденсаторы (керамические, пленочные, электролитические), за счёт заключения дистрибьюторских договоров

Мы предлагаем:

- Конкурентоспособные цены и скидки постоянным клиентам.
- Специальные условия для постоянных клиентов.
- Подбор аналогов.
- Поставку компонентов в любых объемах, удовлетворяющих вашим потребностям.
- Приемлемые сроки поставки, возможна ускоренная поставка.
- Доставку товара в любую точку России и стран СНГ.
- Комплексную поставку.
- Работу по проектам и поставку образцов.
- Формирование склада под заказчика.
- Сертификаты соответствия на поставляемую продукцию (по желанию клиента).
- Тестирование поставляемой продукции.
- Поставку компонентов, требующих военную и космическую приемку.
- Входной контроль качества.
- Наличие сертификата ISO.

В составе нашей компании организован Конструкторский отдел, призванный помогать разработчикам, и инженерам.

Конструкторский отдел помогает осуществить:

- Регистрацию проекта у производителя компонентов.
- Техническую поддержку проекта.
- Защиту от снятия компонента с производства.
- Оценку стоимости проекта по компонентам.
- Изготовление тестовой платы монтаж и пусконаладочные работы.



Тел: +7 (812) 336 43 04 (многоканальный)

Email: [org@lifeelectronics.ru](mailto:org@lifeelectronics.ru)