

LARISA-RS-CLIP16

~19° real spot beam. Clip fastening for 1.6 mm thick PCB

TECHNICAL SPECIFICATIONS:

Dimensions	9.9 mm
Height	7.5 mm
Fastening	clips
ROHS compliant	yes ⓘ

MATERIAL SPECIFICATIONS:

Component	Type	Material	Colour	Finish
LARISA-RS	Single lens	PMMA	clear	
LARISA-HOLDER-CLIP16	Holder	PC	black	



ORDERING INFORMATION:

Component		Qty in box	MOQ	MPQ	Box weight (kg)
CP12939_LARISA-RS-CLIP16	Single lens	10000	300	100	5.8
» Box size: 300 x 250 x 250 mm					

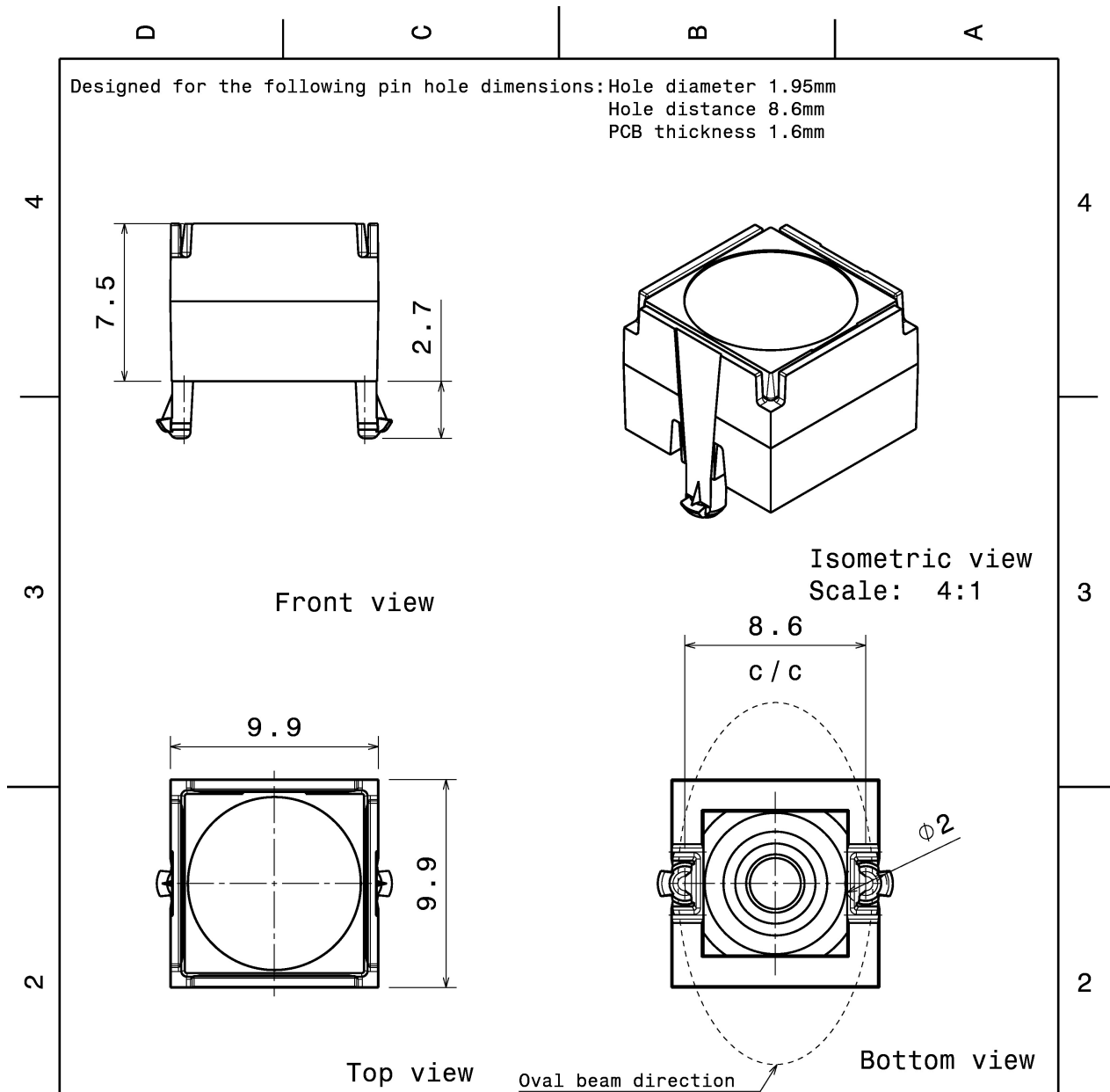

INDEX	PART NO	DESCRIPTION	MATERIAL	COLOUR
1	-	LARISA lens	PMMA	
2	C12908	LARISA-HOLDER-CLIP16	PC	black

Tolerances if not otherwise shown
According to DIN ISO 2768-1
Linear measures:
Up to 30mm class M, otherwise class C.
According to DIN ISO 2768-2
Form and position: class L

LEDiL

Ledil Oy
Salorankatu 10
FIN 24240 SALO
Finland

THIRD ANGLE PROJECTION:

DRAWING TITLE

LARISA-CLIP16 series

This drawing is the property of LEDiL Oy. It may not be reproduced, copied or communicated without a written agreement with LEDiL Oy.

SIZE PART NUMBER

A4

0,6 g

SHEET 1/1

PHOTOMETRIC DATA (MEASURED):

CREE

LED XD16
 FWHM 18.0°
 Efficiency 80 %
 Peak intensity 4.8 cd/lm
 LEDs/each optic 1
 Light colour White
 Required components:

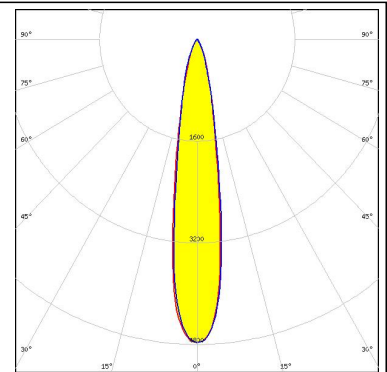

CREE

LED XQ-E HD
 FWHM 16.0°
 Efficiency 86 %
 Peak intensity 6.9 cd/lm
 LEDs/each optic 1
 Light colour White
 Required components:

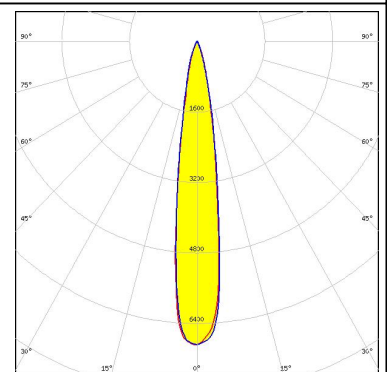
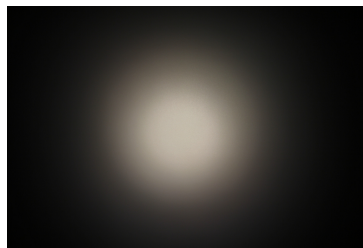

CREE

LED XQ-E HI
 FWHM 11.0°
 Efficiency 80 %
 Peak intensity 10.7 cd/lm
 LEDs/each optic 1
 Light colour White
 Required components:

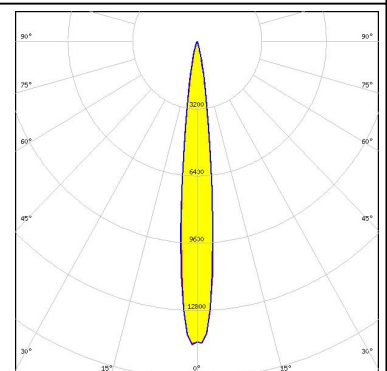

LUMILEDS

LED LUXEON A
 FWHM 26.0°
 Efficiency 89 %
 Peak intensity 3.2 cd/lm
 LEDs/each optic 1
 Light colour White
 Required components:

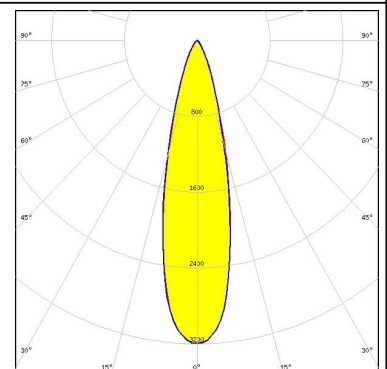
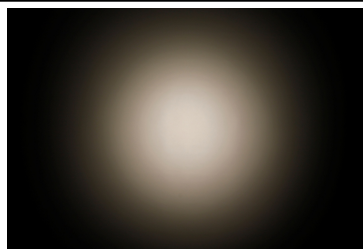

PHOTOMETRIC DATA (MEASURED):

LUMILEDS

LED LUXEON C
 FWHM 17.0°
 Efficiency 86 %
 Peak intensity 6.1 cd/lm
 LEDs/each optic 1
 Light colour White
 Required components:

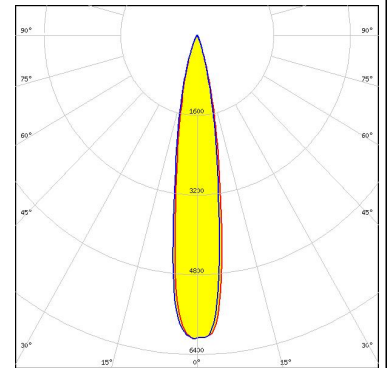

LUMILEDS

LED LUXEON Rebel
 FWHM 20.0°
 Efficiency 90 %
 Peak intensity 4.6 cd/lm
 LEDs/each optic 1
 Light colour White
 Required components:



LUMILEDS

LED LUXEON Rebel ES
 FWHM 24.0°
 Efficiency 88 %
 Peak intensity 3.2 cd/lm
 LEDs/each optic 1
 Light colour White
 Required components:

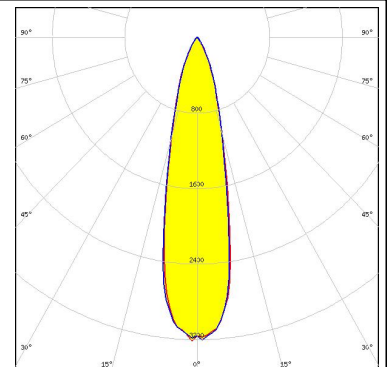



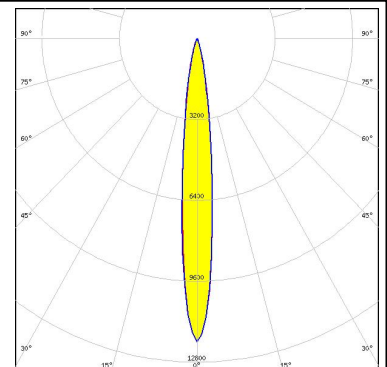

LUMILEDS

LED LUXEON Z
 FWHM 11.0°
 Efficiency 85 %
 Peak intensity 12.1 cd/lm
 LEDs/each optic 1
 Light colour White
 Required components:

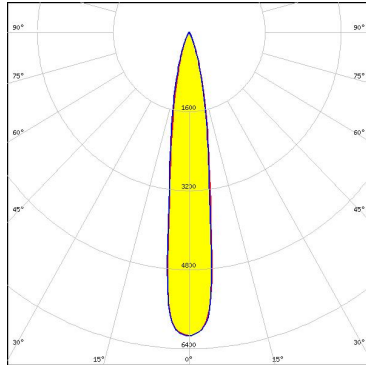
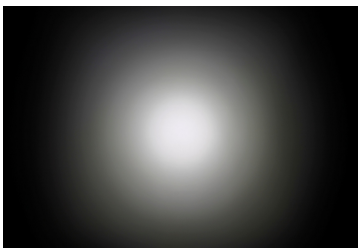
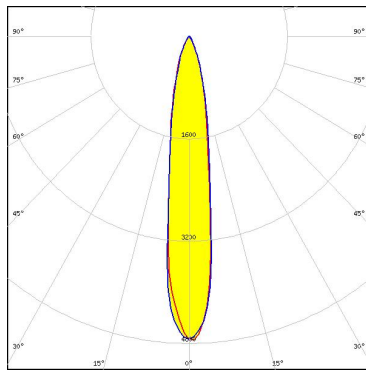

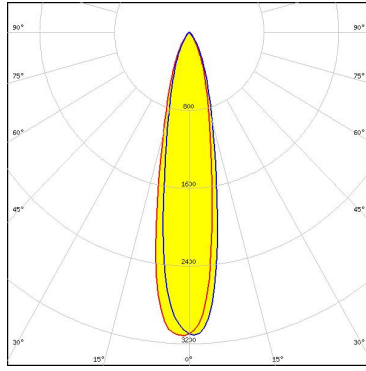
PHOTOMETRIC DATA (MEASURED):

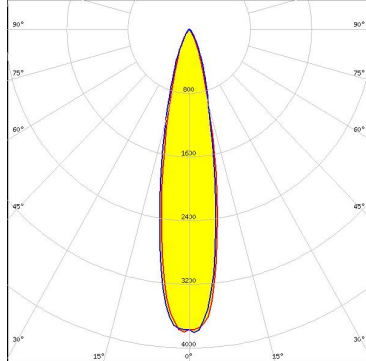
<p>LUMILEDS</p> <p>LED LUXEON Z ES FWHM 16.0° Efficiency 89 % Peak intensity 6.1 cd/lm LEDs/each optic 1 Light colour White Required components:</p>		
<p>NICHIA</p> <p>LED NCSxx19A FWHM 16.0° Efficiency 84 % Peak intensity 4.8 cd/lm LEDs/each optic 1 Light colour White Required components:</p>		
<p>NICHIA</p> <p>LED NVSxx19A FWHM 21.0° Efficiency 81 % Peak intensity 3.1 cd/lm LEDs/each optic 1 Light colour White Required components:</p>		
<p>OSRAM <small>Opto Semiconductors</small></p> <p>LED OSOLON Square EC FWHM 22.0° Efficiency 86 % Peak intensity 3.8 cd/lm LEDs/each optic 1 Light colour White Required components:</p>		

PHOTOMETRIC DATA (MEASURED):

OSRAM
Opto Semiconductors

LED OSLON SSL 150
FWHM 16.0°
Efficiency 87 %
Peak intensity 8.1 cd/lm
LEDs/each optic 1
Light colour White
Required components:



OSRAM
Opto Semiconductors

LED OSLON SSL 80
FWHM 16.0°
Efficiency 83 %
Peak intensity 6.5 cd/lm
LEDs/each optic 1
Light colour White
Required components:

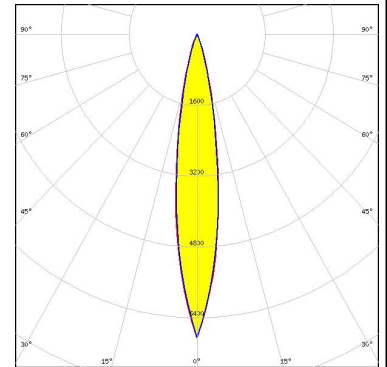
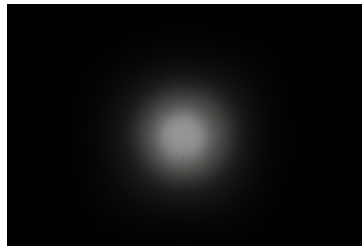

PHOTOMETRIC DATA (SIMULATED):



LED	XP-E
FWHM	15.0°
Efficiency	92 %
LEDs/each optic	1
Light colour	White
Required components:	

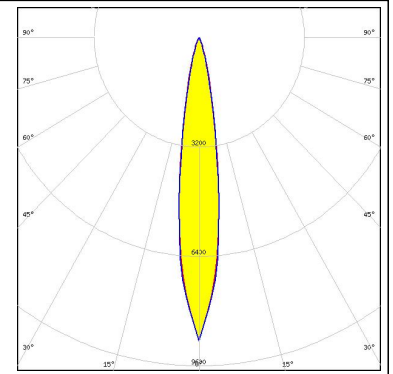

GENERAL INFORMATION:

NOTE: The typical beam angle will be changed by different color, chip size and chip position tolerance. The typical total beam angle is the full angle measured where the luminous intensity is half of the peak value.

MATERIALS:

As part of our continuous research and improvement processes, and to ensure the best possible quality and availability of our products, LEDiL reserves the right to change material grades without notice.

PRODUCT DATA USER AGREEMENT AND DISCLAIMER:

The measured data in the provided downloadable LEDiL Product Datasheets and Mechanical 2D-Drawings is rounded and provided as reference for planning. LEDiL Oy's optical specifications have been verified by conducting performance testing of the products in accordance with the company's quality system. The reported data are averaged results of multiple measurements with typical variation. LEDiL Oy reserves the right to without prior notification make changes and improvements to its products.

LEDiL Oy assumes neither warranty, nor guarantee nor any other liability of any kind for the contents and correctness of the provided data. The provided data has been generated with highest diligence but the provided data may in reality not represent the complete possible variation range of all intrinsic parameters. Therefore, in certain cases a deviation from the provided data could occur.

LEDiL Oy reserves the right to undertake technical changes of its products without further notification which could lead to changes in the provided data. LEDiL Oy assumes no liability of any kind for the possible deviation from any provided data or any other damage resulting from the usage of the provided data.

The user agrees to this disclaimer and user agreement with the download or usage of the provided files.

LEDiL Oy

Joensuunkatu 13
FI-24240 SALO
Finland

LEDiL Inc.

228 West Page Street
Suite D
Sycamore IL 60178
USA

Local sales and technical support

[www.ledil.com/
where_to_buy](http://www.ledil.com/where_to_buy)

Shipping locations

Salo, Finland
Hong Kong, China

Distribution Partners

[www.ledil.com/
where_to_buy](http://www.ledil.com/where_to_buy)

Компания «Life Electronics» занимается поставками электронных компонентов импортного и отечественного производства от производителей и со складов крупных дистрибьюторов Европы, Америки и Азии.

С конца 2013 года компания активно расширяет линейку поставок компонентов по направлению коаксиальный кабель, кварцевые генераторы и конденсаторы (керамические, пленочные, электролитические), за счёт заключения дистрибьюторских договоров

Мы предлагаем:

- Конкуренспособные цены и скидки постоянным клиентам.
- Специальные условия для постоянных клиентов.
- Подбор аналогов.
- Поставку компонентов в любых объемах, удовлетворяющих вашим потребностям.
- Приемлемые сроки поставки, возможна ускоренная поставка.
- Доставку товара в любую точку России и стран СНГ.
- Комплексную поставку.
- Работу по проектам и поставку образцов.
- Формирование склада под заказчика.
- Сертификаты соответствия на поставляемую продукцию (по желанию клиента).
- Тестирование поставляемой продукции.
- Поставку компонентов, требующих военную и космическую приемку.
- Входной контроль качества.
- Наличие сертификата ISO.

В составе нашей компании организован Конструкторский отдел, призванный помогать разработчикам, и инженерам.

Конструкторский отдел помогает осуществить:

- Регистрацию проекта у производителя компонентов.
- Техническую поддержку проекта.
- Защиту от снятия компонента с производства.
- Оценку стоимости проекта по компонентам.
- Изготовление тестовой платы монтаж и пусконаладочные работы.



Тел: +7 (812) 336 43 04 (многоканальный)

Email: org@lifeelectronics.ru