

Power Relay F4

- Pin assignment similar to ISO 7588 part 1
- Plug-in or PCB terminals
- Also available for 42VDC applications

Customized versions on request

- 24VDC versions with contact gap >0.8mm
- Integrated components (e.g. resistor, diode)
- Customized marking/color
- Special covers (e.g. notches, release features, brackets)
- Various contact arrangements and materials
- For latching (bistable) version refer to Power Relay F7 A Latching or Mini Relay Latching
- For shrouded/weatherproof dust cover versions refer to Shrouded Power Relay F4 A and VF4 A



Typical applications

Cross carline up to 40A for example: ABS control, blower fans, car alarm, cooling fan, Electric Power Steering, energy management, engine control, fuel pump, heated front screen, lamps: front, rear, fog light, main switch/supply relay, valves, wiper control.

Contact Data

Contact arrangement	1 form A, 1 NO/1 NO (2x87)		1 form U, 2 NO		1 form C, 1 CO		
Contact gap	>0.8mm						
Rated voltage	12VDC	24VDC	12VDC	24VDC	12VDC	24VDC	24VDC ¹⁾
Limiting continuous current	NO	NO	NO	NO	NO/NC	NO/NC	NO/NC
23°C	60A	60A	2x32A	2x32A	60/45A	60/45A	60/45A
85°C	40A	40A	2x25A	2x25A	40/30A	40/30A	40/30A
125°C	17A	17A	2x11A	2x11A	17/12A	17/12A	17/12A
Limiting making current ²⁾	NO/NC						
NO/NC	120A	120A	2x100A	2x100A	120/45A	120/45A	120/45A
Limiting breaking current	NO/NC						
NO/NC	60A	20A	2x40A	2x15A	60/40A	20/15A	30/20A
Limiting short-time current overload current, ISO 8820-3 ³⁾ :	1.35 x 40A, 1800s 2.00 x 40A, 5s 3.50 x 40A, 0.5s 6.00 x 40A, 0.1s		1.35 x 40A, 1800s 2.00 x 40A, 5s 3.50 x 40A, 0.5s 6.00 x 40A, 0.1s		1.35 x 40A, 1800s 2.00 x 40A, 5s 3.50 x 40A, 0.5s 6.00 x 40A, 0.1s		
Jump start test ISO 16750-1	24VDC for 5min conducting nominal current at 23°C						
Contact material	silver based						
Min. recommended contact load ⁴⁾	1A at 5VDC						
Initial voltage drop	NO contact at 10A, typ./max. 15/200mV NC contact at 10A, typ./max. 20/250mV						
Frequency of operation at nominal load	6 ops./min (0.1Hz)						
Operate/release time typ.	7/2ms ⁵⁾						
Electrical endurance	resistive load at 14VDC >2x10 ⁵ ops. 40A						
resistive load at 28VDC	>1x10 ⁵ ops. 20A		>2x10 ⁵ ops. 2x25A		>2x10 ⁵ ops. 40A (NO)		
			>1x10 ⁵ ops. 2x15A		>1x10 ⁵ ops. 20A (NO)		1x10 ⁵ ops. 30A (NO) >5x10 ⁵ ops. 10A (NC)
Mechanical endurance	DC coil >1x10 ⁷ ops.						

1) Special high performance 24VDC version with contact gap >0.8mm.

2) The values apply to a resistive or inductive load with suitable spark suppression and at maximum 14VDC for 12VDC or 28VDC for 24VDC load voltages. For a load current duration of maximum 3s for a make/break ratio of 1:10.

3) Current and time are compatible with circuit protection by a typical automotive fuse. Relay will make, carry and break the specified current.

4) See chapter Diagnostics of Relays in our Application Notes or consult the internet at <http://relays.te.com/appnotes/>

5) For unsuppressed relay coil. A low resistive suppression device in parallel to the relay coil increases the release time and reduces the lifetime caused by increased erosion and/or higher risk of contact tack welding.

Power Relay F4 (Continued)

Max. load DC breaking capacity

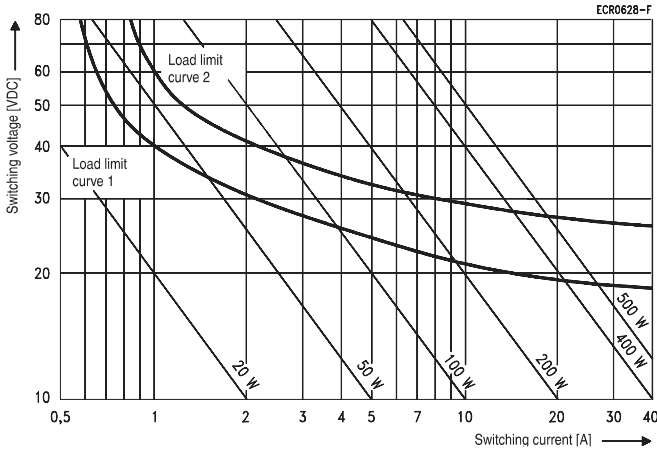

Load limit curve 1: arc extinguishes during transit time (CO contact).
Load limit curve 2: safe shutdown, no stationary arc (NO contact).
Load limit curves measured with low inductive resistors verified for 1000 switching events.

Coil Data

Rated coil voltage	12/24VDC
--------------------	----------

Coil versions, DC coil

Coil code	Rated voltage VDC	Operate voltage VDC	Release voltage VDC	Coil resistance ⁶⁾ Ω±10%	Rated coil power ⁶⁾ W
052	12	7.2	1.6	90	1.6
053	24	14.4	3.2	324	1.8
056	24	16	4	268	2.1

All figures are given for coil without pre-energization, at ambient temperature +23°C.

Coil operating range



Does not take into account the temperature rise due to the contact current E=pre-energization..

6) Without components in parallel.

Insulation Data

Initial dielectric strength	
between open contacts	500V _{rms}
between contact and coil	500V _{rms}
between adjacent contacts	500V _{rms}
Load dump test	
ISO 7637-1 (12VDC), test pulse 5	Vs=+86.5VDC
ISO 7637-2 (24VDC), test pulse 5	Vs=+200VDC

Other Data

EU RoHS/ELV compliance	compliant
Ambient temperature DC coil	-40 to +125°C
Protection to heat and fire	UL94-HB or better ⁷⁾
Climatic cycling with condensation	
EN ISO 6988	6 cycles, storage 8/16h
Temperature cycling	
IEC 60068-2-14, Nb	10 cycles, -40/+85°C (5°C/min)
Damp heat cyclic	
IEC 60068-2-30, Db, Variant 1	6 cycles, upper air temp. 55°C
Damp heat constant	
IEC 60068-2-3, Ca	56 days
Category of environmental protection, IEC 61810	RTI – dustproof, RT III – sealed
Degree of protection, IEC 60529	IP54 (dustproof), IP67 (sealed)
Corrosive gas	
IEC 60068-2-42	10±2cm ³ /m ³ SO ₂ , 10 days
IEC 60068-2-43	1±0.3cm ³ /m ³ H ₂ S, 10 days
Vibration resistance (functional)	
IEC 60068-2-6 (sine sweep)	10 to 500Hz >5g ⁸⁾
Shock resistance (functional)	
IEC 60068-2-27 (half sine)	11ms >20g ⁹⁾
Drop test, free fall	
IEC 60068-2-32	1m onto concrete
Terminal type	plug-in, QC/PCB
Cover retention	
axial force	150N
pull force	150N
push force	150N
Terminal retention	
pull force	100N
push force	100N
resistance to bending, force applied to front ⁹⁾	10N
resistance to bending, force applied to side ⁹⁾	10N
torque	0.3Nm
Weight	approx. 35g (1.2oz)
Packaging unit	
plug-in/PCB	315 pcs.
plug-in with bracket	200 pcs.

7) Refers to used materials.

8) No change in the switching state >10µs. Valid for NC contacts, NO contact values significantly higher.

9) Values apply 2mm from the end of the terminal. When the force is removed, the terminal must not have moved by more than 0.3mm.

Accessories

For details see datasheet Connectors for Mini ISO Relays

Power Relay F4 (Continued)

Terminal Assignment

NO
1 form A, 1 NO

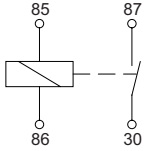

NOR
1 form A, 1 NO
with resistor

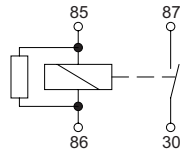

NOR_SD
1 form A, 1 NO
with resistor & serial diode

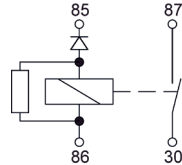

NOR_2x87
1 form A, 1 NO (2x87)

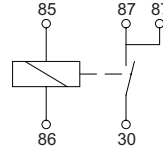

NOR_2x87
1 form A, 1 NO (2x87)
with resistor

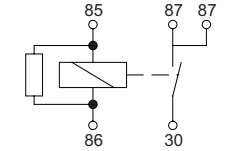

CO
1 form C, 1 CO

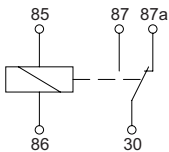

COR
1 form C, 1 CO
with resistor

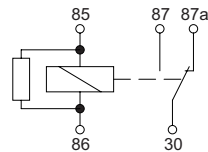

COD
1 form C, 1 CO
with diode

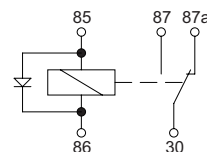

DNO
1 form U, 2 NO

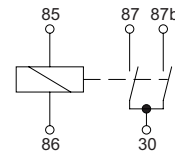

Dimensions

Power Relay F4 with quick connect (QC) terminals

View of the terminals (bottom view)

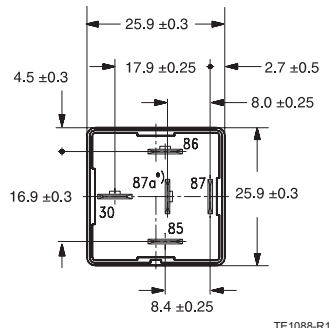

TE1088-R1

For the make contact (2x87), pin 87a = 87;
for the double make contact, pin 87a = 87b.

Quick connect terminal similar to ISO 8092-1

TE1093-S1

Power Relay F4 with PCB terminals

View of the terminals (bottom view)

Mounting hole layout (bottom view)

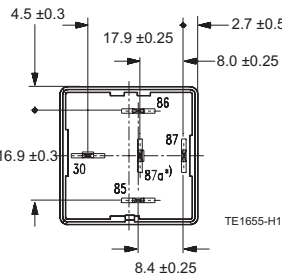
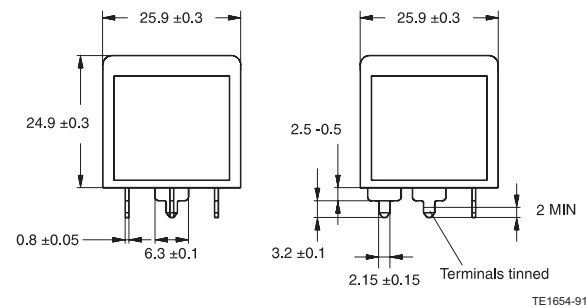

TE1655-H1

For the make contact (2x87), pin 87a = 87;
for the double make contact, pin 87a = 87b.

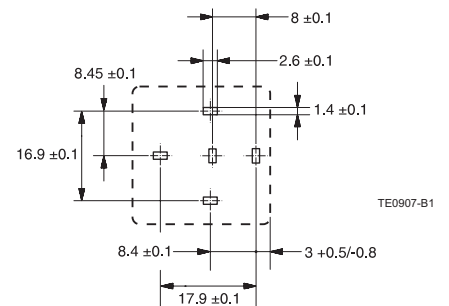

TE0907-B1

TE1654-91

Power Relay F4 (Continued)

Product code structure		Typical product code		V23134	-A	0	052	-C642
Type								
V23134 Power Relay F4								
Contact arrangement								
A	1 form C, 1 CO		C	1 form A, 1 NO (2x87)				
B	1 form A, 1 NO		K	1 form A, 1 NO (non ISO)				
M	1 form U, 2 NO							
Cover								
0	Standard		1	Bracket at terminal 30 ISO				
2	Bracket at terminal 86 ISO							
Coil								
052	12VDC		053	24VDC				
056	24VDC (contact gap >0.8mm)							
Terminal/arrangement								
C642	Plug-in/NO		C643	Plug-in/CO				
G242	PCB/NO		G243	PCB/CO				
Xnnn	Customized (nnn: version number)							

Production in Europe (only)

Product code	Arrangement	Version	Coil suppr.	Circuit ¹⁾	Coil	Contact mat.	Terminals	Part number
V23134-A0052-C643	1 form C, 1 CO	Standard		CO	12VDC	Silver based	Plug-in, QC	2-1393302-2
V23134-A0052-G243							PCB	2-1393302-3
V23134-A0052-X278			R 560Ω	COR			Plug-in, QC	4-1393302-1
V23134-A0053-C643				CO	24VDC			5-1393302-1
V23134-A0053-G243							PCB	5-1393302-2
V23134-A0056-X432 ²⁾			D (cathode 86)	COD			Plug-in, QC	1-1414167-0
V23134-A0056-X433 ²⁾			R 1200Ω	COR				1-1414168-0
V23134-A1052-C643		Bracket		CO	12VDC			5-1393302-8
V23134-A1052-X294 ⁴⁾			R 560Ω	COR				6-1393302-0
V23134-A1053-C643				CO	24VDC			6-1393302-3
V23134-A1053-X295 ⁴⁾			R 1200Ω	COR				6-1393302-4
V23134-B0052-C642	1 form A, 1 NO	Standard		NO	12VDC			7-1393302-5
V23134-B0052-G242							PCB	7-1393302-7
V23134-B0052-X270 ⁶⁾			R 680Ω	NOR			Plug-in, QC	1-1414099-0
V23134-B0052-X506			R 560Ω	NOR_SD ³⁾				4-1414992-3
V23134-B0053-C642				NO	24VDC			1393303-9
V23134-B0053-G242							PCB	1-1393303-0
V23134-B1052-C642		Bracket			12VDC		Plug-in, QC	3-1393303-4
V23134-B1053-C642					24VDC			3-1393303-7
V23134-B1053-X296 ⁴⁾			R 1200Ω	NOR				3-1393303-8
V23134-C0052-C642	1 form A, 1 NO (2x87)	Standard		NO_2x87	12VDC			3-1393303-9
V23134-C0053-C642					24VDC			4-1393303-4
V23134-C1052-C642		Bracket			12VDC			4-1393303-7
V23134-C1052-X280 ⁴⁾⁵⁾			R 560Ω	NOR_2x87				4-1393303-8
V23134-C1053-C642				NO_2x87	24VDC			5-1393303-0
V23134-K1052-X399	1 form A, 1 NO		R 560Ω	NOR non ISO	12VDC		Plug-in, QC/non ISO	1-1393305-1
V23134-M0052-C642	1 form U, 2 NO	Standard		DNO			Plug-in, QC	5-1393304-6
V23134-M0052-G242							PCB	5-1393304-7
V23134-M0053-C642					24VDC		Plug-in, QC	6-1393304-7
V23134-M0053-G242							PCB	6-1393304-8
V23134-M1052-C642		Bracket			12VDC		Plug-in, QC	7-1393304-1
V23134-M1053-C642					24VDC			7-1393304-4

- 1) See terminal assignment diagrams. 2) Special feature: contact gap >0.8mm. 3) Serial diode. 4) No hole in terminal 30. 5) No hole in terminal 87a. 6) No holes in all terminals.

Other types on request.

This list represents the most common types and does not show all variants covered by this datasheet.

Production in Asia (only)

Product code	Arrangement	Version	Coil suppr.	Circuit ¹⁾	Coil	Contact mat.	Terminals	Part number
V23134-B0052-C642	1 form A, 1 NO	Standard		NO	12VDC	Silver based	Plug-in, QC	7-1904094-0
V23134-B0052-X270 ²⁾			R 680Ω	NOR				7-1904094-1
V23134-B0053-C642				NO	24VDC			7-1904094-5

- 1) See terminal assignment diagrams.

- 2) No holes in all terminals.

Other types on request.

This list represents the most common types and does not show all variants covered by this datasheet.

Компания «Life Electronics» занимается поставками электронных компонентов импортного и отечественного производства от производителей и со складов крупных дистрибьюторов Европы, Америки и Азии.

С конца 2013 года компания активно расширяет линейку поставок компонентов по направлению коаксиальный кабель, кварцевые генераторы и конденсаторы (керамические, пленочные, электролитические), за счёт заключения дистрибьюторских договоров

Мы предлагаем:

- Конкурентоспособные цены и скидки постоянным клиентам.
- Специальные условия для постоянных клиентов.
- Подбор аналогов.
- Поставку компонентов в любых объемах, удовлетворяющих вашим потребностям.
- Приемлемые сроки поставки, возможна ускоренная поставка.
- Доставку товара в любую точку России и стран СНГ.
- Комплексную поставку.
- Работу по проектам и поставку образцов.
- Формирование склада под заказчика.
- Сертификаты соответствия на поставляемую продукцию (по желанию клиента).
- Тестирование поставляемой продукции.
- Поставку компонентов, требующих военную и космическую приемку.
- Входной контроль качества.
- Наличие сертификата ISO.

В составе нашей компании организован Конструкторский отдел, призванный помогать разработчикам, и инженерам.

Конструкторский отдел помогает осуществить:

- Регистрацию проекта у производителя компонентов.
- Техническую поддержку проекта.
- Защиту от снятия компонента с производства.
- Оценку стоимости проекта по компонентам.
- Изготовление тестовой платы монтаж и пусконаладочные работы.



Тел: +7 (812) 336 43 04 (многоканальный)
Email: org@lifeelectronics.ru