

MC74LVXU04

Hex Inverter (Unbuffered)

The MC74LVXU04 is an advanced high speed CMOS unbuffered hex inverter. The inputs tolerate voltages up to 7.0 V, allowing the interface of 5.0 V systems to 3.0 V systems.

Features

- High Speed: $t_{PD} = 4.1$ ns (Typ) at $V_{CC} = 3.3$ V
- Low Power Dissipation: $I_{CC} = 2$ μ A (Max) at $T_A = 25^\circ$ C
- Power Down Protection Provided on Inputs
- Balanced Propagation Delays
- Low Noise: $V_{OLP} = 0.5$ V (Max)
- Pin and Function Compatible with Other Standard Logic Families
- These Devices are Pb-Free and are RoHS Compliant



ON Semiconductor[®]

<http://onsemi.com>

MARKING DIAGRAMS

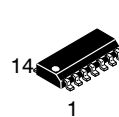

**SOIC-14
D SUFFIX
CASE 751A**

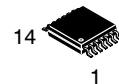
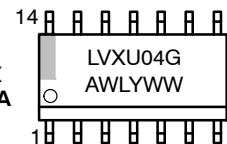

**TSSOP-14
DT SUFFIX
CASE 948G**

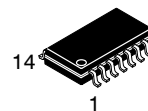
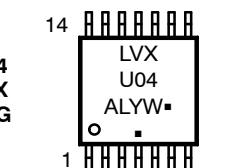

**SOEIAJ-14
M SUFFIX
CASE 965**

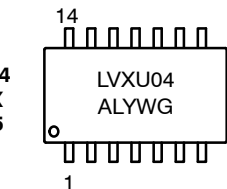

LVXU04 = Specific Device Code
A = Assembly Location
WL, L = Wafer Lot
Y = Year
WW, W = Work Week
G or ■ = Pb-Free Package

(Note: Microdot may be in either location)

ORDERING INFORMATION

See detailed ordering and shipping information in the package dimensions section on page 2 of this data sheet.

MC74LVXU04

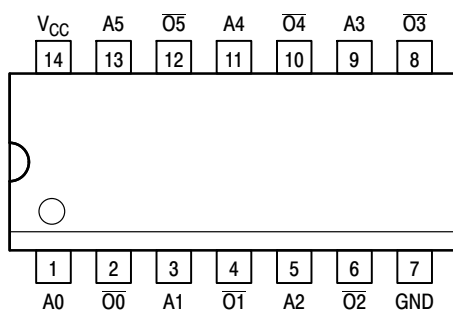

14-Lead Pinout (Top View)

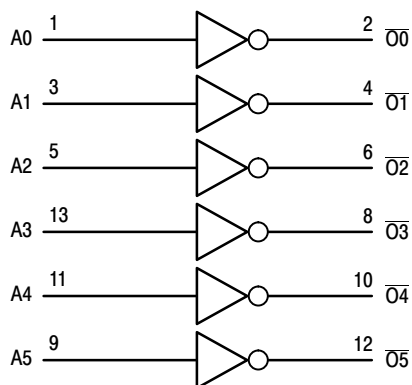

Figure 1. Logic Diagram

PIN NAMES

Pins	Function
A _n	Data Inputs
\overline{O}_n	Outputs

FUNCTION TABLE

A _n	\overline{O}_n
L	H
H	L

ORDERING INFORMATION

Device	Package	Shipping [†]
MC74LVXU04DG	SOIC-14 (Pb-Free)	55 Units / Rail
MC74LVXU04DR2G	SOIC-14 (Pb-Free)	2500 Tape & Reel
MC74LVXU04DTG	TSSOP-14*	96 Units / Rail
MC74LVXU04DTR2G	TSSOP-14*	2500 Tape & Reel
MC74LVXU04MG	SOEIAJ-14 (Pb-Free)	50 Units / Rail

[†]For information on tape and reel specifications, including part orientation and tape sizes, please refer to our Tape and Reel Packaging Specifications Brochure, BRD8011/D.

*This package is inherently Pb-Free.

MC74LVXU04

MAXIMUM RATINGS

Symbol	Parameter	Value	Unit
V _{CC}	DC Supply Voltage	-0.5 to +7.0	V
V _{IN}	DC Input Voltage	-0.5 to +7.0	V
V _{OUT}	DC Output Voltage	-0.5 to V _{CC} + 0.5	V
I _{IK}	DC Input Diode Current V _I < GND	-20	mA
I _{OK}	DC Output Diode Current V _O < GND	±20	mA
I _{OUT}	DC Output Sink Current	±25	mA
I _{CC}	DC Supply Current per Supply Pin	±50	mA
T _{STG}	Storage Temperature Range	-65 to +150	°C
T _L	Lead Temperature, 1 mm from Case for 10 Seconds	260	°C
T _J	Junction Temperature under Bias	+150	°C
θ _{JA}	Thermal Resistance SOIC TSSOP	250	°C/W
P _D	Power Dissipation in Still Air at 85°C SOIC TSSOP	250	mW
MSL	Moisture Sensitivity	Level 1	
F _R	Flammability Rating Oxygen Index: 30% - 35%	UL 94-V0 @ 0.125 in	
V _{ESD}	ESD Withstand Voltage Human Body Model (Note 1) Machine Model (Note 2) Charged Device Model (Note 3)	> 2000 > 200 2000	V
I _{Latchup}	Latchup Performance Above V _{CC} and Below GND at 85°C (Note 4)	±300	mA

Maximum ratings are those values beyond which device damage can occur. Maximum ratings applied to the device are individual stress limit values (not normal operating conditions) and are not valid simultaneously. If these limits are exceeded, device functional operation is not implied, damage may occur and reliability may be affected.

1. Tested to EIA/JESD22-A114-A.
2. Tested to EIA/JESD22-A115-A.
3. Tested to JESD22-C101-A.
4. Tested to EIA/JESD78.

RECOMMENDED OPERATING CONDITIONS

Symbol	Parameter	Min	Max	Unit
V _{CC}	Supply Voltage	2.0	3.6	V
V _I	Input Voltage (Note 5)	0	5.5	V
V _O	Output Voltage (HIGH or LOW State)	0	V _{CC}	V
T _A	Operating Free-Air Temperature	-40	+85	°C
Δt/ΔV	Input Transition Rise or Fall Rate V _{CC} = 3.0 V ± 0.3 V	0	100	ns/V

5. Unused inputs may not be left open. All inputs must be tied to a high- or low-logic input voltage level.

MC74LVXU04

DC ELECTRICAL CHARACTERISTICS

Symbol	Parameter	Test Conditions	V _{CC} V	T _A = 25°C			T _A = -40 to 85°C		Unit
				Min	Typ	Max	Min	Max	
V _{IH}	High-Level Input Voltage		2.0 3.0 3.6	1.5 2.0 2.4			1.5 2.0 2.4		V
V _{IL}	Low-Level Input Voltage		2.0 3.0 3.6			0.5 0.8 0.8		0.5 0.8 0.8	V
V _{OH}	High-Level Output Voltage (V _{in} = V _{IH} or V _{IL})	I _{OH} = -50 μA I _{OH} = -50 μA I _{OH} = -4 mA	2.0 3.0 3.0	1.9 2.9 2.58	2.0 3.0		1.9 2.9 2.48		V
V _{OL}	Low-Level Output Voltage (V _{in} = V _{IH} or V _{IL})	I _{OL} = 50 μA I _{OL} = 50 μA I _{OL} = 4 mA	2.0 3.0 3.0		0.0 0.0	0.1 0.1 0.36		0.1 0.1 0.44	V
I _{in}	Input Leakage Current	V _{in} = 5.5 V or GND	3.6			±0.1		±1.0	μA
I _{CC}	Quiescent Supply Current	V _{in} = V _{CC} or GND	3.6			2.0		20.0	μA

AC ELECTRICAL CHARACTERISTICS (Input t_r = t_f = 3.0ns)

Symbol	Parameter	Test Conditions	T _A = 25°C			T _A = -40 to 85°C		Unit
			Min	Typ	Max	Min	Max	
t _{PLH} , t _{PHL}	Propagation Delay, Input to Output	V _{CC} = 2.7V C _L = 15 pF C _L = 50 pF V _{CC} = 3.3 ± 0.3V C _L = 15 pF C _L = 50 pF		5.4 7.9	10.1 13.6	1.0 1.0	12.5 16.0	ns
t _{OSHL} t _{OSLH}	Output-to-Output Skew (Note 6)	V _{CC} = 2.7V C _L = 50 pF V _{CC} = 3.3 ± 0.3V C _L = 50 pF			1.5 1.5		1.5 1.5	ns

6. Skew is defined as the absolute value of the difference between the actual propagation delay for any two separate outputs of the same device. The specification applies to any outputs switching in the same direction, either HIGH-to-LOW (t_{OSHL}) or LOW-to-HIGH (t_{OSLH}); parameter guaranteed by design.

CAPACITIVE CHARACTERISTICS

Symbol	Parameter	T _A = 25°C			T _A = -40 to 85°C		Unit
		Min	Typ	Max	Min	Max	
C _{in}	Input Capacitance		4	10		10	pF
C _{PD}	Power Dissipation Capacitance (Note 7)		18				pF

7. C_{PD} is defined as the value of the internal equivalent capacitance which is calculated from the operating current consumption without load. Average operating current can be obtained by the equation: I_{CC(OPR)} = C_{PD} • V_{CC} • f_{in} + I_{CC}/6 (per buffer). C_{PD} is used to determine the no-load dynamic power consumption; P_D = C_{PD} • V_{CC}² • f_{in} + I_{CC} • V_{CC}.

NOISE CHARACTERISTICS (Input t_r = t_f = 3.0 ns, C_L = 50 pF, V_{CC} = 3.3 V, Measured in SOIC Package)

Symbol	Characteristic	T _A = 25°C		Unit
		Typ	Max	
V _{OLP}	Quiet Output Maximum Dynamic V _{OL}	0.3	0.5	V
V _{OLV}	Quiet Output Minimum Dynamic V _{OL}	-0.3	-0.5	V
V _{IHD}	Minimum High Level Dynamic Input Voltage		2.0	V
V _{ILD}	Maximum Low Level Dynamic Input Voltage		0.8	V

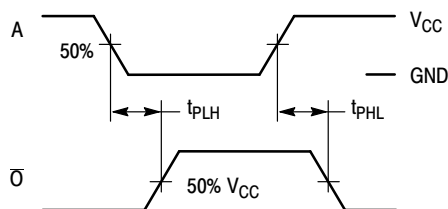
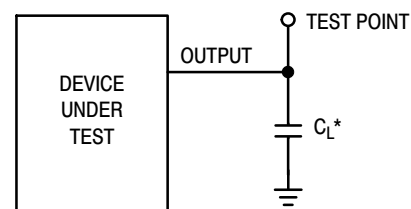

Figure 2. Switching Waveforms



*Includes all probe and jig capacitance

Figure 3. Test Circuit

MC74LVXU04

PACKAGE DIMENSIONS

SOIC-14
D SUFFIX
CASE 751A-03
ISSUE J

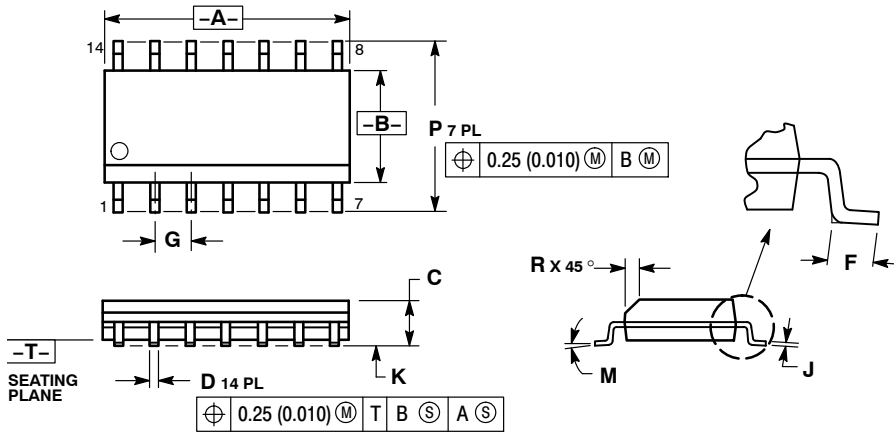

NOTES:

1. DIMENSIONING AND TOLERANCING PER ANSI Y14.5M, 1982.
2. CONTROLLING DIMENSION: MILLIMETER.
3. DIMENSIONS A AND B DO NOT INCLUDE MOLD PROTRUSION.
4. MAXIMUM MOLD PROTRUSION 0.15 (0.006) PER SIDE.
5. DIMENSION D DOES NOT INCLUDE DAMBAR PROTRUSION. ALLOWABLE DAMBAR PROTRUSION SHALL BE 0.127 (0.005) TOTAL IN EXCESS OF THE D DIMENSION AT MAXIMUM MATERIAL CONDITION.

DIM	MILLIMETERS		INCHES	
	MIN	MAX	MIN	MAX
A	8.55	8.75	0.337	0.344
B	3.80	4.00	0.150	0.157
C	1.35	1.75	0.054	0.068
D	0.35	0.49	0.014	0.019
F	0.40	1.25	0.016	0.049
G	1.27 BSC		0.050 BSC	
J	0.19	0.25	0.008	0.009
K	0.10	0.25	0.004	0.009
M	0°	7°	0°	7°
P	5.80	6.20	0.228	0.244
R	0.25	0.50	0.010	0.019

SOLDERING FOOTPRINT

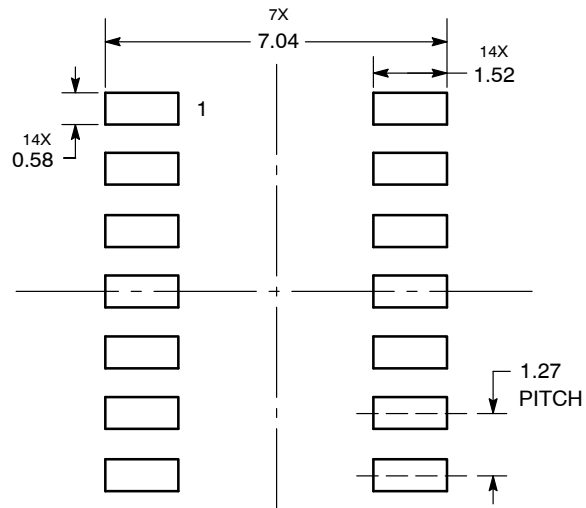

DIMENSIONS: MILLIMETERS

MC74LVXU04

PACKAGE DIMENSIONS

TSSOP-14
DT SUFFIX
CASE 948G-01
ISSUE B

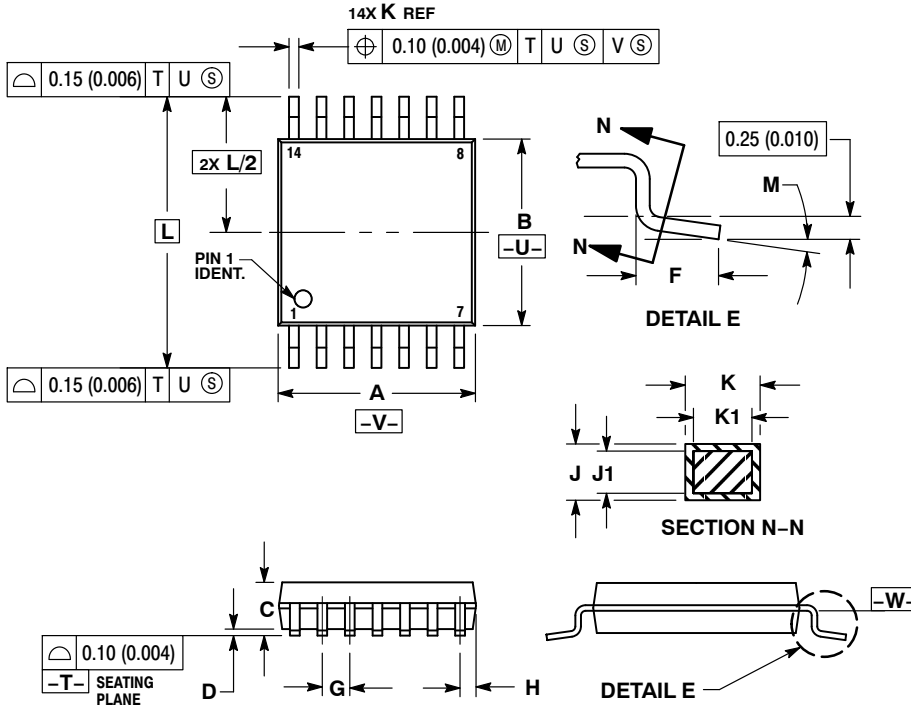

NOTES:

1. DIMENSIONING AND TOLERANCING PER ANSI Y14.5M, 1982.
2. CONTROLLING DIMENSION: MILLIMETER.
3. DIMENSION A DOES NOT INCLUDE MOLD FLASH, PROTRUSIONS OR GATE BURRS. MOLD FLASH OR GATE BURRS SHALL NOT EXCEED 0.15 (0.006) PER SIDE.
4. DIMENSION B DOES NOT INCLUDE INTERLEAD FLASH OR PROTRUSION. INTERLEAD FLASH OR PROTRUSION SHALL NOT EXCEED 0.25 (0.010) PER SIDE.
5. DIMENSION K DOES NOT INCLUDE DAMBAR PROTRUSION. ALLOWABLE DAMBAR PROTRUSION SHALL BE 0.08 (0.003) TOTAL IN EXCESS OF THE K DIMENSION AT MAXIMUM MATERIAL CONDITION.
6. TERMINAL NUMBERS ARE SHOWN FOR REFERENCE ONLY.
7. DIMENSION A AND B ARE TO BE DETERMINED AT DATUM PLANE -W-.

SOLDERING FOOTPRINT

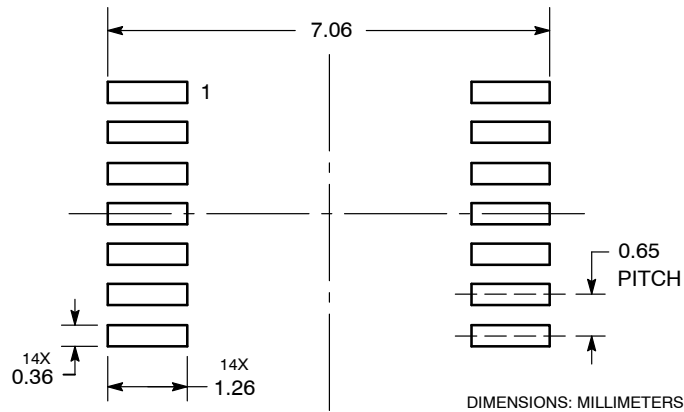

MC74LVXU04

PACKAGE DIMENSIONS

SOEIAJ-14
M SUFFIX
CASE 965-01
ISSUE B

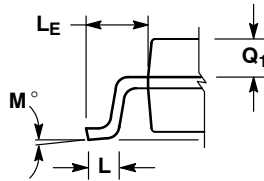
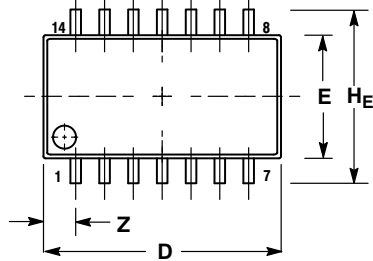

DETAIL P

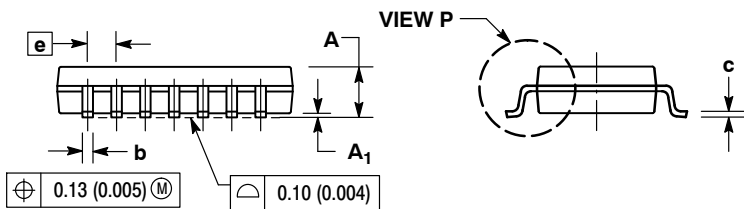

NOTES:

1. DIMENSIONING AND TOLERANCING PER ANSI Y14.5M, 1982.
2. CONTROLLING DIMENSION: MILLIMETER.
3. DIMENSIONS D AND E DO NOT INCLUDE MOLD FLASH OR PROTRUSIONS AND ARE MEASURED AT THE PARTING LINE. MOLD FLASH OR PROTRUSIONS SHALL NOT EXCEED 0.15 (0.006) PER SIDE.
4. TERMINAL NUMBERS ARE SHOWN FOR REFERENCE ONLY.
5. THE LEAD WIDTH DIMENSION (b) DOES NOT INCLUDE DAMBAR PROTRUSION. ALLOWABLE DAMBAR PROTRUSION SHALL BE 0.08 (0.003) TOTAL IN EXCESS OF THE LEAD WIDTH DIMENSION AT MAXIMUM MATERIAL CONDITION. DAMBAR CANNOT BE LOCATED ON THE LOWER RADIUS OR THE FOOT. MINIMUM SPACE BETWEEN PROTRUSIONS AND ADJACENT LEAD TO BE 0.46 (0.018).

DIM	MILLIMETERS		INCHES	
	MIN	MAX	MIN	MAX
A	---	2.05	---	0.081
A ₁	0.05	0.20	0.002	0.008
b	0.35	0.50	0.014	0.020
c	0.10	0.20	0.004	0.008
D	9.90	10.50	0.390	0.413
E	5.10	5.45	0.201	0.215
e	1.27 BSC 0.050 BSC			
H _E	7.40	8.20	0.291	0.323
L	0.50	0.85	0.020	0.033
L _E	1.10	1.50	0.043	0.059
M	0°	10°	0°	10°
Q ₁	0.70	0.90	0.028	0.035
Z	---	1.42	---	0.056

ON Semiconductor and are registered trademarks of Semiconductor Components Industries, LLC (SCILLC). SCILLC reserves the right to make changes without further notice to any products herein. SCILLC makes no warranty, representation or guarantee regarding the suitability of its products for any particular purpose, nor does SCILLC assume any liability arising out of the application or use of any product or circuit, and specifically disclaims any and all liability, including without limitation special, consequential or incidental damages. "Typical" parameters which may be provided in SCILLC data sheets and/or specifications can and do vary in different applications and actual performance may vary over time. All operating parameters, including "Typicals" must be validated for each customer application by customer's technical experts. SCILLC does not convey any license under its patent rights nor the rights of others. SCILLC products are not designed, intended, or authorized for use as components in systems intended for surgical implant into the body, or other applications intended to support or sustain life, or for any other application in which the failure of the SCILLC product could create a situation where personal injury or death may occur. Should Buyer purchase or use SCILLC products for any such unintended or unauthorized application, Buyer shall indemnify and hold SCILLC and its officers, employees, subsidiaries, affiliates, and distributors harmless against all claims, costs, damages, and expenses, and reasonable attorney fees arising out of, directly or indirectly, any claim of personal injury or death associated with such unintended or unauthorized use, even if such claim alleges that SCILLC was negligent regarding the design or manufacture of the part. SCILLC is an Equal Opportunity/Affirmative Action Employer. This literature is subject to all applicable copyright laws and is not for resale in any manner.

PUBLICATION ORDERING INFORMATION

LITERATURE FULFILLMENT:
Literature Distribution Center for ON Semiconductor
P.O. Box 5163, Denver, Colorado 80217 USA
Phone: 303-675-2175 or 800-344-3860 Toll Free USA/Canada
Fax: 303-675-2176 or 800-344-3867 Toll Free USA/Canada
Email: orderlit@onsemi.com

N. American Technical Support: 800-282-9855 Toll Free
USA/Canada
Europe, Middle East and Africa Technical Support:
Phone: 421 33 790 2910
Japan Customer Focus Center
Phone: 81-3-5773-3850

ON Semiconductor Website: www.onsemi.com

Order Literature: <http://www.onsemi.com/orderlit>

For additional information, please contact your local Sales Representative

Компания «Life Electronics» занимается поставками электронных компонентов импортного и отечественного производства от производителей и со складов крупных дистрибьюторов Европы, Америки и Азии.

С конца 2013 года компания активно расширяет линейку поставок компонентов по направлению коаксиальный кабель, кварцевые генераторы и конденсаторы (керамические, пленочные, электролитические), за счёт заключения дистрибьюторских договоров

Мы предлагаем:

- Конкурентоспособные цены и скидки постоянным клиентам.
- Специальные условия для постоянных клиентов.
- Подбор аналогов.
- Поставку компонентов в любых объемах, удовлетворяющих вашим потребностям.
- Приемлемые сроки поставки, возможна ускоренная поставка.
- Доставку товара в любую точку России и стран СНГ.
- Комплексную поставку.
- Работу по проектам и поставку образцов.
- Формирование склада под заказчика.
- Сертификаты соответствия на поставляемую продукцию (по желанию клиента).
- Тестирование поставляемой продукции.
- Поставку компонентов, требующих военную и космическую приемку.
- Входной контроль качества.
- Наличие сертификата ISO.

В составе нашей компании организован Конструкторский отдел, призванный помогать разработчикам, и инженерам.

Конструкторский отдел помогает осуществить:

- Регистрацию проекта у производителя компонентов.
- Техническую поддержку проекта.
- Защиту от снятия компонента с производства.
- Оценку стоимости проекта по компонентам.
- Изготовление тестовой платы монтаж и пусконаладочные работы.



Тел: +7 (812) 336 43 04 (многоканальный)

Email: org@lifeelectronics.ru