

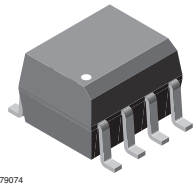

Optocoupler, Phototransistor Output, with Base Connection in SOIC-8 Package

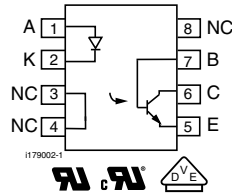

1179074



DESCRIPTION

The VO205AT, VO206AT, VO207AT, VO208AT are optically coupled pairs with a gallium arsenide infrared LED and a silicon NPN phototransistor. Signal information, including a DC level, can be transmitted by the device while maintaining a high degree of electrical isolation between input and output. This family comes in a standard SOIC-8A small outline package for surface mounting which makes them ideally suited for high density application with limited space.

FEATURES

- High BV_CEO, 70 V
• Isolation test voltage, 4000 V_RMS
• Material categorization: For definitions of compliance please see www.vishay.com/doc?99912



RoHS COMPLIANT

AGENCY APPROVALS

- UL1577, file no. E52744 system code Y
• cUL - file no. E52744, equivalent to CSA bulletin 5A
• DIN EN 60747-5-5 (VDE 0884-5) approved, contact customer service if this option is required

ORDERING INFORMATION

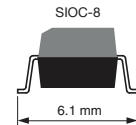
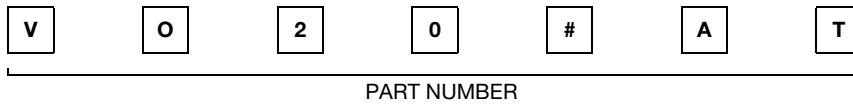

Table with columns: AGENCY CERTIFIED/PACKAGE, CTR (%), and sub-columns for CTR ranges (40 to 80, 63 to 125, 100 to 200, 160 to 320) and corresponding part numbers (VO205AT, VO206AT, VO207AT, VO208AT).

ABSOLUTE MAXIMUM RATINGS (T_amb = 25 °C, unless otherwise specified)

Table with columns: PARAMETER, TEST CONDITION, SYMBOL, VALUE, UNIT. Rows include INPUT (Peak reverse voltage, Forward continuous current, Peak forward current, Power dissipation, Derate linearly from 25 °C), OUTPUT (Collector emitter breakdown voltage, Emitter collector breakdown voltage, Collector-base breakdown voltage, I_Cmax, DC, I_Cmax, Power dissipation, Derate linearly from 25 °C), and COUPLER (Isolation test voltage, Total package dissipation, Derate linearly from 25 °C, Operating temperature, Storage temperature, Soldering time).

Note

- Stresses in excess of the absolute maximum ratings can cause permanent damage to the device. Functional operation of the device is not implied at these or any other conditions in excess of those given in the operational sections of this document. Exposure to absolute maximum ratings for extended periods of the time can adversely affect reliability.

ELECTRICAL CHARACTERISTICS ($T_{amb} = 25\text{ }^{\circ}\text{C}$, unless otherwise specified)

PARAMETER	TEST CONDITION	PART	SYMBOL	MIN.	TYP.	MAX.	UNIT
INPUT							
Forward voltage	$I_F = 10\text{ mA}$		V_F		1.3	1.5	V
Reverse current	$V_R = 6\text{ V}$		I_R		0.1	100	μA
Capacitance	$V_R = 0\text{ V}$		C_O		13		pF
OUTPUT							
Collector emitter breakdown voltage	$I_C = 100\text{ }\mu\text{A}$		BV_{CEO}	70			V
Emitter collector breakdown voltage	$I_E = 10\text{ }\mu\text{A}$		BV_{ECO}	7	10		V
Collector base breakdown voltage	$I_C = 100\text{ }\mu\text{A}$		BV_{CBO}	100			V
Collector base current			I_{CBO}			1	nA
Emitter base current			I_{EBO}			1	nA
Collector emitter leakage current	$V_{CE} = 10\text{ V}$		I_{CEO}		5	50	nA
Saturation voltage, collector emitter	$I_C = 2\text{ mA}, I_F = 10\text{ mA}$		V_{CEsat}			0.4	V
COUPLER							
Capacitance, input to output			C_{IO}		0.5		pF

Note

- Minimum and maximum values were tested requirements. Typical values are characteristics of the device and are the result of engineering evaluations. Typical values are for information only and are not part of the testing requirements.

CURRENT TRANSFER RATIO

PARAMETER	TEST CONDITION	PART	SYMBOL	MIN.	TYP.	MAX.	UNIT
I_C/I_F	$I_F = 10\text{ mA}, V_{CE} = 5\text{ V}$	VO205AT	CTR	40		80	%
		VO206AT	CTR	63		125	%
		VO207AT	CTR	100		200	%
		VO208AT	CTR	160		320	%

SWITCHING CHARACTERISTICS

PARAMETER	TEST CONDITION	PART	SYMBOL	MIN.	TYP.	MAX.	UNIT
Turn-on time	$I_C = 2\text{ mA}, R_L = 100\text{ }\Omega, V_{CC} = 10\text{ V}$		t_{on}		3		μs
Turn-off time	$I_C = 2\text{ mA}, R_L = 100\text{ }\Omega, V_{CC} = 10\text{ V}$		t_{off}		3		μs
Rise time	$I_C = 2\text{ mA}, R_L = 100\text{ }\Omega, V_{CC} = 10\text{ V}$		t_r		3		μs
Fall time	$I_C = 2\text{ mA}, R_L = 100\text{ }\Omega, V_{CC} = 10\text{ V}$		t_f		2		μs

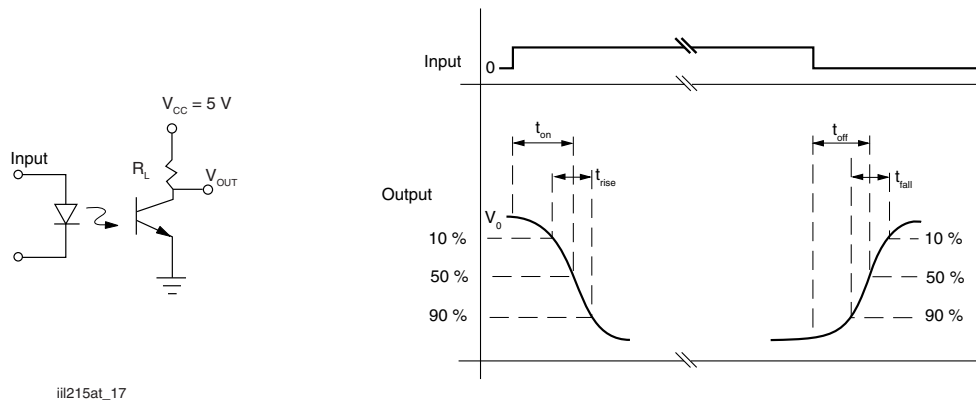

Fig. 1 Switching Test Circuit

COMMON MODE TRANSIENT IMMUNITY

PARAMETER	TEST CONDITION	SYMBOL	MIN.	TYP.	MAX.	UNIT
Common mode transient immunity at logic high	$V_{CM} = 1000\text{ V}_{P-P}$, $R_L = 1\text{ k}\Omega$, $I_F = 0\text{ mA}$	$ C_{MH} $		5000		V/ μs
Common mode transient immunity at logic low	$V_{CM} = 1000\text{ V}_{P-P}$, $R_L = 1\text{ k}\Omega$, $I_F = 10\text{ mA}$	$ C_{ML} $		5000		V/ μs

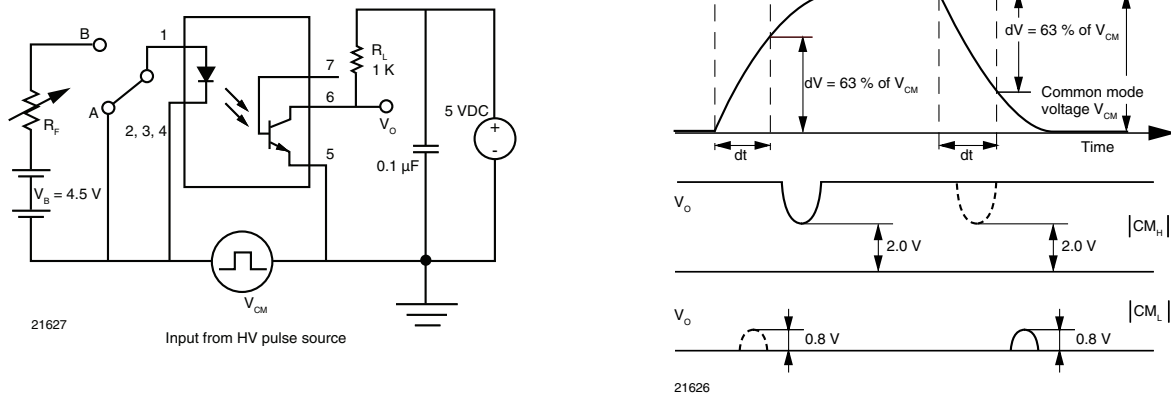

Fig. 1 - Test Circuit for Common Mode Transient Immunity

SAFETY AND INSULATION RATINGS

PARAMETER	TEST CONDITION	SYMBOL	MIN.	TYP.	MAX.	UNIT
Climatic classification (according to IEC 68 part 1)				40/100/21		
Polution degree				2		
Comparative tracking index		CTI	175		399	
Isolation test voltage	1 s	V_{ISO}	4000			V_{RMS}
Peak transient overvoltage		V_{IOTM}	6000			V
Peak insulation voltage		V_{IORM}	560			V
Resistance (input to output)		R_{IO}		100		$G\Omega$
Safety rating - power output		P_{SO}			350	mW
Safety rating - input current		I_{SI}			150	mA
Safety rating - temperature		T_{SI}			165	$^{\circ}\text{C}$
External creepage distance			4			mm
External clearance distance			4			mm
Internal creepage distance			3.3			mm
Insulation thickness			0.2			mm

Note

- As per IEC 60747-5-2, §7.4.3.8.1, this optocoupler is suitable for “safe electrical insulation” only within the safety ratings. Compliance with the safety ratings shall be ensured by means of protective circuits.

TYPICAL CHARACTERISTICS ($T_{amb} = 25\text{ }^{\circ}\text{C}$, unless otherwise specified)

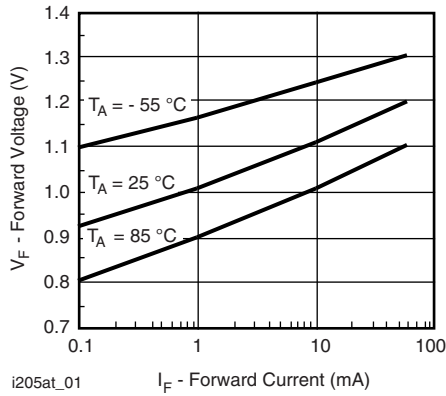

Fig. 2 - Forward Voltage vs. Forward Current

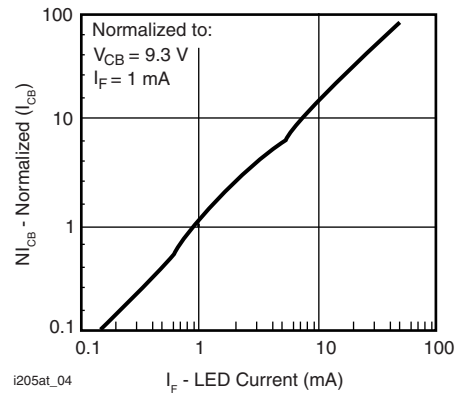

Fig. 5 - Normalized Collector-Base Photocurrent vs. LED Current

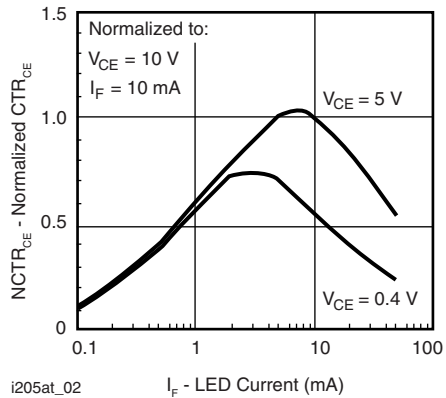

Fig. 3 - Normalized Non-Saturated and Saturated CTR_{CE} vs. LED Current

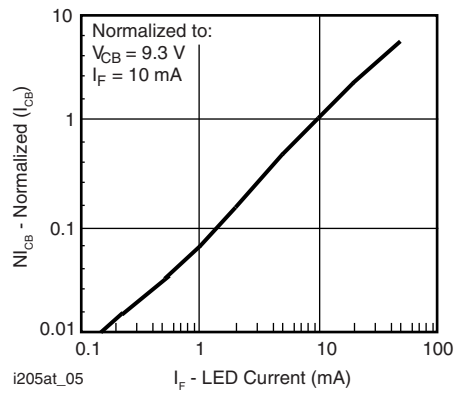

Fig. 6 - Normalized Collector-Base Photocurrent vs. LED Current

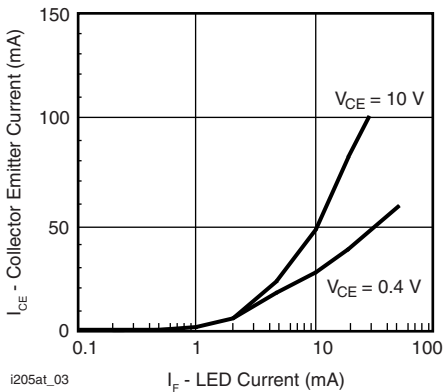

Fig. 4 - Collector Emitter Current vs. LED Current

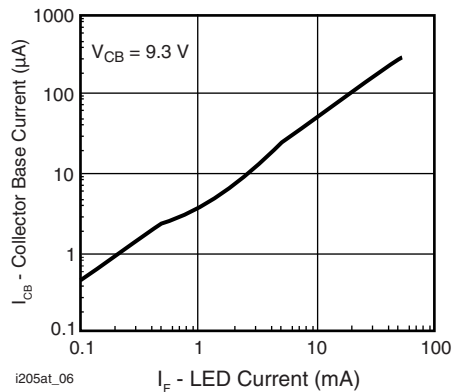
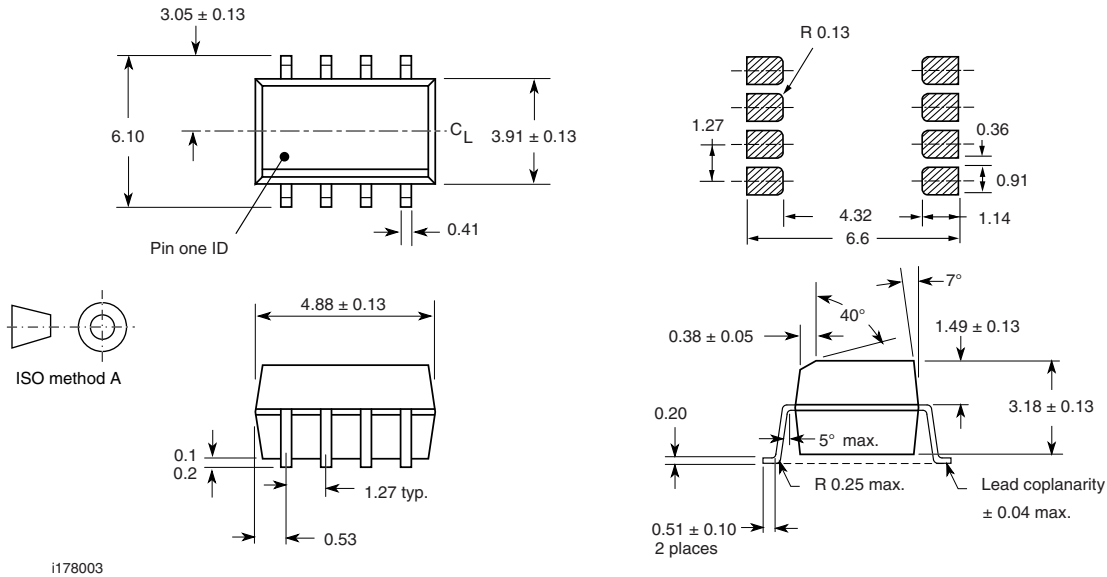
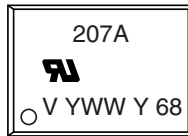

Fig. 7 - Collector Base Photocurrent vs. LED Current

PACKAGE DIMENSIONS in millimeters



PACKAGE MARKING (example of VO207AT)



TAPE AND REEL PACKAGING

Dimensions in millimeters

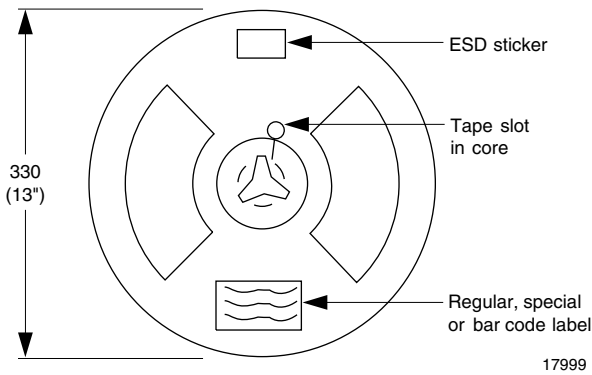

Fig. 8 - Tape and Reel Shipping Medium (EIA-481, revision A, and IEC 60286), 2000 units per reel

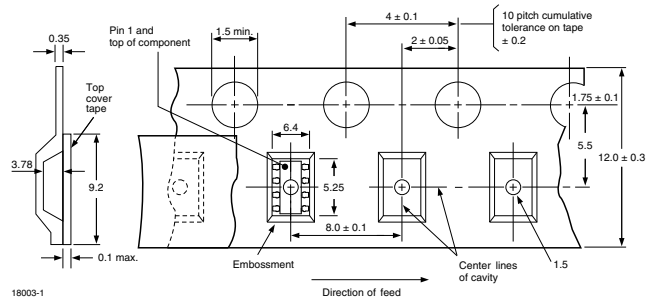

Fig. 9 - Tape Dimensions, 2000 Parts per Reel



Disclaimer

ALL PRODUCT, PRODUCT SPECIFICATIONS AND DATA ARE SUBJECT TO CHANGE WITHOUT NOTICE TO IMPROVE RELIABILITY, FUNCTION OR DESIGN OR OTHERWISE.

Vishay Intertechnology, Inc., its affiliates, agents, and employees, and all persons acting on its or their behalf (collectively, "Vishay"), disclaim any and all liability for any errors, inaccuracies or incompleteness contained in any datasheet or in any other disclosure relating to any product.

Vishay makes no warranty, representation or guarantee regarding the suitability of the products for any particular purpose or the continuing production of any product. To the maximum extent permitted by applicable law, Vishay disclaims (i) any and all liability arising out of the application or use of any product, (ii) any and all liability, including without limitation special, consequential or incidental damages, and (iii) any and all implied warranties, including warranties of fitness for particular purpose, non-infringement and merchantability.

Statements regarding the suitability of products for certain types of applications are based on Vishay's knowledge of typical requirements that are often placed on Vishay products in generic applications. Such statements are not binding statements about the suitability of products for a particular application. It is the customer's responsibility to validate that a particular product with the properties described in the product specification is suitable for use in a particular application. Parameters provided in datasheets and/or specifications may vary in different applications and performance may vary over time. All operating parameters, including typical parameters, must be validated for each customer application by the customer's technical experts. Product specifications do not expand or otherwise modify Vishay's terms and conditions of purchase, including but not limited to the warranty expressed therein.

Except as expressly indicated in writing, Vishay products are not designed for use in medical, life-saving, or life-sustaining applications or for any other application in which the failure of the Vishay product could result in personal injury or death. Customers using or selling Vishay products not expressly indicated for use in such applications do so at their own risk. Please contact authorized Vishay personnel to obtain written terms and conditions regarding products designed for such applications.

No license, express or implied, by estoppel or otherwise, to any intellectual property rights is granted by this document or by any conduct of Vishay. Product names and markings noted herein may be trademarks of their respective owners.

Material Category Policy

Vishay Intertechnology, Inc. hereby certifies that all its products that are identified as RoHS-Compliant fulfill the definitions and restrictions defined under Directive 2011/65/EU of The European Parliament and of the Council of June 8, 2011 on the restriction of the use of certain hazardous substances in electrical and electronic equipment (EEE) - recast, unless otherwise specified as non-compliant.

Please note that some Vishay documentation may still make reference to RoHS Directive 2002/95/EC. We confirm that all the products identified as being compliant to Directive 2002/95/EC conform to Directive 2011/65/EU.

Vishay Intertechnology, Inc. hereby certifies that all its products that are identified as Halogen-Free follow Halogen-Free requirements as per JEDEC JS709A standards. Please note that some Vishay documentation may still make reference to the IEC 61249-2-21 definition. We confirm that all the products identified as being compliant to IEC 61249-2-21 conform to JEDEC JS709A standards.

Компания «Life Electronics» занимается поставками электронных компонентов импортного и отечественного производства от производителей и со складов крупных дистрибьюторов Европы, Америки и Азии.

С конца 2013 года компания активно расширяет линейку поставок компонентов по направлению коаксиальный кабель, кварцевые генераторы и конденсаторы (керамические, пленочные, электролитические), за счёт заключения дистрибьюторских договоров

Мы предлагаем:

- Конкурентоспособные цены и скидки постоянным клиентам.
- Специальные условия для постоянных клиентов.
- Подбор аналогов.
- Поставку компонентов в любых объемах, удовлетворяющих вашим потребностям.
- Приемлемые сроки поставки, возможна ускоренная поставка.
- Доставку товара в любую точку России и стран СНГ.
- Комплексную поставку.
- Работу по проектам и поставку образцов.
- Формирование склада под заказчика.
- Сертификаты соответствия на поставляемую продукцию (по желанию клиента).
- Тестирование поставляемой продукции.
- Поставку компонентов, требующих военную и космическую приемку.
- Входной контроль качества.
- Наличие сертификата ISO.

В составе нашей компании организован Конструкторский отдел, призванный помогать разработчикам, и инженерам.

Конструкторский отдел помогает осуществить:

- Регистрацию проекта у производителя компонентов.
- Техническую поддержку проекта.
- Защиту от снятия компонента с производства.
- Оценку стоимости проекта по компонентам.
- Изготовление тестовой платы монтаж и пусконаладочные работы.



Тел: +7 (812) 336 43 04 (многоканальный)
Email: org@lifeelectronics.ru