



### FEATURES

- 16-channel, dual, simultaneously sampled inputs
- Independently selectable channel input ranges
  - True bipolar:  $\pm 10\text{ V}$ ,  $\pm 5\text{ V}$ ,  $\pm 2.5\text{ V}$
- Single 5 V analog supply and 2.3 V to 3.6 V  $V_{\text{DRIVE}}$  supply
- Fully integrated data acquisition solution
  - Analog input clamp protection
  - Input buffer with 1 M $\Omega$  analog input impedance
  - First-order antialiasing analog filter
  - On-chip accurate reference and reference buffer
  - Dual 14-bit SAR ADC
  - Throughput rate:  $2 \times 1\text{ MSPS}$  per channel pair
  - Oversampling capability with digital filter
  - Flexible sequencer with burst mode
- Flexible parallel/serial interface
  - SPI/QSPI/MICROWIRE/DSP compatible
  - Optional CRC error checking
- Hardware/software configuration
- Performance
  - 85.3 dB typical SNR at 500 kSPS ( $2 \times$  oversampling)
  - 85 dB typical SNR at 1 MSPS
  - 103 dB typical THD at  $\pm 10\text{ V}$  range
  - $\pm 0.3\text{ LSB INL}$  (typical),  $\pm 0.99\text{ LSB DNL}$  (maximum)
  - 8 kV ESD analog input pins only
- On-chip self detect function
- 80-lead LQFP package

### APPLICATIONS

- Power line monitoring
- Protective relays
- Multiphase motor control
- Instrumentation and control systems
- Data acquisition systems (DASs)

### GENERAL DESCRIPTION

The AD7617 is a 14-bit, DAS that supports dual simultaneous sampling of 16 channels. The AD7617 operates from a single +5 V supply and can accommodate  $\pm 10\text{ V}$ ,  $\pm 5\text{ V}$ , and  $\pm 2.5\text{ V}$  true bipolar input signals while sampling at throughput rates up to 1 MSPS per channel pair with 85 dB signal-to-noise ratio (SNR). Higher SNR performance can be achieved with the on-chip oversampling mode (85.3 dB for an oversampling ratio (OSR) of 2).

The input clamp protection circuitry can tolerate voltages up to  $\pm 21\text{ V}$ . The AD7617 has 1 M $\Omega$  analog input impedance, regardless of sampling frequency. The single-supply operation, on-chip filtering, and high input impedance eliminate the need for driver op amps and external bipolar supplies.

The device contains analog input clamp protection, a dual, 14-bit charge redistribution successive approximation register (SAR) analog-to-digital converter (ADC), a flexible digital filter, a 2.5 V reference and reference buffer, and high speed serial and parallel interfaces. The AD7617 is serial peripheral interface (SPI)/QSPI™/DSP/MICROWIRE compatible.

### FUNCTIONAL BLOCK DIAGRAM

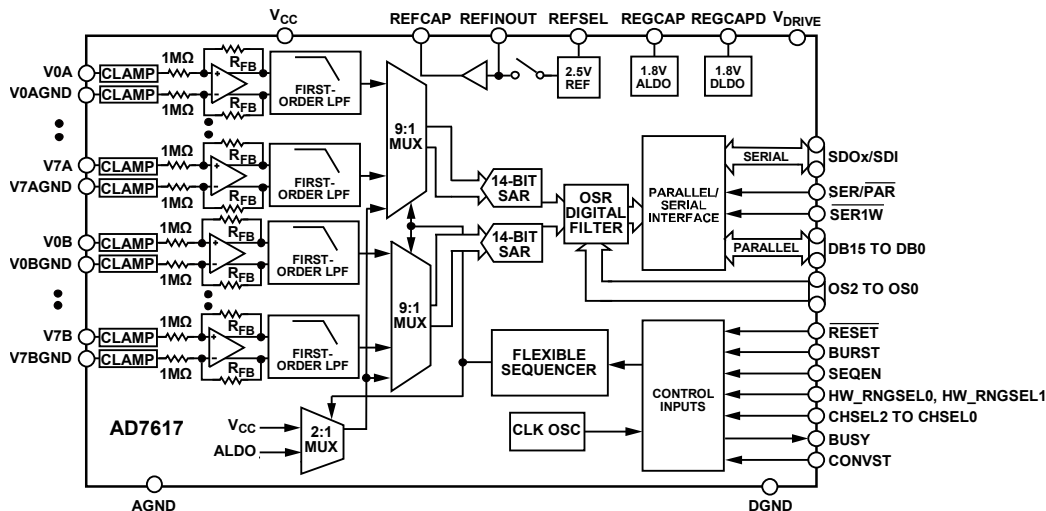

NOTES  
 1. MULTIFUNCTION PINS, SUCH AS DB15/OS2, ARE REFERRED TO BY A SINGLE FUNCTION OF THE PIN, FOR EXAMPLE, DB15, WHEN ONLY THAT FUNCTION IS RELEVANT. REFER TO THE PIN CONFIGURATION AND FUNCTION DESCRIPTIONS SECTION FOR MORE INFORMATION.

Figure 1. AD7617 Functional Block Diagram

18077-001

Rev. 0

### Document Feedback

Information furnished by Analog Devices is believed to be accurate and reliable. However, no responsibility is assumed by Analog Devices for its use, nor for any infringements of patents or other rights of third parties that may result from its use. Specifications subject to change without notice. No license is granted by implication or otherwise under any patent or patent rights of Analog Devices. Trademarks and registered trademarks are the property of their respective owners.

## TABLE OF CONTENTS

Features .....	1	Digital Interface .....	28
Applications .....	1	Hardware Mode .....	28
General Description .....	1	Software Mode .....	29
Functional Block Diagram .....	1	Reset Functionality .....	29
Revision History .....	2	Pin Function Overview .....	30
Specifications .....	3	Digital Interface .....	31
Timing Specifications .....	6	Channel Selection .....	31
Absolute Maximum Ratings .....	10	Parallel Interface .....	32
Thermal Resistance .....	10	Serial Interface .....	33
ESD Caution .....	10	Sequencer .....	36
Pin Configuration and Function Descriptions .....	11	Hardware Mode Sequencer .....	36
Typical Performance Characteristics .....	15	Software Mode Sequencer .....	36
Terminology .....	21	Burst Sequencer .....	37
Theory of Operation .....	23	Diagnostics .....	39
Converter Details .....	23	Diagnostic Channels .....	39
Analog Input .....	23	Interface Self Test .....	39
ADC Transfer Function .....	24	CRC .....	39
Internal/External Reference .....	24	Register Summary .....	41
Shutdown Mode .....	25	Addressing Registers .....	42
Digital Filter .....	25	Configuration Register .....	43
Applications Information .....	26	Channel Register .....	44
Functionality Overview .....	26	Input Range Registers .....	45
Power Supplies .....	26	Sequencer Stack Registers .....	49
Typical Connections .....	26	Status Register .....	50
Device Configuration .....	28	Outline Dimensions .....	51
Operational Mode .....	28	Ordering Guide .....	51
Internal/External Reference .....	28		

## REVISION HISTORY

7/2017—Revision 0: Initial Version

## SPECIFICATIONS

$V_{REF} = 2.5$  V external/internal,  $V_{CC} = 4.75$  V to 5.25 V,  $V_{DRIVE} = 2.3$  V to 3.6 V, sampling frequency ( $f_{SAMPLE}$ ) = 1 MSPS,  $T_A = -40^\circ\text{C}$  to  $+125^\circ\text{C}$ , unless otherwise noted.

Table 1.

Parameter	Test Conditions/Comments	Min	Typ	Max	Unit	
<b>DYNAMIC PERFORMANCE</b>						
Signal-to-Noise Ratio (SNR) <sup>1, 2</sup>	$f_{IN} = 1$ kHz sine wave, unless otherwise noted					
	No oversampling, $\pm 10$ V range	84.5	85		dB	
	OSR = 2, $\pm 10$ V range, <sup>3</sup> $f_{SAMPLE} = 500$ kSPS		85.3		dB	
Signal-to-Noise-and-Distortion (SINAD) <sup>1</sup>	OSR = 4, $\pm 10$ V range <sup>3</sup>		85.5		dB	
	No oversampling, $\pm 5$ V range	84	84.5		dB	
	No oversampling, $\pm 2.5$ V range	83	83.5		dB	
	No oversampling, $\pm 10$ V range	84	84.5		dB	
	No oversampling, $\pm 5$ V range	83.5	84		dB	
	No oversampling, $\pm 2.5$ V range	82.5	83.5		dB	
Dynamic Range	No oversampling, $\pm 10$ V range		85.5		dB	
	No oversampling, $\pm 5$ V range		85.1		dB	
	No oversampling, $\pm 2.5$ V range		84.5		dB	
Total Harmonic Distortion (THD) <sup>1</sup>	No oversampling, $\pm 10$ V range		-103	-93.5	dB	
	No oversampling, $\pm 5$ V range		-100		dB	
	No oversampling, $\pm 2.5$ V range		-97		dB	
Peak Harmonic or Spurious Noise <sup>1</sup>			-103		dB	
Intermodulation Distortion (IMD) <sup>1</sup>	$f_a = 1$ kHz, $f_b = 1.1$ kHz					
		Second-Order Terms		-105		dB
		Third-Order Terms		-113		dB
Channel to Channel Isolation <sup>1</sup>	$f_{IN}$ on unselected channels up to 5 kHz		-106		dB	
<b>ANALOG INPUT FILTER</b>						
Full Power Bandwidth	-3 dB, $\pm 10$ V range		39		kHz	
	-3 dB, $\pm 5$ V/ $+2.5$ V range		33		kHz	
Phase Delay <sup>1, 3</sup>	-0.1 dB		5.5		kHz	
	$\pm 10$ V range		4.4	6	$\mu\text{s}$	
	$\pm 5$ V range		5		$\mu\text{s}$	
Drift <sup>1, 3</sup>	$\pm 2.5$ V range		4.9		$\mu\text{s}$	
	$\pm 10$ V range		$\pm 0.55$	+5	ns/ $^\circ\text{C}$	
Matching (Dual Simultaneous Pair) <sup>1, 3</sup>	$\pm 10$ V range		4.4	100	ns	
	$\pm 5$ V range		4.7		ns	
	$\pm 2.5$ V range		4.1		ns	
<b>DC ACCURACY</b>						
Resolution	No missing codes	14			Bits	
Differential Nonlinearity (DNL) <sup>1</sup>			$\pm 0.1$	$\pm 0.99$	LSB <sup>4</sup>	
Integral Nonlinearity (INL) <sup>1</sup>			$\pm 0.3$	$\pm 1$	LSB	
Total Unadjusted Error (TUE)	$\pm 10$ V range		$\pm 1.5$		LSB	
	$\pm 5$ V range		$\pm 2$		LSB	
	$\pm 2.5$ V range		$\pm 2.5$		LSB	
Positive Full-Scale Error (PFS) <sup>5</sup>	$\pm 10$ V range		$\pm 1.25$	$\pm 8$	LSB	
	$\pm 5$ V range		$\pm 1$		LSB	
	$\pm 2.5$ V range		$\pm 0.5$		LSB	
Internal Reference	$\pm 10$ V range		$\pm 1.25$		LSB	

Parameter	Test Conditions/Comments	Min	Typ	Max	Unit
Drift <sup>3</sup>	External reference		±2	±5	ppm/°C
	Internal reference		±3	±10	ppm/°C
Matching <sup>1</sup>	±10 V range		1	3	LSB
	±5 V range		1		LSB
	±2.5 V range		1		LSB
Bipolar Zero Code Error <sup>1</sup>	±10 V range		±0.15	±2.5	LSB
	±5 V range		±0.2	±2.5	LSB
	±2.5 V range		±0.7	±3.5	LSB
Drift <sup>3</sup>	±10 V range		±1.5	±21	μV/°C
	±5 V range		±1		μV/°C
	±2.5 V range		±0.5		μV/°C
Matching <sup>1</sup>	±10 V range		±0.5	±2.5	LSB
	±5 V range		±0.75		LSB
	±2.5 V range		±0.75		LSB
Negative Full-Scale (NFS) Error <sup>1,5</sup>	External reference				
	±10 V range		±1	±8	LSB
	±5 V range		±0.75		LSB
	±2.5 V range		±1.5		LSB
Drift <sup>3</sup>	Internal reference				
	±10 V range		±1		LSB
	External reference		±2	±5	ppm/°C
Matching <sup>1</sup>	Internal reference		±4	±10	ppm/°C
	±10 V range		1	3	LSB
	±5 V range		1		LSB
	±2.5 V range		2		LSB
<b>ANALOG INPUT</b>					
Input Voltage Ranges	Software/hardware selectable, ±10 V range			±10	V
	Software/hardware selectable, ±5 V range			±5	V
	Software/hardware selectable, ±2.5 V range			±2.5	V
Analog Input Current	±10 V range, see Figure 34		±10.5		μA
	±5 V range, see Figure 34		±6.5		μA
	±2.5 V range, see Figure 34		±4		μA
Input Capacitance <sup>6</sup>			10		pF
Input Impedance	See the Analog Input section	0.85	1		MΩ
Input Impedance Drift <sup>3</sup>				25	ppm/°C
<b>REFERENCE INPUT/OUTPUT</b>					
Reference Input Voltage Range	See the ADC Transfer Function section	2.495	2.5	2.505	V
DC Leakage Current				±1	μA
Input Capacitance <sup>6</sup>	REFSEL = 1		7.5		pF
Reference Output Voltage	Measured at REFINOUT	2.495		2.505	V
Reference Temperature Coefficient <sup>3</sup>			±2	±15	ppm/°C
<b>LOGIC INPUTS</b>					
Input Voltage High (V <sub>INH</sub> )	V <sub>DRIVE</sub> = 2.7 V to 3.6 V	2			V
	V <sub>DRIVE</sub> = 2.3 V to 2.7 V	1.7			V
Input Voltage Low (V <sub>INL</sub> )	V <sub>DRIVE</sub> = 2.7 V to 3.6 V			0.8	V
	V <sub>DRIVE</sub> = 2.3 V to 2.7 V			0.7	V
Input Current (I <sub>IN</sub> )				±1	μA
Input Capacitance (C <sub>IN</sub> ) <sup>6</sup>			5		pF

Parameter	Test Conditions/Comments	Min	Typ	Max	Unit
<b>LOGIC OUTPUTS</b>					
Output Voltage					
High ( $V_{OH}$ )	$I_{SOURCE} = 100 \mu A$	$V_{DRIVE} - 0.2$			V
Low ( $V_{OL}$ )	$I_{SINK} = 100 \mu A$			0.4	V
Floating State Leakage Current			$\pm 0.005$	$\pm 1$	$\mu A$
Floating State Output Capacitance <sup>6</sup>			5		pF
Output Coding	Twos complement				
<b>CONVERSION RATE</b>					
Conversion Time	Per channel pair		0.5		$\mu s$
Acquisition Time	Per channel pair		0.5		$\mu s$
Throughput Rate	Per channel pair			1	MSPS
<b>POWER REQUIREMENTS</b>					
$V_{CC}$		4.75		5.25	V
$V_{DRIVE}$		2.3		3.6	V
$I_{VCC}$					
Normal Mode					
Static			37	57	mA
Operational	$f_{SAMPLE} = 1 \text{ MSPS}$		42	65	mA
Shutdown Mode			28		$\mu A$
$I_{DRIVE}$	Digital inputs = 0 V or $V_{DRIVE}$				
Normal Mode					
Static			0.3	0.75	mA
Operational	$f_{SAMPLE} = 1 \text{ MSPS}$		2.4	3.2	mA
Shutdown Mode			20		$\mu A$
Power Dissipation					
Normal Mode					
Static			185	300	mW
Operational	$f_{SAMPLE} = 1 \text{ MSPS}$		230	350	mW
Shutdown Mode			0.25		mW

<sup>1</sup> See the Terminology section.

<sup>2</sup> The user can achieve 85.3 dB SNR by enabling oversampling. The values are valid for manual mode. In burst mode, values degrade by ~1 dB.

<sup>3</sup> Not production tested. Sample tested during initial release to ensure compliance.

<sup>4</sup> LSB means least significant bit. With a  $\pm 2.5$  V input range, 1 LSB = 305.175  $\mu V$ . With a  $\pm 5$  V input range, 1 LSB = 610.351  $\mu V$ . With a  $\pm 10$  V input range, 1 LSB = 1.220 mV.

<sup>5</sup> Positive and negative full-scale error for the internal reference excludes reference errors.

<sup>6</sup> Supported by simulation data.

## TIMING SPECIFICATIONS

## Universal Timing Specifications

$V_{CC} = 4.75\text{ V to }5.25\text{ V}$ ,  $V_{DRIVE} = 2.3\text{ V to }3.6\text{ V}$ ,  $V_{REF} = 2.5\text{ V}$  external reference/internal reference,  $T_A = -40^\circ\text{C to }+125^\circ\text{C}$ , unless otherwise noted. Interface timing tested using a load capacitance ( $C_{LOAD}$ ) of 30 pF, dependent on  $V_{DRIVE}$  and load capacitance for serial interface (see Table 15).

Table 2.

Parameter <sup>1</sup>	Min	Typ	Max	Unit	Description
$t_{CYCLE}$	1			$\mu\text{s}$	Minimum time between consecutive CONVST rising edges (excluding burst and oversampling modes)
$t_{CONV\_LOW}$	50			ns	CONVST low pulse width
$t_{CONV\_HIGH}$	50			ns	CONVST high pulse width
$t_{BUSY\_DELAY}$			32	ns	CONVST high to BUSY high (manual mode)
$t_{CS\_SETUP}$	20			ns	BUSY falling edge to $\overline{CS}$ falling edge setup time
$t_{CH\_SETUP}$	50			ns	Channel select setup time in hardware mode for CHSELx
$t_{CH\_HOLD}$	20			ns	Channel select hold time in hardware mode for CHSELx
$t_{CONV}$		475	520	ns	Conversion time for the selected channel pair
$t_{ACQ}$	480			ns	Acquisition time for the selected channel pair
$t_{QUIET}$	50			ns	$\overline{CS}$ rising edge to next CONVST rising edge
$t_{RESET\_LOW}$					
Partial Reset	40		500	ns	Partial $\overline{RESET}$ low pulse width
Full Reset	1.2			$\mu\text{s}$	Full $\overline{RESET}$ low pulse width
$t_{DEVICE\_SETUP}$					
Partial Reset	50			ns	Time between partial $\overline{RESET}$ high and CONVST rising edge
Full Reset	15			ms	Time between full $\overline{RESET}$ high and CONVST rising edge
$t_{WRITE}$					
Partial Reset	50			ns	Time between partial $\overline{RESET}$ high and $\overline{CS}$ for write operation
Full Reset	240			$\mu\text{s}$	Time between full $\overline{RESET}$ high and $\overline{CS}$ for write operation
$t_{RESET\_WAIT}$	1			ms	Time between stable $V_{CC}/V_{DRIVE}$ and release of $\overline{RESET}$ (see Figure 51)
$t_{RESET\_SETUP}$					Time prior to release of $\overline{RESET}$ that queried hardware inputs must be stable for (see Figure 51)
Partial Reset	10			ns	
Full Reset	0.05			ms	
$t_{RESET\_HOLD}$					Time after release of $\overline{RESET}$ that queried hardware inputs must be stable for (see Figure 51)
Partial Reset	10			ns	
Full Reset	0.24			ms	

<sup>1</sup> Not production tested. Sample tested during initial release to ensure compliance.

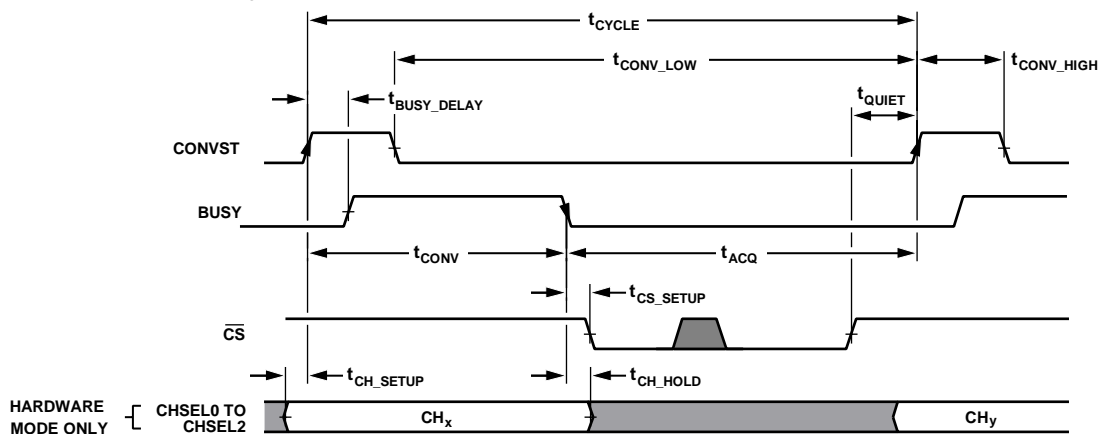

Figure 2. Universal Timing Diagram Across All Interfaces

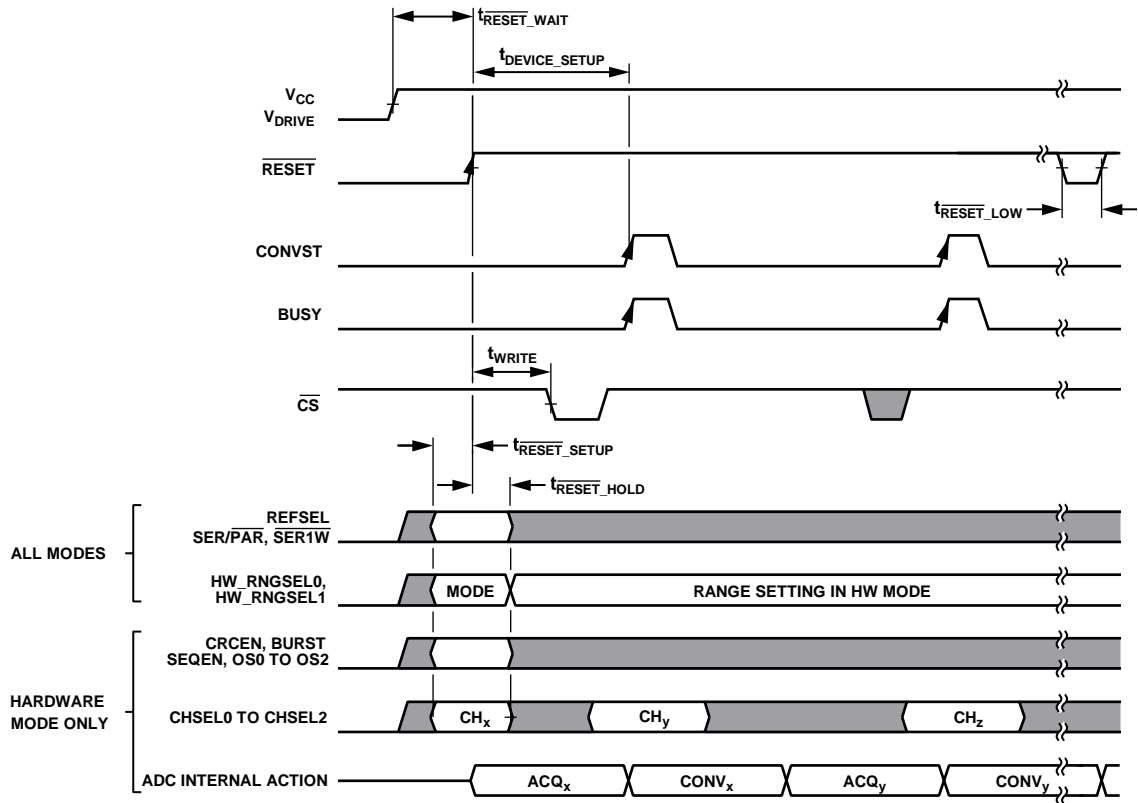

Figure 3. Reset Timing

16077-103

**Parallel Mode Timing Specifications**

Table 3.

Parameter	Min	Typ	Max	Unit	Description
$t_{RD\_SETUP}$	10			ns	$\overline{CS}$ falling edge to $\overline{RD}$ falling edge setup time
$t_{RD\_HOLD}$	10			ns	$\overline{RD}$ rising edge to $\overline{CS}$ rising edge hold time
$t_{RD\_HIGH}$	10			ns	$\overline{RD}$ high pulse width
$t_{RD\_LOW}$	30			ns	$\overline{RD}$ low pulse width
$t_{DOUT\_SETUP}$			30	ns	Data access time after falling edge of $\overline{RD}$
$t_{DOUT\_3STATE}$			11	ns	$\overline{CS}$ rising edge to $\overline{DBx}$ high impedance
$t_{WR\_SETUP}$	10			ns	$\overline{CS}$ to $\overline{WR}$ setup time
$t_{WR\_HIGH}$	20			ns	$\overline{WR}$ high pulse width
$t_{WR\_LOW}$	30			ns	$\overline{WR}$ low pulse width
$t_{WR\_HOLD}$	10			ns	$\overline{WR}$ hold time
$t_{DIN\_SETUP}$	30			ns	Configuration data to $\overline{WR}$ setup time
$t_{DIN\_HOLD}$	10			ns	Configuration data to $\overline{WR}$ hold time
$t_{CONF\_SETTLE}$	20			ns	Configuration data settle time, $\overline{WR}$ rising edge to $\overline{CONVST}$ rising edge

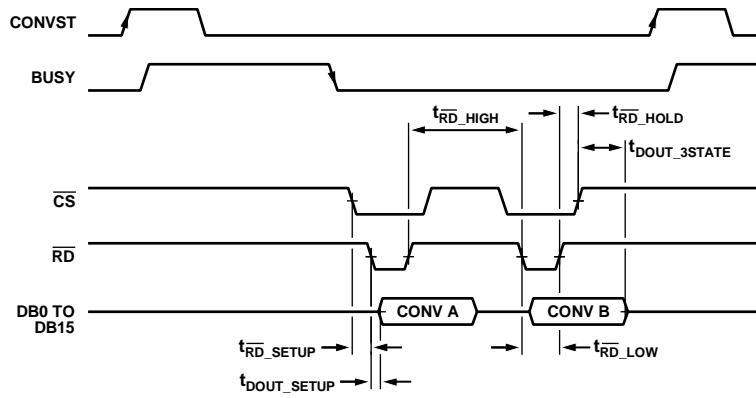

Figure 4. Parallel Read Timing Diagram

18077-104

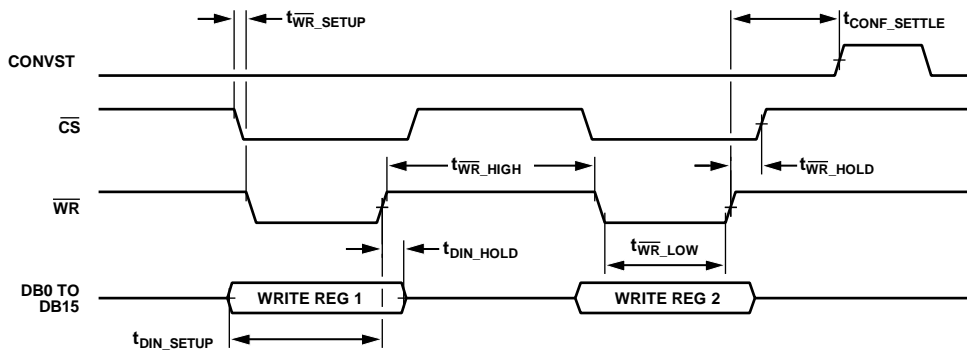

Figure 5. Parallel Write Timing Diagram

18077-105

**Serial Mode Timing Specifications**

**Table 4.**

Parameter	Min	Typ	Max	Unit	Description
$f_{SCLK}^1$			40/50	MHz	SCLK frequency
$t_{SCLK}$		$1/f_{SCLK}$			Minimum SCLK period
$t_{SCLK\_SETUP}^1$	10.5			ns	$\overline{CS}$ to SCLK falling edge setup time, $V_{DRIVE}$ above 3 V
	13.5			ns	$\overline{CS}$ to SCLK falling edge setup time, $V_{DRIVE}$ above 2.3 V
$t_{SCLK\_HOLD}$	10			ns	SCLK to $\overline{CS}$ rising edge hold time
$t_{SCLK\_LOW}$	8			ns	SCLK low pulse width
$t_{SCLK\_HIGH}$	9			ns	SCLK high pulse width
$t_{DOUT\_SETUP}^1$		9		ns	Data out access time after SCLK rising edge, $V_{DRIVE}$ above 3 V
		11		ns	Data out access time after SCLK rising edge, $V_{DRIVE}$ above 2.3 V
$t_{DOUT\_HOLD}$	4			ns	Data out hold time after SCLK rising edge
$t_{DIN\_SETUP}$	10			ns	Data in setup time before SCLK falling edge
$t_{DIN\_HOLD}$	8			ns	Data in hold time after SCLK falling edge
$t_{DOUT\_3STATE}$			10	ns	$\overline{CS}$ rising edge to SDOx high impedance

<sup>1</sup> Dependent on  $V_{DRIVE}$  and  $C_{LOAD}$  (see Table 15).



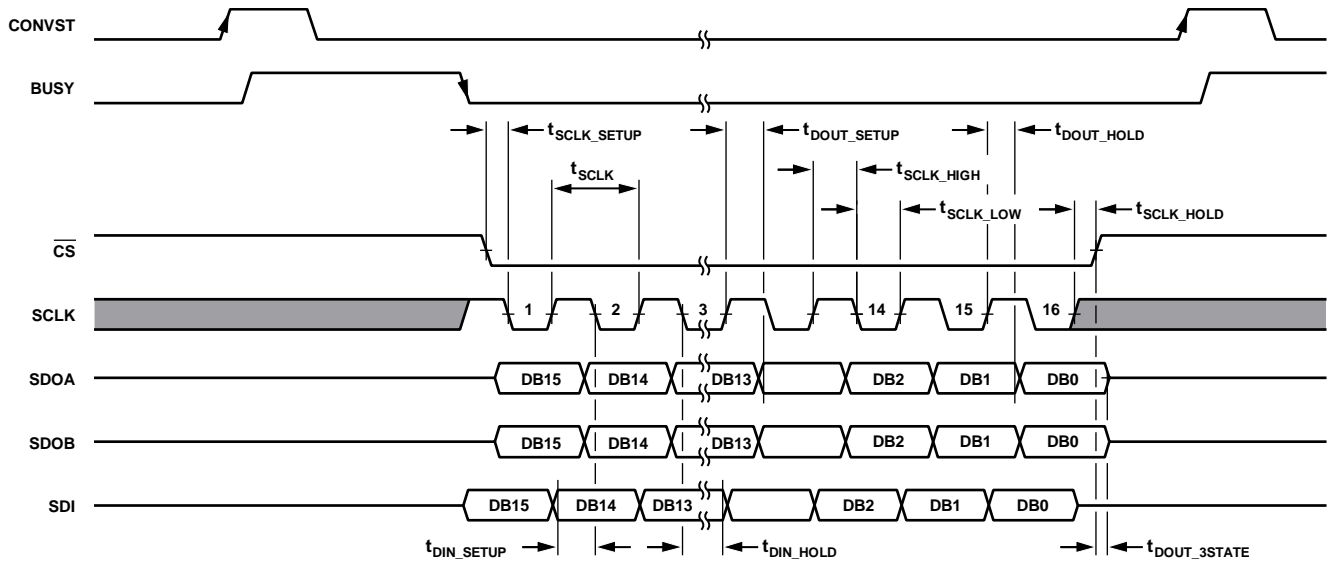

Figure 6. Serial Timing Diagram

16077-106

## ABSOLUTE MAXIMUM RATINGS

$T_A = 25^\circ\text{C}$ , unless otherwise noted.

Table 5.

Parameter	Rating
$V_{CC}$ to AGND	-0.3 V to +7 V
$V_{DRIVE}$ to AGND	-0.3 V to $V_{CC} + 0.3$ V
Analog Input Voltage to AGND <sup>1</sup>	$\pm 21$ V
Digital Input Voltage to AGND	-0.3 V to $V_{DRIVE} + 0.3$ V
Digital Output Voltage to AGND	-0.3 V to $V_{DRIVE} + 0.3$ V
REFINOUT to AGND	-0.3 V to $V_{CC} + 0.3$ V
Input Current to Any Pin Except Supplies <sup>1</sup>	$\pm 10$ mA
Operating Temperature Range	-40°C to +125°C
Storage Temperature Range	-65°C to +150°C
Junction Temperature	150°C
Soldering Reflow	
Pb/Sn Temperature (10 sec to 30 sec)	240 (+0)°C
Pb-Free Temperature	260 (+0)°C
ESD	
All Pins Except Analog Inputs	2 kV
Analog Input Pins Only	8 kV

<sup>1</sup> Transient currents of up to 100 mA do not cause silicon controlled rectifier (SCR) latch-up.

Stresses at or above those listed under Absolute Maximum Ratings may cause permanent damage to the product. This is a stress rating only; functional operation of the product at these or any other conditions above those indicated in the operational section of this specification is not implied. Operation beyond the maximum operating conditions for extended periods may affect product reliability.

## THERMAL RESISTANCE

Thermal performance is directly linked to printed circuit board (PCB) design and operating environment. Close attention to PCB thermal design is required.

$\theta_{JA}$  is the natural convection junction to ambient thermal resistance measured in a one cubic foot sealed enclosure.  $\theta_{JC}$  is the junction to case thermal resistance.

Table 6. Thermal Resistance

Package Type	$\theta_{JA}$	$\theta_{JC}$	Unit
ST-80-2 <sup>1</sup>	41	7.5	°C/W

<sup>1</sup> Thermal impedance simulated values are based on a JEDEC 252P thermal test board. See JEDEC JESD51.

## ESD CAUTION



**ESD (electrostatic discharge) sensitive device.** Charged devices and circuit boards can discharge without detection. Although this product features patented or proprietary protection circuitry, damage may occur on devices subjected to high energy ESD. Therefore, proper ESD precautions should be taken to avoid performance degradation or loss of functionality.

# PIN CONFIGURATION AND FUNCTION DESCRIPTIONS

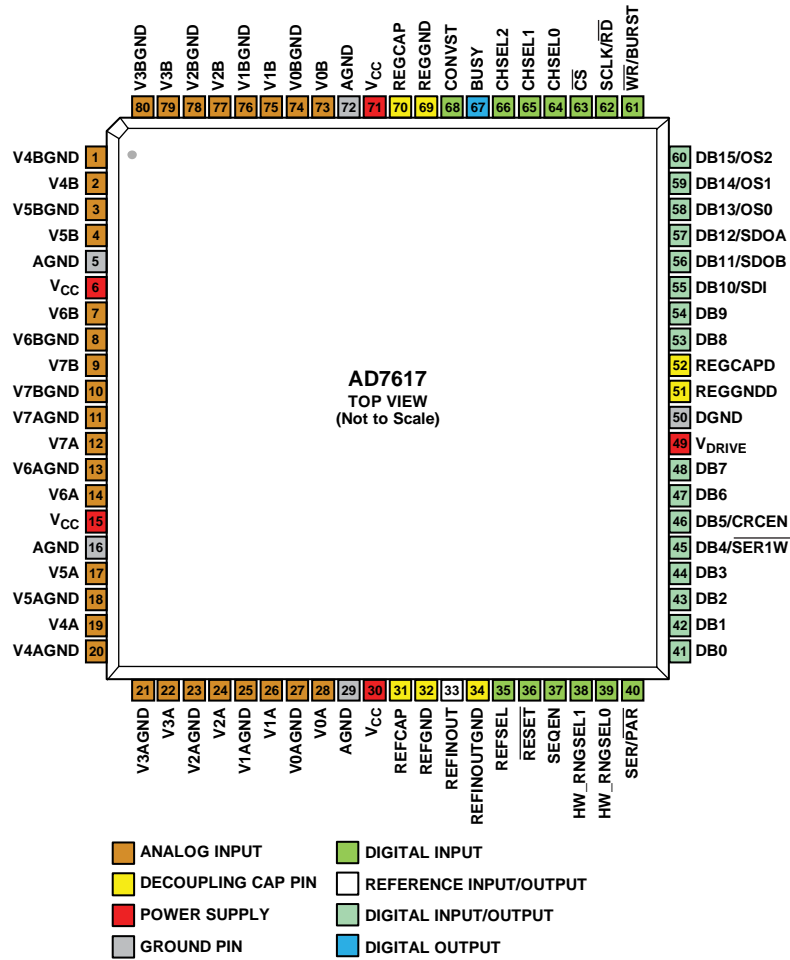

Figure 7. Pin Configuration

Table 7. Pin Function Descriptions

Pin No.	Type <sup>1</sup>	Mnemonic <sup>2</sup>	Description
1	AI GND	V4BGND	Analog Input Ground Pin. This pin corresponds to Analog Input Pin V4B.
2	AI	V4B	Analog Input for Channel 4, ADC B.
3	AI GND	V5BGND	Analog Input Ground Pin. This pin corresponds to Analog Input Pin V5B.
4	AI	V5B	Analog Input for Channel 5, ADC B.
5, 16, 29, 72	GND	AGND	Analog Supply Ground Pin.
6, 15, 30, 71	P	V <sub>CC</sub>	Analog Supply Voltage, 4.75 V to 5.25 V. This supply voltage is applied to the internal front-end amplifiers and to the ADC core. Decouple these pins to AGND using 0.1 μF and 10 μF capacitors in parallel.
7	AI	V6B	Analog Input for Channel 6, ADC B.
8	AI GND	V6BGND	Analog Input Ground Pin. This pin corresponds to Analog Input Pin V6B.
9	AI	V7B	Analog Input for Channel 7, ADC B.
10	AI GND	V7BGND	Analog Input Ground Pin. This pin corresponds to Analog Input Pin V7B.
11	AI GND	V7AGND	Analog Input Ground Pin. This pin corresponds to Analog Input Pin V7A.
12	AI	V7A	Analog Input for Channel 7, ADC A.
13	AI GND	V6AGND	Analog Input Ground Pin. This pin corresponds to Analog Input Pin V6A.
14	AI	V6A	Analog Input for Channel 6, ADC A.
17	AI	V5A	Analog Input for Channel 5, ADC A.
18	AI GND	V5AGND	Analog Input Ground Pin. This pin corresponds to Analog Input Pin V5A.
19	AI	V4A	Analog Input for Channel 4, ADC A.
20	AI GND	V4AGND	Analog Input Ground Pin. This pin corresponds to Analog Input Pin V4A.

Pin No.	Type <sup>1</sup>	Mnemonic <sup>2</sup>	Description
21	AI GND	V3AGND	Analog Input Ground Pin. This pin corresponds to Analog Input Pin V3A.
22	AI	V3A	Analog Input for Channel 3, ADC A.
23	AI GND	V2AGND	Analog Input Ground Pin. This pin corresponds to Analog Input Pin V2A.
24	AI	V2A	Analog Input for Channel 2, ADC A.
25	AI GND	V1AGND	Analog Input Ground Pin. This pin corresponds to Analog Input Pin V1A.
26	AI	V1A	Analog Input for Channel 1, ADC A.
27	AI GND	VOAGND	Analog Input Ground Pin. This pin corresponds to Analog Input Pin V0A.
28	AI	VOA	Analog Input for Channel 0, ADC A.
31	CAP	REFCAP	Reference Buffer Output Force/Sense Pin. Decouple this pin to REFGND using a low effective series resistance (ESR), 10 $\mu$ F, X5R ceramic capacitor, as close to the REFCAP pin as possible. The voltage on this pin is typically 4.096 V.
32	CAP	REFGND	Reference Ground Pin. Connect this pin to AGND.
33	REF	REFINOUT	Reference Input/Reference Output. The on-chip reference of 2.5 V is available on this pin for external use when the REFSEL pin is set to logic high. Alternatively, the internal reference can be disabled by setting the REFSEL pin to logic low, and an external reference of 2.5 V can be applied to this input. Decoupling is required on this pin for both the internal and external reference options. Connect a 100 nF, X7R capacitor between the REFINOUT and REFINOUTGND pins, as close to the REFINOUT pin as possible. If using an external reference, connect a 10 k $\Omega$ series resistor to this pin to band limit the reference signal.
34	CAP	REFINOUTGND	Reference Input, Reference Output Ground Pin.
35	DI	REFSEL	Internal/External Reference Selection Input. REFSEL is a logic input. If this pin is set to logic high, the internal reference is selected and enabled. If this pin is set to logic low, the internal reference is disabled, and an external reference voltage must be applied to the REFINOUT pin. The signal state is latched on the release of a full reset and requires an additional full reset to reconfigure.
36	DI	$\overline{\text{RESET}}$	Reset Input. Connect a 100 pF capacitor between $\overline{\text{RESET}}$ and ground. Full and partial reset options are available. The type of reset is determined by the length of the $\overline{\text{RESET}}$ pulse. Keeping $\overline{\text{RESET}}$ low places the device into shutdown mode. See the Reset Functionality section for further details.
37	DI	SEQEN	Channel Sequencer Enable Input (Hardware Mode Only). When SEQEN is tied low, the sequencer is disabled.  When SEQEN is high, the sequencer is enabled (with restricted functionality in hardware mode). See the Sequencer section for further details. The signal state is latched on the release of a full reset, and requires an additional full reset to reconfigure.  In software mode, this pin must be connected to DGND.
38, 39	DI	HW_RNGSEL1, HW_RNGSELO	Hardware/Software Mode Selection, Hardware Mode Range Select Inputs. Hardware/software mode selection is latched at full reset. Range selection in hardware mode is not latched. HW_RNGSELx = 00: software mode; the AD7617 is configured via the software registers. HW_RNGSELx = 01: hardware mode; analog input range is $\pm 2.5$ V. HW_RNGSELx = 10: hardware mode; analog input range is $\pm 5$ V. HW_RNGSELx = 11: hardware mode; analog input range is $\pm 10$ V.
40	DI	SER/ $\overline{\text{PAR}}$	Serial/Parallel Interface Selection Input. Logic input. If this pin is tied to logic low, the parallel interface is selected. If this pin is tied to logic high, the serial interface is selected. The signal state is latched on the release of a full reset, and requires an additional full reset to reconfigure.
41, 42, 43, 44	DO/DI	DB0, DB1, DB2, DB3	Parallel Output/Input Data Bit 0 to Data Bit 3. In parallel mode, DB2 is the LSB of the 14-bit conversion result and DB0 and DB1 output zero. In software parallel mode, DB0, DB1, DB2, and DB3 are the four LSBs of a register write/read operation. In hardware parallel mode, DB0 and DB1 can be left floating or pulled to DGND via a 10 k $\Omega$ pull-down resistor. Refer to the Parallel Interface section for further details. In serial mode, these pins must be tied to DGND.

Pin No.	Type <sup>1</sup>	Mnemonic <sup>2</sup>	Description
45	DO/DI	DB4/ $\overline{\text{SER1W}}$	<p>Parallel Output/Input Data Bit 4/Serial Output Selection. In parallel mode, this pin acts as a three-state parallel digital output/input pin. Refer to the Parallel Interface section for further details.</p> <p>In serial mode, this pin determines whether the serial output operates over SDOA and SDOB or just SDOA. When <math>\overline{\text{SER1W}}</math> is low, the serial output operates over SDOA only. When <math>\overline{\text{SER1W}}</math> is high, the serial output operates over both SDOA and SDOB. The signal state is latched on the release of a full reset, and requires an additional full reset to reconfigure.</p>
46	DO/DI	DB5/CRCEN	<p>Parallel Output/Input Data Bit 5/Cyclic Redundancy Check (CRC) Enable Input. In parallel mode, this pin acts as a three-state parallel digital input/output. While in serial mode, this pin acts as a CRC enable input. The CRCEN signal state is latched on the release of a full reset, and requires an additional full reset to reconfigure. Refer to the Digital Interface section for further details.</p> <p>In serial mode, when CRCEN is low, there is no CRC word following the conversion results; when CRCEN is high, an extra CRC word follows the last conversion word configured by CHSELx. See the CRC section for further details.</p> <p>In software mode, this pin must be connected to DGND.</p>
47, 48	DO/DI	DB6, DB7	<p>Parallel Output/Input Data Bit 6 and Data Bit 7. When <math>\overline{\text{SER/PAR}} = 0</math>, these pins act as three-state parallel digital input/outputs. Refer to the Parallel Interface section for further details. In serial mode, when <math>\overline{\text{SER/PAR}} = 1</math>, these pins must be tied to DGND.</p>
49	P	V <sub>DRIVE</sub>	<p>Logic Power Supply Input. The voltage (2.3 V to 3.6 V) supplied at this pin determines the operating voltage of the interface. This pin is nominally at the same supply as the supply of the host interface. Decouple this pin with 0.1 <math>\mu\text{F}</math> and 10 <math>\mu\text{F}</math> capacitors in parallel.</p>
50	GND	DGND	<p>Digital Ground. This pin is the ground reference point for all digital circuitry on the AD7617. The DGND pin must connect to the DGND plane of a system.</p>
51	CAP	REGGND	<p>Ground for the Digital Low Dropout (LDO) Regulator Connected to REGCAPD (Pin 52).</p>
52	CAP	REGCAPD	<p>Decoupling Capacitor Pin for Voltage Output from Internal Digital Regulator. Decouple this output pin separately to REGGND using a 10 <math>\mu\text{F}</math> capacitor. The voltage at this pin is 1.89 V typical.</p>
53, 54	DO/DI	DB8, DB9	<p>Parallel Output/Input Data Bit 9 and Data Bit 8. When <math>\overline{\text{SER/PAR}} = 0</math>, these pins act as three-state parallel digital input/outputs. Refer to the Parallel Interface section for further details. In serial mode, when <math>\overline{\text{SER/PAR}} = 1</math>, these pins must be tied to DGND.</p>
55	DO/DI	DB10/SDI	<p>Parallel Output/Input Data Bit DB10/Serial Data Input. When <math>\overline{\text{SER/PAR}} = 0</math>, this pin acts as a three-state parallel digital input/output. Refer to the Parallel Interface section for further details. In hardware serial mode, tie this pin to DGND.</p> <p>In serial mode, when <math>\overline{\text{SER/PAR}} = 1</math>, this pin acts as the data input of the SPI interface.</p>
56	DO/DI	DB11/SDOB	<p>Parallel Output/Input Data Bit 11/Serial Data Output B. When <math>\overline{\text{SER/PAR}} = 0</math>, this pin acts as a three-state parallel digital input/output. Refer to the Parallel Interface section for further details.</p> <p>In serial mode, when <math>\overline{\text{SER/PAR}} = 1</math> and <math>\overline{\text{DB4/SER1W}} = 1</math>, this pin functions as SDOB and outputs serial conversion data.</p>
57	DO/DI	DB12/SDOA	<p>Parallel Output/Input Data Bit 12/Serial Data Output A. When <math>\overline{\text{SER/PAR}} = 0</math>, this pin acts as a three-state parallel digital input/output. Refer to the Parallel Interface section for further details.</p> <p>In serial mode, when <math>\overline{\text{SER/PAR}} = 1</math>, this pin functions as SDOA and outputs serial conversion data.</p>
58, 59, 60	DO/DI	DB13/OS0, DB14/OS1, DB15/OS2	<p>Parallel Output/Input Data Bit 13, Data Bit 14, and Data Bit 15/Oversampling Ratio Selection. When <math>\overline{\text{SER/PAR}} = 0</math>, these pins act as three-state parallel digital input/outputs. Refer to the Parallel Interface section for further details.</p> <p>In serial hardware mode, these pins control the oversampling settings. The signal state is latched on the release of a full reset and requires an additional full reset to reconfigure. See the Digital Filter section for further details.</p> <p>In software serial mode, these pins must be connected to DGND.</p>
61	DI	$\overline{\text{WR}}$ /BURST	<p>Write/Burst Mode Enable.</p> <p>In software parallel mode, this pin acts as <math>\overline{\text{WR}}</math> for a parallel interface.</p> <p>In hardware parallel or serial mode, this pin enables BURST mode. The signal state is latched on the release of a full reset, and requires an additional full reset to reconfigure. Refer to the Burst Sequencer section for further information.</p> <p>In software serial mode, connect this pin to DGND.</p>

Pin No.	Type <sup>1</sup>	Mnemonic <sup>2</sup>	Description
62	DI	SCLK/RD	Serial Clock Input/Parallel Data Read Control Input. In serial mode, this pin acts as the serial clock input for data transfers. The $\overline{CS}$ falling edge takes the SDOA and SDOB data output lines out of three-state and clocks out the MSB of the conversion result. The rising edge of SCLK clocks all subsequent data bits onto the SDOA and SDOB serial data outputs. When both $\overline{CS}$ and $\overline{RD}$ are logic low in parallel mode, the output bus is enabled.
63	DI	$\overline{CS}$	Chip Select. This active low logic input frames the data transfer. In parallel mode, when both $\overline{CS}$ and $\overline{RD}$ are logic low, the DBx output bus is enabled, and the conversion result is output on the parallel data bus lines. In serial mode, $\overline{CS}$ frames the serial read transfer and clocks out the MSB of the serial output data.
64, 65, 66	DI	CHSEL0, CHSEL1, CHSEL2	Channel Selection Input 0 to Input 2. In hardware mode, these inputs select the input channels for the next conversion in Channel Group A and Channel Group B. For example, CHSELx = 0x000 selects V0A and V0B for the next conversion; CHSELx = 0x001 selects V1A and V1B for the next conversion. In software mode, these pins must be connected to DGND.
67	DO	BUSY	Busy Output. This pin transitions to a logic high after a CONVST rising edge and indicates that the conversion process started. The BUSY output remains high until the conversion process for the current selected channels completes. The falling edge of BUSY signals that the conversion data is being latched into the output data registers and is available to read. Data must be read after BUSY returns to low. Rising edges on CONVST have no effect while the BUSY signal is high.
68	DI	CONVST	Conversion Start Input for Channel Group A and Channel Group B. This logic input initiates conversions on the analog input channels. A conversion initiates when CONVST transitions from low to high for the selected analog input pair. When burst mode and oversampling mode are disabled, every CONVST transition from low to high converts one channel pair. In sequencer mode, when burst mode or oversampling is enabled, a single CONVST transition from low to high is necessary to perform the required number of conversions.
69	CAP	REGGND	Internal Analog Regulator Ground. This pin must connect to the AGND plane of a system.
70	CAP	REGCAP	Decoupling Capacitor Pin for Voltage Output from Internal Analog Regulator. Decouple this output pin separately to REGGND using a 10 $\mu$ F capacitor. The voltage at this pin is 1.87 V typical.
73	AI	V0B	Analog Input for Channel 0, ADC B.
74	AI GND	V0BGND	Analog Input Ground Pin. This pin corresponds to Analog Input Pin V0B.
75	AI	V1B	Analog Input for Channel 1, ADC B.
76	AI GND	V1BGND	Analog Input Ground Pin. This pin corresponds to Analog Input Pin V1B.
77	AI	V2B	Analog Input for Channel 2, ADC B.
78	AI GND	V2BGND	Analog Input Ground Pin. This pin corresponds to Analog Input Pin V2B.
79	AI	V3B	Analog Input for Channel 3, ADC B.
80	AI GND	V3BGND	Analog Input Ground Pin. This pin corresponds to Analog Input Pin V3B.

<sup>1</sup> AI is analog input, GND is ground, P is power supply, CAP is decoupling capacitor pin, REF is reference input/output, DI is digital input, and DO is digital output.

<sup>2</sup> Note that throughout this data sheet, multifunction pins, such as SER/PAR, are referred to either by the entire pin name or by a single function of the pin, for example, SER, when only that function is relevant.

# TYPICAL PERFORMANCE CHARACTERISTICS

$V_{REF} = 2.5$  V internal,  $V_{CC} = 5$  V,  $V_{DRIVE} = 3.3$  V,  $f_{SAMPLE} = 1$  MSPS,  $f_{IN} = 1$  kHz  $T_A = 25^\circ\text{C}$ , unless otherwise noted.

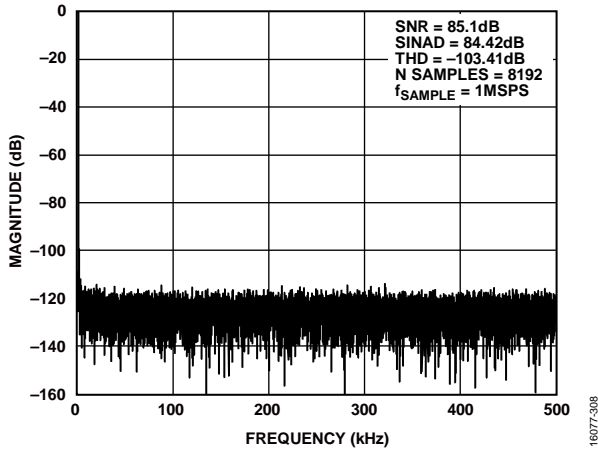

Figure 8. Fast Fourier Transform (FFT),  $\pm 10$  V Range

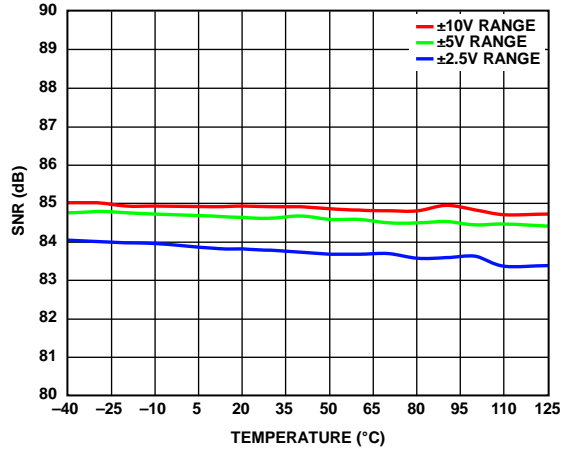

Figure 11. SNR vs. Temperature

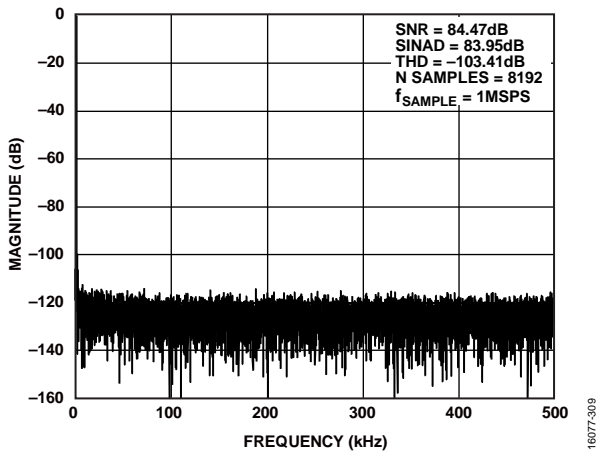

Figure 9. FFT,  $\pm 5$  V Range

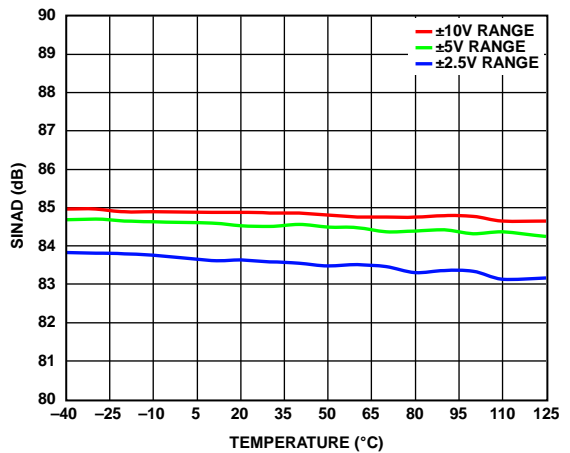

Figure 12. SINAD vs. Temperature

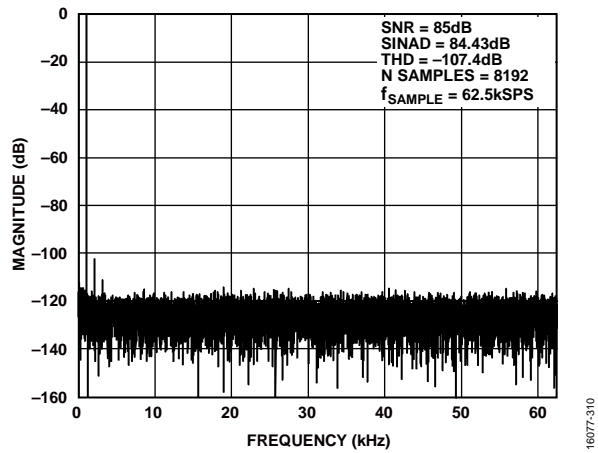

Figure 10. FFT Burst Mode,  $\pm 10$  V Range

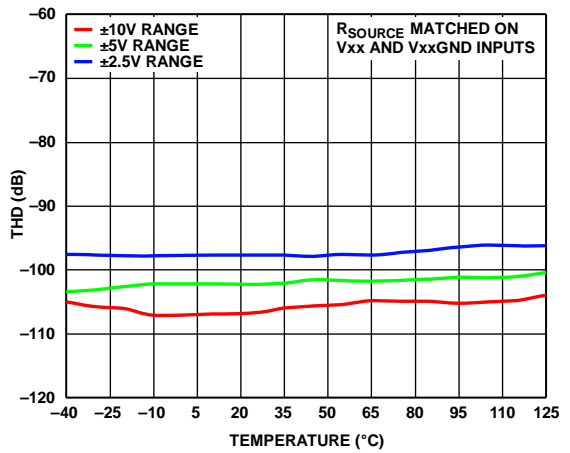

Figure 13. THD vs. Temperature

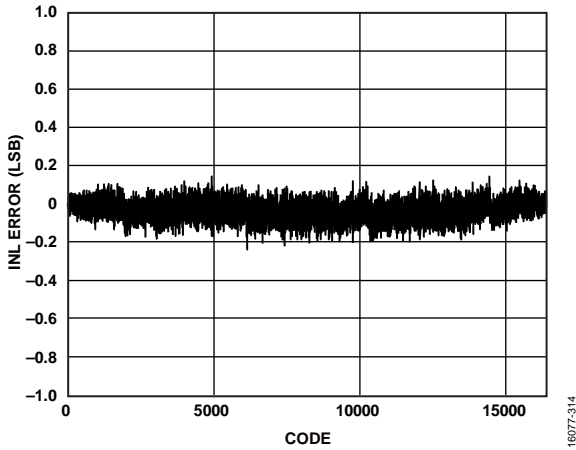

Figure 14. Typical INL Error,  $\pm 10$  V Range

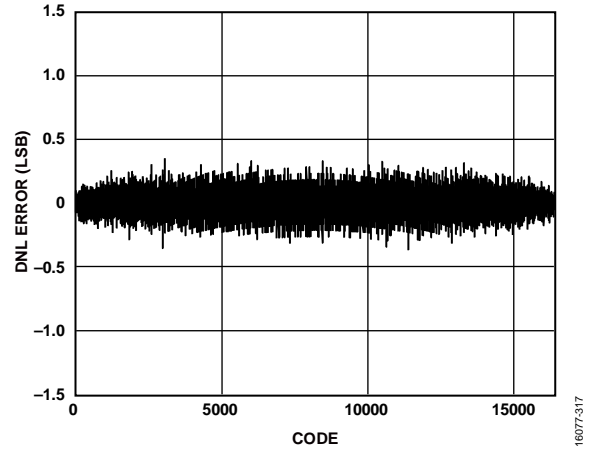

Figure 17. Typical DNL Error,  $\pm 5$  V Range

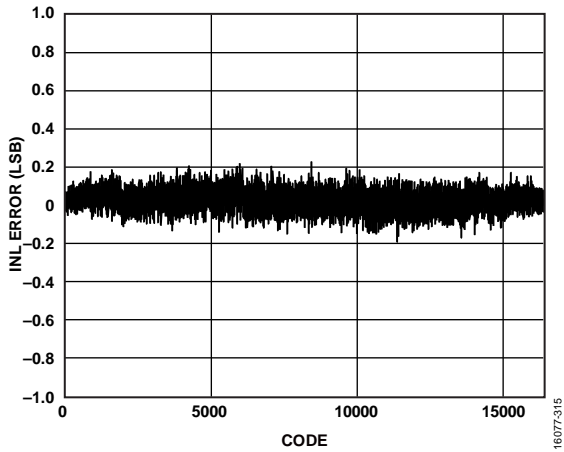

Figure 15. Typical INL Error,  $\pm 5$  V Range

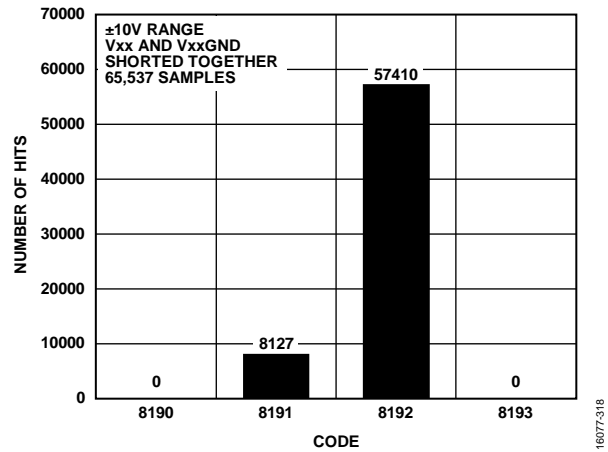

Figure 18. DC Histogram of Codes at Code Center,  $\pm 10$  V Range

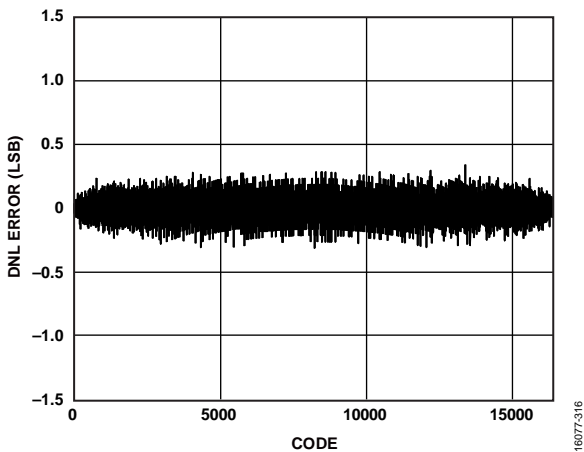

Figure 16. Typical DNL Error,  $\pm 10$  V Range

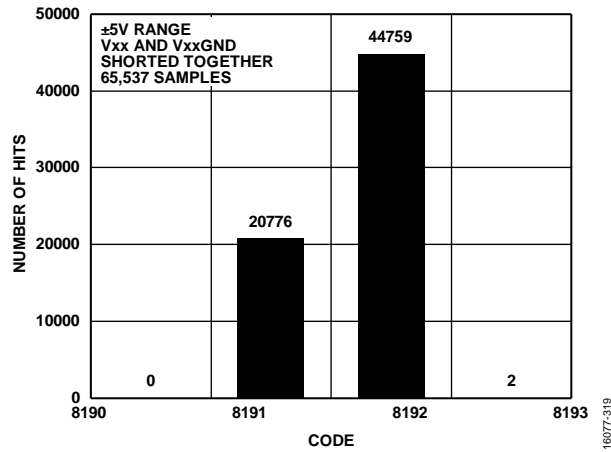

Figure 19. DC Histogram of Codes at Code Center,  $\pm 5$  V Range



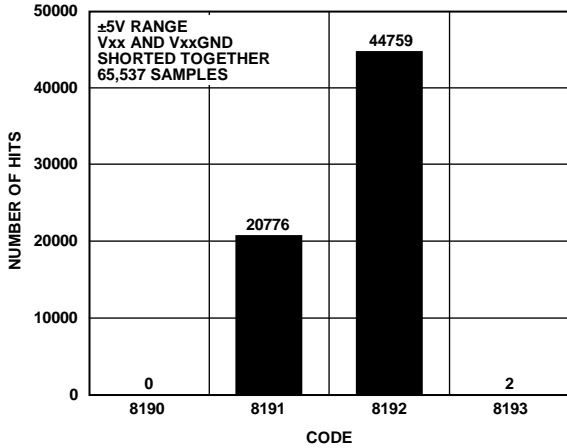

Figure 20. DC Histogram of Codes at Code Center,  $\pm 2.5$  V Range

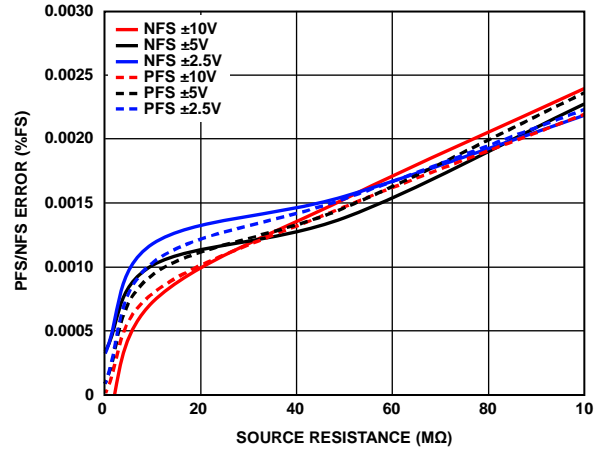

Figure 23. PFS/NFS Error vs. Source Resistance

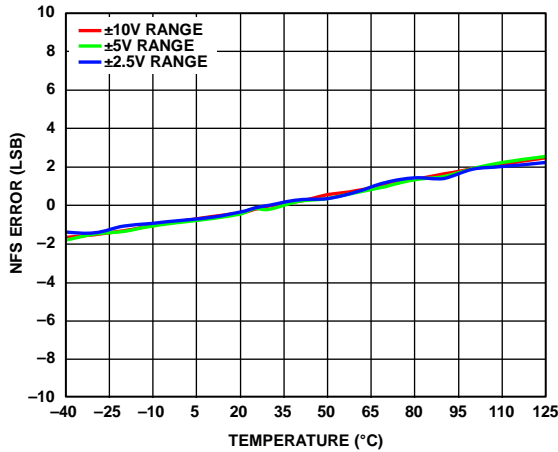

Figure 21. NFS Error vs. Temperature

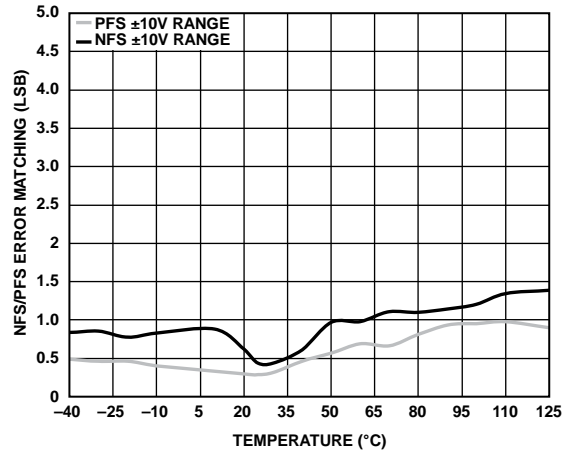

Figure 24. NFS/PFS Error Matching vs. Temperature

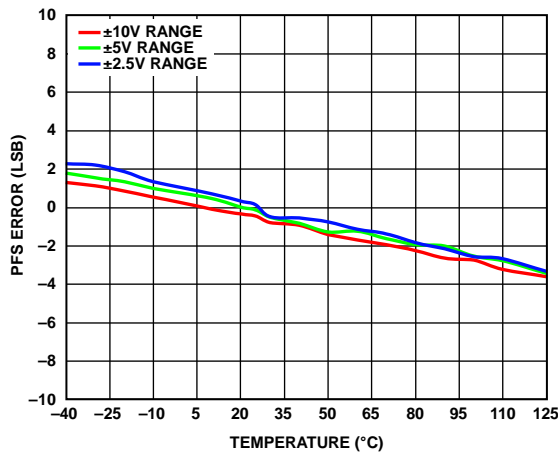

Figure 22. PFS Error vs. Temperature

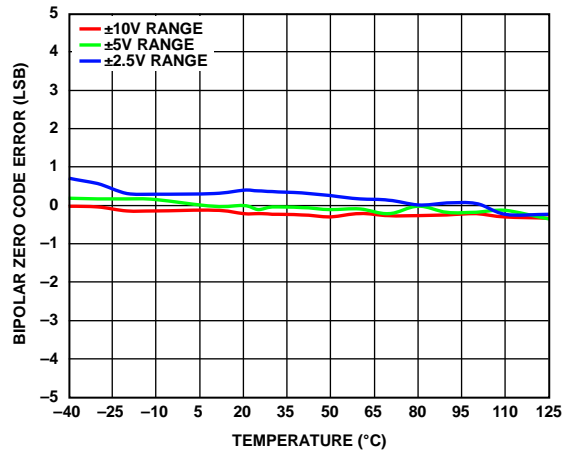

Figure 25. Bipolar Zero Code Error vs. Temperature

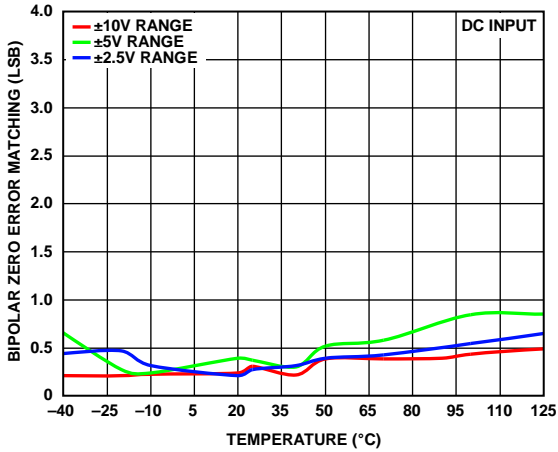

Figure 26. Bipolar Zero Code Error Matching vs. Temperature

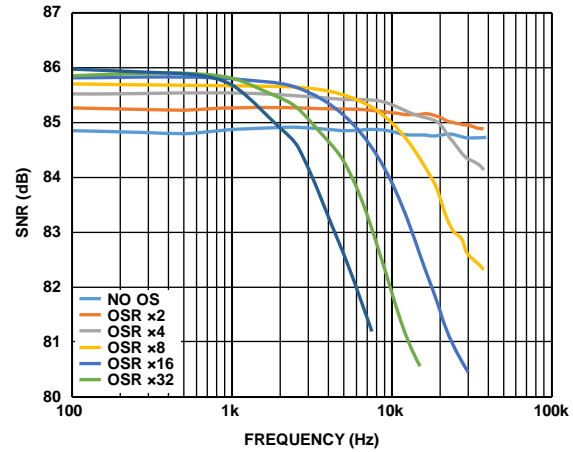

Figure 29. SNR vs. Input Frequency for Different Oversampling Rates, ±10 V Range

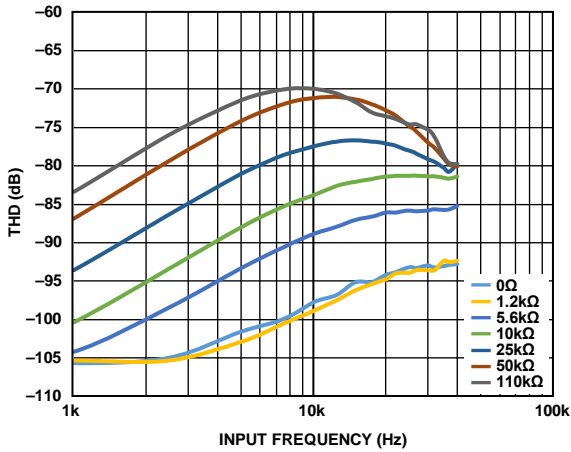

Figure 27. THD vs. Input Frequency for Various Source Impedances, ±10 V Range

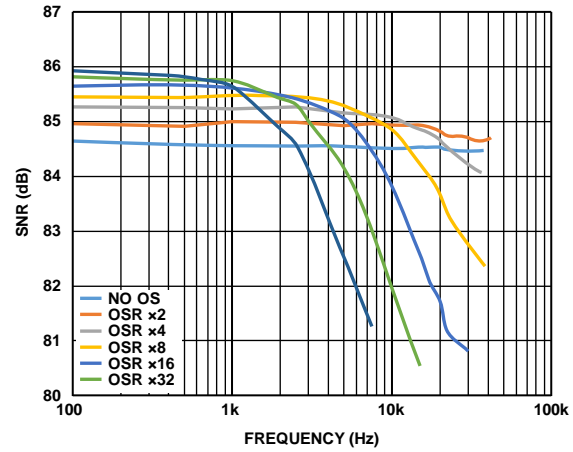

Figure 30. SNR vs. Input Frequency for Different Oversampling Rates, ±5 V Range

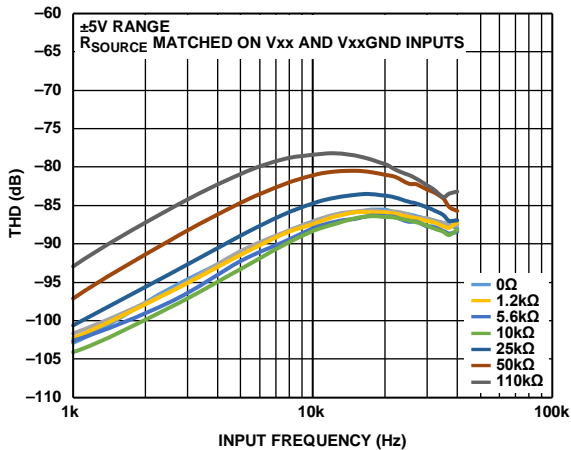

Figure 28. THD vs. Input Frequency for Various Source Impedances, ±5 V Range

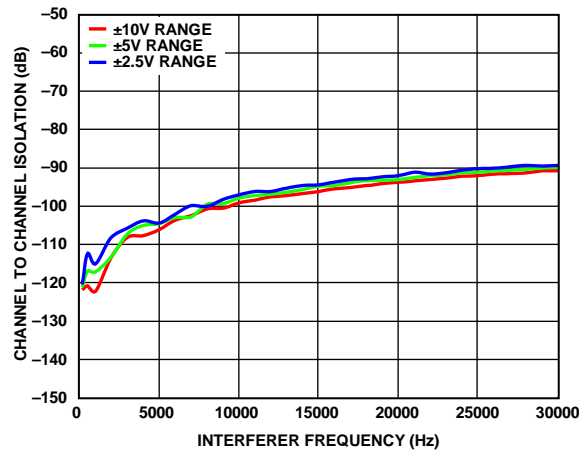

Figure 31. Channel to Channel Isolation vs. Interferer Frequency

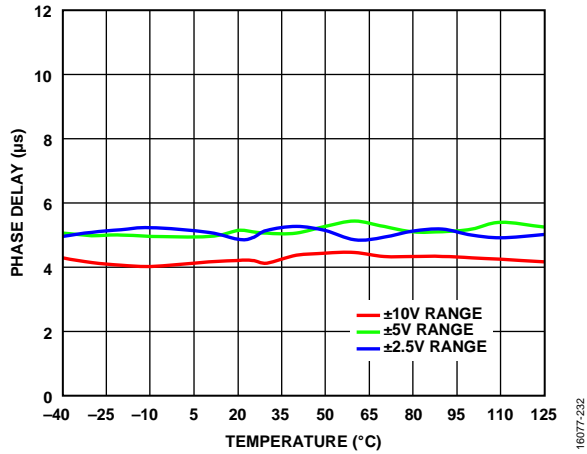

Figure 32. Phase Delay vs. Temperature

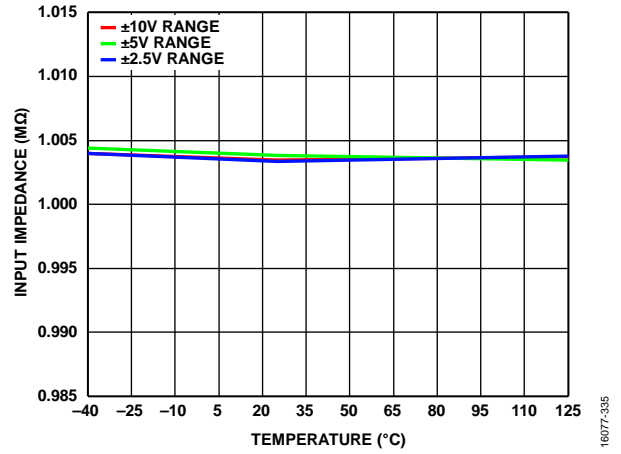

Figure 35. Input Impedance vs. Temperature

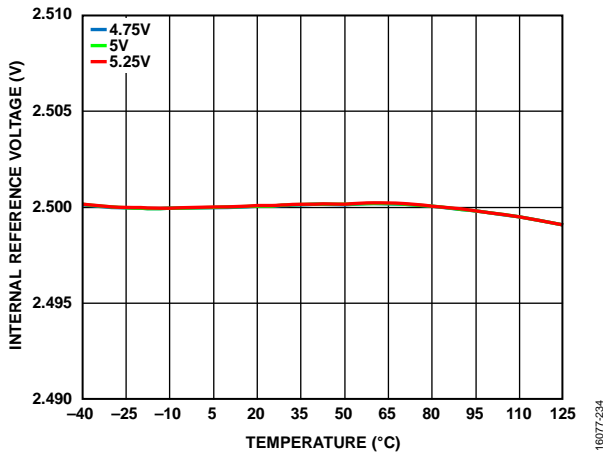

Figure 33. Internal Reference Voltage vs. Temperature for Various Supply Voltages

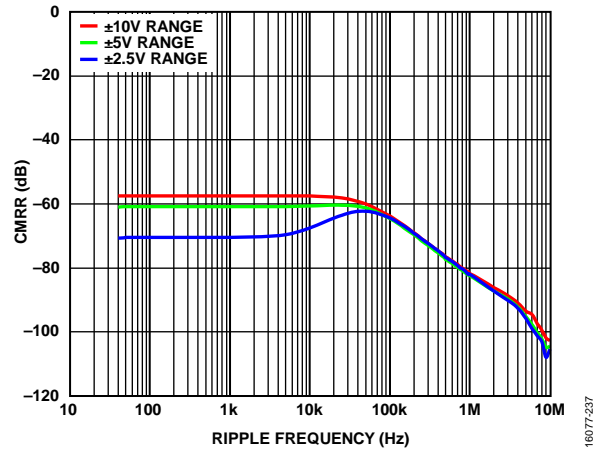

Figure 36. CMRR vs. Ripple Frequency

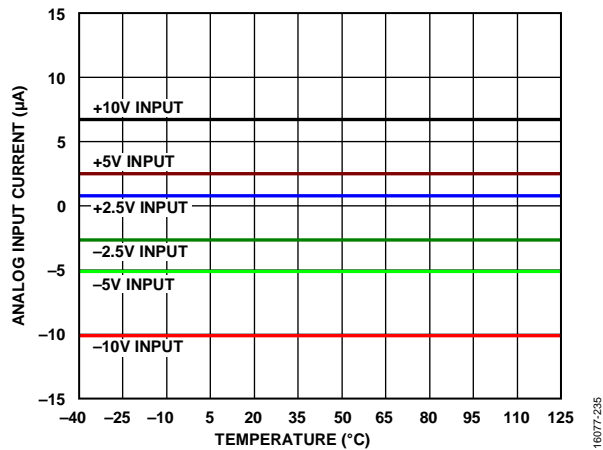

Figure 34. Analog Input Current vs. Temperature for Various Supply Voltages

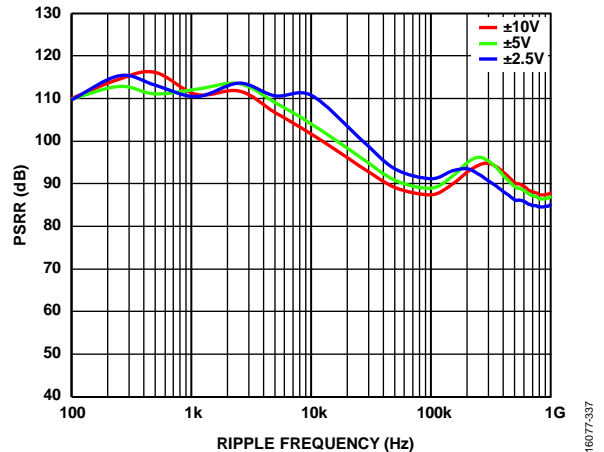

Figure 37. PSRR vs. Ripple Frequency

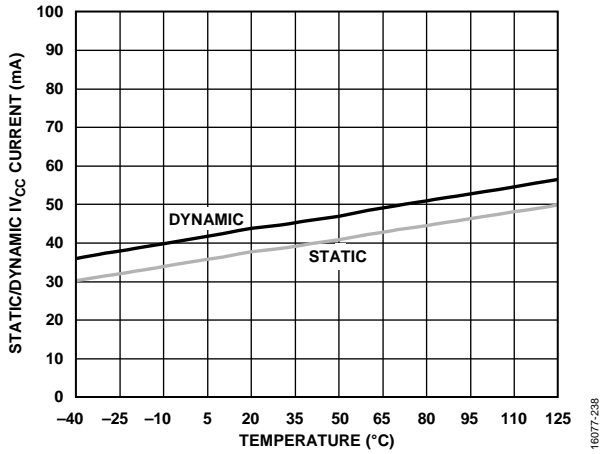

Figure 38. Static/Dynamic IV<sub>CC</sub> Current vs. Temperature

16077-238

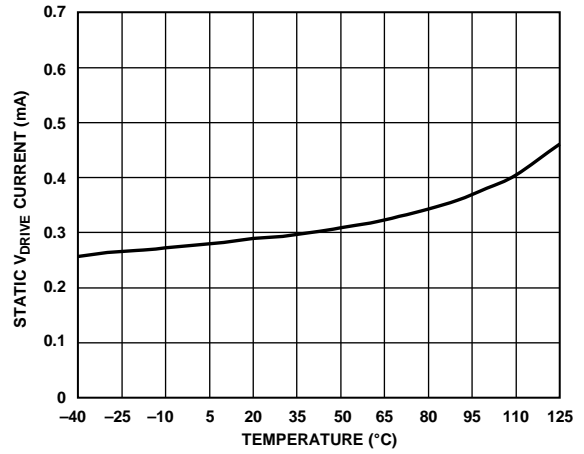

Figure 40. Static V<sub>DRIVE</sub> Current vs. Temperature

16077-240

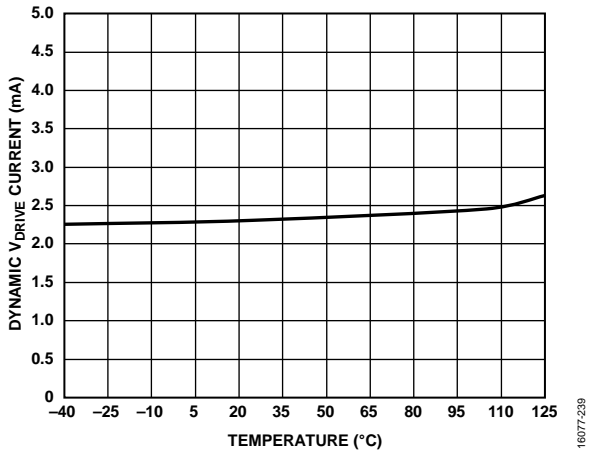

Figure 39. Dynamic V<sub>DRIVE</sub> Current vs. Temperature

16077-239

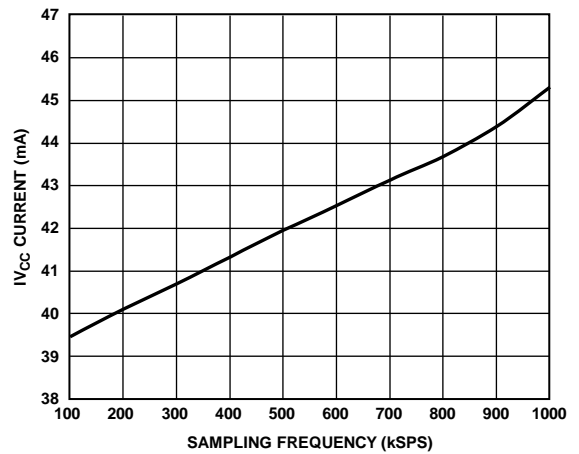

Figure 41. IV<sub>CC</sub> Current vs. Sampling Frequency

16077-241

## TERMINOLOGY

### Integral Nonlinearity (INL)

INL is the maximum deviation from a straight line passing through the endpoints of the ADC transfer function. The endpoints of the transfer function are zero scale at  $\frac{1}{2}$  LSB below the first code transition and full scale at  $\frac{1}{2}$  LSB above the last code transition.

### Differential Nonlinearity (DNL)

DNL is the difference between the measured and the ideal 1 LSB change between any two adjacent codes in the ADC.

### Bipolar Zero Code Error

Bipolar zero code error is the deviation of the midscale transition (all 1s to all 0s) from the ideal, which is  $0\text{ V} - \frac{1}{2}$  LSB.

### Bipolar Zero Code Error Matching

Bipolar zero code error matching is the absolute difference in bipolar zero code error between any two input channels.

### Positive Full-Scale (PFS) Error

Positive full-scale error is the deviation of the actual last code transition from the ideal last code transition ( $10\text{ V} - 1\frac{1}{2}$  LSB (9.99954),  $5\text{ V} - 1\frac{1}{2}$  LSB (4.99977), and  $2.5\text{ V} - 1\frac{1}{2}$  LSB (2.49989)) after bipolar zero code error is adjusted out. The positive full-scale error includes the contribution from the internal reference buffer.

### Positive Full-Scale Error Matching

Positive full-scale error matching is the absolute difference in positive full-scale error between any two input channels.

### Negative Full-Scale (NFS) Error

Negative full-scale error is the deviation of the first code transition from the ideal first code transition ( $-10\text{ V} + \frac{1}{2}$  LSB ( $-9.99985$ ),  $-5\text{ V} + \frac{1}{2}$  LSB ( $-4.99992$ ) and  $-2.5\text{ V} + \frac{1}{2}$  LSB ( $-2.49996$ )) after the bipolar zero code error is adjusted out. The negative full-scale error includes the contribution from the internal reference buffer.

### Negative Full-Scale Error Matching

Negative full-scale error matching is the absolute difference in negative full-scale error between any two input channels.

### Signal-to-Noise-and-Distortion Ratio (SINAD)

SINAD is the measured ratio of signal to noise and distortion at the output of the ADC. The signal is the rms value of the sine wave, and noise is the rms sum of all nonfundamental signals up to half the sampling frequency ( $f_s/2$ ), including harmonics, but excluding dc.

### Signal-to-Noise Ratio (SNR)

SNR is the measured ratio of signal to noise at the output of the ADC. The signal is the rms amplitude of the fundamental. Noise is the sum of all nonfundamental signals up to half the sampling frequency ( $f_s/2$ ), excluding dc.

The ratio is dependent on the number of quantization levels in the digitization process: the greater the number of levels, the smaller the quantization noise. The theoretical SNR for an ideal N-bit converter with a sine wave input is given by

$$\text{SNR} = (6.02N + 1.76) \text{ dB}$$

Therefore, for a 14-bit converter, the SNR is 86 dB.

### Total Harmonic Distortion (THD)

THD is the ratio of the rms sum of the first five harmonic components to the rms value of a full-scale input signal and is expressed in decibels (dB).

### Peak Harmonic or Spurious Noise

The ratio of the rms value of the next largest component in the ADC output spectrum (up to  $f_s/2$ , excluding dc) to the rms value of the fundamental. Normally, the value of this specification is determined by the largest harmonic in the spectrum, but for ADCs where the harmonics are buried in the noise floor, it is determined by a noise peak.

### Intermodulation Distortion

With inputs consisting of sine waves at two frequencies,  $f_a$  and  $f_b$ , any active device with nonlinearities creates distortion products at the sum and difference frequencies of  $m f_a \pm n f_b$ , where  $m, n = 0, 1, 2, 3$ . Intermodulation distortion terms are those for which neither  $m$  nor  $n$  is equal to 0. For example, the second-order terms include  $(f_a + f_b)$  and  $(f_a - f_b)$ , and the third-order terms include  $(2f_a + f_b)$ ,  $(2f_a - f_b)$ ,  $(f_a + 2f_b)$ , and  $(f_a - 2f_b)$ .

The calculation of the intermodulation distortion is per the THD specification, where it is the ratio of the rms sum of the individual distortion products to the rms amplitude of the sum of the fundamentals expressed in decibels (dB).

### Power Supply Rejection Ratio (PSRR)

Variations in power supply affect the full-scale transition but not the linearity of the converter. Power supply rejection is the maximum change in full-scale transition point due to a change in power supply voltage from the nominal value. The PSRR is defined as the ratio of the power in the ADC output at full-scale frequency,  $f$ , to the power of a 100 mV p-p sine wave applied to the  $V_{CC}$  supply of the ADC of frequency,  $f_s$ .

$$\text{PSRR (dB)} = 10 \log(P_f / P_{f_s})$$

where:

$P_f$  is equal to the power at frequency,  $f$ , in the ADC output.

$P_{f_s}$  is equal to the power at frequency,  $f_s$ , coupled onto the  $V_{CC}$  supply.

**AC Common-Mode Rejection Ratio (AC CMRR)**

AC CMRR is defined as the ratio of the power in the ADC output at frequency,  $f$ , to the power of a sine wave applied to the common-mode voltage of  $V_{XX}$  and  $V_{XXGND}$  at frequency,  $f_s$ .

$$AC\ CMRR\ (dB) = 10\log(P_f/P_{f_s})$$

where:

$P_f$  is the power at frequency,  $f$ , in the ADC output.

$P_{f_s}$  is the power at frequency,  $f_s$ , in the ADC output.

**Channel to Channel Isolation**

Channel to channel isolation is a measure of the level of crosstalk between all input channels. It is measured by applying a full-scale sine wave signal, up to 160 kHz, to all unselected input channels and then determining the degree to which the signal attenuates in the selected channel with a 1 kHz sine wave signal applied.

**Phase Delay**

Phase delay is a measure of the absolute time delay between when an input is sampled by the converter and when the result associated with that sample is available to be read back from the ADC, including delay induced by the analog front end of the device.

**Phase Delay Drift**

Phase delay drift is the change in phase delay per unit temperature across the entire operating temperature of the device.

**Phase Delay Matching**

Phase delay matching is the maximum phase delay seen between any simultaneously sampled pair.

# THEORY OF OPERATION

## CONVERTER DETAILS

The AD7617 is a data acquisition system that employs a high speed, low power, charge redistribution, SAR ADC, and allows dual simultaneous sampling of 16 analog input channels. The analog inputs on the AD7617 can accept true bipolar input signals. Analog input range options include  $\pm 10$  V,  $\pm 5$  V, and  $\pm 2.5$  V. The AD7617 operates from a single 5 V supply.

The AD7617 contains input clamp protection, input signal scaling amplifiers, a first-order antialiasing filter, an on-chip reference, a reference buffer, a dual high speed ADC, a digital filter, a flexible sequencer, and high speed parallel and serial interfaces.

The AD7617 can operate in hardware or software mode by controlling the HW\_RNGSELx pins. In hardware mode, the AD7617 is configured by pin control. In software mode, the AD7617 is configured by the control registers accessed via the serial or parallel interface.

## ANALOG INPUT

### Analog Input Channel Selection

The AD7617 contains dual, simultaneous sampling, 14-bit ADCs. Each ADC has eight analog input channels for a total of 16 analog inputs. Additionally, the AD7617 has on-chip diagnostic channels to monitor the  $V_{CC}$  supply and an on-chip adjustable low dropout regulator. Channels can be selected for conversion by control of the CHSELx pins in hardware mode or via the channel register control in software mode. Software mode is required to sample the diagnostic channels. Channels can be selected dynamically or the AD7617 has an on-chip sequencer to allow the channels for conversion to be preprogrammed. In hardware mode, simultaneous sampling is limited to the corresponding A or B channel, that is, Channel V0A always samples with Channel V0B. In software mode, it is possible to select any A channel with any B channel for simultaneous sampling.

### Analog Input Ranges

The AD7617 can handle true bipolar, single-ended input voltages. The logic levels on the range select pins, HW\_RNGSEL0 and HW\_RNGSEL1, determine the analog input range of all analog input channels. If both range select pins are tied to a logic low, the analog input range is determined in software mode via the input range registers (see the Register Summary section for more details). In software mode, it is possible to configure an individual analog input range per channel.

Table 8. Analog Input Range Selection

Analog Input Range	HW_RNGSEL1	HW_RNGSEL0
Configured via the Input Range Registers	0	0
$\pm 2.5$ V	0	1
$\pm 5$ V	1	0
$\pm 10$ V	1	1

In hardware mode, a logic change on these pins has an immediate effect on the analog input range; however, there is typically a settling time of approximately 120  $\mu$ s in addition to the normal acquisition time requirement. The recommended practice is to hardwire the range select pins according to the desired input range for the system signals.

### Analog Input Impedance

The low drift analog input impedance of the AD7617 is 1 M $\Omega$ , a fixed input impedance that does not vary with the AD7617 sampling frequency. This high analog input impedance eliminates the need for a driver amplifier in front of the AD7617, allowing direct connection to the source or the sensor.

### Analog Input Clamp Protection

Figure 42 shows the analog input circuitry of the AD7617. Each analog input of the AD7617 contains clamp protection circuitry. Despite single +5 V supply operation, this analog input clamp protection allows an input overvoltage of between  $-20$  V and  $+20$  V.

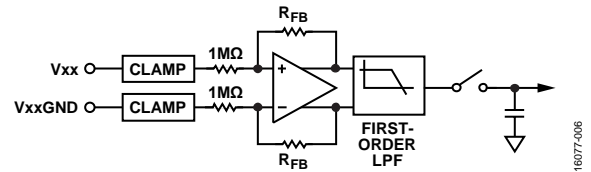

Figure 42. Analog Input Circuitry

Figure 43 shows the input clamp current vs. source voltage characteristic of the clamp circuit. For source voltages between  $-20$  V and  $+20$  V, no current flows in the clamp circuit. For input voltages that are greater than  $+20$  V and less than  $-20$  V, the AD7617 clamp circuitry turns on.

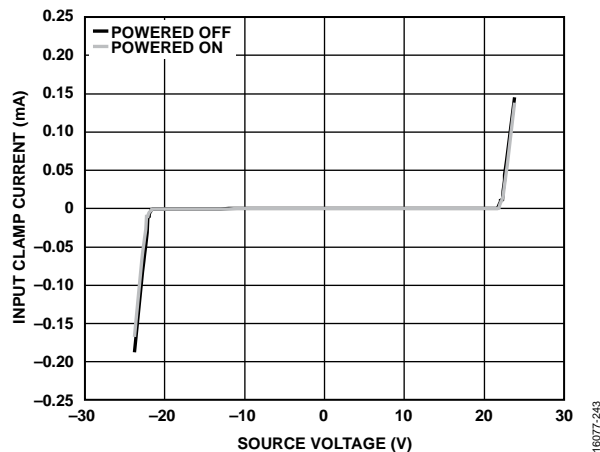

Figure 43. Input Protection Clamp Profile, Input Clamp Current vs. Source Voltage

Place a series resistor on the analog input channels to limit the current to  $\pm 10$  mA for input voltages greater than  $+20$  V and less than  $-20$  V. In an application where there is a series resistance on an analog input channel,  $V_{xA}$  or  $V_{xB}$ , a corresponding resistance is required on the analog input ground channel,  $V_{xAGND}$  or  $V_{xBGND}$  (see Figure 44).

If there is no corresponding resistor on the V<sub>xx</sub>AGND or V<sub>xx</sub>BGND channel, an offset error occurs on that channel. Use the input overvoltage clamp protection circuitry to protect the AD7617 against transient overvoltage events. It is not recommended to leave the AD7617 in a condition where the clamp protection circuitry is active in normal or power-down conditions for extended periods.

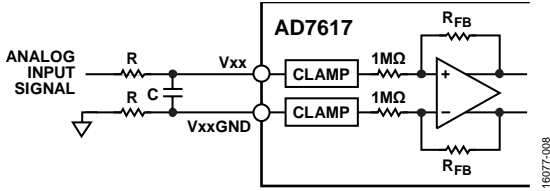

Figure 44. Input Resistance Matching on the Analog Input

**Analog Input Antialiasing Filter**

An analog antialiasing filter (a first-order Butterworth) is also provided on the AD7617. Figure 45 and Figure 46 show the frequency and phase response, respectively, of the analog antialiasing filter. The typical corner frequency in the ±10 V range is 39 kHz, and 33 kHz in the ±5 V range.

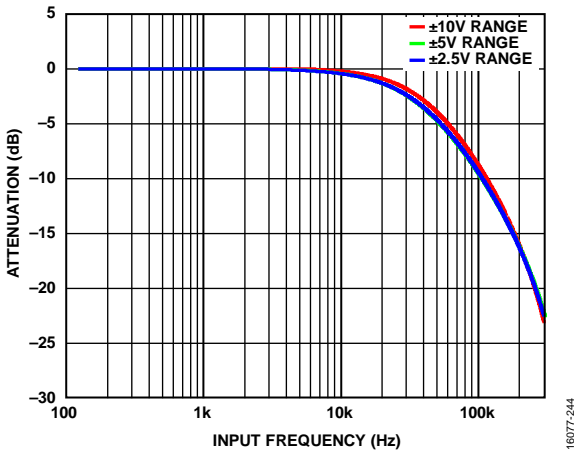

Figure 45. Analog Antialiasing Filter Frequency Response

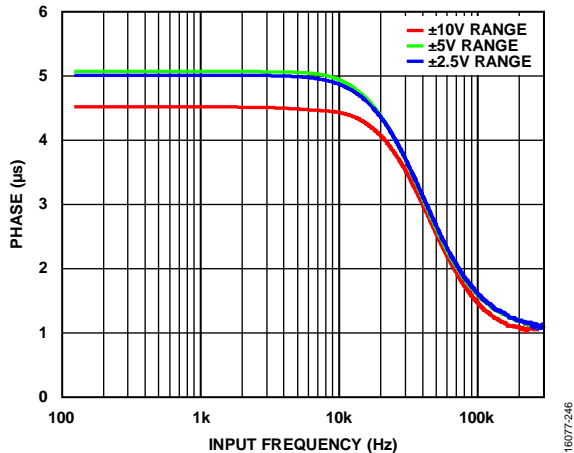
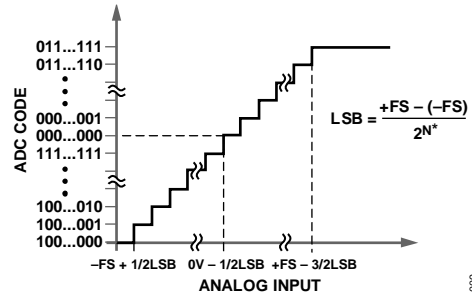

Figure 46. Analog Antialiasing Filter Phase Response

**ADC TRANSFER FUNCTION**

The output coding of the AD7617 is twos complement. The code transitions occur midway between successive integer LSB values, that is, 1/2 LSB and 3/2 LSB. The LSB size is full-scale range ÷ 16,384 for the AD7617. The ideal transfer characteristics for the AD7617 are shown in Figure 47 and Figure 9. The LSB size is dependent on the analog input range selected.



\*WHERE N IS THE NUMBER OF BITS OF THE CONVERTER

Figure 47. Transfer Characteristics

Table 9.

Range	+FS	Midscale	-FS	LSB
±10 V	+10 V	0 V	-10 V	+1220 µV
±5 V	+5 V	0 V	-5 V	+610 µV
±2.5 V	+2.5 V	0 V	-2.5 V	+305 µV

**INTERNAL/EXTERNAL REFERENCE**

The AD7617 can operate with either an internal or external reference. The device contains an on-chip 2.5 V band gap reference. The REFINOUT pin allows access to the 2.5 V reference that generates the on-chip 4.096 V reference internally, or it allows an external reference of 2.5 V to be applied to the AD7617. An externally applied reference of 2.5 V is also amplified to 4.096 V using the internal buffer. This 4.096 V buffered reference is the reference used by the SAR ADC.

The REFSEL pin is a logic input pin that allows the user to select between the internal reference and an external reference. If this pin is set to logic high, the internal reference is selected and enabled. If this pin is set to logic low, the internal reference is disabled, and an external reference voltage must be applied to the REFINOUT pin.

The internal reference buffer is always enabled. After a full reset, the AD7617 operates in the reference mode selected by the REFSEL pin. Decoupling is required on the REFINOUT pin for both the internal and external reference options. A 100 nF, X7R ceramic capacitor is required on the REFINOUT pin to REFINOUTGND.



The AD7617 contains a reference buffer configured to amplify the reference voltage to ~4.096 V. A 10  $\mu$ F, X5R ceramic capacitor is required between REFCAP and REFGND. The reference voltage available at the REFINOUT pin is 2.5 V. When the AD7617 is configured in external reference mode, the REFINOUT pin is a high input impedance pin.

If the internal reference is applied elsewhere within the system, it must first be buffered externally.

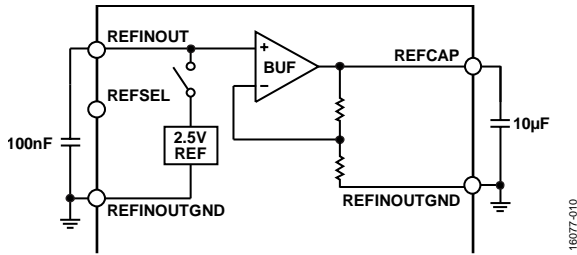

Figure 48. Reference Circuitry

**SHUTDOWN MODE**

The AD7617 enters shutdown mode by keeping the RESET pin low for greater than 1.2  $\mu$ s. When the RESET pin is set from low to high, the device exits shutdown mode and enters normal mode.

When the AD7617 is placed in shutdown mode, the current consumption is typically 48  $\mu$ A, and the power-up time to perform a write to the device is approximately 240  $\mu$ s. Power-up time to perform a conversion is 15 ms. In shutdown mode, all circuitry is powered down and all registers are cleared and reset to their default values.

**DIGITAL FILTER**

The AD7617 contains an optional digital first-order sinc filter for use in applications where slower throughput rates are in use or where higher SNR or dynamic range is desirable.

The OSR of the digital filter is controlled in hardware using the oversampling pins, OS2 to OS0 (OSx), or in software via the OS bits within the configuration register.

In software mode, oversampling is enabled for all channels after the OS bits are set in the configuration register. In hardware mode, the OSx signals at the time a full reset is released determine the OSR used.

Table 10 provides the oversampling bit decoding to select the different oversample rates. In addition to the oversampling function, the output result is decimated to 14-bit resolution.

If the OSx pins/OS bits are set to select an OS ratio of eight, the next CONVST rising edge takes the first sample for the selected channel, and the remaining seven samples for that channel are taken with an internally generated sampling signal. These samples are then averaged to yield an improvement in SNR performance. As the OS ratio increases, the -3 dB frequency is reduced, and the allowed sampling frequency is also reduced. The conversion time extends as the oversampling rate is increased, and the BUSY signal scales with oversampling rates. Acquisition and conversion time increase linearly with oversampling ratio.

If oversampling is enabled with the sequencer, or in burst mode, the extra samples are gathered for a given channel before the sequencer moves on to the next channel.

Table 10 shows the typical SNR performance of the device for each permissible oversampling ratio. The input tone used was a 1 kHz sine wave for the three input ranges of the device. A plot of SNR vs. OSR is shown in Figure 49.

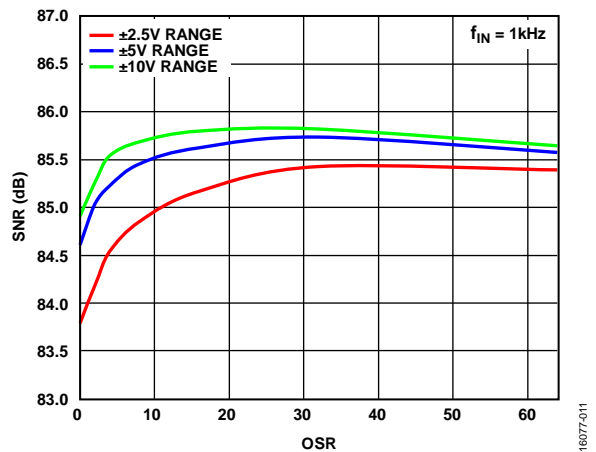

Figure 49. Typical SNR vs. OSR for all Analog Input Ranges

Table 10. Oversampling Bit Decoding

OSx Pins/OS Bits	OSR	Typical SNR (dB)			-3 dB Bandwidth (kHz)
		±2.5 V Range	±5 V Range	±10 V Range	All Ranges
000	No oversampling	83.8	84.6	84.9	37
001	2	84.2	85.0	85.3	36.5
010	4	84.5	85.2	85.5	35
011	8	84.9	85.5	85.7	30.5
100	16	85.2	85.6	85.8	22
101	32	85.4	85.7	85.8	13.2
110	64	85.4	85.6	85.6	7.2
111	128	84.7	85.1	85.2	3.6

## APPLICATIONS INFORMATION

### FUNCTIONALITY OVERVIEW

The AD7617 has two main modes of operation: hardware mode and software mode. Additionally, the communications interface for hardware or software mode can be serial or parallel. Depending on the mode of operation and interface chosen, certain functionality may not be available. Full functionality is available in both software serial and software parallel mode with restricted functionality in hardware serial mode and hardware parallel mode. Table 11 shows the functionality available in the different modes of operation.

### POWER SUPPLIES

The AD7617 has two independent power supplies,  $V_{CC}$  and  $V_{DRIVE}$ , that supply the analog circuitry and digital interface, respectively. Decouple both the  $V_{CC}$  supply and the  $V_{DRIVE}$  supply with a 10  $\mu\text{F}$  capacitor in parallel with a 100 nF capacitor.

Additionally, these supplies are regulated by two internal LDO regulators. The analog LDO (ALDO) typically supplies 1.87 V. Decouple the ALDO with a 10  $\mu\text{F}$  capacitor between the

REGCAP and REGGND pins. The digital LDO (DLDO) typically supplies 1.89 V. Decouple the DLDO with a 10  $\mu\text{F}$  capacitor between the REGCAPD and REGGND pins.

The AD7617 is robust to power supply sequencing. The recommended sequence is to power up  $V_{DRIVE}$  first, followed by  $V_{CC}$ . Hold RESET low until both supplies are stabilized.

### TYPICAL CONNECTIONS

Figure 50 shows the typical connections required for correct operation of the AD7617. Decouple the  $V_{CC}$  and  $V_{DRIVE}$  supplies as shown in Figure 50. Place the smaller, 0.1  $\mu\text{F}$  capacitor as close to the supply pin as possible, with the larger 10  $\mu\text{F}$  bulk capacitor in parallel. Decouple the reference and LDO regulators as shown in Figure 50 and as described in Table 7.

The analog input pins require a matched resistance, R, on both the  $V_{xA}$  and  $V_{xAGND}$  (similarly,  $V_{xB}$  and  $V_{xBGND}$ ) inputs to avoid a gain error on the analog input channels caused by an impedance mismatch.

**Table 11. Functionality Matrix**

Functionality	Operation Mode <sup>1</sup>			
	Software Mode, HW_RNGSELx = 00		Hardware Mode, HW_RNGSELx $\neq$ 00	
	Serial, SER/PAR = 1	Parallel, SER/PAR = 0	Serial, SER/PAR = 1	Parallel, SER/PAR = 0
Internal/External Reference	Yes	Yes	Yes	Yes
Selectable Analog Input Ranges				
Individual Channel Configuration	Yes	Yes	No	No
Common Channel Configuration	No	No	Yes	Yes
Sequential Sequencer	Yes	Yes	Yes	Yes
Fully Configurable Sequencer	Yes	Yes	No	No
Burst Mode	Yes	Yes	Yes	Yes
On-Chip Oversampling	Yes	Yes	Yes	No
CRC	Yes	Yes	Yes	No
Diagnostic Channel Conversion	Yes	Yes	No	No
Hardware Reset	Yes	Yes	Yes	Yes
Serial 1-Wire Mode	Yes	No	Yes	No
Serial 2-Wire Mode	Yes	No	Yes	No
Register Access	Yes	Yes	No	No

<sup>1</sup> Yes means available; no means not available.

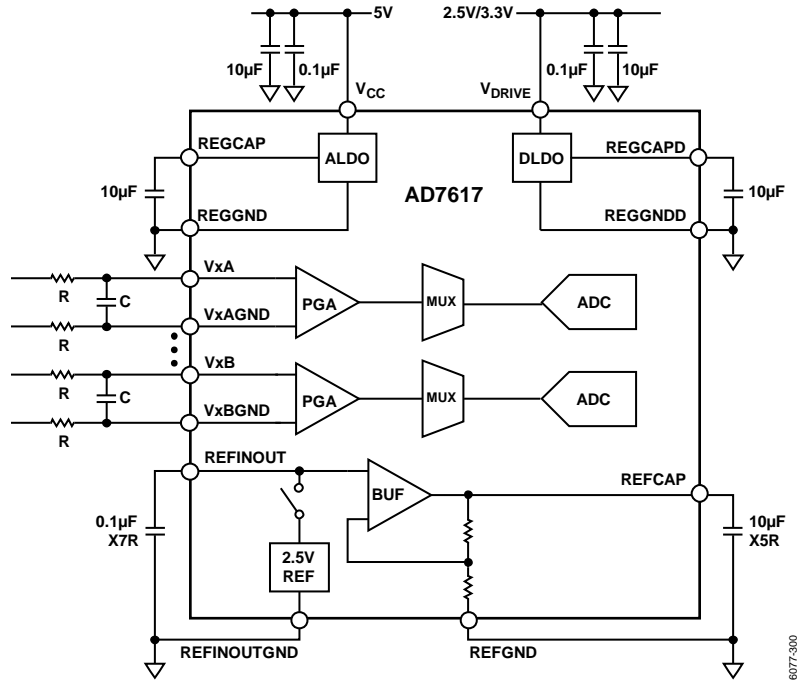

Figure 50. Typical External Connections

16877-300

## DEVICE CONFIGURATION

### OPERATIONAL MODE

The mode of operation, hardware mode or software mode, is configured when the AD7617 is released from full reset. The logic level of the HW\_RNGSELx pins when the RESET pin transitions from low to high determines the operational mode. The HW\_RNGSELx pins are dual function. If HW\_RNGSELx = 00, the AD7617 enters software mode. Any other combination of the HW\_RNGSELx configures the AD7617 in hardware mode and the analog input range is configured as per Table 8. After software mode is configured, the logic level of the HW\_RNGSELx signals is ignored. After an operational mode is configured, a full reset via the RESET pin is required to exit the operational mode and to set up an alternative mode. If hardware mode is selected, all further device configuration is via pin control. Access to the on-chip registers is prohibited in hardware mode. In software mode, the interface and reference configuration must be configured via pin control; however, all further device configuration is via register access only.

### INTERNAL/EXTERNAL REFERENCE

The internal reference is enabled or disabled when the AD7617 is released from a full reset. The logic level of the REFSEL signal when the RESET pin transitions from low to high configures the reference. After the reference is configured, changes to the logic level of the REFSEL signal are ignored. If the REFSEL signal is set to Logic 1, the internal reference is enabled. If REFSEL is set to Logic 0, the internal reference is disabled and an external reference must be supplied to the REFINOUT pin for correct operation of the AD7617. A full reset via the RESET pin is required to exit the operational mode and set up an alternative mode.

Connect a 100 nF capacitor between the REFINOUT and REFINOUTGND pins. If using an external reference, place a 10 k $\Omega$  band limiting resistor in series between the reference and the REFINOUT pin of the AD7617.

### DIGITAL INTERFACE

The digital interface selection, parallel or serial, is configured when the AD7617 is released from a full reset. The logic level of the SER/PAR signal when the RESET pin transitions from low to high configures the interface.

If the SER/PAR signal is set to 0, the parallel interface is enabled. If the SER/PAR signal is set to 1, the serial interface is selected. Additionally, if the serial interface is selected, the SER1W signal is monitored when the RESET pin is released to determine if serial 1-wire or 2-wire mode is selected. After the interface is configured, changes to the logic level of the SER/PAR signal or the SER1W signal (when the serial interface is enabled) are ignored. A full reset via the RESET pin is required to exit the operation mode and set up an alternative mode.

### HARDWARE MODE

If hardware mode is selected, the available functionality is restricted and all functionality is configured via pin control. The logic level of the following signals is checked after a full reset to configure the functionality of the AD7617: CRC, BURST, SEQEN, and OSx. Table 12 provides a summary of the signals that are latched by the device on the release of a full reset, depending on the mode of operation chosen. After the device is configured, a full reset via the RESET pin is required to exit the configuration and set up an alternative configuration. Functionality availability is restricted depending on the interface type selected. See Table 11 for a full list of the functionality available in hardware parallel or serial mode.

The CHSELx pins are queried at reset to determine the initial analog input channel pair to acquire for conversion or to configure the initial settings for the sequencer. The channel pair selected for conversion or the hardware sequencer can be reconfigured during normal operation by setting and maintaining the CHSELx signal level before the CONVST rising edge until the BUSY falling edge.

The HW\_RNGSELx signals control the analog input range for all 16 analog input channels. A logic change on these pins has an immediate effect on the analog input range; however, the typical settling time is approximately 120  $\mu$ s, in addition to the normal acquisition time requirement. The recommended practice is to hardwire the range select pins according to the desired input range for the system signals.

Access to the on-chip registers is prohibited in hardware mode.

Table 12. Summary of Latched Hardware Signals<sup>1</sup>

Signal	Latched at Full Reset		Read at Reset		Read During Busy		Edge Driven	
	HW Mode	SW Mode	HW Mode	SW Mode	HW Mode	SW Mode	HW Mode	SW Mode
REFSEL	Yes	Yes						
SEQEN	Yes	No						
HW_RNGSELx (Range Change)			Yes	Yes			Yes	No
HW_RNGSELx (Hardware (HW) or Software (SW) Mode)	Yes	Yes						
SER/PAR	Yes	Yes						
CRCEN	Yes	No						
OSx	Yes	No						
BURST	Yes	No						
CHSELx			Yes	No	Yes	No		
SER1W	Yes	Yes						

<sup>1</sup> Blank cells in Table 12 mean not applicable.

## SOFTWARE MODE

If software mode is selected and the reference and interface type is configured, all other configuration settings in the AD7617 are controlled via the on-chip registers. All functionality of the AD7617 is available when software mode is selected. Table 12 provides a summary of the signals that are latched by the device on the release of a full reset, depending on the mode of operation chosen.

## RESET FUNCTIONALITY

The AD7617 has two reset modes: full or partial. The reset mode selected is dependent on the length of the reset low pulse. A partial reset requires the  $\overline{\text{RESET}}$  pin to be held low between 40 ns and 500 ns. After 50 ns from release of  $\overline{\text{RESET}}$ , the device is fully functional and a conversion can initiate. A full reset requires the  $\overline{\text{RESET}}$  pin to be held low for a minimum of 1.2  $\mu\text{s}$ . After 15 ms from release of  $\overline{\text{RESET}}$ , the devices is completely reconfigured and a conversion can initiate.

A partial reset reinitializes the following modules:

- Sequencer
- Digital filter
- SPI
- Both SAR ADCs

The current conversion result is discarded on completion of a partial reset. The partial reset does not affect the register values programmed in software mode or the latches that store the user configuration in both hardware and software modes. A dummy conversion is required in software mode after a partial reset.

A full reset returns the device to its default power-on state. The following features are configured when the AD7617 is released from full reset:

- Hardware mode or software mode
- Internal/external reference
- Interface type

On power-up, the  $\overline{\text{RESET}}$  signal can be released as soon as both the  $V_{CC}$  and  $V_{DRIVE}$  supplies are stable. The logic level of the HW\_RNGSELx, REFSEL, SER/PAR and DB4/SER1W pins when the  $\overline{\text{RESET}}$  pin is released after a full reset determines the configuration.

If hardware mode is selected, the functionality determined by the CRC, BURSTEN, SEQEN, and OSx signals is also latched when the  $\overline{\text{RESET}}$  pin transitions from low to high in full reset mode. After the functionality is configured, changes to these signals are ignored. In hardware mode, the analog input range (HW\_RNGSELx signals) can be configured during either a full or partial reset or during normal operation; however, hardware/software mode selection requires a full reset to reconfigure while this setting is latched.

In hardware mode, the CHSELx and HW\_RNGSELx pins are queried at release from both a full and a partial reset to perform the following actions:

- Determine the initial analog input channel pair to acquire for conversion.
- Configure the initial settings for the sequencer.
- Select the analog input voltage range.

The CHSELx and HW\_RNGSELx signals are not latched. The channel pair selected for conversion, or the hardware sequencer, can be reconfigured during normal operation by setting and maintaining the CHSELx signal level before the CONVST rising edge, and ensuring the signal level remains constant until after BUSY transitions low again. See the Channel Selection section for further details.

In software mode, all additional functionality is configured by controlling the on-chip registers.

**PIN FUNCTION OVERVIEW**

There are several dual function pins on the AD7617. Their functionality is dependent on the mode of operation selected by the HW\_RNGSELx pins.

Table 13 outlines the pin functionality in the different modes of operation and interface modes.

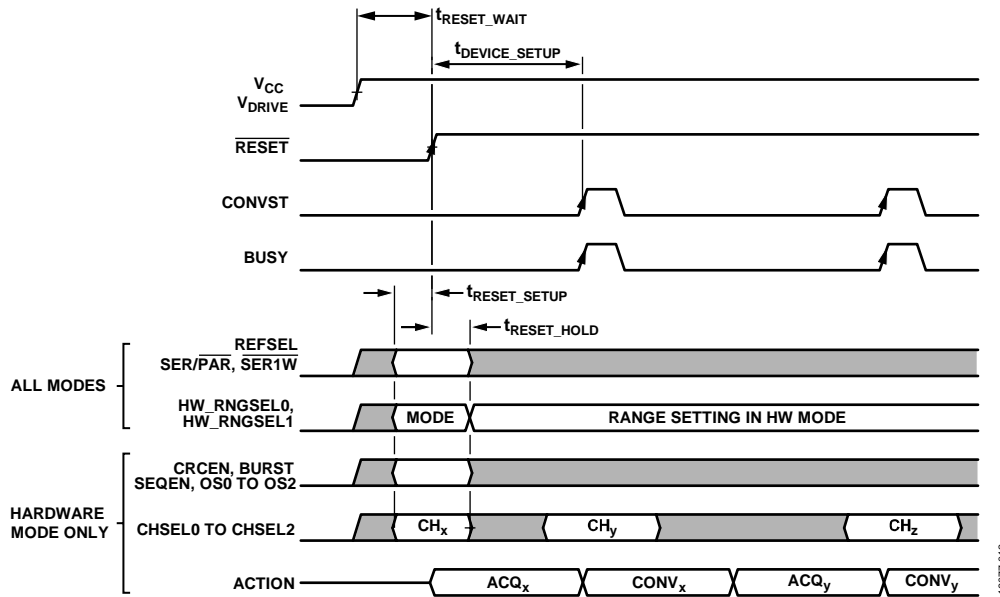

Figure 51. AD7617 Configuration at Reset

Table 13. Pin Functionality Overview

Pins	Operation Mode			
	Software, HW_RNGSELx = 00		Hardware, HW_RNGSELx ≠ 00	
	Serial, SER/PAR = 1	Parallel, SER/PAR = 0	Serial, SER/PAR = 1	Parallel, SER/PAR = 0
CHSELx	No function, connect to DGND	No function, connect to DGND	CHSELx	CHSELx
SCLK/RD	SCLK	RD	SCLK	RD
WR/BURST	Connect to DGND	WR	BURST	BURST
DB15/OS0 to DB13/OS2	Connect to DGND	DB15 to DB13	OSx	DB15 to DB13
DB12/SDOA	SDOA	DB12	SDOA	DB12
DB11/SDOB	SDOB, leave floating for serial 1-wire mode	DB11	SDOB	DB11
DB10/SDI	SDI	DB10	Connect to DGND	DB10
DB9 to DB6, DB3 to DB2	Connect to DGND	DB9 to DB6, DB3 to DB2	Connect to DGND	DB9 to DB6, DB3 to DB2
DB5/CRCEN	Connect to DGND	DB5	CRCEN	DB5
DB4/SER1W	SER1W	DB4	SER1W	DB4
DB1 to DB0	Connect to DGND	DB1 to DB0	Connect to DGND	Float or pull to DGND via a 10 kΩ resistor
HW_RNGSELx	HW_RNGSELx, connect to DGND	HW_RNGSELx, connect to DGND	HW_RNGSELx, configure analog input range	HW_RNGSELx, configure analog input range
SEQEN	No function, connect to DGND	No function, connect to DGND	SEQEN	SEQEN
REFSEL	REFSEL	REFSEL	REFSEL	REFSEL

# DIGITAL INTERFACE

## CHANNEL SELECTION

### Hardware Mode

The logic level of the CHSELx signals determine the channel pair for conversion; see Table 14 for signal decoding information. The CHSELx signals at the time that either full or partial reset is released determine the initial channel pair to sample. After a reset, the logic levels of the CHSELx signals are examined during the BUSY high period to set the channel pair for the next conversion. The CHSELx signal level must be set before CONVST goes from low to high and be maintained until BUSY goes from high to low to indicate a conversion is complete. See Figure 52 for further details.

### Software Mode

In software mode, the channels for conversion are selected by control of the channel register. On power-up or after a reset, the default channels selected for conversion are Channel V0A and Channel V0B (see Figure 53).

Table 14. CHSELx Pin Decoding

Channel Selection Input Pin			Analog Input Channels for Conversion
CHSEL0	CHSEL1	CHSEL2	
0	0	0	V0A, V0B
0	0	1	V1A, V1B
0	1	0	V2A, V2B
0	1	1	V3A, V3B
1	0	0	V4A, V4B
1	0	1	V5A, V5B
1	1	0	V6A, V6B
1	1	1	V7A, V7B

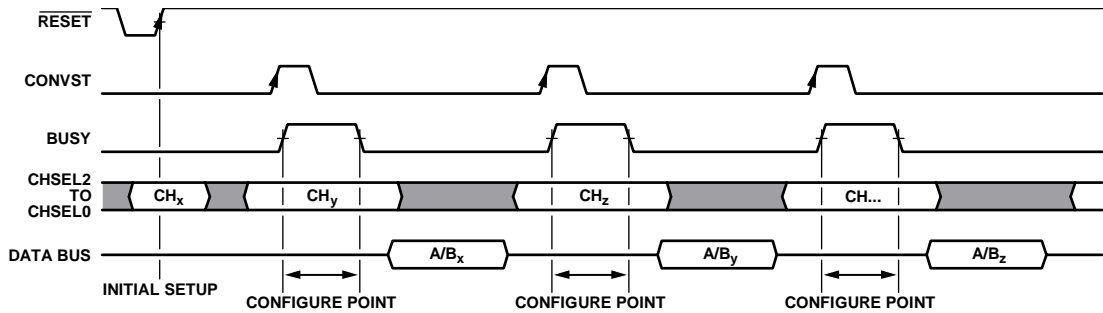

Figure 52. Hardware Mode Channel Conversion Setting

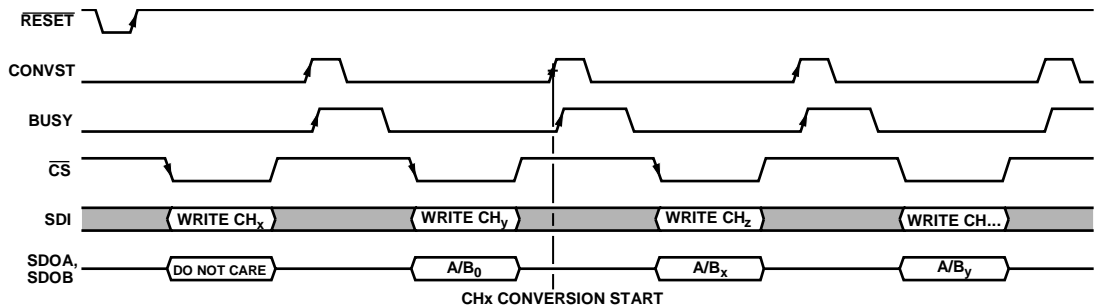

Figure 53. Software Serial Mode Channel Conversion Setting

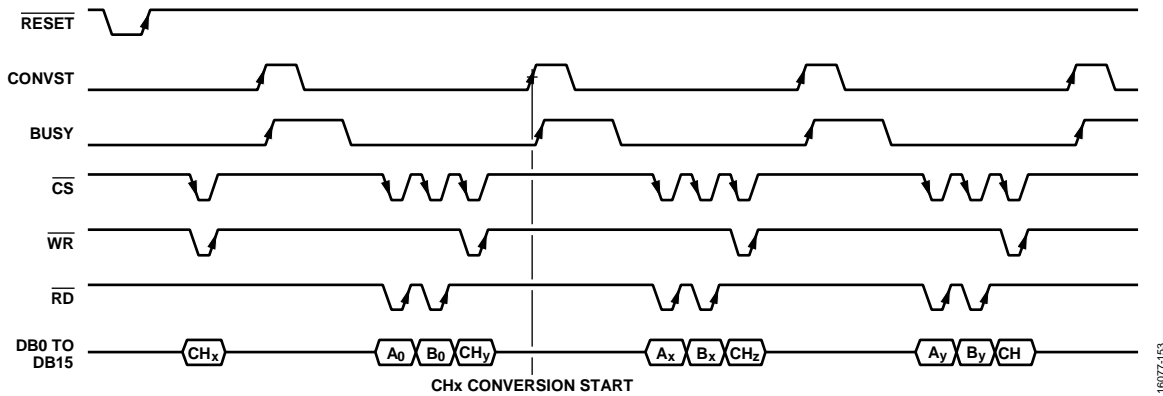

Figure 54. Software Parallel Mode Channel Conversion Setting

## PARALLEL INTERFACE

The parallel interface reads the conversion results, and configures and reads back the on-chip registers. Data can be read from the AD7617 via the parallel data bus with standard  $\overline{\text{CS}}$ ,  $\overline{\text{RD}}$ , and  $\overline{\text{WR}}$  signals. To read the data over the parallel bus, tie the SER/PAR pin low.

### Reading Conversion Results

The  $\text{CONVST}$  signal initiates the conversion process. A low to high transition on the  $\text{CONVST}$  signal initiates a conversion of the selected inputs. The  $\text{BUSY}$  signal goes high to indicate a conversion is in progress. When the  $\text{BUSY}$  signal transitions from high to low to indicate that a conversion is complete, it is possible to read back conversion results on the parallel interface.

Data can be read from the AD7617 via the parallel data bus with standard  $\overline{\text{CS}}$  and  $\overline{\text{RD}}$  signals. The  $\overline{\text{CS}}$  and  $\overline{\text{RD}}$  input signals are internally gated to enable the conversion result onto the data bus. The data lines, DB15 to DB2, leave their high impedance state when both  $\overline{\text{CS}}$  and  $\overline{\text{RD}}$  are logic low. DB15 is the MSB of the conversion result and DB2 is the LSB of the 14-bit conversion result. The data lines DB1 and DB0 are only used for register write/read operations or for reading the CRC result.

The rising edge of the  $\overline{\text{CS}}$  input signal three-states the bus, and the falling edge of the  $\overline{\text{CS}}$  input signal takes the bus out of the high impedance state.  $\overline{\text{CS}}$  is the control signal that enables the data lines; it is the function that allows multiple AD7617 devices to share the same parallel data bus.

The number of required read operations depends on the device configuration. A minimum of two reads are required to read the conversion result for the simultaneously sampled A and B channels. If additional functions such as CRC, status, and burst mode are enabled, the number of required readbacks increases accordingly.

The  $\overline{\text{RD}}$  pin reads data from the output conversion results register. Applying a sequence of  $\overline{\text{RD}}$  pulses to the  $\overline{\text{RD}}$  pin of the AD7617 clocks the conversion results out from each channel onto the parallel bus, DB15 to DB2.

The first  $\overline{\text{RD}}$  falling edge after  $\text{BUSY}$  goes low clocks out the conversion result from Channel  $\text{A}_x$ . The next  $\overline{\text{RD}}$  falling edge updates the bus with the Channel  $\text{B}_x$  conversion result.

### Writing Register Data

In software mode, all the read/write registers in the AD7617 may be written to over the parallel interface. A register write command is performed by a single 16-bit parallel access via the parallel bus (DB15 to DB0),  $\overline{\text{CS}}$ , and  $\overline{\text{WR}}$  signals. Provide data written to the AD7617 on the DB15 to DB0 inputs, with DB0 being the LSB of the data-word. The format for a write command is shown in Figure 55. Bit D15 must be set to 1 to select a write command. Bits[D14:D9] contain the register address. The subsequent nine bits (Bits[D8:D0]) contain the data to be written to the selected register. See the Register Summary section for the complete list of register addresses. Data is latched into the device on the rising edge of  $\overline{\text{WR}}$ .

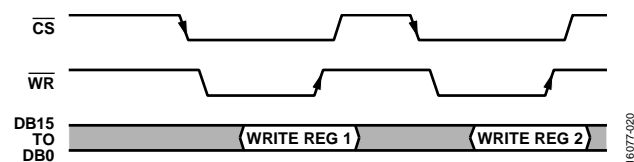

Figure 55. Parallel Interface Register Write

### Reading Register Data

All the registers in the device can be read over the parallel interface. A register read is performed by first writing the address of the register to be read to the AD7617. The format for a register read command is shown in Figure 57. Bit D15 must be set to 0 to select a read command. Bits[D14:D9] contain the register address. The subsequent nine bits (Bits[D8:D0]) are ignored. The read command is latched into the AD7617 on the rising edge of  $\overline{\text{WR}}$ . This latch transfers the relevant register data to the output register. The register data can then be read on the DB15 to DB0 pins by using a standard read command. See Figure 57 for additional information.



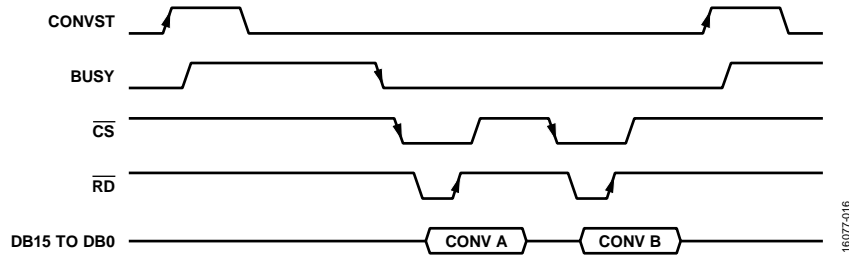

Figure 56. Parallel Interface Conversion Readback

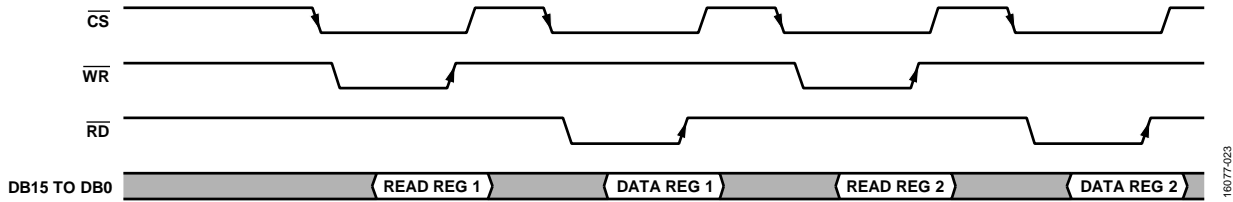

Figure 57. Parallel Interface Register Read

**SERIAL INTERFACE**

To interface to the AD7617 over the SPI, the SER/PAR pin must be tied high. The CS and SCLK signals transfer data from the AD7617. The AD7617 has two serial data output pins, SDOA and SDOB. Data is read back from the AD7617 using serial 1-wire or serial 2-wire mode.

In serial 2-wire mode for the AD7617, conversion results from Channel V0A to Channel V7A appear on SDOA, and conversion results from Channel V0B to Channel V7B appear on SDOB. In serial 1-wire mode, conversion results from Channel V0B to Channel V7B are interlaced with conversion results from Channel V0A to Channel V7A. To achieve the maximum throughput, it is required to use 2-wire mode.

To read back data over both SDOA and SDOB, the SER1W pin must be tied high. If data is read back over SDOA only, the tie SER1W pin low. Serial 1-wire or 2-wire mode is configured when the AD7617 is released from full reset.

**Reading Conversion Results**

The CONVST signal initiates the conversion process. A low to high transition on the CONVST signal initiates a conversion of the selected inputs. The BUSY signal goes high to indicate a conversion is in progress. When the BUSY signal transitions from high to low to indicate that a conversion is complete, it is possible to read back conversion results on the serial interface.

The CS falling edge takes the data output lines, SDOA and SDOB, out of three-state and clocks out the MSB of the conversion result. The rising edge of SCLK clocks all subsequent data bits onto the serial data outputs, SDOA and SDOB. Figure 58 shows a read of two simultaneous conversion results using two SDOx lines on the AD7617. If the status register is appended to the conversion results or operating in sequencer burst mode where multiples of 16 SCLK transfers access data from the AD7617, hold CS low to frame the entire data.

Data can also be clocked out using just one SDOx line, in which case, use SDOA to access all conversion data. For the AD7617 to access both Channel VxA and Channel VxB conversion results on one SDOx line, a total of 32 SCLK cycles is required. Frame these 32 SCLK cycles using one CS signal, or individually frame each group of 16 SCLK cycles using the CS signal. The disadvantage of using just one SDOx line is that the throughput rate is reduced.

In serial 2-wire, 16 SCLK cycles are required to read a conversion result. The first SCLK cycle reads the MSB of the conversion results. The 14<sup>th</sup> SCLK cycle reads the LSB. The last two SCLK cycles clock out zeros, as shown in Figure 58. In serial 1-wire, 32 SCLK cycles (or 2x 16 SCLK cycles) are required to read a conversion result. The first 16 SCLK cycles read the 14-bit Channel VxA result, followed by two zeros. The next 16 SCLK cycles read the 14-bit Channel VxB result, followed by two zeros, as shown in Figure 59. With CRC enabled, all 16 SCLK cycles read the status register. Refer to the CRC section for further information.

Leave the unused SDOB line unconnected in serial 1-wire mode. If using SDOA as a single serial data output line, the channel results are output in the following order: VxA and VxB. Figure 59 shows a 1-wire, serial readback operation.

The speed at which the data can be read back in serial interface mode is dependent on SPI frequency, V<sub>DRIVE</sub> supply, and the capacitance of the load on the SDO line, C<sub>LOAD</sub>. Table 15 shows a summary of the maximum speed achievable for various conditions.

**Table 15. SPI Frequency vs. Load Capacitance and V<sub>DRIVE</sub>**

V <sub>DRIVE</sub> (V)	C <sub>LOAD</sub> (pF)	SPI Frequency (MHz)
2.3 to 3	20	40
3 to 3.6	30	50

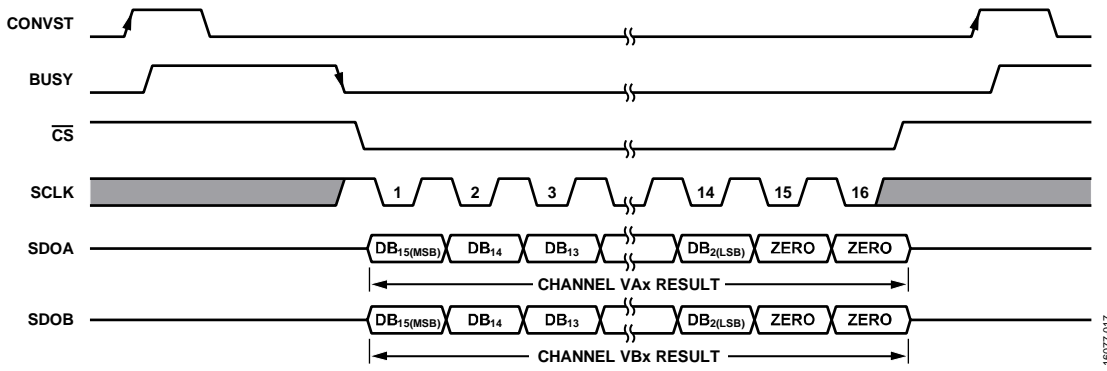

Figure 58. Serial Interface, 2-Wire Mode Reading Conversion Result

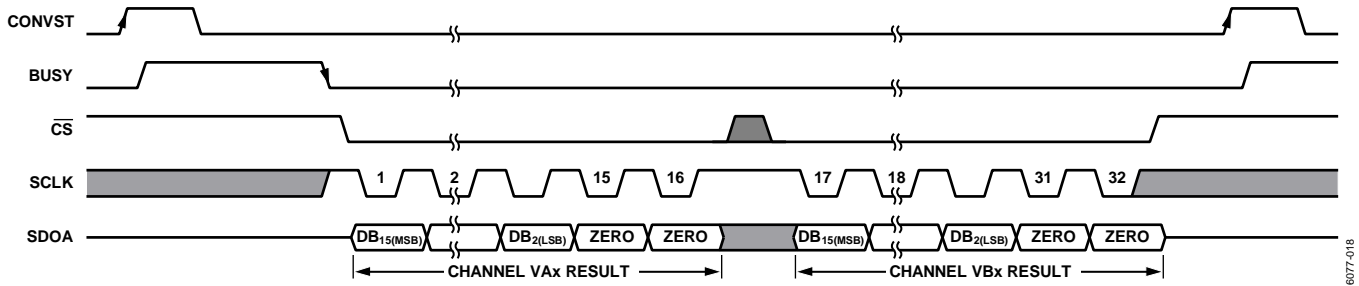

Figure 59. Serial Interface, 1-Wire Mode Reading Conversion Result

**Writing Register Data**

All the read/write registers in the AD7617 can be written to over the serial interface. A register write command is performed by a single 16-bit SPI access. The format for a write command is shown in Table 16. Bit D15 must be set to 1 to select a write command. Bits[D14:D9] contain the register address. The subsequent nine bits (Bits[D8:D0]) contain the data to be written to the selected register. Figure 60 shows a typical serial interface register write command.

**Reading Register Data**

All the registers in the device can be read over the serial interface. A register read is performed by issuing a register read command followed by an additional SPI command that can be either a valid command or no operation (NOP). The format for a read command is shown in Table 17. Bit D15 must be set to 0 to select a read command. Bits[D14:D9] contain the register address. The subsequent nine bits (Bits[D8:D0]) are ignored. See the Register Summary section for the complete list of register addresses. Figure 61 shows a typical serial interface register read command.

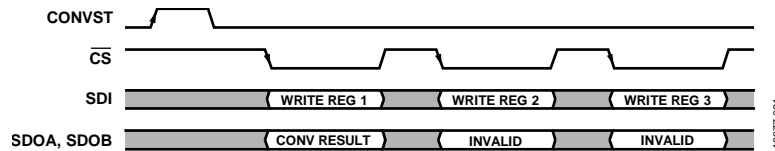

Figure 60. Serial Interface Register Write

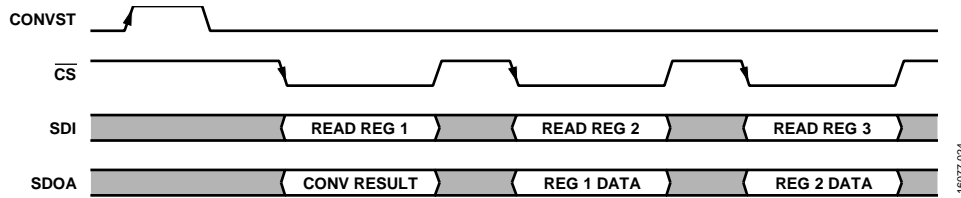

Figure 61. Serial Interface Register Read

**Table 16. Write Command Message Configuration**

MSB															LSB
D15	D14	D13	D12	D11	D10	D9	D8	D7	D6	D5	D4	D3	D2	D1	D0
W/R	REGADDR[5:0]						Data[8:0]								
1	Register address						Data to write								

**Table 17. Read Command Message Configuration**

MSB															LSB
D15	D14	D13	D12	D11	D10	D9	D8	D7	D6	D5	D4	D3	D2	D1	D0
W/R	REGADDR[5:0]						Data[8:0]								
0	Register address						Do not care								

## SEQUENCER

The AD7617 features a highly configurable on-chip sequencer. The functionality and configuration of the sequencer is dependent on the mode of operation of the AD7617.

In hardware mode, the sequencer is sequential only. The sequencer always starts converting at Channel V0A and Channel V0B and converts each subsequent channel up to the configured end channel.

In software mode, the sequencer has additional functionality and configurability. The sequencer stack has 32 uniquely configurable sequence steps, allowing any channel order to be programmed. Additionally, any Channel VxA input can be paired with any Channel VxB input or diagnostic channel.

The sequencer can be operated with or without the burst function enabled. With the burst function enabled, only one CONVST pulse is required to convert every channel in a sequence. With burst mode disabled, one CONVST pulse is required for every conversion step in the sequence. See the Burst Sequencer section for additional details on operating in burst mode.

### HARDWARE MODE SEQUENCER

In hardware mode, the sequencer is controlled by the SEQEN pin and the CHSELx pins. The sequencer is enabled or disabled when the AD7617 is released from full reset. The logic level of the SEQEN pin when the RESET pin is released determines whether the sequencer is enabled or disabled (see Table 18 for settings). After the RESET pin is released, the function is fixed and a full reset via the RESET pin is required to exit the function and set up an alternative configuration.

**Table 18. Hardware Mode Sequencer Configuration**

SEQEN	Interface Mode
0	Sequencer disabled
1	Sequencer enabled

When the sequencer is enabled, the logic levels of the CHSELx pins determine the channels selected for conversion in the sequence. The CHSELx pins at the time RESET is released determine the initial settings for the channels to convert in the sequence. To reconfigure the channels selected for conversion thereafter, set the CHSELx pins to the required setting for the duration of the final BUSY pulse before the current conversion sequence is complete. See Figure 62 for further details.

**Table 19. CHSELx Pin Decoding Sequencer**

Channel Selection Input Pin			Analog Input Channels for Sequential Conversion
CHSEL0	CHSEL1	CHSEL2	
0	0	0	V0x only
0	0	1	V0x to V1x
0	1	0	V0x to V2x
0	1	1	V0x to V3x
1	0	0	V0x to V4x
1	0	1	V0x to V5x
1	1	0	V0x to V6x
1	1	1	V0x to V7x

### SOFTWARE MODE SEQUENCER

In software mode, the AD7617 contains a 32-layer fully configurable sequencer stack. Control of the sequencer is achieved by programming the configuration register and sequencer stack registers via the parallel or serial interface.

Each stack step can be individually programmed to pair any input from Channel VxA to any input from Channel VxB, or any diagnostic channel can be selected for conversion. The sequencer depth can be set to any length from 1 to 32 layers. The sequencer depth is controlled via the SSRENx bit. Set the SSRENx bit in the sequencer stack register corresponding to the last step required. The channels to convert are selected by programming the ASELx and BSELx bits in each sequence stack register for the depth required.

The sequencer is activated by setting the SEQEN bit in the configuration register to 1.

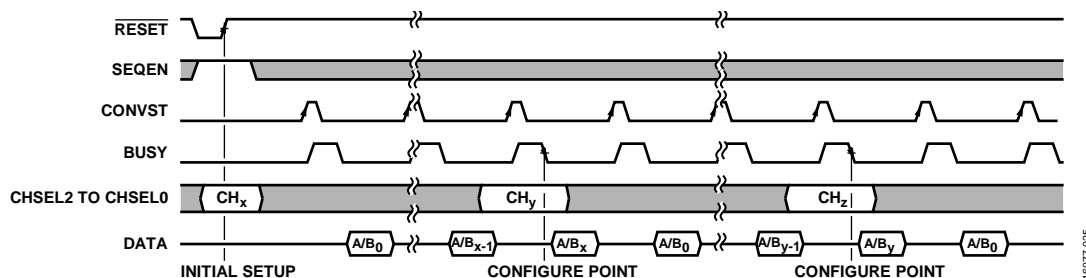

Figure 62. Hardware Mode Sequencer Configuration

To configure and enable the sequencer, it is recommended to complete the following procedure (see Figure 63):

1. Configure the analog input range for the required analog input channels.
2. Program the sequencer stack registers to select the channels for the sequence.
3. Set the SSREN<sub>x</sub> bit in the last required sequence step.
4. Set the SEQEN bit in the configuration register.
5. Provide a dummy CONVST pulse.
6. Cycle through CONVST pulses and conversion reads to step through each element of the sequencer stack.

The sequence automatically restarts from the first element in the sequencer stack with the next CONVST pulse.

Following a partial reset, the sequencer pointer is repositioned to the first layer of the stack, but the register programmed values remain unchanged.

## BURST SEQUENCER

Burst mode avoids generating a CONVST pulse for each step in a sequence of conversions. One CONVST pulse converts every step in the sequence.

The burst sequencer is an additional feature that works in conjunction with the sequencer. If the burst function is enabled, one CONVST pulse initiates a conversion of all the channels configured in the sequencer. The burst function avoids generating a CONVST pulse for each step in a sequence of conversions, as is the case when the burst function is disabled.

Configuration of the burst function varies depending on the mode of operation: hardware or software mode. See the Hardware Mode Burst section and the Software Mode Burst section for specific details on configuring the burst function in the each mode.

When configured, the burst sequence is initiated at the rising edge of CONVST. The BUSY pin goes high to indicate that a conversion is in progress. The BUSY pin remain high until all conversions in the sequence are complete. The conversion results are available for readback after the BUSY pin goes low.

The number of data reads required to read all the data in the burst sequence is dependent on the length of the sequence configured.

The conversion results are presented on the data bus (parallel or serial) in the same order as the programmed sequence.

The throughput rate of the AD7617 is limited in burst mode and dependent on the length of the sequence. Each channel pair requires an acquisition, conversion, and readback time. The time taken to complete a sequence with number of channel pairs,  $N$ , is estimated by

$$t_{BURST} = (t_{CONV} + 25 \text{ ns}) + (N - 1)(t_{ACQ} + t_{CONV}) + N(t_{RB})$$

where:

$t_{CONV}$  is the typical conversion time.

$t_{ACQ}$  is typical acquisition time.

$t_{RB}$  is the time required to read back the conversion results in either serial 1-wire, serial 2-wire, or parallel mode.

### Hardware Mode Burst

Burst mode is enabled in hardware mode by setting the BURST pin to 1. The SEQEN pin must also be set to 1 to enable the sequencer.

In hardware mode, the burst sequencer is controlled by the BURST, SEQEN, and CHSEL<sub>x</sub> pins. The burst sequencer is enabled or disabled when the AD7617 is released from full reset. The logic level of the SEQEN pin and the BURST pin when the RESET pin is released determines whether the burst sequencer is enabled or disabled. After the RESET pin is released, the function is fixed and a full reset via the RESET pin is required to exit the function and set up an alternative configuration.

When the burst sequencer is enabled, the logic levels of the CHSEL<sub>x</sub> pins determine the channels selected for conversion in the burst sequence. The CHSEL<sub>x</sub> pins at the time RESET is released determines the initial settings for the channels to convert in the burst sequence. To reconfigure the channels selected for conversion after a reset, set the CHSEL<sub>x</sub> pins to the required setting for the duration of the next BUSY pulse (see Figure 64 for further details).

### Software Mode Burst

In software mode, the burst function is enabled by setting the BURST bit in the configuration register to 1. This action must be performed when setting the SEQEN bit in the configuration register as outlined in the steps described in the Software Mode Sequencer section to configure the sequencer (see Figure 65 for additional information).

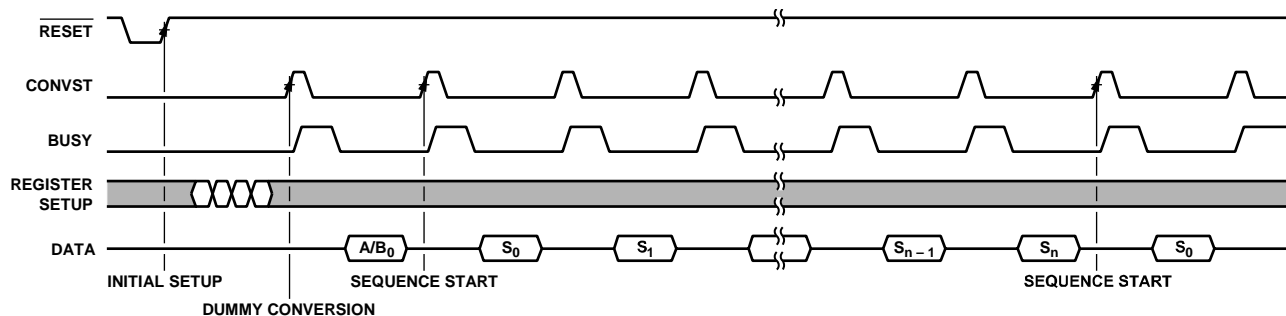
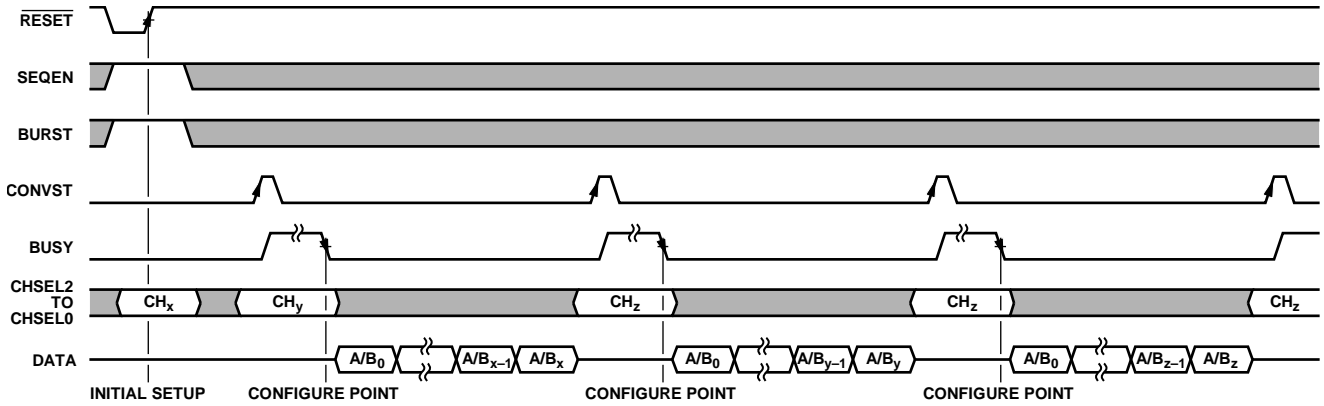
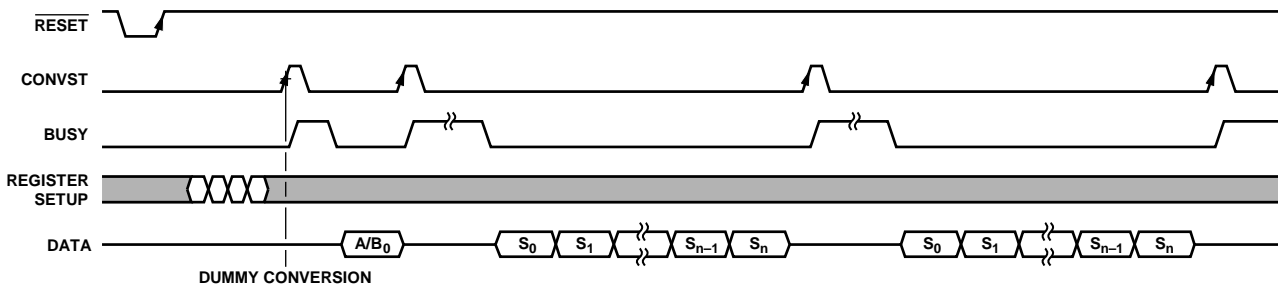

Figure 63. Software Mode Sequencer Configuration



16077-027



16077-028

# DIAGNOSTICS

## DIAGNOSTIC CHANNELS

In addition to the 16 analog inputs, VxA and VxB, the AD7617 can also convert the following diagnostic channels: VCC and the ALDO voltage. The diagnostic channels are selected for conversion by programming the channel register (see the Channel Register section) to the corresponding channel identifier. Diagnostic channels can also be added to the sequencer stack in software mode but only provide an accurate reading at throughput rates <250 kSPS. See Figure 66 for a plot of the deviation from expected value vs. sampling frequency that can be expected when using the diagnostic channels.

The expected output for each channel is governed by the following transfer functions:

$$V_{CC} \text{ Code} = \frac{((4 \times V_{CC}) - V_{REF}) \times 32,768}{5 \times V_{REF}}$$

$$LDO \text{ Code} = \frac{((10 \times V_{ALDO}) - (7 \times V_{REF})) \times 32,768}{10 \times V_{REF}}$$

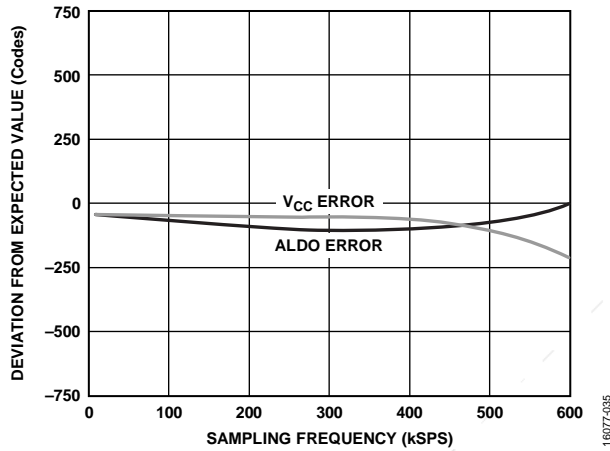

Figure 66. Deviation from Expected Value vs. Sampling Frequency

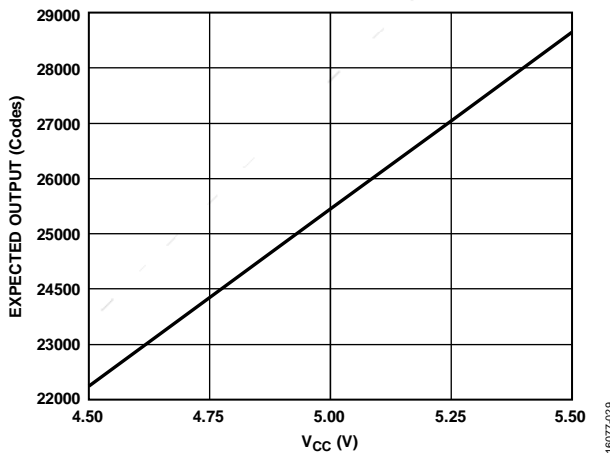

Figure 67. VCC Diagnostic Transfer Function

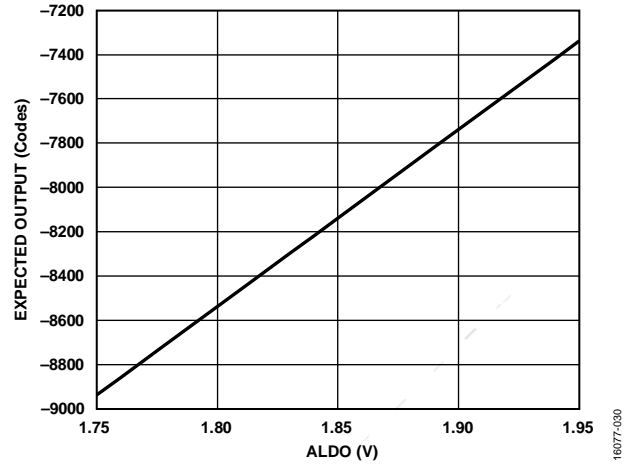

Figure 68. ALDO Diagnostic Transfer Function

## INTERFACE SELF TEST

It is possible to test the integrity of the digital interface by selecting the communication self test channel in the channel register (see the Channel Register section).

Selecting the communication self test for conversion forces the conversion result register to a known fixed output. When conversion code is read, Code 0x2AAA is output as the conversion code of ADC A, and Code 0x1555 is output as the conversion code of ADC B.

## CRC

The AD7617 has a cyclic redundancy check (CRC) checksum mode to improve interface robustness by detecting errors in data. The CRC feature is available in both software (serial and parallel) mode and hardware (serial only) mode. The CRC feature is not available in hardware parallel mode. The CRC result is contained within the status register. Enabling the CRC feature enables the status register and vice versa.

In hardware mode, the CRCEN pin controls the CRC feature. The CRC feature is enabled or disabled when the AD7617 is released from full reset. The logic level of the CRCEN pin when the RESET pin is released determines whether the CRC feature is enabled or disabled. Set the CRCEN pin to 1 to enable the CRC feature. After the RESET pin is released, the function is fixed and a full reset via the RESET pin is required to exit the function and set up an alternative configuration. See the Reset Functionality section for additional information. After being enabled, the CRC result is appended to the conversion result and consists of a 16-bit word, where the first eight bits contain the channel ID of the last channel pair converted and the last eight bits are the CRC result. The result is accessed via an extra read command, as shown in Figure 69.

In software mode, the CRC function is enabled by setting either the CRCEN bit or the STATUSEN bit in the configuration register to 1 (see the Status Register section).

If the CRC function is enabled, a CRC is calculated on the conversion results for Channel VxA and Channel VxB. The CRC is calculated and transferred on the serial or parallel interface after the conversion results are transmitted, depending on the configuration of the device. The Hamming distance varies relative to the number of bits in the conversion result. For conversions with  $\leq 119$  bits, the Hamming distance is 4. For  $> 119$  bits, the Hamming distance is 1, that is, 1-bit errors are always detected.

The CRC polynomial in use on the AD7617 is

$$x^8 + x^2 + x + 1$$

The following is a pseudocode description of how the CRC is implemented in the AD7617:

```

crc = 8'b0;
i = 0;
x = number of conversion channel pairs;
for (i=0, i<x, i++) begin
  crc1 = crc_out(An,Crc);
  crc = crc_out(Bn,Crc1);
  i = i +1;
end

```

where the function `crc_out(data, crc)` is

```

crc_out[0] = data[14] ^ data[12] ^ data[8] ^
data[7] ^ data[6] ^ data[0] ^ crc[0] ^
crc[4] ^ crc[6];
crc_out[1] = data[15] ^ data[14] ^ data[13]
^ data[12] ^ data[9] ^ data[6] ^ data[1] ^
data[0] ^ crc[1] ^ crc[4] ^ crc[5] ^ crc[6]
^ crc[7];

```

```

crc_out[2] = data[15] ^ data[13] ^ data[12]
^ data[10] ^ data[8] ^ data[6] ^ data[2] ^
data[1] ^ data[0] ^ crc[0] ^ crc[2] ^ crc[4]
^ crc[5] ^ crc[7];

```

```

crc_out[3] = data[14] ^ data[13] ^ data[11]
^ data[9] ^ data[7] ^ data[3] ^ data[2] ^
data[1] ^ crc[1] ^ crc[3] ^ crc[5] ^ crc[6];

```

```

crc_out[4] = data[15] ^ data[14] ^ data[12]
^ data[10] ^ data[8] ^ data[4] ^ data[3] ^
data[2] ^ crc[0] ^ crc[2] ^ crc[4] ^ crc[6]
^ crc[7];

```

```

crc_out[5] = data[15] ^ data[13] ^ data[11]
^ data[9] ^ data[5] ^ data[4] ^ data[3] ^
crc[1] ^ crc[3] ^ crc[5] ^ crc[7];

```

```

crc_out[6] = data[14] ^ data[12] ^ data[10]
^ data[6] ^ data[5] ^ data[4] ^ crc[2] ^
crc[4] ^ crc[6];

```

```

crc_out[7] = data[15] ^ data[13] ^ data[11]
^ data[7] ^ data[6] ^ data[5] ^ crc[3] ^
crc[5] ^ crc[7];

```

The initial CRC word used by the AD7617 is an 8-bit word equal to zero. The XOR operation described in the preceding code is executed to calculate each bit of the CRC word for the conversion result,  $A_N$ . This CRC word (`crc1`) is then used as the starting point for calculating the CRC word (`crc`) for the conversion result,  $B_N$ . The process repeats cyclically for each channel pair converted.

Depending on the mode of operation of the AD7617, the status register value is appended to the conversion data and read out via an extra read command over the serial or parallel interface. The user can then repeat the XOR calculation described in the preceding code for the received conversion results to check whether both CRC words match. See Figure 69 for a description of how the CRC word is appended to the data for each mode of operation.

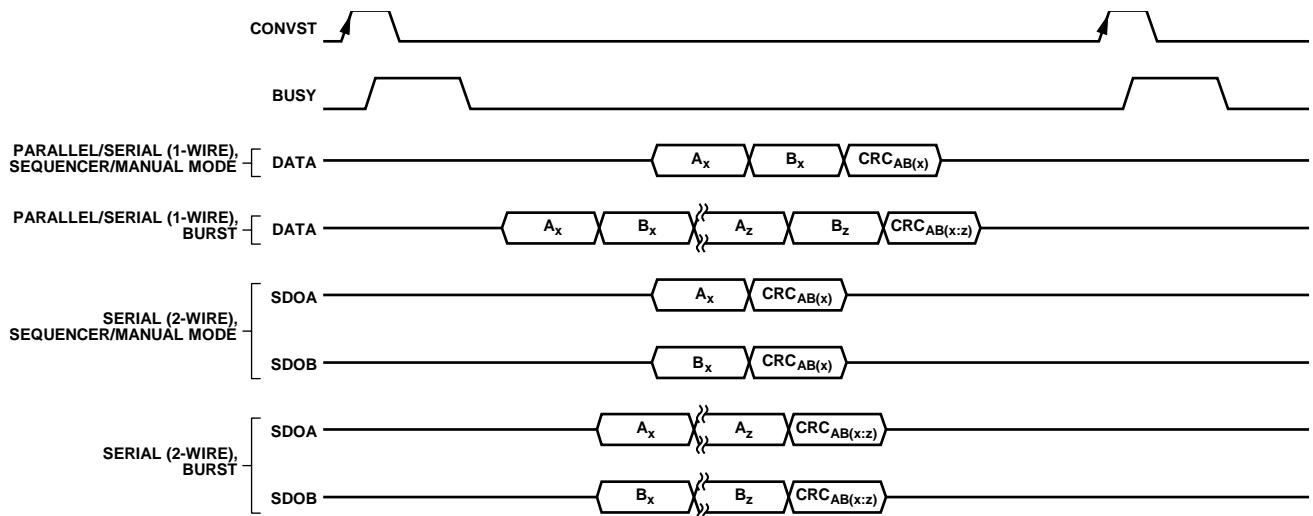

Figure 69. CRC Readback for All Modes

16077-032



## REGISTER SUMMARY

The AD7617 has six read/write registers used for configuring the device in software mode and an additional 32 sequencer stack registers for programming the flexible on-chip sequencer and a read only status register. Table 20 shows an overview of the read/write registers available on the AD7617. The status register is an additional read only register than contains information on the channel pair previously converted and the CRC result.

**Table 20. Register Summary<sup>1</sup>**

Reg.	Name	Bits	Bit 7	Bit 6	Bit 5	Bit 4	Bit 3	Bit 2	Bit 1	Bit 0	Reset	R/W
0x02	Configuration register	[15:8]	Addressing							Reserved	0x0000	R/W
		[7:0]	SDEF	BURSTEN	SEQEN	OS		STATUSEN	CRCEN			
0x03	Channel register	[15:8]	Addressing							Reserved	0x0000	R/W
		[7:0]	CHB				CHA					
0x04	Input Range Register A1	[15:8]	Addressing							Reserved	0x00FF	R/W
		[7:0]	V3A		V2A		V1A		V0A			
0x05	Input Range Register A2	[15:8]	Addressing							Reserved	0x00FF	R/W
		[7:0]	V7A		V6A		V5A		V4A			
0x06	Input Range Register B1	[15:8]	Addressing							Reserved	0x00FF	R/W
		[7:0]	V3B		V2B		VB1		V0B			
0x07	Input Range Register B2	[15:8]	Addressing							Reserved	0x00FF	R/W
		[7:0]	V7B		V6B		VB5		V4B			
0x20 to 0x3F	Sequencer Stack Registers 0 to Sequencer Stack Register 31	[15:8]	Addressing							SSREN0 to SSREN31	0x0000 <sup>2</sup>	R/W
		[7:0]	BSEL0 to BSEL31				ASEL0 to ASEL31					
N/A	Status register	[15:8]	A[3:0]				B[3:0]				N/A	R
		[7:0]	CRC[7:0]									

<sup>1</sup> N/A means not applicable.

<sup>2</sup> After a full or partial rest is issued, the sequencer stack register is reinitialized to cycle through Channel V0A and Channel V0B to Channel V7A and Channel V7B. The remaining 24 layers of the stack are reinitialized to 0x0.

**ADDRESSING REGISTERS**

The seven MSBs written to the device are decoded to determine which register is addressed. The seven MSBs consist of the register address (REGADDR), Bits[5:0], and the read/write bit. The register address bits determine which on-chip register is selected. The read/write bit determines if the remaining nine bits of data on the DB10/SDI lines are loaded into the addressed register. If the read/write bit is 1, the bits load into the register addressed by the register select bits. If the read/write bit is 0, the command is seen as a read request. The addressed register data is available to be read during the next read operation.

MSB			LSB
D15	D14	D13 to D9	D8 to D0
W/R	REGADDR, Bit 5	REGADDR, Bits[4:0]	DATA, Bits[8:0]

**Table 21. Bit Descriptions for the Addressing Registers**

Bits	Mnemonic	Description
D15	W/R	If a 1 is written to this bit, Bits[D8:D0] of this register are written to the register specified by REGADDR, Bits[5:0]. Alternatively, if a 0 is written, the next operation is a read from the designated register.
D14	REGADDR, Bit 5	If a 1 is written to this bit, the contents of REGADDR, Bits[4:0] specifies the 32 sequencer stack registers. Alternatively, if a 0 is written to this bit, a register is selected as defined by REGADDR, Bits[4:0].
[D13:D9]	REGADDR, Bits[4:0]	When $W/\bar{R} = 1$ , the contents of REGADDR, Bits[4:0] determine register for selection as follows:  00001: reserved. 00010: selects the configuration register. 00011: selects the channel register. 00100: selects Input Range Register A1. 00101: selects Input Range Register A2. 00110: selects Input Range Register B1. 00111: selects Input Range Register B2. 01000: selects the status register When $W/\bar{R} = 0$ and REGADDR, Bits[4:0] contains 00000, the conversion codes are read.
[D8:D0]	DATA, Bits[8:0]	These bits are written into the corresponding register specified by REGADDR, Bits[5:0]. See the following sections for detailed descriptions of each register.

### CONFIGURATION REGISTER

The configuration register is used in software mode to configure many of the main functions of the ADC, including the sequencer, burst mode, oversampling, and CRC options.

Address: 0x02, Reset: 0x0000, Name: Configuration Register

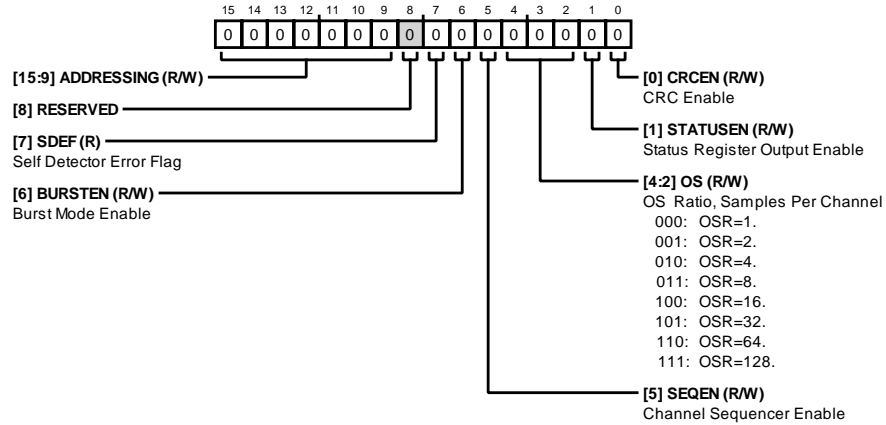

Table 22. Bit Descriptions for the Configuration Register

Bits	Bit Name	Settings	Description	Reset <sup>1</sup>	Access
[15:9]	Addressing	0	Bits[15:9] define the address of the relevant register. See the Addressing Registers section for further details.	0x0	RW
8	RESERVED		Reserved.	0x0	R/W
7	SDEF	0 1	Self Detector Error Flag. 0 Test passed. The AD7617 has configured itself successfully after power-up. 1 Test failed. An issue was detected during device configuration. A reset is required.	N/A	R
6	BURSTEN	0 1	Burst mode enable. 0 Burst mode is disabled. Each channel pair to be converted requires a CNVST pulse. 1 A single CNVST pulse converts every channel pair programmed in the 32-layer sequencer stack registers up to and including the layer defined by the SSRENx bit. See the Software Mode Sequencer section and the Software Mode Burst section for further details.	0x0	RW
5	SEQEN	0 1	Channel Sequencer Enable. 0 The channel sequencer is disabled. 1 The channel sequencer is enabled.	0x0	RW
[4:2]	OS	000 001 010 011 100 101 110 111	Oversampling (OS) Ratio, Samples Per Channel. 000 Oversampling disabled. OSR = 1. 001 Oversampling enabled, OSR = 2. 010 Oversampling enabled, OSR = 4. 011 Oversampling enabled, OSR = 8. 100 Oversampling enabled, OSR = 16. 101 Oversampling enabled, OSR = 32. 110 Oversampling enabled, OSR = 64. 111 Oversampling enabled, OSR = 128.	0x0	RW
1	STATUSEN	0 1	Status register output enable. 0 The status register is not read out when reading the conversion result. 1 The status register is read out at the end of all the conversion words (including the self test channel if enabled in sequencer mode) if all the selected channels are read out. The CRC result is included in the last eight bits.	0x0	RW
0	CRCEN		CRC Enable. The STATUSEN and CRCEN bits have identical functionality.	0x0	RW

<sup>1</sup> N/A means not applicable.

**CHANNEL REGISTER**

Address: 0x03, Reset: 0x0000, Name: Channel Register

In software manual mode, the channel register selects the input channel or self test channel for the next conversion.

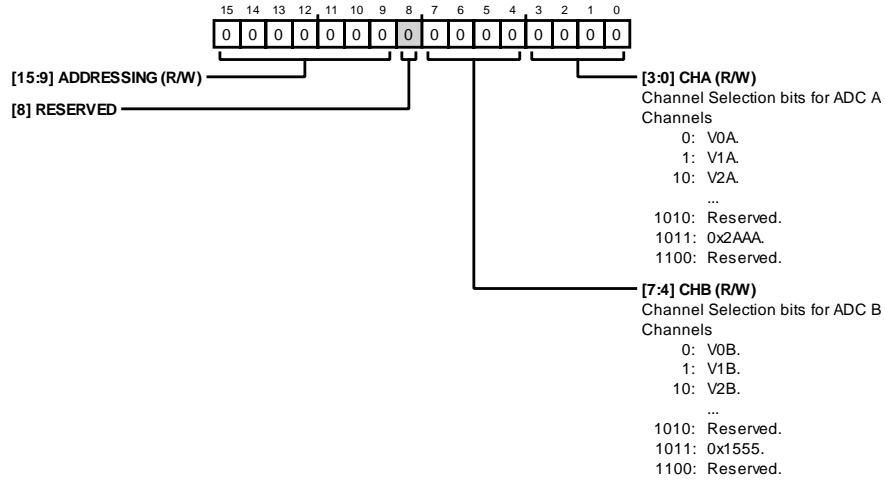

Table 23. Bit Descriptions for the Channel Register

Bits	Bit Name	Settings	Description	Reset	Access
[15:9]	Addressing		Bits[15:9] define the address of the relevant register. See the Addressing Registers section for further details.	0x0	R/W
8	RESERVED		Reserved.	0x0	R/W
[7:4]	CHB	0000 V0B. 0001 V1B. 0010 V2B. 0011 V3B. 0100 V4B. 0101 V5B. 0110 V6B. 0111 V7B. 1000 V <sub>CC</sub> . 1001 ALDO. 1010 Reserved. 1011 Set the dedicated bits for digital interface communication self test function. When conversion codes are read, Code 0x2AAA is read out as the conversion code of Channel A, and Code 0x1555 is output as the conversion code of Channel B. 1100 Reserved.	Channel Selection Bits for ADC B Channels.	0x0	R/W
[3:0]	CHA		Channel Selection Bits for ADC A Channels. Settings are the same as for ADC B.	0x0	R/W

**INPUT RANGE REGISTERS**

Input Range Register A1 and Input Range Register A2 select from one of the three possible input ranges ( $\pm 10$  V,  $\pm 5$  V, or  $\pm 2.5$  V) for Analog Input Channel V0A to Channel V7A. Input Range Register B1 and Input Range Register B2 select from one of the three possible input ranges ( $\pm 10$  V,  $\pm 5$  V, or  $\pm 2.5$  V) for Analog Input Channel V0B to Channel V7B.

**Input Range Register A1**

Address: 0x04, Reset: 0x00FF, Name: Input Range Register A1

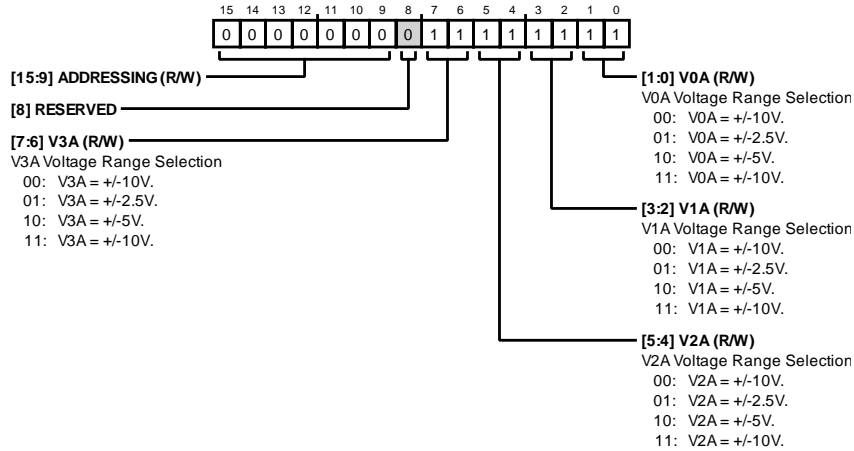
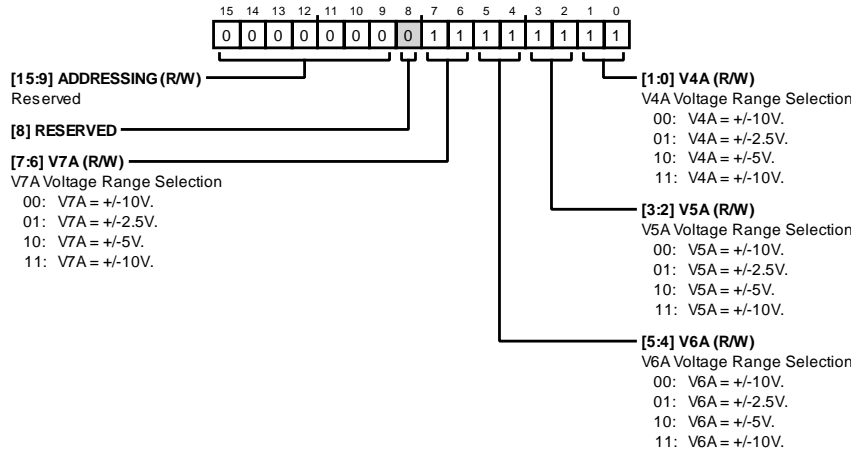

**Table 24. Bit Descriptions for Input Range Register A1**

Bits	Bit Name	Settings	Description	Reset	Access
[15:9]	Addressing		Bits[15:9] define the address of the relevant register. See the Addressing Registers section for further details.	0x0	R/W
8	RESERVED		Reserved.	0x0	R/W
[7:6]	V3A	00 01 10 11	V3A Voltage Range Selection. V3A $\pm 10$ V. V3A $\pm 2.5$ V. V3A $\pm 5$ V. V3A $\pm 10$ V.	0x3	R/W
[5:4]	V2A	00 01 10 11	V2A Voltage Range Selection. V2A $\pm 10$ V. V2A $\pm 2.5$ V. V2A $\pm 5$ V. V2A $\pm 10$ V.	0x3	R/W
[3:2]	V1A	00 01 10 11	V1A Voltage Range Selection. V1A $\pm 10$ V. V1A $\pm 2.5$ V. V1A $\pm 5$ V. V1A $\pm 10$ V.	0x3	R/W
[1:0]	V0A	00 01 10 11	V0A Voltage Range Selection. V0A $\pm 10$ V. V0A $\pm 2.5$ V. V0A $\pm 5$ V. V0A $\pm 10$ V.	0x3	R/W

**Input Range Register A2**

Address: 0x05, Reset: 0x00FF, Name: Input Range Register A2

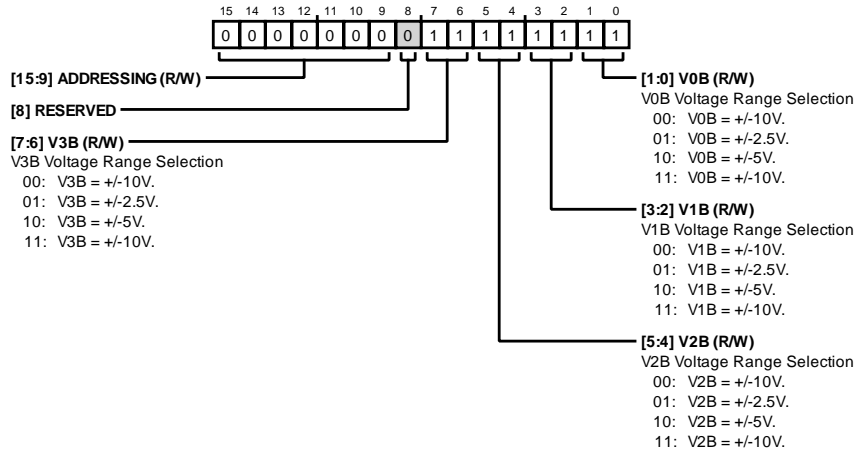

**Table 25. Bit Descriptions for Input Range Register A2**

Bits	Bit Name	Settings	Description	Reset	Access
[15:9]	Addressing		Bits[15:9] define the address of the relevant register. See the Addressing Registers section for further details.	0x0	R/W
8	RESERVED		Reserved.	0x0	R/W
[7:6]	V7A	00 01 10 11	V7A Voltage Range Selection. V7A ± 10 V. V7A ± 2.5 V. V7A ± 5 V. V7A ± 10 V.	0x3	R/W
[5:4]	V6A	00 01 10 11	V6A Voltage Range Selection. V6A ± 10 V. V6A ± 2.5 V. V6A ± 5 V. V6A ± 10 V.	0x3	R/W
[3:2]	V5A	00 01 10 11	V5A Voltage Range Selection. V5A ± 10 V. V5A ± 2.5 V. V5A ± 5 V. V5A ± 10 V.	0x3	R/W
[1:0]	V4A	00 01 10 11	V4A Voltage Range Selection. V4A ± 10 V. V4A ± 2.5 V. V4A ± 5 V. V4A ± 10 V.	0x3	R/W

**Input Range Register B1**

Address: 0x06, Reset: 0x00FF, Name: Input Range Register B1

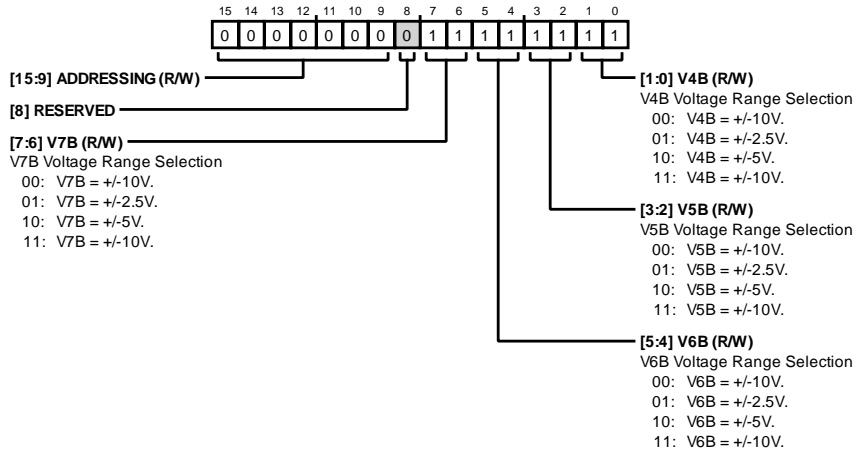

**Table 26. Bit Descriptions for Input Range Register B1**

Bits	Bit Name	Settings	Description	Reset	Access
[15:9]	Addressing		Bits[15:9] define the address of the relevant register. See the Addressing Registers section for further details.	0x0	R/W
8	RESERVED		Reserved.	0x0	R/W
[7:6]	V3B	00 01 10 11	V3B Voltage Range Selection. V3B ± 10 V. V3B ± 2.5 V. V3B ± 5 V. V3B ± 10 V.	0x3	R/W
[5:4]	V2B	00 01 10 11	V2B Voltage Range Selection. V2B ± 10 V. V2B ± 2.5 V. V2B ± 5 V. V2B ± 10 V.	0x3	R/W
[3:2]	VB1	00 01 10 11	VB1 Voltage Range Selection. VB1 ± 10 V. VB1 ± 2.5 V. VB1 ± 5 V. VB1 ± 10 V.	0x3	R/W
[1:0]	V0B	00 01 10 11	V0B Voltage Range Selection. V0B ± 10 V. V0B ± 2.5 V. V0B ± 5 V. V0B ± 10 V.	0x3	R/W

**Input Range Register B2**

Address: 0x07, Reset: 0x00FF, Name: Input Range Register B2



**Table 27. Bit Descriptions for Input Range Register B2**

Bits	Bit Name	Settings	Description	Reset	Access
[15:9]	Addressing		Bits[15:9] define the address of the relevant register. See the Addressing Registers section for further details.	0x0	R/W
8	RESERVED		Reserved.	0x0	R/W
[7:6]	V7B	00 01 10 11	V7B Voltage Range Selection. V7B ± 10 V. V7B ± 2.5 V. V7B ± 5 V. V7B ± 10 V.	0x3	R/W
[5:4]	V6B	00 01 10 11	V6B Voltage Range Selection. V6B ± 10 V. V6B ± 2.5 V. V6B ± 5 V. V6B ± 10 V.	0x3	R/W
[3:2]	V5B	00 01 10 11	V5B Voltage Range Selection. V5B ± 10 V. V5B ± 2.5 V. V5B ± 5 V. V5B ± 10 V.	0x3	R/W
[1:0]	V4B	00 01 10 11	V4B Voltage Range Selection. V4B ± 10 V. V4B ± 2.5 V. V4B ± 5 V. V4B ± 10 V.	0x3	R/W



### SEQUENCER STACK REGISTERS

Although the channel register defines the next channel for conversion (be it a diagnostic channel or pair of analog input channels), to sample numerous analog input channels, the 32 sequencer stack registers offer a convenient solution. Within the communication register, when the REGADDR5 bit is set to Logic 1, the contents of REGADDR[4:0] specifies 1 of the 32 sequencer stack registers. Within each sequencer stack register, the user can define a pair of analog inputs to sample simultaneously.

The structure of the sequence forms a stack, in which each row represents two channels to convert simultaneously. The sequence begins with Sequencer Stack Register 1 and cycles through to Sequencer Stack Register 32. If Bit D8 (the enable bit, SSRENx) within a sequencer stack register is set to 1, the sequence ends with the pair of analog inputs defined by that register, then returns to the first sequencer stack register, and resumes the cycle again. By default, the sequencer stack registers are programmed to cycle through Channel V0A and Channel V0B to Channel V7A and Channel V7B. After a full or partial reset is issued, the sequencer stack register reinitializes to cycle through Channel V0A and Channel V0B to Channel V7A and Channel V7B.

**Address: 0x20 to 0x3F, Reset: 0x0000, Name: Sequencer Stack Register 0 to Sequencer Stack Register 31**

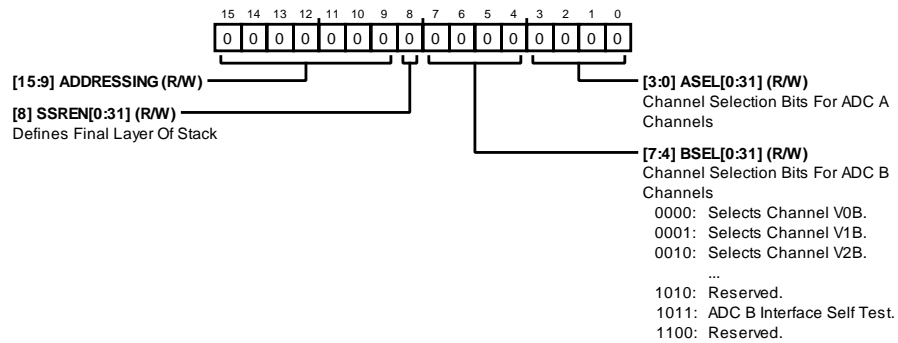

**Table 28. Bit Descriptions for Sequencer Stack Register 0 to Sequencer Stack Register 31**

Bits	Bit Name	Settings	Description	Reset	Access
[15:9]	Addressing		Bits[15:9] define the address of the relevant register. See the Addressing Registers section for further details.	0x0	R/W
8	SSREN0 to SSREN31		Setting this bit to 0 instructs the ADC to move to the next layer of the sequencer stack after converting the present channel pair. Setting this bit to 1 defines that layer of the sequencer stack as the final layer in the sequence. Thereafter, the sequencer loops back to the first layer of the stack.	0x0	R/W
[7:4]	BSEL0 to BSEL31	0000 V0B. 0001 V1B. 0010 V2B. 0011 V3B. 0100 V4B. 0101 V5B. 0110 V6B. 0111 V7B. 1000 V <sub>CC</sub> . 1001 ALDO. 1010 Reserved. 1011 Set the dedicated bits for digital interface communication self test function. When the conversion codes is read, Code 0x2AAA is read out as the conversion code of Channel A, and Code 0x1555 is output as the conversion code of Channel B. 1100 Reserved.	Channel selection bits for ADC B channels.	0x0 <sup>1</sup>	R/W
[3:0]	ASEL0 to ASEL31		Channel selection bits for ADC A channels. Settings are the same as for ADC B.	0x0 <sup>1</sup>	R/W

<sup>1</sup> After a full or partial reset is issued, the sequencer stack register is reinitialized to cycle through Channel V0A and Channel V0B to Channel V7A and Channel V7B. The remaining 24 layers of the stack are reinitialized to 0x0.

**STATUS REGISTER**

The status register is a 16-bit read only register. If the STATUSEN bit or the CRCEN bit is set to Logic 1 in the configuration register, the status register is read out at the end of all conversion words for the selected channels, including the self test channel if enabled in sequencer mode. Consult the CRC section and Figure 69.

MSB														LSB	
D15	D14	D13	D12	D11	D10	D9	D8	D7	D6	D5	D4	D3	D2	D1	D0
A, Bits[3:0]				B, Bits[3:0]				CRC, Bits[7:0]							

**Table 29. Bit Descriptions for Status Register**

Bit	Bit Name	Settings	Description	Reset <sup>1</sup>	Access
[D15:D12]	A[3:0]		Channel Index for Previous Conversion Result on Channel A.	N/A	R
[D11:D8]	B[3:0]		Channel Index for Previous Conversion Result on Channel B.	N/A	R
[D7:D0]	CRC[7:0]		CRC Calculation for the Previous Conversion Result(S). Refer to the CRC section for further details.	N/A	R

<sup>1</sup> N/A means not applicable.

# OUTLINE DIMENSIONS

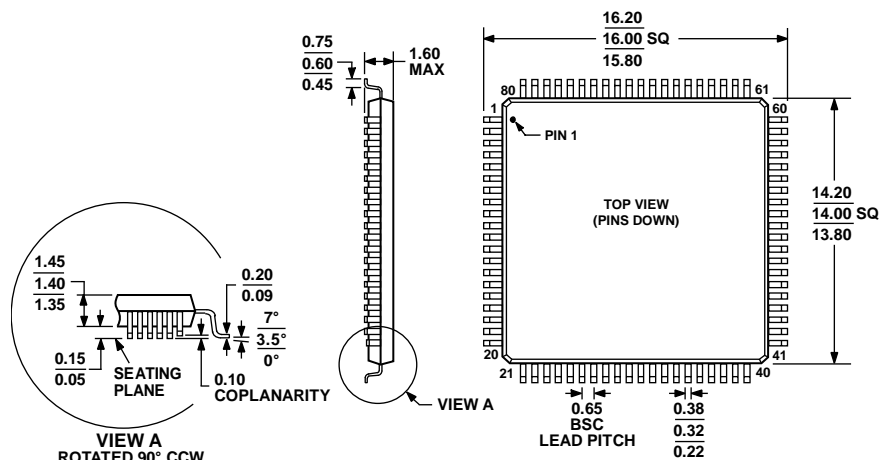

COMPLIANT TO JEDEC STANDARDS MS-026-BEC

Figure 70. 80-Lead Low Profile Quad Flat Package [LQFP] (ST-80-2)

Dimensions shown in millimeters

051706-A

## ORDERING GUIDE

Model <sup>1, 2</sup>	Temperature Range	Package Description	Package Option
AD7617BSTZ	-40°C to +125°C	80-Lead Low Profile Quad Flat Package [LQFP]	ST-80-2
AD7617BSTZ-RL	-40°C to +125°C	80-Lead Low Profile Quad Flat Package [LQFP], 13" Reel	ST-80-2
EVAL-AD7616SDZ		Use the AD7616 Evaluation Board	

<sup>1</sup> Z = RoHS Compliant Part.

<sup>2</sup> The EVAL-AD7616SDZ can evaluate the AD7616 and AD7617.

Компания «Life Electronics» занимается поставками электронных компонентов импортного и отечественного производства от производителей и со складов крупных дистрибьюторов Европы, Америки и Азии.

С конца 2013 года компания активно расширяет линейку поставок компонентов по направлению коаксиальный кабель, кварцевые генераторы и конденсаторы (керамические, пленочные, электролитические), за счёт заключения дистрибьюторских договоров

Мы предлагаем:

- Конкурентоспособные цены и скидки постоянным клиентам.
- Специальные условия для постоянных клиентов.
- Подбор аналогов.
- Поставку компонентов в любых объемах, удовлетворяющих вашим потребностям.
- Приемлемые сроки поставки, возможна ускоренная поставка.
- Доставку товара в любую точку России и стран СНГ.
- Комплексную поставку.
- Работу по проектам и поставку образцов.
- Формирование склада под заказчика.
- Сертификаты соответствия на поставляемую продукцию (по желанию клиента).
- Тестирование поставляемой продукции.
- Поставку компонентов, требующих военную и космическую приемку.
- Входной контроль качества.
- Наличие сертификата ISO.

В составе нашей компании организован Конструкторский отдел, призванный помогать разработчикам, и инженерам.

Конструкторский отдел помогает осуществить:

- Регистрацию проекта у производителя компонентов.
- Техническую поддержку проекта.
- Защиту от снятия компонента с производства.
- Оценку стоимости проекта по компонентам.
- Изготовление тестовой платы монтаж и пусконаладочные работы.



Тел: +7 (812) 336 43 04 (многоканальный)

Email: [org@lifeelectronics.ru](mailto:org@lifeelectronics.ru)