

## FEATURES

- 26 reset threshold options**
  - 2.5 V to 5 V in 100 mV increments
- 4 reset timeout options**
  - 1 ms, 20 ms, 140 ms, and 1120 ms (minimum)
- 4 watchdog timeout options**
  - 6.3 ms, 102 ms, 1600 ms, and 25.6 sec (typical)
- Manual reset input**
- Reset output stages**
  - Push-pull active low
  - Open-drain active low
  - Push-pull active high
- Low power consumption: 5  $\mu$ A**
- Guaranteed reset output valid to  $V_{CC} = 1$  V**
- Power supply glitch immunity**
- Specified over industrial temperature range**
- 5-lead SOT-23 package**

## APPLICATIONS

- Microprocessor systems
- Computers
- Controllers
- Intelligent instruments
- Portable equipment

## GENERAL DESCRIPTION

The ADM6316/ADM6318/ADM6319/ADM6320/ADM6321/ADM6322 are supervisory circuits that monitor power supply voltage levels and code execution integrity in microprocessor-based systems. As well as providing power-on reset signals, an on-chip watchdog timer can reset the microprocessor if it fails to strobe within a preset timeout period. A reset signal can also be asserted by an external push button through a manual reset input. The seven devices feature different combinations of watchdog input, manual reset input, and output stage configuration, as shown in Table 1.

Table 1. Selection Table

| Part No. | Watchdog | Manual Reset | Output Stage |           |
|----------|----------|--------------|--------------|-----------|
|          |          |              | RESET        | RESET     |
| ADM6316  | Yes      | Yes          | Push-pull    | No        |
| ADM6318  | Yes      | No           | Push-pull    | Push-pull |
| ADM6319  | No       | Yes          | Push-pull    | Push-pull |
| ADM6320  | Yes      | Yes          | Open-drain   | No        |
| ADM6321  | Yes      | No           | Open-drain   | Push-pull |
| ADM6322  | No       | Yes          | Open-drain   | Push-pull |

Rev. J

[Document Feedback](#)

Information furnished by Analog Devices is believed to be accurate and reliable. However, no responsibility is assumed by Analog Devices for its use, nor for any infringements of patents or other rights of third parties that may result from its use. Specifications subject to change without notice. No license is granted by implication or otherwise under any patent or patent rights of Analog Devices. Trademarks and registered trademarks are the property of their respective owners.

## FUNCTIONAL BLOCK DIAGRAMS



Figure 1.

04533-001

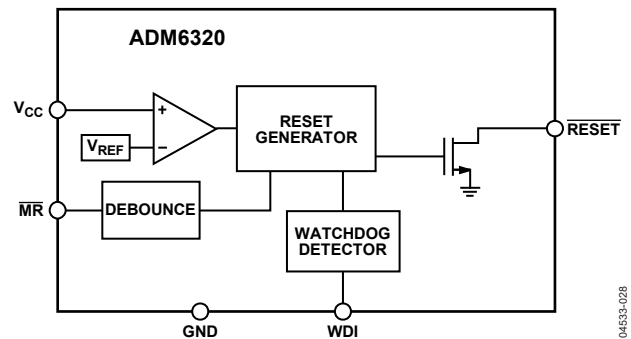

Figure 2.

04533-028

Each device is available in a choice of 26 reset threshold options ranging from 2.5 V to 5 V in 100 mV increments. There are also four reset timeout options of 1 ms, 20 ms, 140 ms, and 1120 ms (minimum) and four watchdog timeout options of 6.3 ms, 102 ms, 1600 ms, and 25.6 sec (typical). Not all device options are released for sale as standard models. See the Ordering Guide for details.

The ADM6316/ADM6318/ADM6319/ADM6320/ADM6321/ADM6322 are available in 5-lead SOT-23 packages and typically consume only 3  $\mu$ A, making them suitable for use in low power portable applications.

## TABLE OF CONTENTS

|  |   |   |    |
|--|---|---|----|
| Features .....                                     | 1 | Open-Drain $\overline{\text{RESET}}$ Output .....   | 9  |
| Applications .....                                 | 1 | Manual Reset Input .....                            | 9  |
| Functional Block Diagrams .....                    | 1 | Watchdog Input .....                                | 9  |
| General Description .....                          | 1 | Applications Information .....                      | 10 |
| Revision History .....                             | 2 | Watchdog Input Current .....                        | 10 |
| Specifications .....                               | 3 | Negative Going $V_{CC}$ Transients .....            | 10 |
| Absolute Maximum Ratings .....                     | 5 | Ensuring Reset Valid to $V_{CC} = 0\text{ V}$ ..... | 10 |
| ESD Caution .....                                  | 5 | Watchdog Software Considerations .....              | 10 |
| Pin Configurations and Function Descriptions ..... | 6 | Device Model Options .....                          | 11 |
| Typical Performance Characteristics .....          | 7 | Outline Dimensions .....                            | 13 |
| Circuit Description .....                          | 9 | Ordering Guide .....                                | 13 |
| Reset Output .....                                 | 9 |   |    |

## REVISION HISTORY

### 7/2018—Rev. I to Rev. J

|   |            |
|---|------------|
| Deleted ADM6317 .....                           | Throughout |
| Deleted Figure 4, Renumbered Sequentially ..... | 6          |
| Changes to Table 4 .....                        | 6          |
| Changes to Ordering Guide .....                 | 13         |

### 3/2018—Rev. H to Rev. I

|   |    |
|---|----|
| Changes to General Description Section .....                        | 1  |
| Added Note 1, Table 2 .....   | 3  |
| Changed Model Options Section to Device Model Options Section ..... | 11 |
| Changes to Device Model Options Section and Table 5 .....           | 11 |
| Deleted Table 8; Renumbered Sequentially .....                      | 12 |
| Changes to Ordering Guide .....                                     | 13 |

### 12/2015—Rev. G to Rev. H

|  |    |
|--|----|
| Added Endnote 1 and Endnote 2, Table 2 ..... | 3  |
| Change to Model Options Section Title .....  | 11 |
| Added Endnote 1, Table 5 .....               | 11 |
| Changes to Table 8 .....                     | 12 |
| Changes to Ordering Guide .....              | 14 |

### 1/2015—Rev. F to Rev. G

|                          |    |
|--------------------------|----|
| Changes to Table 8 ..... | 12 |
|--------------------------|----|

### 5/2013—Rev. E to Rev. F

|                                 |    |
|---------------------------------|----|
| Changes to Table 8 .....        | 12 |
| Changes to Ordering Guide ..... | 13 |

### 10/2010—Rev. D to Rev. E

|                                  |    |
|----------------------------------|----|
| Changes to Table 8 .....         | 12 |
| Updated Outline Dimensions ..... | 13 |

### 8/2008—Rev. C to Rev. D

|                           |   |
|---------------------------|---|
| Change to Figure 18 ..... | 9 |
|---------------------------|---|

### 4/2007—Rev. B to Rev. C

|                                 |    |
|---------------------------------|----|
| Added Figure 2 .....            | 1  |
| Changes to Figure 23 .....      | 13 |
| Changes to Ordering Guide ..... | 13 |

### 1/2007—Rev. A to Rev. B

|   |    |
|---|----|
| Changes to Functional Block Diagram ..... | 1  |
| Changes to Figure 18 .....                | 10 |

### 5/2006—Rev. 0 to Rev. A

|   |           |
|---|-----------|
| Updated Format .....                      | Universal |
| Changes to Functional Block Diagram ..... | 1         |
| Changes to Table 8 .....                  | 12        |
| Changes to Figure 22 .....                | 13        |
| Changes to Ordering Guide .....           | 13        |

### 10/2004—Revision 0: Initial Version

## SPECIFICATIONS

$V_{CC}$  = full operating range,  $T_A$  =  $T_{MIN}$  to  $T_{MAX}$ , unless otherwise noted.

Table 2.

| Parameter  | Min                                  | Typ      | Max                                  | Unit                  | Test Conditions/Comments   |
|--|--------------------------------------|----------|--------------------------------------|-----------------------|--|
| SUPPLY   |                                      |          |                                      |                       |  |
| $V_{CC}$ Operating Voltage Range                               | 1                                    |          | 5.5                                  | V                     |  |
| Supply Current   |                                      | 10       | 20                                   | $\mu$ A               | $V_{CC} = 5.5$ V   |
|  |                                      | 5        | 12                                   | $\mu$ A               | $V_{CC} = 3.6$ V   |
| RESET THRESHOLD VOLTAGE <sup>1</sup>                           | $V_{TH} - 1.5\%$<br>$V_{TH} - 2.5\%$ | $V_{TH}$ | $V_{TH} + 1.5\%$<br>$V_{TH} + 2.5\%$ | V                     | $T_A = 25^\circ\text{C}$<br>$T_A = -40^\circ\text{C}$ to $+85^\circ\text{C}$ |
| RESET THRESHOLD TEMPERATURE COEFFICIENT                        |                                      | 40       |                                      | ppm/ $^\circ\text{C}$ |  |
| RESET THRESHOLD HYSTERESIS                                     |                                      | 3        |                                      | mV                    |  |
| RESET TIMEOUT PERIOD <sup>1</sup>                              |                                      |          |                                      |                       |  |
| ADM63xxA <sup>2</sup>  | 1                                    | 1.4      | 2                                    | ms                    |  |
| ADM63xxB <sup>2</sup>  | 20                                   | 28       | 40                                   | ms                    |  |
| ADM63xxC <sup>2</sup>  | 140                                  | 200      | 280                                  | ms                    |  |
| ADM63xxD <sup>2</sup>  | 1120                                 | 1600     | 2240                                 | ms                    |  |
| $V_{CC}$ TO RESET DELAY  |                                      | 40       |                                      | $\mu$ s               | $V_{CC}$ falling at 1 mV/ $\mu$ s  |
| PUSH-PULL OUTPUT (ADM6316, ADM6318, ADM6319, ADM6321, ADM6322) |                                      |          |                                      |                       |  |
| $\overline{\text{RESET}}$ Output Voltage                       |                                      |          | 0.3                                  | V                     | $V_{CC} \geq 1.0$ V, $I_{SINK} = 50$ $\mu$ A                                 |
|  |                                      |          | 0.3                                  | V                     | $V_{CC} \geq 1.2$ V, $I_{SINK} = 100$ $\mu$ A                                |
|  |                                      |          | 0.3                                  | V                     | $V_{CC} \geq 2.7$ V, $I_{SINK} = 1.2$ mA                                     |
|  |                                      |          | 0.4                                  | V                     | $V_{CC} \geq 4.5$ V, $I_{SINK} = 3.2$ mA                                     |
|  | $0.8 \times V_{CC}$                  |          |                                      | V                     | $V_{CC} \geq 2.7$ V, $I_{SOURCE} = 500$ $\mu$ A                              |
|  | $V_{CC} - 1.5$                       |          |                                      | V                     | $V_{CC} \geq 4.5$ V, $I_{SOURCE} = 800$ $\mu$ A                              |
| $\overline{\text{RESET}}$ Rise Time                            |                                      | 5        | 25                                   | ns                    | From 10% to 90% $V_{CC}$ , $C_L = 5$ pF, $V_{CC} = 3.3$ V                    |
| RESET Output Voltage   |                                      |          | 0.3                                  | V                     | $V_{CC} \geq 2.7$ V, $I_{SINK} = 1.2$ mA                                     |
|  |                                      |          | 0.4                                  | V                     | $V_{CC} \geq 4.5$ V, $I_{SINK} = 3.2$ mA                                     |
|  | $0.8 \times V_{CC}$                  |          |                                      | V                     | $V_{CC} \geq 1.8$ V, $I_{SOURCE} = 150$ $\mu$ A                              |
|  | $0.8 \times V_{CC}$                  |          |                                      | V                     | $V_{CC} \geq 2.7$ V, $I_{SOURCE} = 500$ $\mu$ A                              |
|  | $V_{CC} - 1.5$                       |          |                                      | V                     | $V_{CC} \geq 4.5$ V, $I_{SOURCE} = 800$ $\mu$ A                              |
| OPEN-DRAIN OUTPUT (ADM6320, ADM6321, ADM6322)                  |                                      |          |                                      |                       |  |
| $\overline{\text{RESET}}$ Output Voltage                       |                                      |          | 0.3                                  | V                     | $V_{CC} \geq 1.0$ V, $I_{SINK} = 50$ $\mu$ A                                 |
|  |                                      |          | 0.3                                  | V                     | $V_{CC} \geq 1.2$ V, $I_{SINK} = 100$ $\mu$ A                                |
|  |                                      |          | 0.3                                  | V                     | $V_{CC} \geq 2.7$ V, $I_{SINK} = 1.2$ mA                                     |
|  |                                      |          | 0.4                                  | V                     | $V_{CC} \geq 4.5$ V, $I_{SINK} = 3.2$ mA                                     |
| Open-Drain Reset Output Leakage Current                        |                                      |          | 1                                    | $\mu$ A               |  |
| WATCHDOG INPUT (ADM6316, ADM6318, ADM6320, ADM6321)            |                                      |          |                                      |                       |  |
| Watchdog Timeout Period <sup>1</sup>                           |                                      |          |                                      |                       |  |
| ADM63xxxW <sup>3</sup>   | 4.3                                  | 6.3      | 9.3                                  | ms                    |  |
| ADM63xxxX <sup>3</sup>   | 71                                   | 102      | 153                                  | ms                    |  |
| ADM63xxxY <sup>3</sup>   | 1.12                                 | 1.6      | 2.4                                  | sec                   |  |
| ADM63xxxZ <sup>3</sup>   | 17.9                                 | 25.6     | 38.4                                 | sec                   |  |
| WDI Pulse Width  | 50                                   |          |                                      | ns                    | $V_{IL} = 0.3 \times V_{CC}$ , $V_{IH} = 0.7 \times V_{CC}$                  |
| WDI Input Threshold  | $0.3 \times V_{CC}$                  |          | $0.7 \times V_{CC}$                  | V                     |  |
| WDI Input Current  |                                      | 120      | 160                                  | $\mu$ A               | $V_{WDI} = V_{CC}$ , time average  |
|  | -20                                  | -15      |                                      | $\mu$ A               | $V_{WDI} = 0$ , time average   |

| Parameter   | Min                        | Typ | Max                        | Unit          | Test Conditions/Comments        |
|---|----------------------------|-----|----------------------------|---------------|---------------------------------|
| MANUAL RESET INPUT (ADM6316, ADM6319, ADM6320, ADM6322) |                            |     |                            |               |                                 |
| $\overline{\text{MR}}$ Input Threshold                  | 0.8                        |     | 2.0                        | V             | $V_{\text{TH}} > 4.0 \text{ V}$ |
|   | $0.3 \times V_{\text{CC}}$ |     | $0.7 \times V_{\text{CC}}$ | V             | $V_{\text{TH}} < 4.0 \text{ V}$ |
| $\overline{\text{MR}}$ Input Pulse Width                | 1                          |     |                            | $\mu\text{s}$ |                                 |
| $\overline{\text{MR}}$ Glitch Rejection                 |                            | 100 |                            | ns            |                                 |
| $\overline{\text{MR}}$ Pull-Up Resistance               | 35                         | 52  | 75                         | k $\Omega$    |                                 |
| $\overline{\text{MR}}$ to Reset Delay                   |                            | 230 |                            | ns            | $V_{\text{CC}} = 5 \text{ V}$   |

<sup>1</sup> Not all device options are released for sale as standard models. See the Ordering Guide for full details.

<sup>2</sup> Complete the model code by replacing xx with a device generic number.

<sup>3</sup> Complete the model code by replacing xxx with a device generic number and code for the reset timeout period.

## ABSOLUTE MAXIMUM RATINGS

$T_A = 25^\circ\text{C}$ , unless otherwise noted.

**Table 3.**

| Parameter  | Rating                        |
|--|-------------------------------|
| $V_{CC}$   | -0.3 V to +6 V                |
| $\overline{\text{RESET}}$ (ADM6320, ADM6321, ADM6322)                    | -0.3 V to +6 V                |
| All Other Pins   | -0.3 V to ( $V_{CC} + 0.3$ V) |
| Output Current ( $\overline{\text{RESET}}$ , $\overline{\text{RESET}}$ ) | 20 mA                         |
| Operating Temperature Range  | -40°C to +85°C                |
| Storage Temperature Range  | -65°C to +125°C               |
| $\theta_{JA}$ Thermal Impedance, SOT-23                                  | 270°C/W                       |
| Lead Temperature   |                               |
| Soldering (10 sec)   | 300°C                         |
| Vapor Phase (60 sec)   | 215°C                         |
| Infrared (15 sec)  | 220°C                         |

Stresses at or above those listed under Absolute Maximum Ratings may cause permanent damage to the product. This is a stress rating only; functional operation of the product at these or any other conditions above those indicated in the operational section of this specification is not implied. Operation beyond the maximum operating conditions for extended periods may affect product reliability.

### ESD CAUTION



**ESD (electrostatic discharge) sensitive device.** Charged devices and circuit boards can discharge without detection. Although this product features patented or proprietary protection circuitry, damage may occur on devices subjected to high energy ESD. Therefore, proper ESD precautions should be taken to avoid performance degradation or loss of functionality.

## PIN CONFIGURATIONS AND FUNCTION DESCRIPTIONS



Figure 3. ADM6316/ADM6320 Pin Configuration



Figure 5. ADM6319/ADM6322 Pin Configuration



Figure 4. ADM6318/ADM6321 Pin Configuration

Table 4. Pin Function Descriptions

| Pin No. | Mnemonic   | Description   |
|---------|--|---|
| 1       | RESET  | Active Low Reset Output. Asserted whenever $V_{CC}$ is below the reset threshold, $V_{TH}$ .<br>Push-Pull Output Stage for the ADM6316/ADM6318/ADM6319.<br>Open-Drain Output Stage for the ADM6320/ADM6321/ADM6322.   |
| 2       | GND  | Ground.   |
| 3       | $\overline{MR}$ (ADM6316/ADM6320)  | Manual Reset Input. This is an active low input that when forced low for at least 1 $\mu s$ , generates a reset. It features a 52 k $\Omega$ internal pull-up.  |
| 4       | RESET (ADM6318/ADM6319/ADM6321/ADM6322)<br>WDI (ADM6316/ADM6318/ADM6320/ADM6321) | Active High Push-Pull Reset Output.<br>Watchdog Input. Generates a reset if the logic level on the pin remains low or high for the duration of the watchdog timeout. The timer is cleared if a logic transition occurs on this pin or if a reset is generated. Leave this pin floating to disable the watchdog timer. |
| 5       | $\overline{MR}$ (ADM6319/ADM6322)<br>$V_{CC}$ (all models)                       | Manual Reset Input.<br>Power Supply Voltage Being Monitored.  |

### TYPICAL PERFORMANCE CHARACTERISTICS



Figure 6. Supply Current vs. Temperature (ADM6316/ADM6318/ADM6320/ADM6321)

04633-006



Figure 9. V<sub>CC</sub> Falling to Reset Propagation Delay vs. Temperature

04633-009



Figure 7. Supply Current vs. Supply Voltage

04633-007



Figure 10. Manual Reset to Reset Propagation Delay vs. Temperature (ADM6316/ADM6319/ADM6320/ADM6322)

04633-010



Figure 8. Normalized Reset Threshold vs. Temperature

04633-008



Figure 11. Normalized Reset Timeout Period vs. Temperature

04633-011



Figure 12. Normalized Watchdog Timeout Period vs. Temperature (ADM6316/ADM6318/ADM6320/ADM6321)



Figure 14. Manual Reset Minimum Pulse Width vs. Temperature (ADM6316/ADM6319/ADM6320/ADM6322)



Figure 13. Maximum V<sub>CC</sub> Transient Duration vs. Reset Threshold Overdrive



Figure 15. Watchdog Input Minimum Pulse Width vs. Temperature (ADM6316/ADM6318/ADM6320/ADM6321)



## CIRCUIT DESCRIPTION

The ADM6316/ADM6318/ADM6319/ADM6320/ADM6321/ADM6322 provide microprocessor supply voltage supervision by controlling the reset input of the microprocessor. Code execution errors are avoided during power-up, power-down, and brownout conditions by asserting a reset signal when the supply voltage is below a preset threshold and by allowing supply voltage stabilization with a fixed timeout reset pulse after the supply voltage rises above the threshold. In addition, problems with microprocessor code execution can be monitored and corrected with a watchdog timer (ADM6316/ADM6318/ADM6320/ADM6321). If the user detects a problem with the system's operation, a manual reset input is available (ADM6316/ADM6319/ADM6320/ADM6322) to reset the microprocessor, for example, by means of an external push button.

### RESET OUTPUT

The ADM6316 features an active low push-pull reset output, while the ADM6321/ADM6322 have active high push-pull reset outputs. The ADM6318/ADM6319 feature dual active low and active high push-pull reset outputs. For active low and active high outputs, the reset signal is guaranteed to be logic low and logic high, respectively, for  $V_{CC}$  down to 1 V.

The reset output is asserted when  $V_{CC}$  is below the reset threshold ( $V_{TH}$ ), when  $\overline{MR}$  is driven low, or when WDI is not serviced within the watchdog timeout period ( $t_{WD}$ ). Reset remains asserted for the duration of the reset active timeout period ( $t_{RP}$ ) after  $V_{CC}$  rises above the reset threshold, after  $\overline{MR}$  transitions from low to high, or after the watchdog timer times out. Figure 16 illustrates the behavior of the reset outputs.



Figure 16. Reset Timing Diagram

### OPEN-DRAIN RESET OUTPUT

The ADM6320/ADM6321/ADM6322 have an active low, open-drain reset output. This output structure requires an external pull-up resistor to connect the reset output to a voltage rail no higher than 6 V. The resistor must comply with the microprocessor's logic low and logic high voltage level requirements while supplying input current and leakage paths on the  $\overline{RESET}$  line. A 10 k $\Omega$  resistor is adequate in most situations.

### MANUAL RESET INPUT

The ADM6316/ADM6319/ADM6320/ADM6322 feature a manual reset input ( $\overline{MR}$ ), which when driven low, asserts the reset output. When  $\overline{MR}$  transitions from low to high, reset remains asserted for the duration of the reset active timeout period before deasserting. The  $\overline{MR}$  input has a 52 k $\Omega$ , internal pull-up so that the input is always high when unconnected. An external push-button switch can be connected between  $\overline{MR}$  and ground so that the user can generate a reset. Debounce circuitry for this purpose is integrated on chip. Noise immunity is provided on the  $\overline{MR}$  input, and fast, negative going transients of up to 100 ns (typical) are ignored. A 0.1  $\mu$ F capacitor between  $\overline{MR}$  and ground provides additional noise immunity.

### WATCHDOG INPUT

The ADM6316/ADM6318/ADM6320/ADM6321 feature a watchdog timer that monitors microprocessor activity. A timer circuit is cleared with every low-to-high or high-to-low logic transition on the watchdog input pin (WDI), which detects pulses as short as 50 ns. If the timer counts through the preset watchdog timeout period ( $t_{WD}$ ), reset is asserted. The microprocessor is required to toggle the WDI pin to avoid being reset. Failure of the microprocessor to toggle WDI within the timeout period, therefore, indicates a code execution error, and the reset pulse generated restarts the microprocessor in a known state.

As well as logic transitions on WDI, the watchdog timer is also cleared by a reset assertion due to an undervoltage condition on  $V_{CC}$  or due to  $\overline{MR}$  being pulled low. When reset is asserted, the watchdog timer is cleared and does not begin counting again until reset deasserts. The watchdog timer can be disabled by leaving WDI floating or by three-stating the WDI driver.



Figure 17. Watchdog Timing Diagram

## APPLICATIONS INFORMATION

### WATCHDOG INPUT CURRENT

To minimize watchdog input current (and minimize overall power consumption), leave WDI low for the majority of the watchdog timeout period. When driven high, WDI can draw as much as 160  $\mu$ A. Pulsing WDI low-to-high-to-low at a low duty cycle reduces the effect of the large input current. When WDI is unconnected, a window comparator disconnects the watchdog timer from the reset output circuitry so that reset is not asserted when the watchdog timer times out.

### NEGATIVE GOING $V_{CC}$ TRANSIENTS

To avoid unnecessary resets caused by fast power supply transients, the ADM6316/ADM6318/ADM6319/ADM6320/ADM6321/ADM6322 are equipped with glitch rejection circuitry. The typical performance characteristic in Figure 13 plots  $V_{CC}$  transient duration vs. the transient magnitude. The curves show combinations of transient magnitude and duration for which a reset is not generated for 4.63 V and 2.93 V reset threshold parts. For example, with the 2.93 V threshold, a transient that goes 100 mV below the threshold and lasts 8  $\mu$ s typically does not cause a reset, but if the transient is any larger in magnitude or duration, a reset is generated. An optional 0.1  $\mu$ F bypass capacitor mounted close to  $V_{CC}$  provides additional glitch rejection.

### ENSURING RESET VALID TO $V_{CC} = 0$ V

Both active low and active high reset outputs are guaranteed to be valid for  $V_{CC}$  as low as 1 V. However, by using an external resistor with push-pull configured reset outputs, valid outputs for  $V_{CC}$  as low as 0 V are possible. For an active low reset output, a resistor connected between  $\overline{\text{RESET}}$  and ground pulls the output low when it is unable to sink current. For the active high case, a resistor connected between  $\overline{\text{RESET}}$  and  $V_{CC}$  pulls the output high when it is unable to source current. A large resistance, such as 100 k $\Omega$ , must be used so that it does not overload the reset output when  $V_{CC}$  is above 1 V.



Figure 18. Ensuring Reset Valid to  $V_{CC} = 0$  V

### WATCHDOG SOFTWARE CONSIDERATIONS

In implementing the microprocessor's watchdog strobe code, quickly switching WDI low to high and then high to low (minimizing WDI high time) is desirable for current consumption reasons. However, a more effective way of using the watchdog function can be considered.

A low-to-high-to-low WDI pulse within a given subroutine prevents the watchdog from timing out. However, if the subroutine becomes stuck in an infinite loop, the watchdog cannot detect this because the subroutine continues to toggle WDI. A more effective coding scheme for detecting this error involves using a slightly longer watchdog timeout. In the program that calls the subroutine, WDI is set high. The subroutine sets WDI low when it is called. If the program executes without error, WDI is toggled high and low with every loop of the program. If the subroutine enters an infinite loop, WDI is kept low, the watchdog times out, and the microprocessor is reset (see Figure 19).



Figure 19. Watchdog Flow Diagram

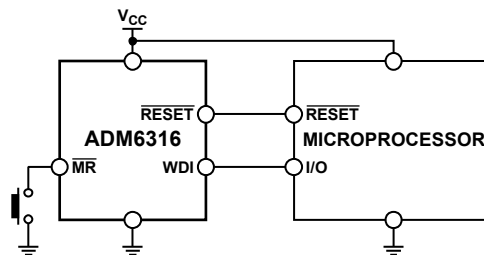

Figure 20. Typical Application Circuit

## DEVICE MODEL OPTIONS

The ADM6316/ADM6318/ADM6319/ADM6320/ADM6321/ADM6322 include many device options, however, not all options are released for sale. Released options called standard models and are listed in the Ordering Guide.

The [Watchdog Timers](#) page on the ADI website also shows a list of standard models. Contact a sales representative for information on nonstandard models and be aware that samples and production units have very long lead times.

**Table 5. Reset Voltage Threshold Options**

| Reset Threshold Number | $T_A = +25^\circ\text{C}$ |       |       | $T_A = -40^\circ\text{C to } +85^\circ\text{C}$ |       | Unit |
|------------------------|---------------------------|-------|-------|---|-------|------|
|                        | Min                       | Typ   | Max   | Min   | Max   |      |
| 50                     | 4.925                     | 5.000 | 5.075 | 4.875   | 5.125 | V    |
| 49                     | 4.827                     | 4.900 | 4.974 | 4.778   | 5.023 | V    |
| 48                     | 4.728                     | 4.800 | 4.872 | 4.680   | 4.920 | V    |
| 47                     | 4.630                     | 4.700 | 4.771 | 4.583   | 4.818 | V    |
| 46                     | 4.561                     | 4.630 | 4.699 | 4.514   | 4.746 | V    |
| 45                     | 4.433                     | 4.500 | 4.568 | 4.388   | 4.613 | V    |
| 44                     | 4.314                     | 4.390 | 4.446 | 4.270   | 4.490 | V    |
| 43                     | 4.236                     | 4.300 | 4.365 | 4.193   | 4.408 | V    |
| 42                     | 4.137                     | 4.200 | 4.263 | 4.095   | 4.305 | V    |
| 41                     | 4.039                     | 4.100 | 4.162 | 3.998   | 4.203 | V    |
| 40                     | 3.940                     | 4.00  | 4.060 | 3.900   | 4.100 | V    |
| 39                     | 3.842                     | 3.900 | 3.959 | 3.803   | 3.998 | V    |
| 38                     | 3.743                     | 3.800 | 3.857 | 3.705   | 3.895 | V    |
| 37                     | 3.645                     | 3.700 | 3.756 | 3.608   | 3.793 | V    |
| 36                     | 3.546                     | 3.600 | 3.654 | 3.510   | 3.690 | V    |
| 35                     | 3.448                     | 3.500 | 3.553 | 3.413   | 3.588 | V    |
| 34                     | 3.349                     | 3.400 | 3.451 | 3.315   | 3.485 | V    |
| 33                     | 3.251                     | 3.300 | 3.350 | 3.218   | 3.383 | V    |
| 32                     | 3.152                     | 3.200 | 3.248 | 3.120   | 3.280 | V    |
| 31                     | 3.034                     | 3.080 | 3.126 | 3.003   | 3.157 | V    |
| 30                     | 2.955                     | 3.000 | 3.045 | 2.925   | 3.075 | V    |
| 29                     | 2.886                     | 2.930 | 2.974 | 2.857   | 3.000 | V    |
| 28                     | 2.758                     | 2.800 | 2.842 | 2.730   | 2.870 | V    |
| 27                     | 2.660                     | 2.700 | 2.741 | 2.633   | 2.768 | V    |
| 26                     | 2.591                     | 2.630 | 2.669 | 2.564   | 2.696 | V    |
| 25                     | 2.463                     | 2.500 | 2.538 | 2.438   | 2.563 | V    |

**Table 6. Reset Timeout Options**

| Suffix | Min  | Typ  | Max  | Unit |
|--------|------|------|------|------|
| A      | 1    | 1.6  | 2    | ms   |
| B      | 20   | 30   | 40   | ms   |
| C      | 140  | 200  | 280  | ms   |
| D      | 1.12 | 1.60 | 2.24 | sec  |

**Table 7. Watchdog Timer Options**

| Suffix | Min  | Typ  | Max  | Unit |
|--------|------|------|------|------|
| W      | 4.3  | 6.3  | 9.3  | ms   |
| X      | 71   | 102  | 153  | ms   |
| Y      | 1.12 | 1.6  | 2.24 | sec  |
| Z      | 17.9 | 25.6 | 38.4 | sec  |



Figure 21. Ordering Code Structure (Modified Diagram)

04533-024

### OUTLINE DIMENSIONS



COMPLIANT TO JEDEC STANDARDS MO-178-AA

Figure 22. 5-Lead Small Outline Transistor Package [SOT-23] (RJ-5)

Dimensions shown in millimeters

11-91-2010-A

### ORDERING GUIDE

| Model <sup>1,2,3</sup> | Reset Voltage Threshold (V) | Minimum Reset Timeout (ms) | Typical Watchdog Timeout (sec) <sup>4</sup> | Temperature Range | Package Description | Package Option | Ordering Quantity | Marking Code |
|------------------------|-----------------------------|----------------------------|---|-------------------|---------------------|----------------|-------------------|--------------|
| ADM6316AY27ARJZ-R7     | 2.7                         | 1                          | 1.6   | -40°C to +85°C    | 5-Lead SOT-23       | RJ-5           | 3,000             | M7Q          |
| ADM6316AY29ARJZ-R7     | 2.93                        | 1                          | 1.6   | -40°C to +85°C    | 5-Lead SOT-23       | RJ-5           | 3,000             | M7Q          |
| ADM6316AZ29ARJZ-R7     | 2.93                        | 1                          | 25.6  | -40°C to +85°C    | 5-Lead SOT-23       | RJ-5           | 3,000             | M7Q          |
| ADM6316BX30ARJZ-R7     | 3                           | 20                         | 0.102                                       | -40°C to +85°C    | 5-Lead SOT-23       | RJ-5           | 3,000             | M7Q          |
| ADM6316BX46ARJZ-R7     | 4.63                        | 20                         | 0.102                                       | -40°C to +85°C    | 5-Lead SOT-23       | RJ-5           | 3,000             | M7Q          |
| ADM6316CW25ARJZ-R7     | 2.5                         | 140                        | 0.0063                                      | -40°C to +85°C    | 5-Lead SOT-23       | RJ-5           | 3,000             | M7Q          |
| ADM6316CY26ARJZ-R7     | 2.63                        | 140                        | 1.6   | -40°C to +85°C    | 5-Lead SOT-23       | RJ-5           | 3,000             | M7Q          |
| ADM6316CY29ARJZ-R7     | 2.93                        | 140                        | 1.6   | -40°C to +85°C    | 5-Lead SOT-23       | RJ-5           | 3,000             | M7Q          |
| ADM6316CY46ARJZ-R7     | 4.63                        | 140                        | 1.6   | -40°C to +85°C    | 5-Lead SOT-23       | RJ-5           | 3,000             | M7Q          |
| ADM6316DZ26ARJ-RL7     | 2.63                        | 1120                       | 25.6  | -40°C to +85°C    | 5-Lead SOT-23       | RJ-5           | 3,000             | N00          |
| ADM6316DZ26ARJZ-R7     | 2.63                        | 1120                       | 25.6  | -40°C to +85°C    | 5-Lead SOT-23       | RJ-5           | 3,000             | M7Q          |
| ADM6316DZ31ARJZ-R7     | 3.08                        | 1120                       | 25.6  | -40°C to +85°C    | 5-Lead SOT-23       | RJ-5           | 3,000             | M7Q          |
| ADM6318BX49ARJZ-R7     | 4.9                         | 20                         | 0.102                                       | -40°C to +85°C    | 5-Lead SOT-23       | RJ-5           | 3,000             | M9N          |
| ADM6318CY29ARJZ-R7     | 2.93                        | 140                        | 1.6   | -40°C to +85°C    | 5-Lead SOT-23       | RJ-5           | 3,000             | M4Q          |
| ADM6318CY46ARJ-RL7     | 4.63                        | 140                        | 1.6   | -40°C to +85°C    | 5-Lead SOT-23       | RJ-5           | 3,000             | M4Q          |
| ADM6318CY46ARJZ-R7     | 4.63                        | 140                        | 1.6   | -40°C to +85°C    | 5-Lead SOT-23       | RJ-5           | 3,000             | N02          |
| ADM6318CZ28ARJZ-R7     | 2.8                         | 140                        | 25.6  | -40°C to +85°C    | 5-Lead SOT-23       | RJ-5           | 3,000             | M4Q          |
| ADM6319B25ARJZ-R7      | 2.5                         | 20                         | N/A   | -40°C to +85°C    | 5-Lead SOT-23       | RJ-5           | 3,000             | M4Q          |
| ADM6319B31ARJZ-RL7     | 3.08                        | 20                         | N/A   | -40°C to +85°C    | 5-Lead SOT-23       | RJ-5           | 3,000             | N05          |
| ADM6319C29ARJZ-RL7     | 2.93                        | 140                        | N/A   | -40°C to +85°C    | 5-Lead SOT-23       | RJ-5           | 3,000             | N05          |
| ADM6319C46ARJZ-RL7     | 4.63                        | 140                        | N/A   | -40°C to +85°C    | 5-Lead SOT-23       | RJ-5           | 3,000             | N05          |
| ADM6320BX33ARJZ-R7     | 3.3                         | 20                         | 0.102                                       | -40°C to +85°C    | 5-Lead SOT-23       | RJ-5           | 3,000             | N05          |
| ADM6320BX45ARJZ-R7     | 4.5                         | 20                         | 0.102                                       | -40°C to +85°C    | 5-Lead SOT-23       | RJ-5           | 3,000             | N0T          |
| ADM6320CX29ARJZ-R7     | 2.93                        | 140                        | 0.102                                       | -40°C to +85°C    | 5-Lead SOT-23       | RJ-5           | 3,000             | N0T          |
| ADM6320CY29ARJ-RL7     | 2.93                        | 140                        | 1.6   | -40°C to +85°C    | 5-Lead SOT-23       | RJ-5           | 3,000             | N0T          |
| ADM6320CY29ARJZ-R7     | 2.93                        | 140                        | 1.6   | -40°C to +85°C    | 5-Lead SOT-23       | RJ-5           | 3,000             | N04          |

| Model <sup>1,2,3</sup> | Reset Voltage Threshold (V) | Minimum Reset Timeout (ms) | Typical Watchdog Timeout (sec) <sup>4</sup> | Temperature Range | Package Description | Package Option | Ordering Quantity | Marking Code |
|------------------------|-----------------------------|----------------------------|---|-------------------|---------------------|----------------|-------------------|--------------|
| ADM6320CY31ARJZ-R7     | 3.08                        | 140                        | 1.6   | -40°C to +85°C    | 5-Lead SOT-23       | RJ-5           | 3,000             | N0T          |
| ADM6320CY46ARJZ-R7     | 4.63                        | 140                        | 1.6   | -40°C to +85°C    | 5-Lead SOT-23       | RJ-5           | 3,000             | N0T          |
| ADM6320CZ27ARJZ-R7     | 2.7                         | 140                        | 25.6  | -40°C to +85°C    | 5-Lead SOT-23       | RJ-5           | 3,000             | N0T          |
| ADM6320CZ29ARJ-RL7     | 2.93                        | 140                        | 25.6  | -40°C to +85°C    | 5-Lead SOT-23       | RJ-5           | 3,000             | N0T          |
| ADM6320CZ29ARJZ-R7     | 2.93                        | 140                        | 25.6  | -40°C to +85°C    | 5-Lead SOT-23       | RJ-5           | 3,000             | N04          |
| ADM6321AX29ARJZ-R7     | 2.93                        | 1                          | 0.102                                       | -40°C to +85°C    | 5-Lead SOT-23       | RJ-5           | 3,000             | N0T          |
| ADM6321AY30ARJZ-R7     | 3                           | 1                          | 1.6   | -40°C to +85°C    | 5-Lead SOT-23       | RJ-5           | 3,000             | M8L          |
| ADM6321AY31ARJZ-R7     | 3.08                        | 1                          | 1.6   | -40°C to +85°C    | 5-Lead SOT-23       | RJ-5           | 3,000             | M8L          |
| ADM6321AY43ARJZ-R7     | 4.3                         | 1                          | 1.6   | -40°C to +85°C    | 5-Lead SOT-23       | RJ-5           | 3,000             | M8L          |
| ADM6321BZ25ARJZ-R7     | 2.5                         | 20                         | 25.6  | -40°C to +85°C    | 5-Lead SOT-23       | RJ-5           | 3,000             | M8L          |
| ADM6321CY46ARJZ-R7     | 4.63                        | 140                        | 1.6   | -40°C to +85°C    | 5-Lead SOT-23       | RJ-5           | 3,000             | M8L          |
| ADM6322C29ARJZ-R7      | 2.93                        | 140                        | N/A   | -40°C to +85°C    | 5-Lead SOT-23       | RJ-5           | 3,000             | M8L          |
| ADM6322C46ARJZ-RL7     | 4.63                        | 140                        | N/A   | -40°C to +85°C    | 5-Lead SOT-23       | RJ-5           | 3,000             | M8J          |
|                        |                             |                            |   |                   |                     |                |                   | M8J          |

<sup>1</sup> Z = RoHS Compliant Part.

<sup>2</sup> The ADM6316/ADM6318/ADM6319/ADM6320/ADM6321/ADM6322 include many device options, however, not all options are released for sale. Released options called standard models and are listed in the Ordering Guide. The [Watchdog Timers](#) page on the ADI website also shows a list of standard models. Contact a sales representative for information on nonstandard models and be aware that samples and production units have very long lead times.

<sup>3</sup> If ordering nonstandard models, complete the ordering code (see Figure 21) by inserting the reset voltage threshold, reset timeout, and watchdog timer (ADM6316/ADM6318/ADM6320/ADM6321) suffixes from Table 5 to Table 7. No watchdog timeout is available for ADM6319/ADM6322.

<sup>4</sup> N/A means not applicable.

Компания «Life Electronics» занимается поставками электронных компонентов импортного и отечественного производства от производителей и со складов крупных дистрибьюторов Европы, Америки и Азии.

С конца 2013 года компания активно расширяет линейку поставок компонентов по направлению коаксиальный кабель, кварцевые генераторы и конденсаторы (керамические, пленочные, электролитические), за счёт заключения дистрибьюторских договоров

Мы предлагаем:

- Конкурентоспособные цены и скидки постоянным клиентам.
- Специальные условия для постоянных клиентов.
- Подбор аналогов.
- Поставку компонентов в любых объемах, удовлетворяющих вашим потребностям.
- Приемлемые сроки поставки, возможна ускоренная поставка.
- Доставку товара в любую точку России и стран СНГ.
- Комплексную поставку.
- Работу по проектам и поставку образцов.
- Формирование склада под заказчика.
- Сертификаты соответствия на поставляемую продукцию (по желанию клиента).
- Тестирование поставляемой продукции.
- Поставку компонентов, требующих военную и космическую приемку.
- Входной контроль качества.
- Наличие сертификата ISO.

В составе нашей компании организован Конструкторский отдел, призванный помогать разработчикам, и инженерам.

Конструкторский отдел помогает осуществить:

- Регистрацию проекта у производителя компонентов.
- Техническую поддержку проекта.
- Защиту от снятия компонента с производства.
- Оценку стоимости проекта по компонентам.
- Изготовление тестовой платы монтаж и пусконаладочные работы.



Тел: +7 (812) 336 43 04 (многоканальный)

Email: [org@lifeelectronics.ru](mailto:org@lifeelectronics.ru)