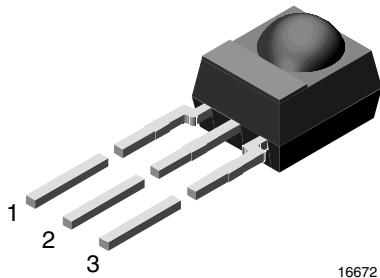


IR Receiver Modules for Data Transmission



16672

MECHANICAL DATA

Pinning for TSDP341.., TSDP343..:

 1 = OUT, 2 = GND, 3 = V_S

FEATURES

- Very low supply current
- Continuous data rates up to 7777 bps
- Range up to 32 m
- Photo detector and preamplifier in one package
- Internal filter tuned to 38.4 kHz for 4800 bps or 57.6 kHz for 9600 bps
- Shielding against EMI
- Supply voltage: 2.5 V to 5.5 V
- Immunity against ambient light
- Insensitive to supply voltage ripple and noise
- Material categorization: For definitions of compliance please see www.vishay.com/doc?99912



DESCRIPTION

These products are miniaturized receivers for low speed infrared data transmission. A PIN diode and a preamplifier are assembled on a lead frame, the epoxy package contains an IR filter.

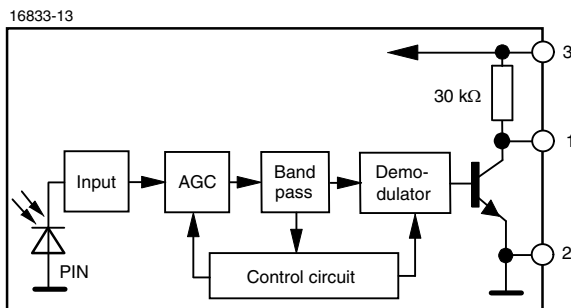
The demodulated output can be directly connected to a UART or a microprocessor. The TSDP34138 may be used for continuous reception of data according to RS-232 at 4800 bps in noise free environments. Higher data rate RS-232 may require data monitoring of gain levels. Non RS-232 codings may be used to achieve continuous average data rates up to 7800 bps in noisy ambients.

This component has not been qualified according to automotive specifications.

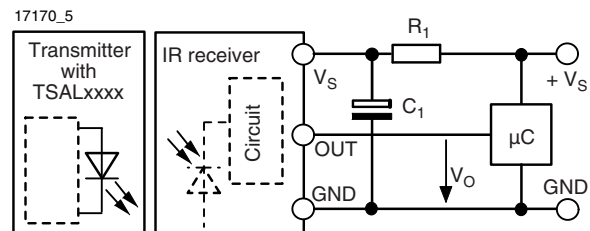
PARTS TABLE

AGC		AGC1 FOR LOW NOISE ENVIRONMENTS	AGC3 FOR NOISY ENVIRONMENTS
Carrier frequency	38.4 kHz	TSDP34138	TSDP34338
	57.6 kHz	TSDP34156	TSDP34356
Package	Mold		
Pinning	1 = OUT, 2 = GND, 3 = V_S		1 = OUT, 2 = GND, 3 = V_S
Dimensions (mm)	6.0 W x 6.95 H x 5.6 D		
Mounting	Leaded		
Application	Data transmission		

BLOCK DIAGRAM



APPLICATION CIRCUIT



R_1 and C_1 are recommended for protection against EOS. Components should be in the range of $33 \Omega < R_1 < 1 \text{ k}\Omega$, $C_1 > 0.1 \mu\text{F}$.

ABSOLUTE MAXIMUM RATINGS				
PARAMETER	TEST CONDITION	SYMBOL	VALUE	UNIT
Supply voltage		V_S	-0.3 to +6	V
Supply current		I_S	3	mA
Output voltage		V_O	-0.3 to ($V_S + 0.3$)	V
Output current		I_O	5	mA
Junction temperature		T_j	100	°C
Storage temperature range		T_{stg}	-25 to +85	°C
Operating temperature range		T_{amb}	-25 to +85	°C
Power consumption	$T_{amb} \leq 85\text{ °C}$	P_{tot}	10	mW
Soldering temperature	$t \leq 10\text{ s}$, 1 mm from case	T_{sd}	260	°C

Note

- Stresses beyond those listed under “Absolute Maximum Ratings” may cause permanent damage to the device. This is a stress rating only and functional operation of the device at these or any other conditions beyond those indicated in the operational sections of this specification is not implied. Exposure to absolute maximum rating conditions for extended periods may affect the device reliability.

ELECTRICAL AND OPTICAL CHARACTERISTICS ($T_{amb} = 25\text{ °C}$, unless otherwise specified)						
PARAMETER	TEST CONDITION	SYMBOL	MIN.	TYP.	MAX.	UNIT
Supply current	$E_v = 0$, $V_S = 3.3\text{ V}$	I_{SD}	0.27	0.35	0.45	mA
	$E_v = 40\text{ klx}$, sunlight	I_{SH}		0.45		mA
Supply voltage		V_S	2.5		5.5	V
Transmission distance	$E_v = 0$, test signal see fig. 1, IR diode TSAL6200, $I_F = 150\text{ mA}$	d		35		m
Output voltage low	$I_{OSL} = 0.5\text{ mA}$, $E_e = 0.7\text{ mW/m}^2$, test signal see fig. 1	V_{OSL}			100	mV
Minimum irradiance	Pulse width tolerance: $t_{pi} - 1/f_0 < t_{po} < t_{pi} + 4/f_0$, test signal see fig. 1	$E_e\text{ min.}$		0.15	0.30	mW/m^2
Maximum irradiance	$t_{pi} - 1/f_0 < t_{po} < t_{pi} + 4/f_0$, test signal see fig. 1	$E_e\text{ max.}$	30			W/m^2
Directivity	Angle of half transmission distance	$\phi_{1/2}$		± 45		deg

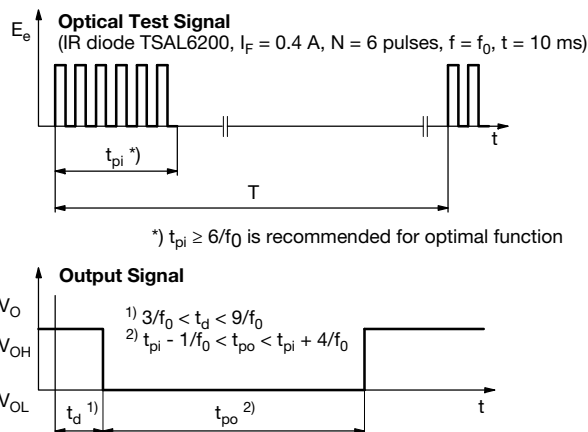
TYPICAL CHARACTERISTICS ($T_{amb} = 25\text{ °C}$, unless otherwise specified)


Fig. 1 - Output Active Low

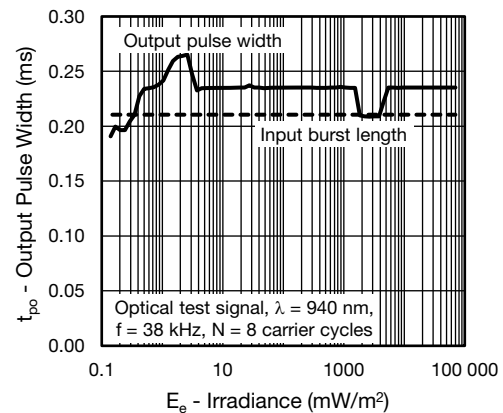


Fig. 2 - Pulse Length and Sensitivity in Dark Ambient

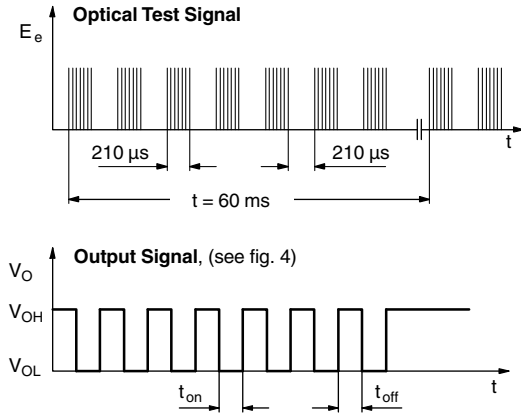


Fig. 3 - Output Function

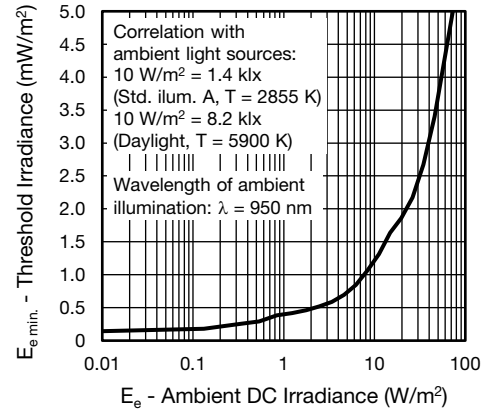


Fig. 6 - Sensitivity in Bright Ambient

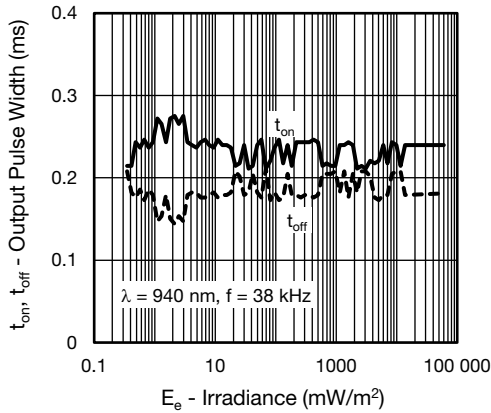


Fig. 4 - Output Pulse Diagram

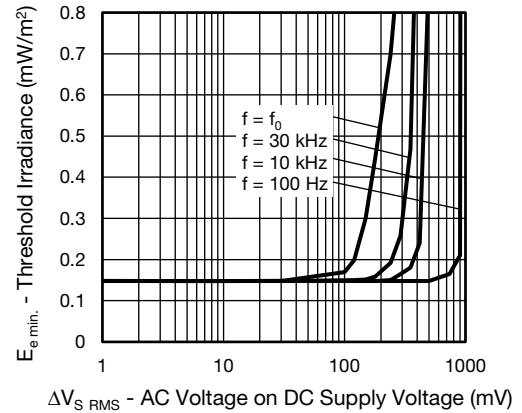


Fig. 7 - Sensitivity vs. Supply Voltage Disturbances

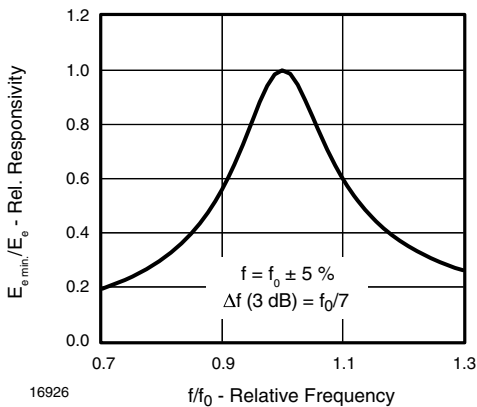


Fig. 5 - Frequency Dependence of Responsivity

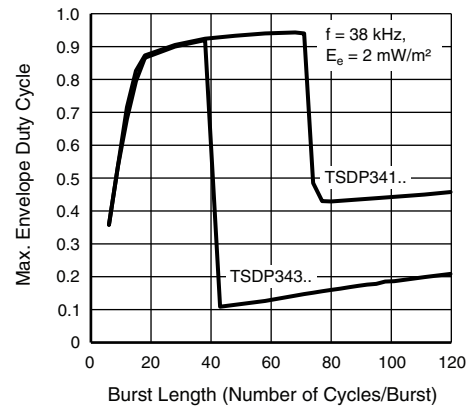


Fig. 8 - Maximum Envelope Duty Cycle vs. Burst Length



Fig. 9 - Sensitivity vs. Ambient Temperature

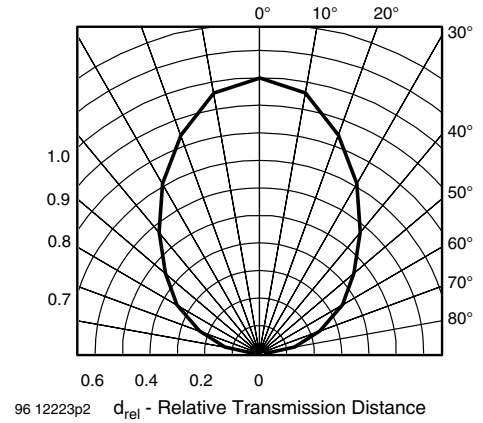


Fig. 11 - Horizontal Directivity



Fig. 10 - Relative Spectral Sensitivity vs. Wavelength

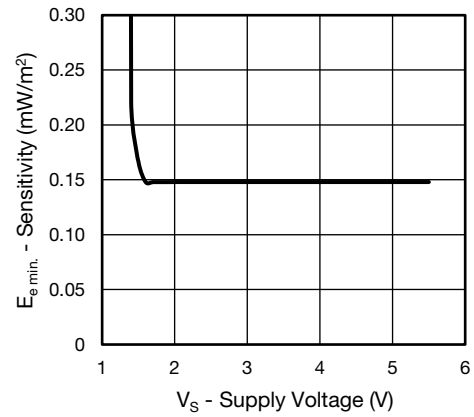


Fig. 12 - Sensitivity vs. Supply Voltage

SUITABLE DATA FORMAT

These receivers are designed to suppress spurious output pulses due to noise or optical disturbances. The devices can distinguish data signals from noise due to differences in frequency, burst length, and envelope duty cycle. For optimum sensitivity, the data's modulation frequency should be close to the device's band-pass center frequency (e.g. 38.4 kHz) and fulfill the conditions in the table below.

When a data signal is applied to the receiver in the presence of noise, the sensitivity of the receiver is automatically reduced by the AGC to insure that no spurious pulses are present at the receiver's output. Some examples of noise which is suppressed:

- DC light (e.g. from tungsten bulbs sunlight)
- Continuous signals at any frequency
- Strongly or weakly modulated patterns from fluorescent lamps with electronic ballasts (see fig. 13 or fig. 14).

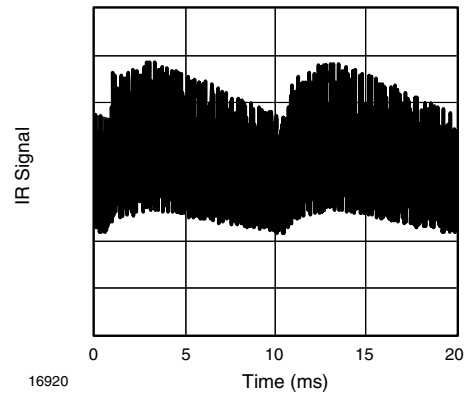


Fig. 13 - IR Disturbance from Fluorescent Lamp with Low Modulation

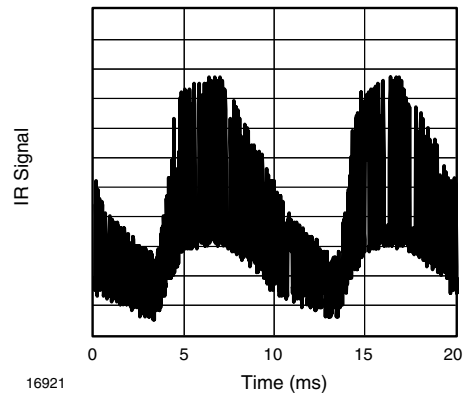


Fig. 14 - IR Disturbance from Fluorescent Lamp with High Modulation

	TSDP341..	TSDP343..
Minimum burst length	6 cycles/burst	6 cycles/burst
After each burst of length A gap time is required of	6 to 70 cycles ≥ 7 cycles	6 to 35 cycles ≥ 7 cycles
For bursts greater than a minimum gap time in the data stream is needed of	70 cycles > 1.2 x burst length	35 cycles > 6 x burst length
Maximum number of continuous short bursts/second	3000	3000
Suppression of interference from fluorescent lamps	Mildly modulated noise patterns are suppressed (fig. 13)	Strongly modulated noise patterns are suppressed (fig. 14)



PACKAGE DIMENSIONS in millimeters



Drawing-No.: 6.550-5169.01-4
 Issue: 9; 03.11.10
 13655



Disclaimer

ALL PRODUCT, PRODUCT SPECIFICATIONS AND DATA ARE SUBJECT TO CHANGE WITHOUT NOTICE TO IMPROVE RELIABILITY, FUNCTION OR DESIGN OR OTHERWISE.

Vishay Intertechnology, Inc., its affiliates, agents, and employees, and all persons acting on its or their behalf (collectively, "Vishay"), disclaim any and all liability for any errors, inaccuracies or incompleteness contained in any datasheet or in any other disclosure relating to any product.

Vishay makes no warranty, representation or guarantee regarding the suitability of the products for any particular purpose or the continuing production of any product. To the maximum extent permitted by applicable law, Vishay disclaims (i) any and all liability arising out of the application or use of any product, (ii) any and all liability, including without limitation special, consequential or incidental damages, and (iii) any and all implied warranties, including warranties of fitness for particular purpose, non-infringement and merchantability.

Statements regarding the suitability of products for certain types of applications are based on Vishay's knowledge of typical requirements that are often placed on Vishay products in generic applications. Such statements are not binding statements about the suitability of products for a particular application. It is the customer's responsibility to validate that a particular product with the properties described in the product specification is suitable for use in a particular application. Parameters provided in datasheets and/or specifications may vary in different applications and performance may vary over time. All operating parameters, including typical parameters, must be validated for each customer application by the customer's technical experts. Product specifications do not expand or otherwise modify Vishay's terms and conditions of purchase, including but not limited to the warranty expressed therein.

Except as expressly indicated in writing, Vishay products are not designed for use in medical, life-saving, or life-sustaining applications or for any other application in which the failure of the Vishay product could result in personal injury or death. Customers using or selling Vishay products not expressly indicated for use in such applications do so at their own risk. Please contact authorized Vishay personnel to obtain written terms and conditions regarding products designed for such applications.

No license, express or implied, by estoppel or otherwise, to any intellectual property rights is granted by this document or by any conduct of Vishay. Product names and markings noted herein may be trademarks of their respective owners.

Material Category Policy

Vishay Intertechnology, Inc. hereby certifies that all its products that are identified as RoHS-Compliant fulfill the definitions and restrictions defined under Directive 2011/65/EU of The European Parliament and of the Council of June 8, 2011 on the restriction of the use of certain hazardous substances in electrical and electronic equipment (EEE) - recast, unless otherwise specified as non-compliant.

Please note that some Vishay documentation may still make reference to RoHS Directive 2002/95/EC. We confirm that all the products identified as being compliant to Directive 2002/95/EC conform to Directive 2011/65/EU.

Vishay Intertechnology, Inc. hereby certifies that all its products that are identified as Halogen-Free follow Halogen-Free requirements as per JEDEC JS709A standards. Please note that some Vishay documentation may still make reference to the IEC 61249-2-21 definition. We confirm that all the products identified as being compliant to IEC 61249-2-21 conform to JEDEC JS709A standards.

Компания «Life Electronics» занимается поставками электронных компонентов импортного и отечественного производства от производителей и со складов крупных дистрибьюторов Европы, Америки и Азии.

С конца 2013 года компания активно расширяет линейку поставок компонентов по направлению коаксиальный кабель, кварцевые генераторы и конденсаторы (керамические, пленочные, электролитические), за счёт заключения дистрибьюторских договоров

Мы предлагаем:

- Конкуренспособные цены и скидки постоянным клиентам.
- Специальные условия для постоянных клиентов.
- Подбор аналогов.
- Поставку компонентов в любых объемах, удовлетворяющих вашим потребностям.
- Приемлемые сроки поставки, возможна ускоренная поставка.
- Доставку товара в любую точку России и стран СНГ.
- Комплексную поставку.
- Работу по проектам и поставку образцов.
- Формирование склада под заказчика.
- Сертификаты соответствия на поставляемую продукцию (по желанию клиента).
- Тестирование поставляемой продукции.
- Поставку компонентов, требующих военную и космическую приемку.
- Входной контроль качества.
- Наличие сертификата ISO.

В составе нашей компании организован Конструкторский отдел, призванный помогать разработчикам, и инженерам.

Конструкторский отдел помогает осуществить:

- Регистрацию проекта у производителя компонентов.
- Техническую поддержку проекта.
- Защиту от снятия компонента с производства.
- Оценку стоимости проекта по компонентам.
- Изготовление тестовой платы монтаж и пусконаладочные работы.



Тел: +7 (812) 336 43 04 (многоканальный)
Email: org@lifeelectronics.ru