

# RSAN SERIES

## Multipurpose Single-Phase Filter Compatible with High-Voltage Pulse



### FEATURES

- Amorphous core is used as the common mode coil core for the RSEN series, which helps prevent device error.
- Self-tightening screws and an open/close type cover make wiring work easier.
- Optional low-leakage current characteristic type and DIN rail installation compatible type are also available.
- Compliant with RoHS directives.

### SAFETY STANDARDS

|                |                             |
|----------------|-----------------------------|
| UL1283         | File No. E62388             |
| CSA C22.2 No.8 | File No. 208777             |
| EN60939        | Licence Ref. No. SE/07115-2 |

### PRODUCT IDENTIFICATION



### CIRCUIT DIAGRAMS

RSAN-2 \*\*\*  
RSAN-2 \*\*\* D



RSAN-2 \*\*\* L

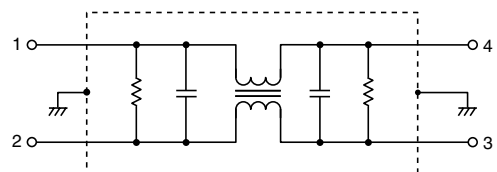

• Conformity to RoHS Directive: This means that, in conformity with EU Directive 2002/95/EC, lead, cadmium, mercury, hexavalent chromium, and specific bromine-based flame retardants, PBB and PBDE, have not been used, except for exempted applications.

• All specifications are subject to change without notice.

## ELECTRICAL CHARACTERISTICS

| Part No.  | Rated voltage (AC/DC) | Rated current (AC/DC) | Withstand voltage                           | Insulation resistance                | Leakage current              | Operating temperature range | With derating over | DC resistance (mΩ) | Attenuation frequency range (MHz) |           |                   |
|-----------|-----------------------|-----------------------|---|--------------------------------------|------------------------------|-----------------------------|--------------------|--------------------|-----------------------------------|-----------|-------------------|
|           |                       |                       |   |                                      |                              |                             |                    |                    | Common mode                       |           | Differential mode |
|           |                       |                       |   |                                      |                              |                             |                    |                    | at 25dB                           |           | at 25dB           |
| RSAN-2003 | 250V                  | 3A                    | AC.2500V<br>60s<br>[Between line to ground] | 100MΩ<br>min.<br>[DC.500V/<br>1min.] | 1.0mA<br>max.<br>[250V/60Hz] | -25 to +85°C                | 55°C               | 250 max.           | 0.1 to 10                         | 0.1 to 30 |                   |
| RSAN-2006 |                       | 6A                    |   |                                      |                              |                             |                    | 110 max.           | 0.1 to 10                         | 0.1 to 30 |                   |
| RSAN-2010 |                       | 10A                   |   |                                      |                              |                             |                    | 40 max.            | 0.3 to 10                         | 0.2 to 30 |                   |
| RSAN-2016 |                       | 16A                   |   |                                      |                              |                             |                    | 20 max.            | 0.8 to 10                         | 0.3 to 30 |                   |
| RSAN-2020 |                       | 20A                   |   |                                      |                              |                             |                    | 10 max.            | 1 to 10                           | 0.3 to 30 |                   |
| RSAN-2030 |                       | 30A                   |   |                                      |                              |                             |                    | 6 max.             | 2 to 10                           | 0.4 to 30 |                   |
| RSAN-2040 |                       | 40A                   |   |                                      |                              |                             |                    | 6 max.             | 0.8 to 10                         | 0.1 to 30 |                   |
| RSAN-2050 |                       | 50A                   |   |                                      |                              |                             |                    | 4 max.             | 1 to 10                           | 0.1 to 30 |                   |
| RSAN-2060 |                       | 60A                   |   |                                      |                              |                             |                    | 3 max.             | 2 to 10                           | 0.2 to 30 |                   |

| Part No.   | Rated voltage (AC/DC) | Rated current (AC/DC) | Withstand voltage                           | Insulation resistance                | Leakage current               | Operating temperature range | With derating over | DC resistance (mΩ) | Attenuation frequency range (MHz) |           |                   |
|------------|-----------------------|-----------------------|---|--------------------------------------|-------------------------------|-----------------------------|--------------------|--------------------|-----------------------------------|-----------|-------------------|
|            |                       |                       |   |                                      |                               |                             |                    |                    | Common mode                       |           | Differential mode |
|            |                       |                       |   |                                      |                               |                             |                    |                    | at 20dB                           | at 10dB   | at 25dB           |
| RSAN-2003L | 250V                  | 3A                    | AC.2500V<br>60s<br>[Between line to ground] | 100MΩ<br>min.<br>[DC.500V/<br>1min.] | 10 μ A<br>max.<br>[250V/60Hz] | -25 to +85°C                | 55°C               | 250 max.           | 0.1 to 3                          | -         | 0.1 to 30         |
| RSAN-2006L |                       | 6A                    |   |                                      |                               |                             |                    | 110 max.           | 0.1 to 3                          | -         | 0.1 to 30         |
| RSAN-2010L |                       | 10A                   |   |                                      |                               |                             |                    | 40 max.            | 0.5 to 6                          | -         | 0.2 to 30         |
| RSAN-2016L |                       | 16A                   |   |                                      |                               |                             |                    | 20 max.            | -                                 | 0.3 to 10 | 0.3 to 30         |
| RSAN-2020L |                       | 20A                   |   |                                      |                               |                             |                    | 10 max.            | -                                 | 0.5 to 8  | 0.3 to 30         |
| RSAN-2030L |                       | 30A                   |   |                                      |                               |                             |                    | 6 max.             | -                                 | 3 to 20   | 0.4 to 30         |

## DERATINGS



■ SHAPES AND DIMENSIONS

RSAN-2003/2006/2010/2016/2020/2030

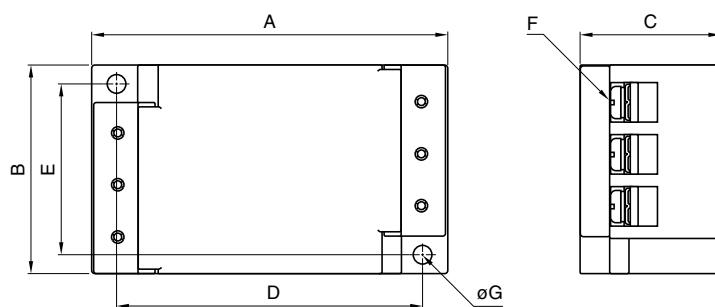

RSAN-2040/2050/2060

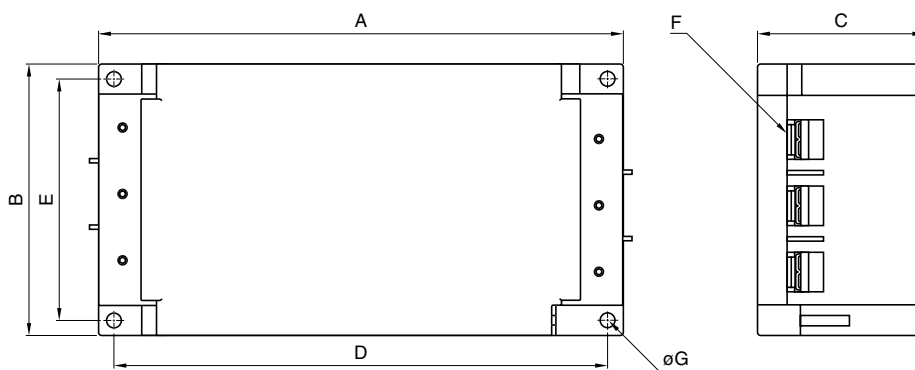

Dimensions in mm

| Part No.  | A   | B  | C  | D   | E  | F  | $\phi$ G | Recommended clamping torque |
|-----------|-----|----|----|-----|----|----|----------|-----------------------------|
| RSAN-2003 | 87  | 52 | 35 | 75  | 43 | M4 | 4.5      | 1.27N · m                   |
| RSAN-2006 |     |    |    |     |    |    |          |                             |
| RSAN-2010 |     |    |    |     |    |    |          |                             |
| RSAN-2016 |     |    |    |     |    |    |          |                             |
| RSAN-2020 |     |    |    |     |    |    |          |                             |
| RSAN-2030 | 170 | 90 | 54 | 160 | 80 | M5 | 4.5      | 2.5N · m                    |
| RSAN-2040 |     |    |    |     |    |    |          |                             |
| RSAN-2050 |     |    |    |     |    |    |          |                             |
| RSAN-2060 |     |    |    |     |    |    |          |                             |

RSAN-2003D/2006D/2010D/2016D/2020D/2030D



Dimensions in mm

| Part No.   | A  | B  | C  | D  | E  | F  | G  | H  | I   | J   | K   |
|------------|----|----|----|----|----|----|----|----|-----|-----|-----|
| RSAN-2003D | 87 | 52 | 35 | 75 | 43 | M4 | M4 | 98 | 8.4 | 8.5 | 3.5 |
| RSAN-2006D |    |    |    |    |    |    |    |    |     |     |     |
| RSAN-2010D |    |    |    |    |    |    |    |    |     |     |     |
| RSAN-2016D |    |    |    |    |    |    |    |    |     |     |     |
| RSAN-2020D |    |    |    |    |    |    |    |    |     |     |     |
| RSAN-2030D |    |    |    |    |    |    |    |    |     |     |     |

**ATTENUATION vs. FREQUENCY CHARACTERISTICS**

RSAN-2003

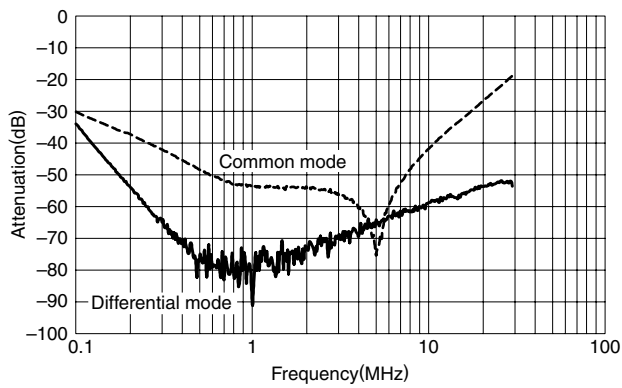

RSAN-2006

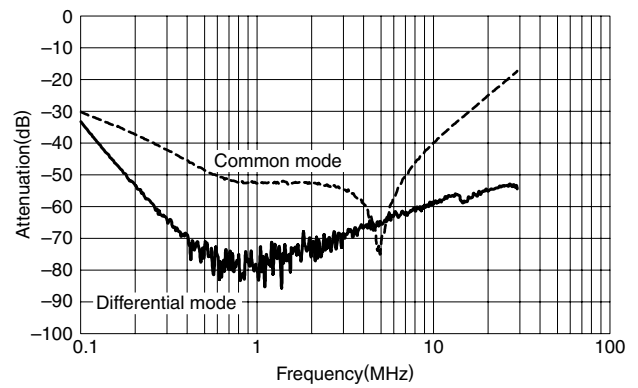

RSAN-2010

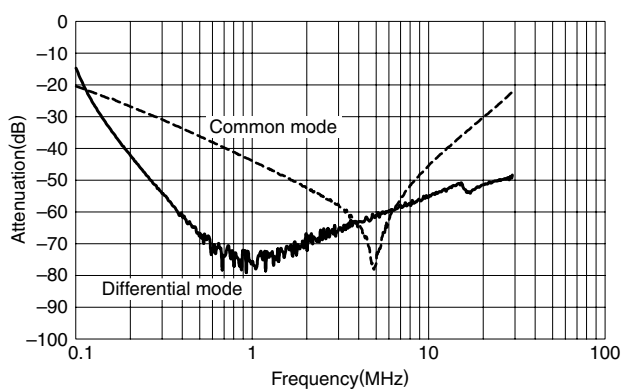

RSAN-2016

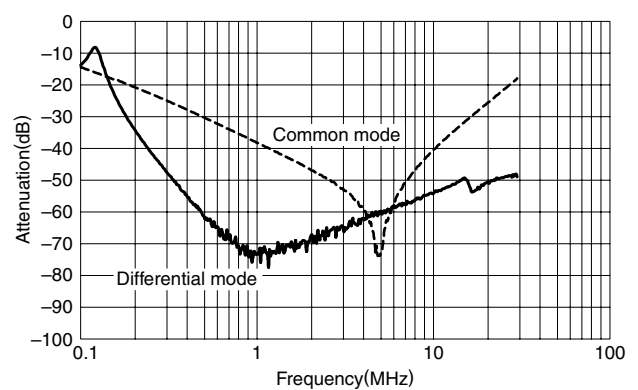

RSAN-2020

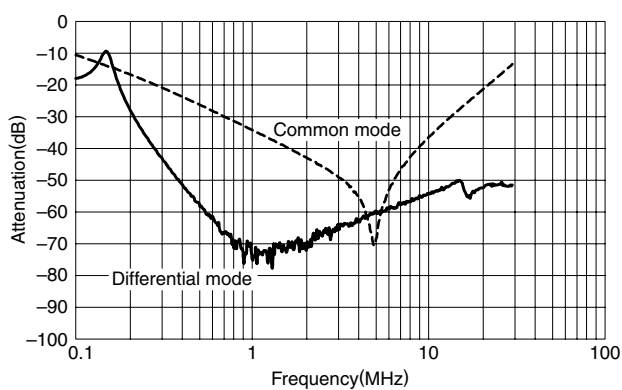

RSAN-2030

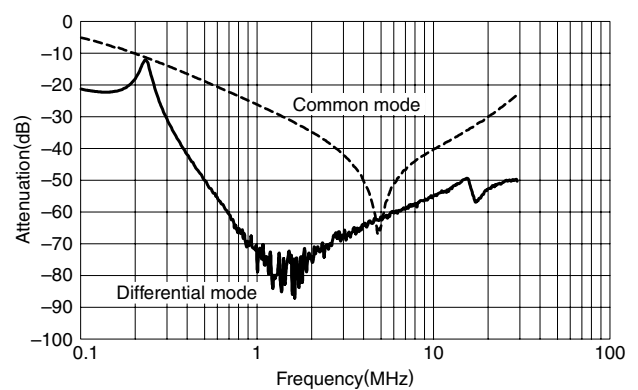

RSAN-2040

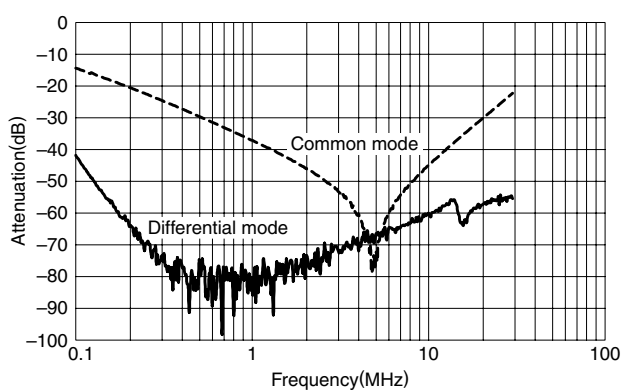

RSAN-2050

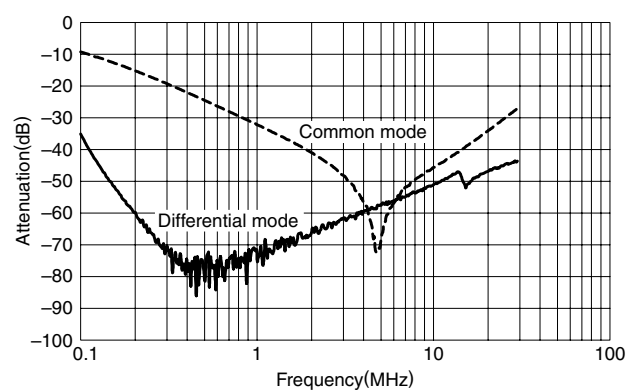

RSAN-2060



RSAN-2003L

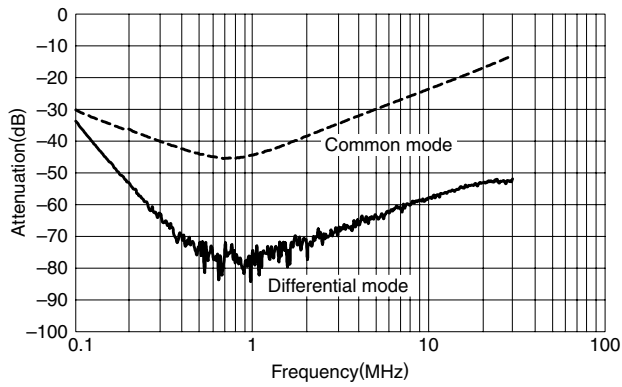

RSAN-2006L



RSAN-2010L

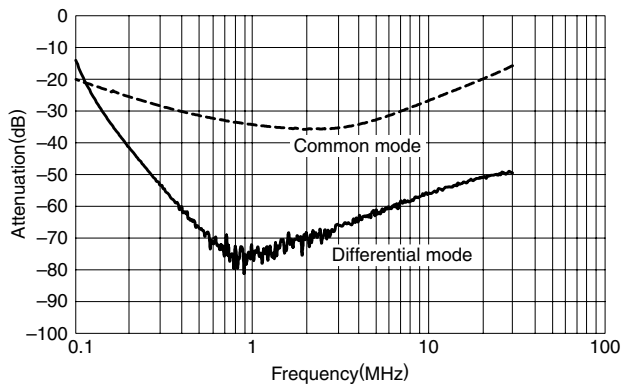

RSAN-2016L



RSAN-2020L

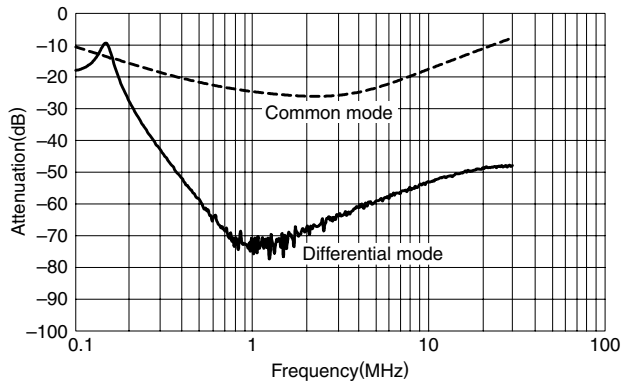

RSAN-2030L



Компания «Life Electronics» занимается поставками электронных компонентов импортного и отечественного производства от производителей и со складов крупных дистрибьюторов Европы, Америки и Азии.

С конца 2013 года компания активно расширяет линейку поставок компонентов по направлению коаксиальный кабель, кварцевые генераторы и конденсаторы (керамические, пленочные, электролитические), за счёт заключения дистрибьюторских договоров

Мы предлагаем:

- Конкурентоспособные цены и скидки постоянным клиентам.
- Специальные условия для постоянных клиентов.
- Подбор аналогов.
- Поставку компонентов в любых объемах, удовлетворяющих вашим потребностям.
- Приемлемые сроки поставки, возможна ускоренная поставка.
- Доставку товара в любую точку России и стран СНГ.
- Комплексную поставку.
- Работу по проектам и поставку образцов.
- Формирование склада под заказчика.
- Сертификаты соответствия на поставляемую продукцию (по желанию клиента).
- Тестирование поставляемой продукции.
- Поставку компонентов, требующих военную и космическую приемку.
- Входной контроль качества.
- Наличие сертификата ISO.

В составе нашей компании организован Конструкторский отдел, призванный помогать разработчикам, и инженерам.

Конструкторский отдел помогает осуществить:

- Регистрацию проекта у производителя компонентов.
- Техническую поддержку проекта.
- Защиту от снятия компонента с производства.
- Оценку стоимости проекта по компонентам.
- Изготовление тестовой платы монтаж и пусконаладочные работы.



Тел: +7 (812) 336 43 04 (многоканальный)

Email: [org@lifeelectronics.ru](mailto:org@lifeelectronics.ru)