

# RSAN SERIES

## Multipurpose Single-Phase Filter Compatible with High-Voltage Pulse



### FEATURES

- Amorphous core is used as the common mode coil core for the RSEN series, which helps prevent device error.
- Self-tightening screws and an open/close type cover make wiring work easier.
- Optional low-leakage current characteristic type and DIN rail installation compatible type are also available.
- Compliant with RoHS directives.

### SAFETY STANDARDS

UL1283	File No. E62388
CSA C22.2 No.8	File No. 208777
EN60939	Licence Ref. No. SE/07115-2

### PRODUCT IDENTIFICATION



### CIRCUIT DIAGRAMS

RSAN-2 \*\*\*  
RSAN-2 \*\*\* D



RSAN-2 \*\*\* L

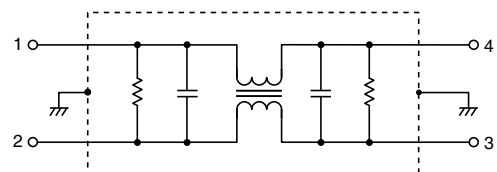

• Conformity to RoHS Directive: This means that, in conformity with EU Directive 2002/95/EC, lead, cadmium, mercury, hexavalent chromium, and specific bromine-based flame retardants, PBB and PBDE, have not been used, except for exempted applications.

• All specifications are subject to change without notice.

## ELECTRICAL CHARACTERISTICS

Part No.	Rated voltage (AC/DC)	Rated current (AC/DC)	Withstand voltage	Insulation resistance	Leakage current	Operating temperature range	With derating over	DC resistance (mΩ)	Attenuation frequency range (MHz)		
									Common mode		Differential mode
									at 25dB		at 25dB
RSAN-2003	250V	3A	AC.2500V 60s [Between line to ground]	100MΩ min. [DC.500V/ 1min.]	1.0mA max. [250V/60Hz]	-25 to +85°C	55°C	250 max.	0.1 to 10	0.1 to 30	
RSAN-2006		6A						110 max.	0.1 to 10	0.1 to 30	
RSAN-2010		10A						40 max.	0.3 to 10	0.2 to 30	
RSAN-2016		16A						20 max.	0.8 to 10	0.3 to 30	
RSAN-2020		20A						10 max.	1 to 10	0.3 to 30	
RSAN-2030		30A						6 max.	2 to 10	0.4 to 30	
RSAN-2040		40A						6 max.	0.8 to 10	0.1 to 30	
RSAN-2050		50A						4 max.	1 to 10	0.1 to 30	
RSAN-2060		60A						3 max.	2 to 10	0.2 to 30	

Part No.	Rated voltage (AC/DC)	Rated current (AC/DC)	Withstand voltage	Insulation resistance	Leakage current	Operating temperature range	With derating over	DC resistance (mΩ)	Attenuation frequency range (MHz)		
									Common mode		Differential mode
									at 20dB	at 10dB	at 25dB
RSAN-2003L	250V	3A	AC.2500V 60s [Between line to ground]	100MΩ min. [DC.500V/ 1min.]	10 μ A max. [250V/60Hz]	-25 to +85°C	55°C	250 max.	0.1 to 3	-	0.1 to 30
RSAN-2006L		6A						110 max.	0.1 to 3	-	0.1 to 30
RSAN-2010L		10A						40 max.	0.5 to 6	-	0.2 to 30
RSAN-2016L		16A						20 max.	-	0.3 to 10	0.3 to 30
RSAN-2020L		20A						10 max.	-	0.5 to 8	0.3 to 30
RSAN-2030L		30A						6 max.	-	3 to 20	0.4 to 30

## DERATINGS



■ SHAPES AND DIMENSIONS

RSAN-2003/2006/2010/2016/2020/2030

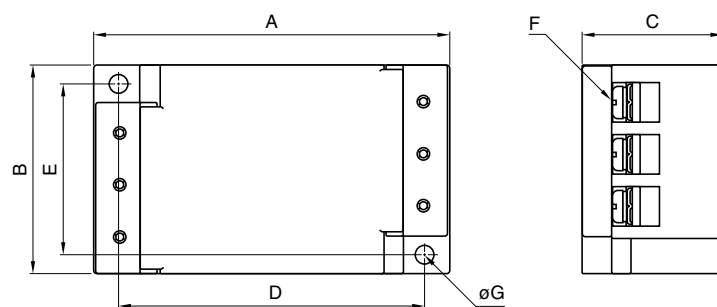

RSAN-2040/2050/2060

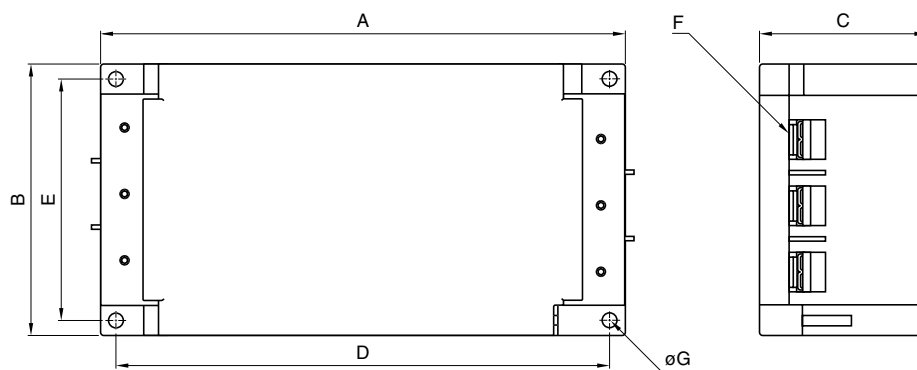

Dimensions in mm

Part No.	A	B	C	D	E	F	$\phi G$	Recommended clamping torque
RSAN-2003	87	52	35	75	43	M4	4.5	1.27N · m
RSAN-2006								
RSAN-2010								
RSAN-2016								
RSAN-2020								
RSAN-2030	170	90	54	160	80	M5	4.5	2.5N · m
RSAN-2040								
RSAN-2050								
RSAN-2060								

RSAN-2003D/2006D/2010D/2016D/2020D/2030D



Dimensions in mm

Part No.	A	B	C	D	E	F	G	H	I	J	K
RSAN-2003D	87	52	35	75	43	M4	M4	98	8.4	8.5	3.5
RSAN-2006D											
RSAN-2010D											
RSAN-2016D											
RSAN-2020D											
RSAN-2030D											

**ATTENUATION vs. FREQUENCY CHARACTERISTICS**

RSAN-2003

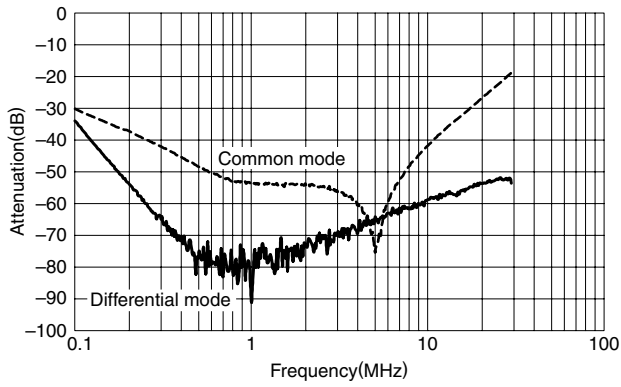

RSAN-2006

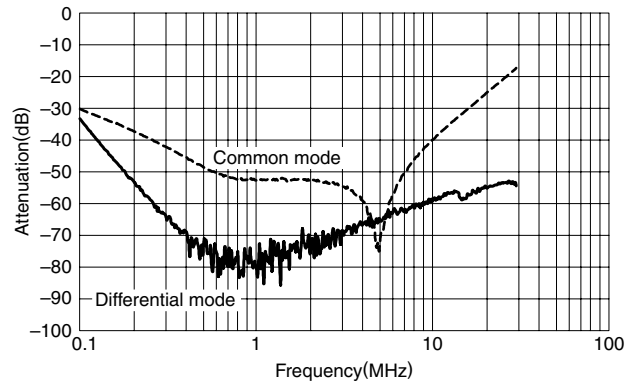

RSAN-2010



RSAN-2016

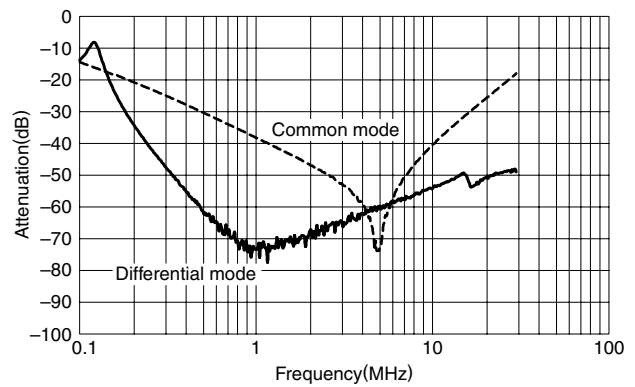

RSAN-2020



RSAN-2030

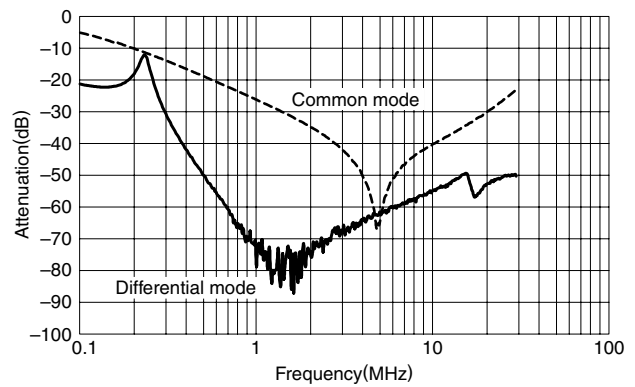

RSAN-2040



RSAN-2050

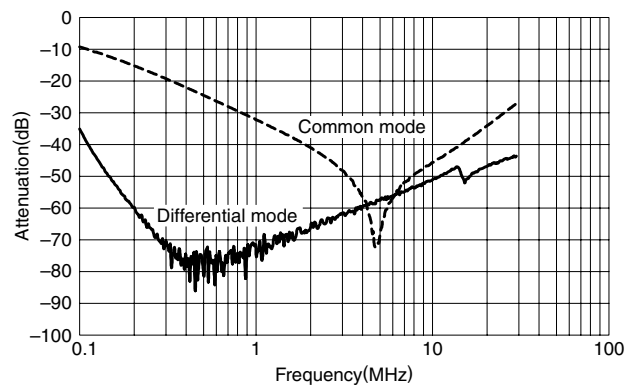

RSAN-2060



RSAN-2003L



RSAN-2006L



RSAN-2010L



RSAN-2016L



RSAN-2020L



RSAN-2030L



Компания «Life Electronics» занимается поставками электронных компонентов импортного и отечественного производства от производителей и со складов крупных дистрибьюторов Европы, Америки и Азии.

С конца 2013 года компания активно расширяет линейку поставок компонентов по направлению коаксиальный кабель, кварцевые генераторы и конденсаторы (керамические, пленочные, электролитические), за счёт заключения дистрибьюторских договоров

Мы предлагаем:

- Конкуренспособные цены и скидки постоянным клиентам.
- Специальные условия для постоянных клиентов.
- Подбор аналогов.
- Поставку компонентов в любых объемах, удовлетворяющих вашим потребностям.
- Приемлемые сроки поставки, возможна ускоренная поставка.
- Доставку товара в любую точку России и стран СНГ.
- Комплексную поставку.
- Работу по проектам и поставку образцов.
- Формирование склада под заказчика.
- Сертификаты соответствия на поставляемую продукцию (по желанию клиента).
- Тестирование поставляемой продукции.
- Поставку компонентов, требующих военную и космическую приемку.
- Входной контроль качества.
- Наличие сертификата ISO.

В составе нашей компании организован Конструкторский отдел, призванный помогать разработчикам, и инженерам.

Конструкторский отдел помогает осуществить:

- Регистрацию проекта у производителя компонентов.
- Техническую поддержку проекта.
- Защиту от снятия компонента с производства.
- Оценку стоимости проекта по компонентам.
- Изготовление тестовой платы монтаж и пусконаладочные работы.



Тел: +7 (812) 336 43 04 (многоканальный)

Email: [org@lifeelectronics.ru](mailto:org@lifeelectronics.ru)