

# Amphenol®

Industrial Solar Technologies



# Solar Line

PHOTOVOLTAIC INTERCONNECTION SYSTEM

## ASIA

**Amphenol Technology (Shenzhen) Co., Ltd**  
Building C, 2nd Industrial Zone of Xia Shi Jia  
Gongming sub-district, Guangming New district  
Shenzhen, China 518106  
Telephone : +86 -755 -29918389

## NORTH AMERICA

**Amphenol Industrial Operations**  
191 Delaware Avenue  
Sidney, New York 13838-1395 USA  
Ph: +1-888-364-9011 Fax: +1-520-397-7169

**Amphenol Industrial Solar Technologies**  
180 N Freeport DR. W-10, Nogales AZ 85621-2423  
Telephone: +1-520-397-7047

## EUROPE & THE MIDDLE EAST & AFRICA

**Amphenol Industrial Operations Europe**  
Via Barbaiana n. 5-20020 Lainate-milano-Italy  
Telephone: +39-348-3145390 Fax: 39-02-9325-4444

**Amphenol Industrial Operations Middle East**  
Office No C-37, Ajman Free Zone-UAE  
Telephone: +39-348-3145390 Fax: -9716-7422941

**Amphenol®**  
Industrial Solar Technologies

# E xpanding Global Presence

Founded in 1932, Amphenol is a global leader in interconnect technology, and is one of the world's largest connector manufacturers. Amphenol designs, manufactures, and markets solar products, electronic, and fiber optic connectors, interconnect systems, and coaxial and specialty cables.

Amphenol products are engineered and manufactured in the Americas, Europe, Asia, and Africa and sold by a worldwide sales and marketing organization. Amphenol has a diversified presence as a leader in high growth areas of the interconnect industry and provides solutions for customers in the automotive, broadband, industrial, information technology and data communications, military and aerospace, mobile devices, and mobile networks markets.

please click the hyperlink [www.amphenol.com/about](http://www.amphenol.com/about) get more information.

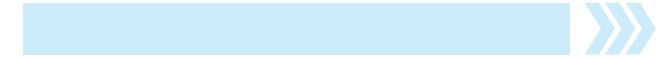

## Table of Contents

Connectors	Page1-18
Cable and Cable assemblies	Page19-22
Junction boxes	Page23-28
Tools and Accessories	Page29-33

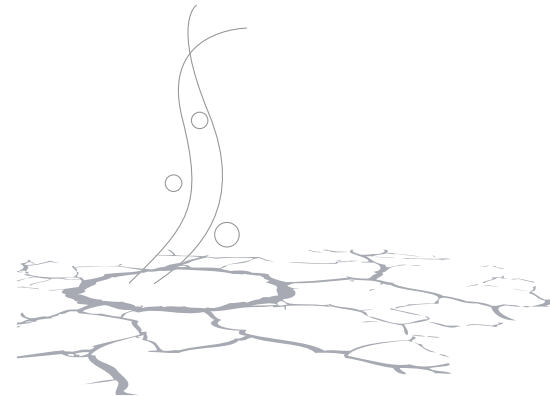

## H4 PV Cable Connector

H4 Female PV Cable Connector

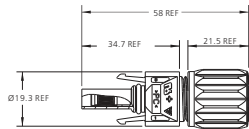

H4 Female socket contact

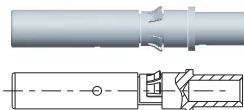

H4 Male PV Cable Connector

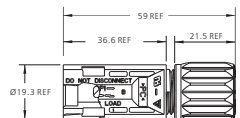

H4 Male pin contact



### How to order

Product family	Product	Gender	Connector type	Cable size	Approvals	Connector packaging	Contact*
H4 Helios H4	C Connector	F Female M Male	C Cable gland	2 2.5mm <sup>2</sup> /14 AWG 4 4.0mm <sup>2</sup> /12 AWG&6.0mm <sup>2</sup> /10 AWG (S&F) 4.0mm <sup>2</sup> /12 AWG (C&F) 6.0mm <sup>2</sup> /10 AWG (C&F) 8 10.0mm <sup>2</sup> /8 AWG (C&F) 0 Less contacts	D Dual (TUV/UL)	I 1pcs/bag, 800pcs/box C 100pcs/bag, 10bags/box M 500 pcs/ bag, 2bags/box	S S&F Blank C&F

### Technical Data

Rated current (IEC 85°C)	25A(2.5mm <sup>2</sup> /14AWG), 35A(4.0mm <sup>2</sup> /12AWG) 45A(6.0mm <sup>2</sup> /10AWG)
Rated voltage	1000V DC (TUV) 1500V DC (UL)
Rated impulse voltage	12KV(IEC)
Contact resistance	≤0.30mΩ for S&F contact, ≤0.25mΩ for C&F contact, TYP
Contact material	Copper, tin plated
Contact system	Stamped and Formed / Cold Formed contact with RADSOX® insert
Insulation material	PC/PA
Locking mechanism	Snap-lock, special unlocking tool required to un-mate as required by NEC2011
Cable strain relief	Compression gland with ratcheting gland nut
Degree of protection	IP68 (1m, 1h) mated
Safety class	II
Pollution degree	2
Flame class	UL94 V-0
Jacket of cable range	Ø4.5mm~Ø7.8mm
Ambient temperature range	-40°C~+85°C

### Ordering example:

- H4CFC4DMS H4 cable connector, female, 4.0mm<sup>2</sup>/12AWG & 6.0 mm<sup>2</sup>/10AWG S&F contact, 1000pcs per box
- H4CFC4DM H4 cable connector, female, 4.0mm<sup>2</sup>/12AWG C&F contact, 1000pcs per box

\* Stamped and Formed (S&F) and Cold Formed (C&F) contact options

## H4 Stamped and Formed Contact

Packaged on a reel for automatic assembly

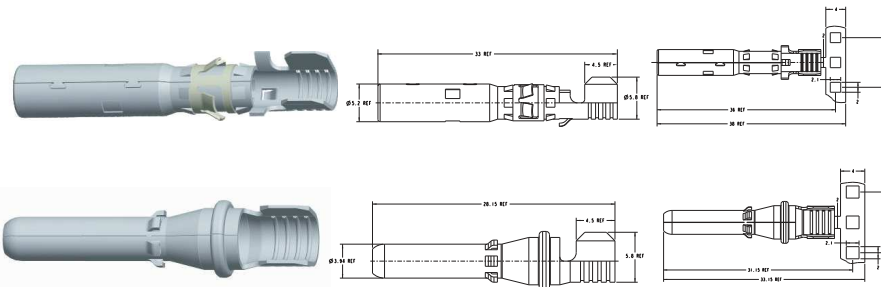
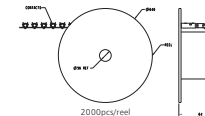

### H4 S&F Contact Ordering Code (For Ordering Contacts on Reels)

Product family	Contact type	Gender	Cable size	Packing
H4 Helios H4	F S&F contact	F Female M Male	2 1.5mm <sup>2</sup> /16AWG & 2.5mm <sup>2</sup> /14AWG 4 4.0mm <sup>2</sup> /12AWG & 6.0mm <sup>2</sup> /10AWG	R 2000/reel

Note: If ordering contacts in 2000pcs/reel version, need to order contact and plastic housing separately. Contact ordering code refers to this table, plastic housing should be chosen as H4CFC0DM for female housing and H4CMC0DM for male housing.

### Ordering Example:

- H4CFC0DM: H4 Female housing assembly (1pcs)
- H4CMC0DM: H4 Male housing assembly (1pcs)
- H4FF4R H4 female contact on reel, 4.0mm<sup>2</sup>/12 AWG & 6.0mm<sup>2</sup>/10 AWG (2000pcs)
- H4FM2R H4 male contact on reel, 2.5mm<sup>2</sup>/14 AWG (2000pcs)

### Assembly Tool



■ Tool-kit H4TK0000 ■ Unlock tool H4TU0000 ■ Wrench tool H4TW0001 ■ Strip tool H4TS0000 ■ Crimp tool for S&F contact H4TC0002 ■ Inspection tool H4TT0001  
Crimp tool for C&F contact H4TC0001

■ More tools refer to page 29-33.

## Enlarge H4 PV Cable Connector

Enlarge H4 Female Cable Connector

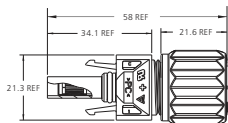

H4 Enlarge Female socket contact

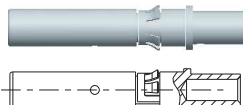

Enlarge H4 Male Cable Connector

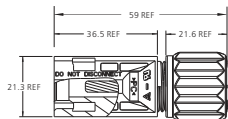

H4 Enlarge Male pin contact

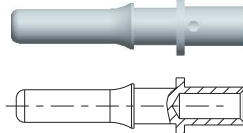

### How to order

Product family	Product	Gender	Connector type	Cable size	Approvals	Connector packaging
H4 Helios H4	C Connector	F Female M Male	E H4 Enlarge connector	8 10.0mm <sup>2</sup> /8AWG	D Dual (TUV/UL)	I 1pcs/bag, 800pcs/box C 100pcs/bag, 8bag/box M 400pcs/bag, 2bags/box

### Technical Data

Rated current	50A(UL) 65A (TUV)
Rated voltage	1000V DC (TUV/UL)
Rated impulse voltage	12KV(IEC)
Contact resistance	≤0.25mΩ,TYP
Contact material	Copper, tin plated
Contact size and system	10.0mm <sup>2</sup> /8AWG , Cold formed
Insulation material	PC/PA
Degree of protection	Ip68 (1m, 1h) mated
Safety class	II
Pollution degree	2
Flame class	UL94, V-0
Jacket of cable range	Ø7.6mm~Ø9.3mm
Ambient temperature range	-40°C~+85°C

### Ordering example:

- H4CFE8DM Enlarge H4 cable connector, female , 10.0mm<sup>2</sup>/8AWG C&F contact, 800pcs per box
- H4CME8DM Enlarge H4 cable connector, male , 10.0mm<sup>2</sup>/8AWG C&F contact, 800pcs per box



H4TW0004  
Wrench tool for Enlarge H4

## H4 PV Panel Connector

H4 Female PV Panel Connector

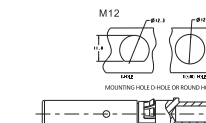
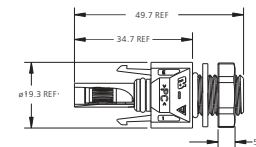

H4 Male PV Panel Connector

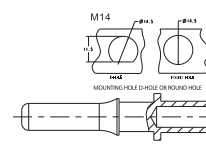
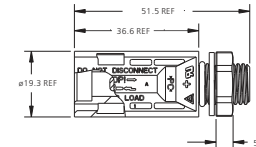

### How to order

Product family	Product	Gender	Connector type	Cable size	Approvals	Connector packaging	Contact *
H4 Helios H4	C Connector	F Female M Male	M bulkhead M12 N bulkhead M14	2 2.5mm <sup>2</sup> /14 AWG 4 4.0mm <sup>2</sup> /12 AWG&6.0mm <sup>2</sup> /10 AWG (S&F) 4 4.0mm <sup>2</sup> /12 AWG (C&F) 6 6.0mm <sup>2</sup> /10 AWG (C&F) 8 10.0mm <sup>2</sup> /8 AWG (C&F) 0 Less contacts	D Dual (TUV/UL)	I 1pcs/bag, 800pcs/box C 100pcs/bag, 10bags/box M 500 pcs/ bag, 2bags/box	S S&F Blank C&F

### Technical Data

Rated current (IEC 85°C)	25A(2.5mm <sup>2</sup> /14AWG), 35A(4.0mm <sup>2</sup> /12AWG) 45A(6.0mm <sup>2</sup> /10AWG)
Rated voltage	1500V DC (TUV) 1500V DC (UL)
Rated impulse voltage	16KV(IEC)
Contact resistance	≤0.30mΩ for S&F contact, ≤0.25mΩ for C&F contact,TYP
Contact material	Copper, tin plated
Contact system	Stamped and Formed / Cold Formed contact with RADSOK® insert
Insulation material	PC/PA
Degree of protection	IP68 (1 meter, 1 hour) mated
Safety class	II
Pollution degree	2
Flame class	UL94 V-0
Jacket of cable range	Ø4.5mm~Ø7.8mm
Ambient temperature range	-40°C~+85°C

### Ordering example:

- H4CFM4DMS H4 bulkhead M12 connector, female , 4.0mm<sup>2</sup>/12AWG & 6.0 mm<sup>2</sup>/10AWG S&F contact, 1000pcs per box
- H4CFM4DM H4 bulkhead M12 connector, female , 4.0mm<sup>2</sup>/12AWG C&F contact, 1000pcs per box

\* Stamped and Formed (S&F) and Cold Formed (C&F) contact options

\* If ordering contacts in 2000pcs/reel version, please refer to page 02.

## H4-H PV Cable Connector

### H4-H Female PV Cable Connector

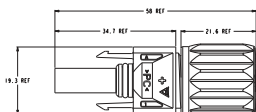

H4 Female socket contact

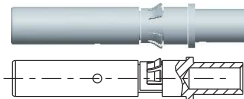

### H4-H Male PV Cable Connector

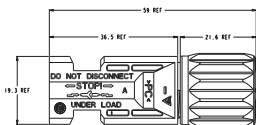

H4 Male pin contact

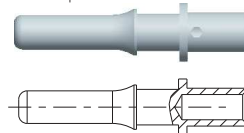

R 50157783

#### How to order

Product family	Product	Gender	Connector type	Cable size	Approvals	Connector packaging	Contact*	
H4	Helios H4	C Connector	F Female M Male	D Manually cable connector	2 2.5mm <sup>2</sup> 4 4.0mm <sup>2</sup> /6.0mm <sup>2</sup> (S&F) 4.0mm <sup>2</sup> (C&F) 6 6.0mm <sup>2</sup> (C&F) 8 10.0mm <sup>2</sup> (C&F) 0 Less contacts	T TUV	I 1pcs/bag, 800pcs/box C 100pcs/bag, 10bags/box M 500 pcs/ bag, 2bags/box	S S&F Blank C&F

#### Technical Data

Rated current (IEC)	25A(2.5mm <sup>2</sup> /14AWG), 35A(4.0mm <sup>2</sup> /12AWG), 45A(6.0mm <sup>2</sup> /10AWG)
Rated voltage	1000V DC
Contact resistance	≤0.30mΩ for S&F contact, ≤0.25mΩ for C&F contact, TYP
Contact material	Copper, tin plated
Contact system	Stamped and Formed / Cold Formed contact
Insulation material	Thermoplastic
Degree of protection	IP68 (1 meter, 1 hour) mated
Flame class	UL94 V-0
Jacket of cable range	Ø4.5mm~Ø7.8mm
Ambient temperature range	-40°C~+85°C

#### Ordering example:

- H4CFD4TMS H4-H manually cable connector, female, 4.0mm<sup>2</sup>/12AWG & 6.0mm<sup>2</sup>/10AWG S&F contact, 1000pcs per box
- H4CFD4TM H4-H manually cable connector, female, 4.0mm<sup>2</sup>/12AWG C&F contact, 1000pcs per box

\* Stamped and Formed (S&F) and Cold Formed (C&F) contact options  
\* If ordering contacts in 2000pcs/reel version, please refer to page 02.

## H4-H PV Panel Connector

### H4-H Female PV Panel Connector

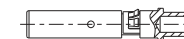
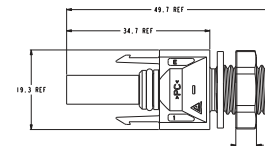

### H4-H Male PV Panel Connector

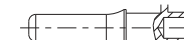
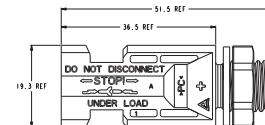

R 50157783

#### How to order

Product family	Product	Gender	Connector type	Cable size	Approvals	Connector packaging	Contact*	
H4	Helios H4	C Connector	F Female M Male	B Manually bulkhead connector	2 2.5mm <sup>2</sup> 4 4.0mm <sup>2</sup> /6.0mm <sup>2</sup> (S&F) 4.0mm <sup>2</sup> (C&F) 6 6.0mm <sup>2</sup> (C&F) 8 10.0mm <sup>2</sup> (C&F) 0 Less contacts	T TUV	I 1pcs/bag, 800pcs/box C 100pcs/bag, 10bags/box M 500 pcs/ bag, 2bags/box	S S&F Blank C&F

#### Technical Data

Rated current (IEC)	25A(2.5mm <sup>2</sup> /14AWG), 35A(4.0mm <sup>2</sup> /12AWG), 45A(6.0mm <sup>2</sup> /10AWG)
Rated voltage	1500V DC
Contact resistance	≤0.30mΩ for S&F contact, ≤0.25mΩ for C&F contact, TYP
Contact material	Copper, tin plated
Contact system	Stamped and Formed / Cold Formed contact
Insulation material	Thermoplastic
Degree of protection	IP68 (1 meter, 1 hour) mated
Flame class	UL94 V-0
Jacket of cable range	Ø4.5mm~Ø7.8mm
Ambient temperature range	-40°C~+85°C

#### Ordering example:

- H4CFB4TMS H4-H manually bulkhead connector, female, 4.0mm<sup>2</sup>/12AWG & 6.0mm<sup>2</sup>/10AWG S&F contact, 1000pcs per box
- H4CFB4TM H4-H manually bulkhead connector, female, 4.0mm<sup>2</sup>/12AWG C&F contact, 1000pcs per box

\* Stamped and Formed (S&F) and Cold Formed (C&F) contact options  
\* If ordering contacts in 2000pcs/reel version, please refer to page 02.

## UTX™ PV Cable Connector

UTX™ Female Cable Connector



UTX™ Female socket contact



UTX™ Male Cable Connector



UTX™ Male pin contact



## UTX Stamped and Formed Contact

Packaged on a reel for automatic assembly

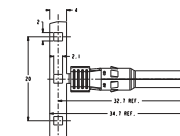
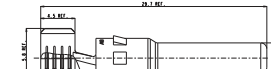
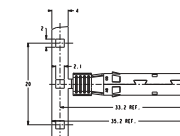
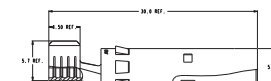
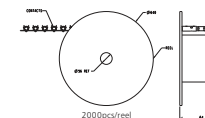

### How to order

Product family	Product Type	Gender	Contact type*
UTX UTX	C Connector	F Female M Male	A Stamped and Formed Contact (S&F) B Cold Formed Contact (C&F)
Cable Size	Approvals	Packaging	
2 2.5mm <sup>2</sup> /14 AWG 4 4.0mm <sup>2</sup> /12 AWG&6.0mm <sup>2</sup> /10 AWG (S&F) 4 4.0mm <sup>2</sup> /12 AWG (C&F) 6 6.0mm <sup>2</sup> /10 AWG (C&F) 0 Less contacts	A TÜV/UL/JET Certified	C 100 pcs/bag ,8 bags/box M 400 pcs/bag ,2 bags/box	

### Technical Data

Rated current (IEC85°C)	25A(2.5mm <sup>2</sup> /14AWG), 35A(4.0mm <sup>2</sup> /12AWG) 45A(6.0mm <sup>2</sup> /10AWG)
Rated voltage	1500V DC(TUV/UL/JET)
Contact resistance	≤0.30mΩ for S&F contact, ≤0.25mΩ for C&F contact, TYP
Contact material	Copper ,tin plated
Contact system	Stamped and Formed / Cold Formed contact
Insulation material	Thermoplastic
Degree of protection	Ip68 (1 m, 1h) mated
Flame class	UL94, V-0
Jacket of cable range	Ø5.3mm—Ø7.65mm
Ambient temperature range	-40°C~+85°C

### Ordering example:

- UTXCFA4AM UTX cable connector, female, 4.0mm<sup>2</sup>/12AWG & 6.0 mm<sup>2</sup>/10AWG S&F contact, 800pcs per box
- UTXCFB4AM UTX cable connector, female, 4.0mm<sup>2</sup>/12AWG C&F contact, 800pcs per box

\* Stamped and Formed (S&F) and Cold Formed (C&F) contact options

### UTX S&F Contact Ordering Code (For Ordering Contacts on Reels)

Product family	Product type	Gender	Contact size*	Packaging
UTX UTX	F S&F Contact	F Female M Male	2 2.5mm <sup>2</sup> /14AWG 4 4.0mm <sup>2</sup> /12AWG&6.0mm <sup>2</sup> /10AWG	R 2000 pcs/reel

Note: If ordering contacts in 2000pcs/reel version, need to order contact and plastic housing separately. Contact ordering code refers to this table, plastic housing should be chosen as UTXCFA0AM for female housing and UTXCMA0AM for male housing.

### Ordering Example:

- UTXCFA0AM: UTX Female housing assembly (1pcs)
- UTXCMA0AM: UTX Male housing assembly (1pcs)
- UTXFF4R UTX female contact on reel, 4.0mm<sup>2</sup>/12 AWG & 6.0mm<sup>2</sup>/10 AWG (2000pcs)
- UTXFM2R UTX male contact on reel, 2.5mm<sup>2</sup>/14 AWG (2000pcs)

### Assembly Tool



■ Tool-kit H4TK0000 ■ Unlock tool H4TU0000 ■ Wrench tool UTXTWA001 ■ Strip tool H4TS0000 ■ Crimp tool for S&F contact UTXTC0002 ■ Inspection tool UTXTTO001  
Crimp tool for C&F contact UTXTC0001

■ More tools refer to page 29-33.

## UTX™-XL PV Cable Connector

UTX™-XL Female Cable Connector



UTX™-XL Female socket contact



UTX™-XL Male Cable Connector



UTX™-XL Male pin contact

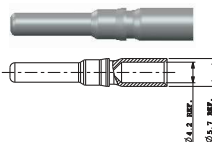

R 50283691



E 469330

### How to order

Product family	Product Type	Gender	Contact type	Cable size	Approvals	Packaging
UTX UTX	C Connector	F Female M Male	L UTX-XL	8 10.0mm <sup>2</sup> /8AWG	A DUAL(TUV/UL)	M 250 pcs/bag ,2 bags/box

### Technical Data

Rated current	75A (EN85°C) , 50A (UL)
Rated voltage	1500V DC
Contact resistance	≤0.25mΩ,TYP
Degree of protection	Ip68 (1m, 1h) mated
Contact material	Copper,tin plated
Contact size and Type	10mm <sup>2</sup> /8AWG,Cold formed contact
Insulation material	Thermoplastic
Flame class	UL94 , V-0
Jacket of cable range	Ø7.6mm-Ø9.3mm
Ambient temperature range	-40°C~+85°C

### Ordering example:

UTXCFL8AM:UTX-XL cable connector, Female end ,10.0mm<sup>2</sup>/8AWG C&F contact, 500pcs per box  
UTXCML8AM:UTX-XL cable connector, Male end ,10.0mm<sup>2</sup>/8AWG C&F contact, 500pcs per box



UTX™-XL Connector Wrench Tool  
P/N: UTXW001

## UTX™ PV Panel Connector

UTX Female Panel Connector

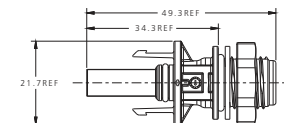

UTX Male Panel Connector

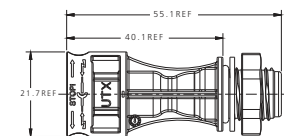

R 50340393



E 469330

### How to order

Product family	Product	Gender	Contact type*
UTX UTX	M Bulkhead M12 N Bulkhead M14	F Female M Male	A Stamped and Formed Contact (S&F) B Cold Formed Contact(C&F)
Cable Size*		Approvals	Packaging
2 2.5mm <sup>2</sup> /14 AWG 4 4.0mm <sup>2</sup> /12 AWG & 6.0mm <sup>2</sup> /10 AWG (S&F) 4.0mm <sup>2</sup> /12 AWG (C&F) 6 6.0mm <sup>2</sup> /12 AWG (C&F) 0 Less contacts		A TÜV/UL Certified	I 1pcs/bag, 800pcs/box C 100 pcs/bag ,8 bags/box M 400 pcs/bag ,2 bags/box

### Technical Data

Rated current (IEC)	25A ( 2.5mm <sup>2</sup> /14AWG) , 35A ( 4.0mm <sup>2</sup> /12AWG) 45A (6.0mm <sup>2</sup> /10AWG)
Rated voltage	1500V DC (TUV/UL)
Contact resistance	≤0.30mΩ for S&F contact, ≤0.25mΩ for C&F contact,TYP
Contact material	Copper, tin plated
Contact system	Stamped and Formed / Cold Formed contact
Insulation material	Thermoplastic
Degree of protection	IP68
Cable applicability	2.5mm <sup>2</sup> ~6.0mm <sup>2</sup>
Flame class	UL94, V-0
Ambient temperature range	-40°C~+85°C

### Ordering example:

- UTXMFA4AM UTX M12 bulkhead, female , 4.0mm<sup>2</sup>/12AWG & 6.0 mm<sup>2</sup>/10AWG S&F contact, 800pcs per box
- UTXMFB4AM UTX M12 bulkhead, female , 4.0mm<sup>2</sup>/12AWG C&F contact, 800pcs per box

\* Stamped and Formed (S&F) and Cold Formed (C&F) contact options

\* If ordering contacts in 2000pcs/reel version, please refer to page 08.



## H4-R PV Connector

H4-R Female Cable Connector

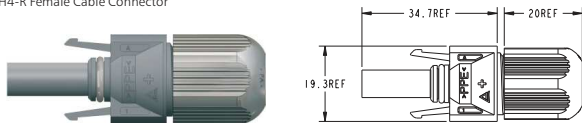

H4-R Male Cable Connector

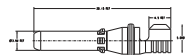

H4-R Female Panel Connector

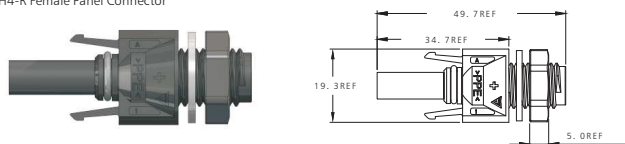

H4-R Male Panel Connector

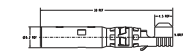
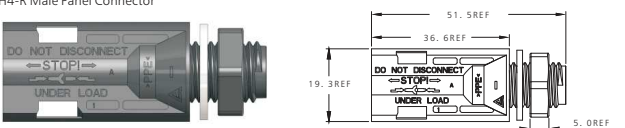

## H4-RH PV Connector

H4-RH Female Cable Connector

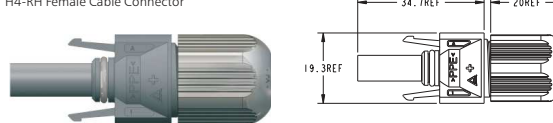

H4-RH Male Cable Connector

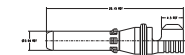
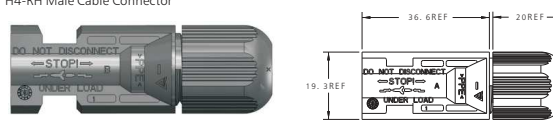

H4-RH Female Panel Connector

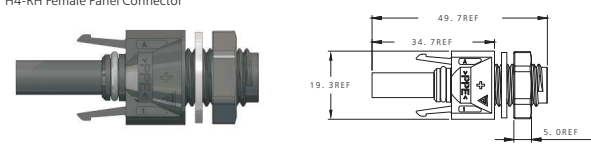

H4-RH Male Panel Connector

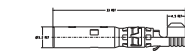
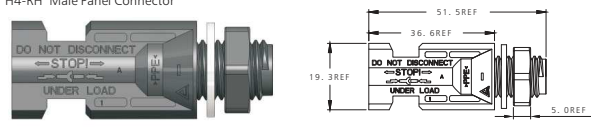

R 50157783

### How to order

Product family	Product type	Gender	Connector type
H4 H4	L H4-R connector	F Female M Male	C Cable connector_H4-R M Bulkhead M12_H4-R B Bulkhead M12_H4-RH D Cable connector_H4-RH
Cable size	Approvals	Packaging	Contact*
2 2.5 mm <sup>2</sup> 4 4.0 mm <sup>2</sup> & 6.0 mm <sup>2</sup>	T TUV	C 100pcs/bag, 10bags/box M 500pcs/bag, 2bags/box	S S&F contact

### Ordering example:

- H4LFC4TMS H4-R type, female cable connector, 4mm<sup>2</sup> & 6mm<sup>2</sup> S&F contact, 1000pcs per box
- H4LFM4TMS H4-R type, female panel connector, 4mm<sup>2</sup> & 6mm<sup>2</sup> S&F contact, 1000pcs per box
- H4LFD4TMS H4-RH type, female cable connector, 4mm<sup>2</sup> & 6mm<sup>2</sup> S&F contact, 1000pcs per box
- H4LFB4TMS H4-RH type, female panel connector, 4mm<sup>2</sup> & 6mm<sup>2</sup> S&F contact, 1000pcs per box

\* If ordering contacts in 2000pcs/reel version, please refer to page 02.

### Technical Data

Rated current (IEC85°C)	25A for 2.5mm <sup>2</sup> , 35A for 4.0mm <sup>2</sup> , 45A for 6.0mm <sup>2</sup>
Rated voltage	1100V DC (TUV)
Contact resistance	≤0.3mΩ, TYP
Contact material	Copper, tin plated
Contact system	Stamped formed contact
Insulation material	Thermoplastic
Degree of protection	IP68 (1m, 1h) mated
Cable applicability	2.5mm <sup>2</sup> ~6.0mm <sup>2</sup>
Flame class	UL94, V-0
Jacket of cable range	Ø5.94mm~Ø6.97mm
Ambient temperature range	-40°C~+85°C

### Assembly Tool



■ Tool-kit H4TK0000 ■ Unlock tool H4TU0000 ■ Wrench tool H4TW0001 ■ Strip tool H4TS0000 ■ Crimp tool H4TC0002 ■ Inspection tool H4TT0001

■ More tools refer to page 29-33.



### H4 Branch Connector

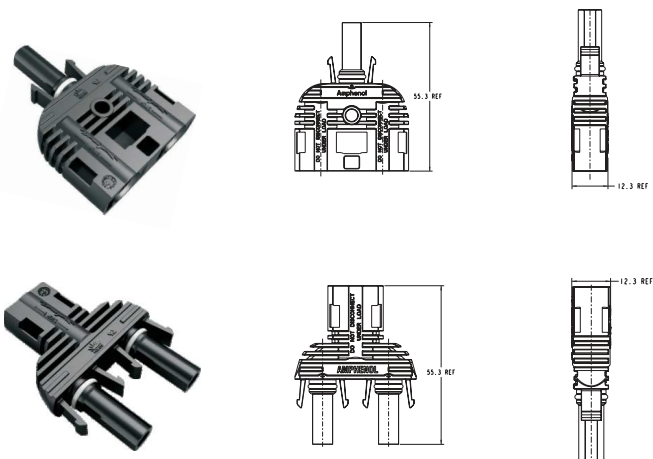

#### How to order

Product family	Product type	Gender
H4 Helios H4	Y Branch connector	X FFM (branch 2 female/1 male) Y MMF (branch 2 male/1 female)

#### Technical Data

Rated current	30A max.
Rated voltage	1000V DC(UL) 1500V DC(ETL)
Contact resistance	0.50mΩ TYP
Contact material	Copper, tin plated
Insulation material	Thermoplastic, UL94 V-0
Degree of protection(mated)	IP68(1m, 1h)
Ambient temperature range	-40°C ~ +90°C

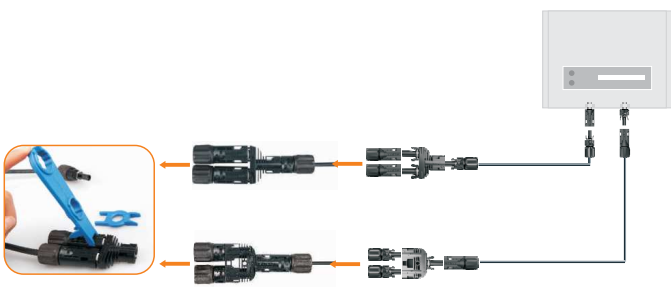

### Branch Fuse Connector

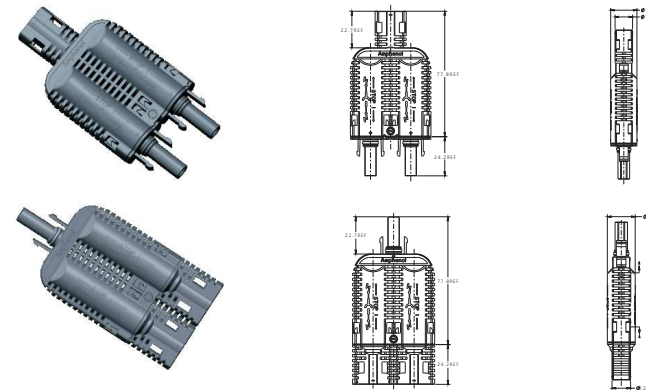

#### How to order

Product family	Product	Gender
H4 Helios H4	Y Branch connector	FFM Branch 2 female/1 male MMF Branch 2 male/1 female
Fuse range	Fuse current (1~30A)	Variations
A 16A~30A B 1~15A fuse	01 1A ..... 15 15A ..... 30 30A	A Unlock type

#### Technical Data

Rated current of fuse	1A~30A
Rated voltage	1000V
Contact resistance	12mΩ Typ
Degree of protection	IP68 (1m, 1h) mated
Number of fuse	2
Contact material	Copper, Tin plated
Insulation material	Thermoplastic
Ambient temperature range	-40°C~+85°C

#### Ordering example:

- H4YFFMB15A 1000V branch fuse connector, 2female/1male, 15A

### 1500V Inline Fuse Connector



How to order				
Product family	Product	Connector Type	Fuse Voltage	Fuse Current rating
UTX UTX	G Assembled fuse	FM Female to Male	3 1500V	01 1A ..... 15 15A

Technical Data	
Rated voltage	1500V DC
Rated current of fuse	1A to 15A
Protection degree(mated)	IP68
Number of fuse	1
Replaceable of use	No
Contact material	Copper, Tin plated
Insulation material	Thermoplastic, UL94 V-0
Ambient temperature range	-40°C~+85°C

#### Ordering example:

- UTXGM315 1500V UTX Inline fuse connector, 15A current

### 1000V Inline Fuse Connector



How to order				
Product family	Product	Connector Type	Fuse Voltage	Fuse Current rating
UTX UTX type	F Molded fuse	FM Female to Male	2 1000V	01 1A ..... 15 15A ..... 30 up to 30A

Technical Data	
Interrupting rating	10KA
Voltage rating	1000V max
Amperage rating	30A max
Connector options	M-F
Degree of protection(mated)	IP68
Cable range	2.5mm <sup>2</sup> /14AWG~10.0mm <sup>2</sup> /8AWG
Ambient temperature range	-40°C ~ +90°C

#### Ordering example:

- UTXFFM215 1000V UTX Inline fuse connector, 15A current

## HelioLug



### INSTALLATION INSTRUCTIONS:

- Place the lug to the designated module grounding hole with the star washer between the grounding lug and the module frame in order to break through the anodizing and establish electrical contact with the aluminum. Torque the bolt and nut to 30 in-lbs. NOTE: These instructions provide guidelines for general use. If available, the specific module manufacturer's instructions for the location of the star washer are to be followed.

- For the attachment to the racking, slide the bolt into the mounting channel of the extrusion or into a 1/8" Hole drilled through the extrusion. Place the star washer between the racking and lug and secure the nut and bolt to 30 in-lbs. NOTE:

- Insert a 4 to 12 AWG copper wire into the lug and tighten the lug set screw to the copper wire to the torque based on the wire size. (4-6 AWG at 35 in-lbs and 8-12 AWG at 30 in-lbs). Do not exceed the maximum rated overcurrent protection, 20 A (12 AWG), 40 A (10 AWG), 90 A (8 AWG), 150 A (6 AWG), and 200 A (4 AWG).

### Certified to UL2703 and cUL QIMS7 for Photovoltaic Bonding



How to order		
Product Family	Type	Approvals
HG Helios Grounding	L HelioLug (4~12AWG copper wire)	U UL 2703

## Helio Clip™



### Designed for UL2703 - PV Racking and Grounding

How to order		
Product family	Type	Approvals
HG Helios Grounding	C HelioClip Selftapping (10~12AWG copper wire) D HelioClip Mounting (10~12AWG copper wire)	U UL 2703 (Pending)

## Helio Bolt™



### Certified to UL2703 - PV Racking and Grounding



How to order		
Product family	Type	Approvals
HG Helios Grounding	M HelioBolt Mounting (6~12AWG copper wire)	U UL 2703

-100% Passivated Stainless Steel

## PowerLink solar cable

Halogen free photovoltaic cables are used as the interconnection wiring for photovoltaic power systems.

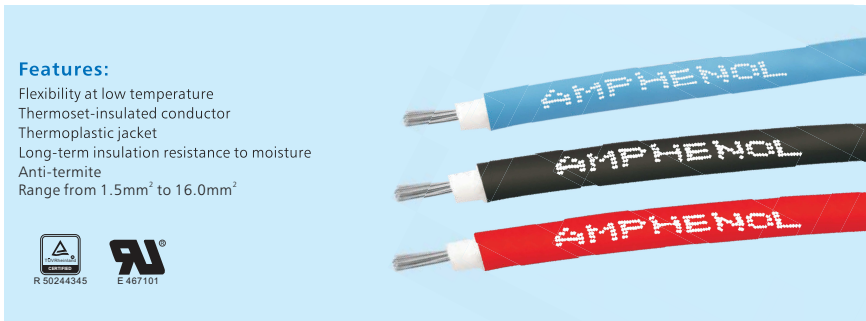

### Features:

- Flexibility at low temperature
- Thermoset-insulated conductor
- Thermoplastic jacket
- Long-term insulation resistance to moisture
- Anti-termite
- Range from 1.5mm<sup>2</sup> to 16.0mm<sup>2</sup>



### Certificate:

- EN50618, 1500V
- TÜV 2 PFG 1169/08.2007 PV1-F
- TÜV 2 PFG 1990/05.2012 PV 1500 DC-F
- UL 4703 PV wire, cTÜVus
- UL 4703 PV wire, 600V, 1000V, 2000V

### Structure:

- Conductor: Stranded bare or tinned copper
- Insulation: XLPE material (white and black)
- Jacket: XLPE material (Black, Red and Blue)

Temperature range:  
-40 °C to +90 °C

Environmental influence resistance:  
Acid, alkalinity, UV, ozone and hydrolysis-resistant.

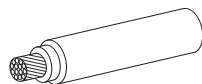
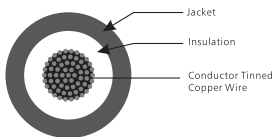

## PowerLink solar cable application:

Used in heavy-duty and harsh environment interconnection wiring, can be easily combined with our Helios H4 PV connector and junction box series for photovoltaic system applications.



Cold  
Snow  
Low temperature



Sun  
Drought  
High temperature



Rain  
Moisture

### How to order

Product family	Product	Cable color	Cable type
HC Helios cable	P Powerlink -standard A Armorlink-Rodent Proof U Powerlink- USE-2	B Black R Red L Blue G Grey O Brown	L VDE 0295-CLASS 2 7 Strands(USE-2) M Mult wire 19 strands (UL only) H VDE 0295-CLASS 5(UL,TUV and Dual)
Cable size	Approvals	Spec	Jacket type
1 1.5mm <sup>2</sup> /16AWG 2 2.5mm <sup>2</sup> /14AWG 4 4.0mm <sup>2</sup> /12AWG 5 25.0mm <sup>2</sup> /3AWG 6 6.0mm <sup>2</sup> /10AWG 8 10.0mm <sup>2</sup> /8AWG 9 16.0mm <sup>2</sup> /4AWG	T0 TUV 1000V D0 Dual UL600V TUV 1000V D1 Dual UL 1000V TUV 1000V U0 UL 600V U1 UL 1000V U2 UL 2000V E1 EN 1500V E2 Dual EN 1500V UL 2000V	0 Normal spec 1 New extra thin	0 normal type

### Notes:

- UL cable comes in AWG only
- TUV cable comes in mm<sup>2</sup> only
- Dual cable comes marked with AWG and mm<sup>2</sup>

- VDE 0295-CLASS 2 is 7 strands cable
- Multi wire stranding is 19 strands cable
- VDE 0295-CLASS 5 is high stranded cable with extra flexibility

### PV Cable Assemblies

How to order					
Product family HC Helios cable	Product C H4 A UTX B H4-R	Gender F Female M Male P Mated pair	Connector type C Cable gland M Panel M12 N Panel M14 O Over-mold	Cable size 2 2.5mm <sup>2</sup> /14AWG 4 4.0mm <sup>2</sup> /12AWG 6 6.0mm <sup>2</sup> /10AWG 8 10.0mm <sup>2</sup> /8AWG	Approvals T0 TUV 1000V D0 Dual UL600V TUV 1000V D1 Dual UL 1000V TUV 1000V U0 UL 600V U1 UL 1000V U2 UL 2000V E1 EN 1500V E2 Dual EN 1500V UL 2000V
Cable length(mm)	Cable color B Black-standard R Red L Blue G Grey O Brown OG Orange Y Yellow	End type PS Pre-stripped wire R Ring terminal IR Isolated ring terminal T Tube terminal IT Isolated tube terminal	Variations		

#### Examples of cable assemblies and definition of cable length:



- Other terminals and customized strip lengths are available.
- Please contact us for customer variations.

### Overmolded Junctions



Technical Data	
Certification	IEC 62093, UL 9703
Rated current	50A max
Rated voltage	1000V DC, 1500V DC
Insulation material	Thermoplastic, UL94 V-0
Degree of protection	IP67
Cable range	2.5mm <sup>2</sup> /14AWG~10.0mm <sup>2</sup> /8AWG
Ambient temperature range	-40°C ~ +85°C



- Please contact us for T/X/R Junction cable assembly ordering configurations.

## Hercules II PV Junction Box



### Features:

- Compact size , Pre-potting
- Good heat dissipation
- Breathing hole for pressure balance
- For automatic assembly at PV module side



### How to order

Product family	Product type	Terminals and diodes	Terminal style	Diode rating
HB Helios JB	C Hercules II Junction box	A 4 contacts/3 diodes	A Clamping contacts B Soldering contacts C Snake wiring contacts D Spot welding contacts	A Y J 25A45V B HY 25A45V C Y J 30A45V
Sealing type	Breathing hole	Cable size	Cable length positive (Ln)*	Cable length negative (Lp)*
A O-ring	Y Yes	A 4.0mm <sup>2</sup> /12AWG Dual cable B 4.0mm <sup>2</sup> /12AWG TUV only	A 1000mm B 1100mm C 1200mm D 800mm E 1400mm	A 1000mm B 1100mm C 1200mm D 800mm E 1400mm

### Technical Data

Rated Voltage	1000V DC(TUV), 1000V DC(UL)
Rated current	10A, 13A
Terminal quantity	4 rails
Number of diodes	3
Ribbon connection	Clamping
Sealing type	O-ring
Breathing hole	With
Protection degree	Ip67
Safety class	II
Flame class	UL94 V-0, 5VB
Cable size	4.0mm <sup>2</sup> /12AWG
Connector type	Helios H4
Temperature range	-40°C~85°C

\*Ln: Cable length on negative end

\*Lp: Cable length on positive end

## Hercules III 5T4D PV Junction Box

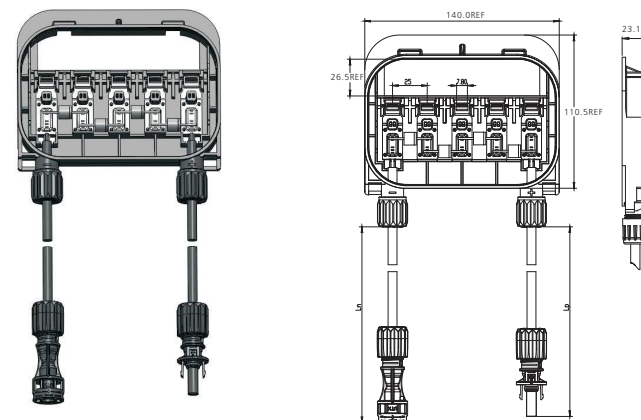

### Features:

- Breathing film for pressure balance
- Wire-locking design for installation of module
- Multi-diode options



### How to order

Product family	Product type	Rated voltage	Rated current & Diode
HB Helios JB	D Hercules 3 J-box	C TUV 1000V/UL 1000V (5T4D type)	C 11A (25PV045)
Cable Length	Variations		
A Ln:1000mm, Lp:1000mm	C old version body and lid		
C Ln:1200mm, Lp:1200mm	D new version body and lid		

### Technical Data

Rated Voltage	1000V DC(TUV), 1000V DC(UL)
Rated current	11A
Terminal quantity	5 rails
Number of diodes	4
Ribbon connection	Clamping
Sealing type	O-ring
Protection degree	IP67
Safety class	II
Flame class	UL94 V-0, 5VA
Cable size	4.0mm <sup>2</sup> /12AWG
Connector type	UTX connector
Pitch distance	25mm
Ribbon width	6.5mm Max
Temperature range	-40°C~+85°C

### Hercules IV PV Junction Box

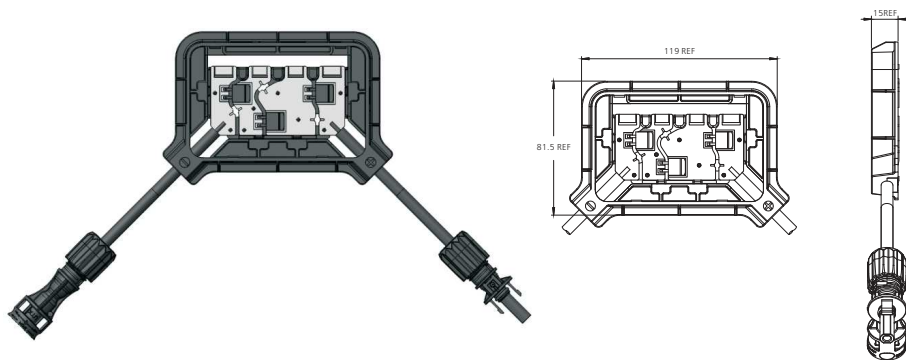

**Features:**

- UL 1500V/ TUV 1500V
- Variable ribbon pitch from 20–22mm
- 45° Orientation mating connectors for saving cable



How to order			
Product family HB Helios JB	Product type E Hercules IV Junction-box	Rated voltage A TUV 1500V& UL 1500V	Rated current & Diode A 15A (TP3045)
Copper plate A Standard	Cable Length* A Ln:1000mm, Lp:1000mm C Ln:1200mm, Lp:1200mm	Variations A Various	

Technical Data	
Rated voltage	1500V DC(TUV), 1500V DC(UL)
Rated current	15A
Terminal quantity	4 rails
Number of diodes	3
Ribbon connection	Spot Welding or Soldering
Sealing type	Potting
Protection degree	IP67
Safety class	II
Flame class	UL94 V-0, 5VA
Cable size	4.0mm <sup>2</sup> /12AWG
Pitch distance	20–22mm
Ribbon width	8mm Max
Temperature range	-40°C~+85°C

\*Ln: Cable length on negative end  
\*Lp: Cable length on positive end  
- Please contact us for additional variations

### Thin-film PV Junction Box

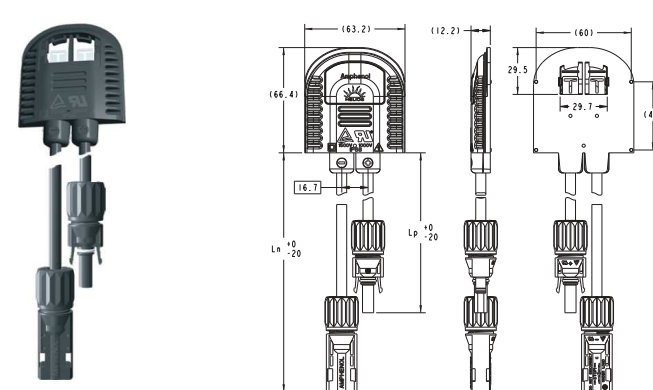

**Features:**

- Low profile
- Over-molded design for better sealing
- SMD for efficient heat dissipation



How to order						
Product family HB Helios JB	Product type T Thin film junction box	Terminals and diodes G 2 contacts/1 diode	Terminal style B Soldering contacts	Diode rating G 5A1000V H 10A1000V J 8A1000V K 20A1200V N Without diode	Sealing type A Potting	Breathing hole N No
Cable size C 2.5 mm <sup>2</sup> /14AWG	Adhesive Y Yes N No	Cable length positive (Ln)* A 1000mm B 900mm	Cable length negative (Lp)* A 1000mm B 900mm	Variations U with UTX connector N no connector		

Technical Data	
Rated voltage	1500V DC(TUV), 1000V DC(UL)
Rated current	Up to 20A ( without diode ), 4A (with diode)
Termination type	Soldering
Protection degree	IP 68
Operation temperature	-40° C --- +90° C
Sealing type	Potting
Flame class	UL94 5V
Diode quantity option	None/ 1

\* Ln:cable length on negative end; Lp:cable length on positive end  
- Please contact us for additional variations



## Herclues Triple Pole PV Junction Box



### Features:

- 3 sets on the right/middle/left of backside panel
- Potting sealing
- Bifacial module's better choice

How to order						
Product family	Product type	Diode rated current	Gender	Cable length	Variations	
HB Helios JB	N Triple pole Junction box	A VSB 1545 B YJ15SQ045 C Diotec 1540 D HY25A45V	F Female end M Male end N Middle one	A 1000mm B 1100mm Y 00mm(middle end)	Blank H4 connector default A UTX connector	

Technical Data	
Rated voltage	TUV1000V/UL1000V
Rated Current	12A
Diode quantity	3
Degree of protection	IP68 (potted)
Flame class	UL94 V-0, 5VB
Safety class	II
Sealing type	Potting
Ribbon connection	Spot welding/Soldering
Connector Type	Helios H4
Cable size	12AWG/4.0mm <sup>2</sup>
Temperature range	-40°C~+85°C

### Ordering example:

- HBNAFA Triple pole Jbox, Female end with VSB1545 diode, 1 meter cable length
- HBNA MA Triple pole Jbox, Male end with VSB1545 diode, 1 meter cable length
- HBNA NY Triple pole Jbox, Middle end with VSB1545 diode

## Hercules Twin PV Junction Box

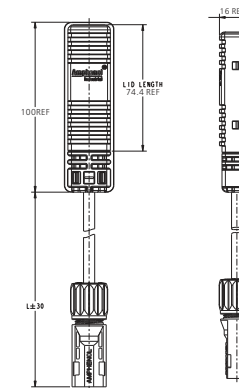

### Features:

- IP 68 degree of protection
- Potting sealing
- Solution for integrated IC/diode in PV module



How to order					
Product Family	Product type	Diode rated current	Gender	Cable length	Variations*
HB Helios JB	I Single pole Junction box L Double pole Junction box	A VSB 1545 B YJ15SQ045 C Diotec 1540 N without diode	F Female M Male	A 1000mm B 1100mm E 300mm	A Variations

Technical Data	
Rated voltage	1000V DC(TUV), 1000V DC(UL)
Rated current	12A
Diode quantity	1
Protection degree	IP68 (Potted)
Flame class	UL94 V-0, 5VB
Safety class	II
Sealing type	Potting
Ribbon connection	Spot welding/Soldering
Connector type	Helios H4
Cable size	4.0mm <sup>2</sup> /12AWG
Temperature range	-40°C~+85°C

\*Please contact us for additional variations

**Tool Kit. P/N: H4TK0000**

Water proof with foam insert and assembly tool.



**Crimping Tool**



**Strip Tool**

**New Crimping Tool**



Order number	Designation	Crimp range		Suitable for			
		mm <sup>2</sup>	AWG	H4		UTX	
				S&F	C&F	S&F	C&F
H4TC0003	Crimping Tool	2.5; 4.0; 6.0	14; 12; 10	X			
UTXTC0003	Crimping Tool	2.5; 4.0; 6.0	14; 12; 10			X	
UTXTC0004	Crimping Tool	4.0; 6.0; 10.0	12; 10; 8		X		X
UTXTC0005	Crimping Tool	2.5; 4.0&6.0	14; 12&10		X		X
UTXTD0003	Crimping Die	2.5; 4.0; 6.0	14; 12; 10	X		X	
H4TP0002	Locator	2.5; 4.0; 6.0	14; 12; 10	X			
UTXTP0002	Locator	2.5; 4.0; 6.0	14; 12; 10			X	
UTXTD0005	Crimping Die	4.0; 6.0; 10.0	12; 10; 8		X		X
UTXTP0004	Double-Locator	4.0; 6.0; 10.0	12; 10; 8		X		X
UTXTD0004	Crimping Die	2.5; 4.0&6.0	14; 12&10		X		X
UTXTP0003	Double-Locator	2.5; 4.0&6.0	14; 12&10		X		X

Order number	Designation	Crimp range		Suitable for			
		mm <sup>2</sup>	AWG	H4		UTX	
				S&F	C&F	S&F	C&F
H4TS0000	Strip Tool	2.5; 4.0; 6.0	14; 12; 10				
H4TC0001	Crimping Tool	2.5; 4.0; 6.0; 10.0	14; 12; 10; 8		X		
H4TC0002	Crimping Tool	2.5; 4.0; 6.0	14; 12; 10	X			
UTXTC0001	Crimping Tool	2.5; 4.0; 6.0; 10.0	14; 12; 10; 8				X
UTXTC0002	Crimping Tool	2.5; 4.0; 6.0	14; 12; 10			X	
H4TD0001	Crimping Die	2.5; 4.0; 6.0; 10.0	14; 12; 10; 8		X		
H4TD0002	Crimping Die	2.5; 4.0; 6.0	14; 12; 10	X		X	
UTXTD0001	Crimping Die	2.5; 4.0; 6.0; 10.0	14; 12; 10; 8				X



UTXTD0003



H4TP0002



UTXTP0002



UTXTD0005



UTXTP0004



UTXTD0004



UTXTP0003

**Tools & Accessories**

Wrench Tool for H4 Connector  
P/N:H4TW0001

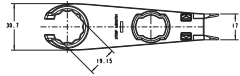

Wrench Tool for Enlarge H4 Connector  
P/N:H4TW0004

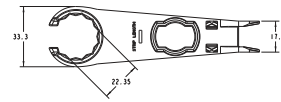

Wrench Tool for H4-R Connector  
P/N:H4TW0003

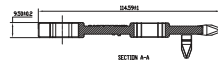

Wrench Tool for UTX Connector  
P/N:UTXTWA001



Wrench Tool for UTX-XL Connector  
P/N:UTXTWL001



**Tools & Accessories**

Universal Unlock Tool  
P/N: H4TU0000

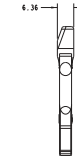
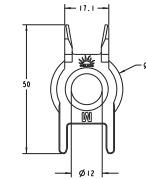

Sealing Cap for Female Connector  
P/N: UTXPF

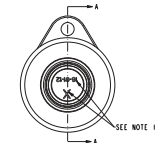
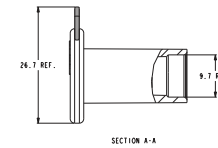

Sealing Cap for Male Connector  
P/N: UTXPM

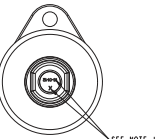
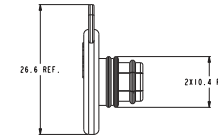
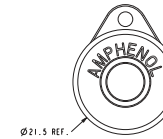

Inspection Tool for H4 Connector  
P/N:H4TT0001

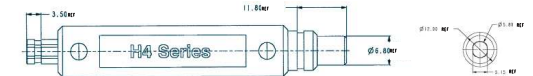

Inspection Tool for UTX Connector  
P/N:UTXTT0001

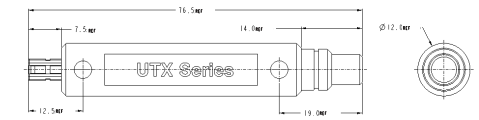

**Tools & Accessories**

Bulkhead wrench tool:  
P/N for M12:H4TM1200; P/N for M14:H4TM1400

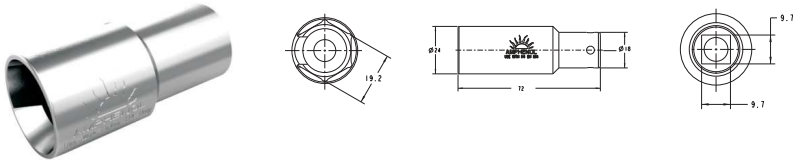

Enlarge cable connector torch wrench  
P/N: H4TTW400

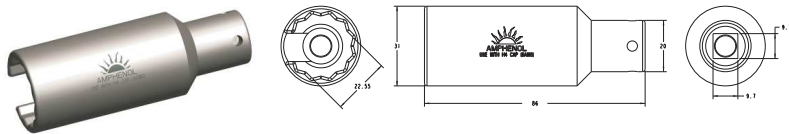

Torch wrench:P/N: H4TTW100

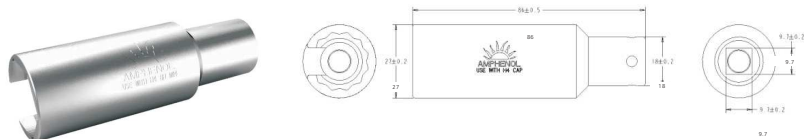

Connector hold tool:P/N: H4TH0000

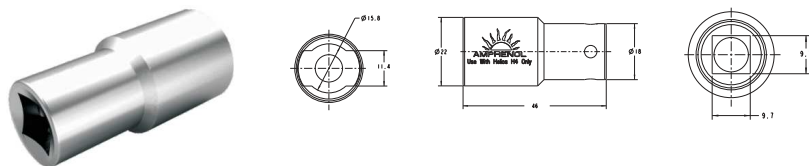

# A

**Amphenol product quality commitment**

Amphenol Industrial Solar Technologies company emphasize innovation in product design and business relationships. By improving customer relationships, product innovation, and manufacturing technology, we strengthen our overall quality and maintain the highest standard of excellence in all aspects of products and service to our customers.

**Customer Satisfaction**  
**Team Work**  
**Innovation & Improvement**





We Not Only Connect Equipment,  
We Connect People!

Компания «Life Electronics» занимается поставками электронных компонентов импортного и отечественного производства от производителей и со складов крупных дистрибьюторов Европы, Америки и Азии.

С конца 2013 года компания активно расширяет линейку поставок компонентов по направлению коаксиальный кабель, кварцевые генераторы и конденсаторы (керамические, пленочные, электролитические), за счёт заключения дистрибьюторских договоров

Мы предлагаем:

- Конкурентоспособные цены и скидки постоянным клиентам.
- Специальные условия для постоянных клиентов.
- Подбор аналогов.
- Поставку компонентов в любых объемах, удовлетворяющих вашим потребностям.
- Приемлемые сроки поставки, возможна ускоренная поставка.
- Доставку товара в любую точку России и стран СНГ.
- Комплексную поставку.
- Работу по проектам и поставку образцов.
- Формирование склада под заказчика.
- Сертификаты соответствия на поставляемую продукцию (по желанию клиента).
- Тестирование поставляемой продукции.
- Поставку компонентов, требующих военную и космическую приемку.
- Входной контроль качества.
- Наличие сертификата ISO.

В составе нашей компании организован Конструкторский отдел, призванный помогать разработчикам, и инженерам.

Конструкторский отдел помогает осуществить:

- Регистрацию проекта у производителя компонентов.
- Техническую поддержку проекта.
- Защиту от снятия компонента с производства.
- Оценку стоимости проекта по компонентам.
- Изготовление тестовой платы монтаж и пусконаладочные работы.



Тел: +7 (812) 336 43 04 (многоканальный)  
Email: org@lifeelectronics.ru