

# TSM900N06

## 60V N-Channel Power MOSFET

**TO-251S  
(IPAK SL)**

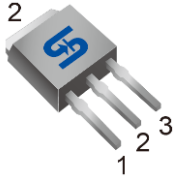

**TO-252  
(DPAK)**

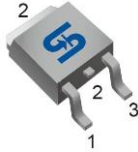

**Pin Definition:**

1. Gate
2. Drain
3. Source

**Key Parameter Performance**

Parameter	Value	Unit
$V_{DS}$	60	V
$R_{DS(on)}$ (max)	$V_{GS} = 10V$	90
	$V_{GS} = 4.5V$	100
$Q_g$	9.3	nC

**SOT-223**



**Ordering Information**

Part No.	Package	Packing
TSM900N06CH X0G	TO-251S	75pcs / Tube
TSM900N06CP ROG	TO-252	2.5kpcs / 13" Reel
TSM900N06CW RPG	SOT-223	2.5kpcs / 13" Reel

**Note:** "G" denotes for Halogen- and Antimony-free as those which contain <900ppm bromine, <900ppm chlorine (<1500ppm total Br + Cl) and <1000ppm antimony compounds

**Block Diagram**

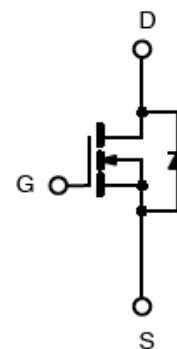

N-Channel MOSFET

**Absolute Maximum Ratings** ( $T_c = 25^\circ C$  unless otherwise noted)

Parameter	Symbol	Limit			Unit	
		IPAK	DPAK	SOT-223		
Drain-Source Voltage	$V_{DS}$	60			V	
Gate-Source Voltage	$V_{GS}$	$\pm 20$			V	
Continuous Drain Current <sup>(Note 1)</sup>	$I_D$	$T_c = 25^\circ C$			A	
		$T_c = 100^\circ C$			A	
Pulsed Drain Current <sup>(Note 1)</sup>	$I_{DM}$	44			A	
Single Pulse Avalanche Energy <sup>(Note 3)</sup>	$E_{AS}$	25			mJ	
Single Pulse Avalanche Current <sup>(Note 3)</sup>	$I_{AS}$	7			A	
Total Power Dissipation	$P_D$	@ $T_c = 25^\circ C$	25	25	4.17	W
Derate above $T_c = 25^\circ C$		0.2	0.2	0.014	W/ $^\circ C$	
Operating Junction Temperature	$T_J$	150			$^\circ C$	
Storage Temperature Range	$T_{STG}$	-55 to +150			$^\circ C$	

### Thermal Performance

Parameter	Symbol	Limit			Unit
		IPAK	DKPAK	SOT-223	
Thermal Resistance - Junction to Case	$R_{\theta JC}$	5	5	30	$^{\circ}C/W$
Thermal Resistance - Junction to Ambient	$R_{\theta JA}$	62	62	70	$^{\circ}C/W$

### Electrical Specifications ( $T_C = 25^{\circ}C$ unless otherwise noted)

Parameter	Conditions	Symbol	Min	Typ	Max	Unit
<b>Static</b>						
Drain-Source Breakdown Voltage	$V_{GS} = 0V, I_D = 250\mu A$	$BV_{DSS}$	60	--	--	V
Drain-Source On-State Resistance	$V_{GS} = 10V, I_D = 6A$	$R_{DS(ON)}$	--	76	90	m $\Omega$
	$V_{GS} = 4.5V, I_D = 3A$		--	87	100	
Gate Threshold Voltage	$V_{DS} = V_{GS}, I_D = 250\mu A$	$V_{GS(TH)}$	1.2	1.8	2.5	V
Zero Gate Voltage Drain Current	$V_{DS} = 60V, V_{GS} = 0V$	$I_{DSS}$	--	--	1	$\mu A$
	$V_{DS} = 48V, T_J = 125^{\circ}C$		--	--	10	
Gate Body Leakage	$V_{GS} = \pm 20V, V_{DS} = 0V$	$I_{GSS}$	--	--	$\pm 100$	$\mu A$
Forward Transconductance	$V_{DS} = 10V, I_D = 3A$	$g_{fs}$	--	4	--	S

<b>Dynamic</b>						
Total Gate Charge <sup>(Note 4,5)</sup>	$V_{DS} = 48V, I_D = 6A, V_{GS} = 10V$	$Q_g$	--	9.3	--	nC
Gate-Source Charge <sup>(Note 4,5)</sup>		$Q_{gs}$	--	2.1	--	
Gate-Drain Charge <sup>(Note 4,5)</sup>		$Q_{gd}$	--	1.8	--	
Input Capacitance	$V_{DS} = 15V, V_{GS} = 0V, f = 1MHz$	$C_{iss}$	--	500	--	pF
Output Capacitance		$C_{oss}$	--	45	--	
Reverse Transfer Capacitance		$C_{rss}$	--	16	--	
Gate Resistance	$V_{GS}=0V, V_{DS}=0V, f=1MHz$	$R_g$	--	2	--	$\Omega$

<b>Switching</b>						
Turn-On Delay Time <sup>(Note 4,5)</sup>	$V_{DD} = 30V, V_{GS} = 10V, R_G = 3.3\Omega, I_D = -1A$	$t_{d(on)}$	--	2.9	--	ns
Turn-On Rise Time <sup>(Note 4,5)</sup>		$t_r$	--	9.5	--	
Turn-Off Delay Time <sup>(Note 4,5)</sup>		$t_{d(off)}$	--	18.4	--	
Turn-Off Fall Time <sup>(Note 4,5)</sup>		$t_f$	--	5.3	--	

<b>Source-Drain Diode Ratings and Characteristic</b>						
Continuous Drain-Source Diode	$V_G = V_D = 0V, \text{Force Current}$	$I_S$	--	--	11	A
Pulse Drain-Source Diode		$I_{SM}$	--	--	44	A
Diode-Source Forward Voltage	$V_{GS} = 0V, I_S = 1A$	$V_{SD}$	--	--	1.2	V
Reverse Recovery Time <sup>(Note 4)</sup>	$V_{GS} = 30V, I_S = 1A$	$t_{rr}$	--	23.2	--	ns
Reverse Recovery Charge <sup>(Note 4)</sup>		$dI_F/dt = 100A/\mu s$	$Q_{rr}$	--	14.3	--

#### Note:

- Limited by maximum junction temperature.
- Repetitive Rating : Pulsed width limited by maximum junction temperature.
- $V_{DD}=25V, V_{GS}=10V, L=1mH, I_{AS}=7A, R_G=25\Omega, \text{Starting } T_J= 25^{\circ}C$
- Pulse test: pulse width  $\leq 300\mu s$ , duty cycle  $\leq 2\%$
- Essentially independent of operating temperature.

### Electrical Characteristics Curve

**Continuous Drain Current vs. T<sub>c</sub>**

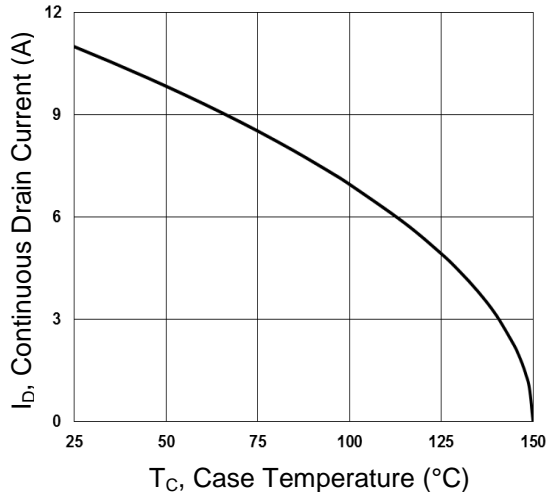

**Normalized R<sub>DS(on)</sub> vs. T<sub>J</sub>**

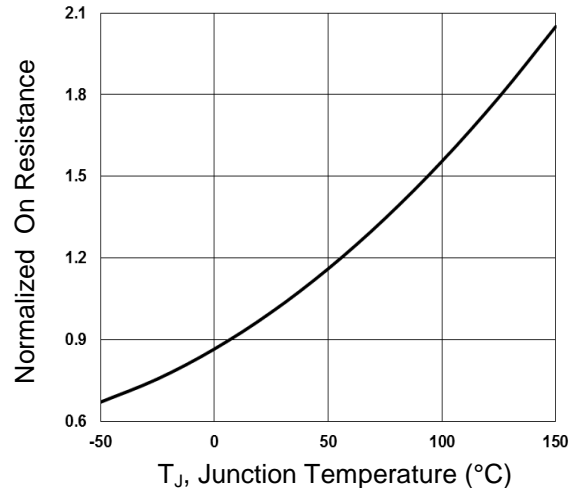

**Normalized V<sub>th</sub> vs. T<sub>J</sub>**

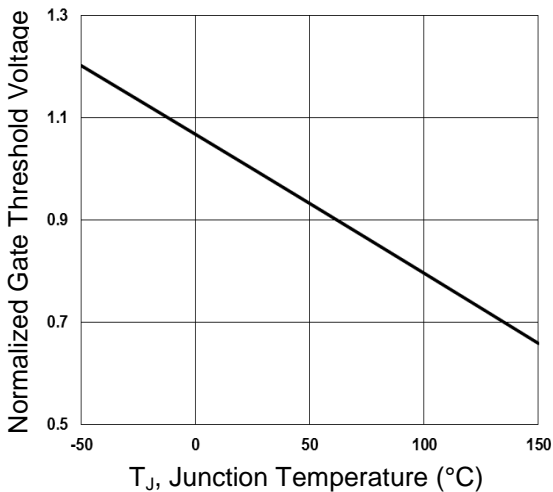

**Gate Charge Waveform**

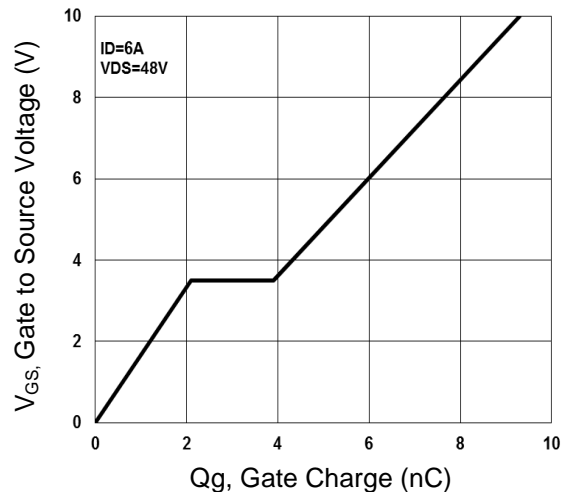

**Normalized Transient Impedance (TO-251S)**

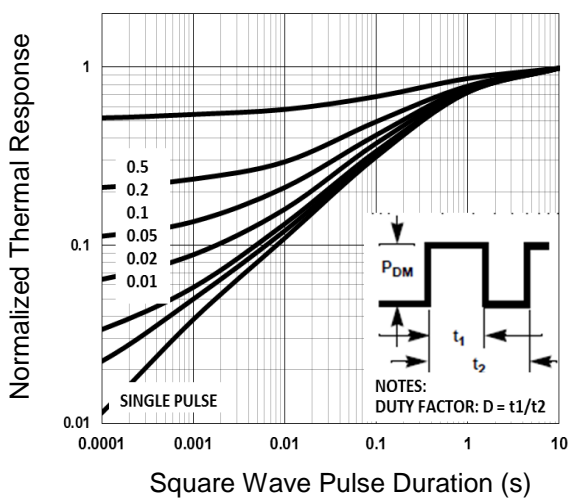

**Maximum Safe Operation Area (TO-251S)**

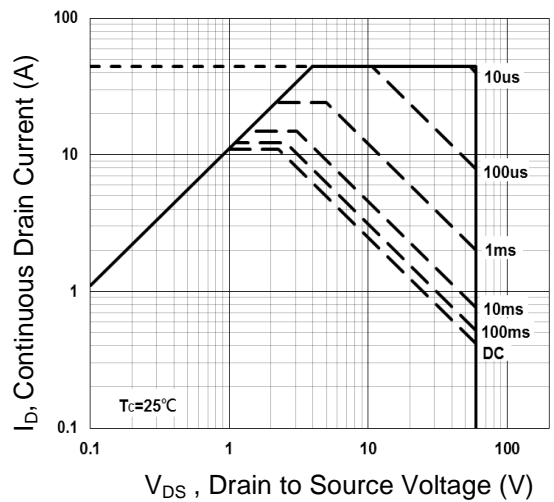

**Electrical Characteristics Curve** ( $T_c=25^\circ\text{C}$ , unless otherwise noted)

**Normalized Transient Impedance (TO-252)**

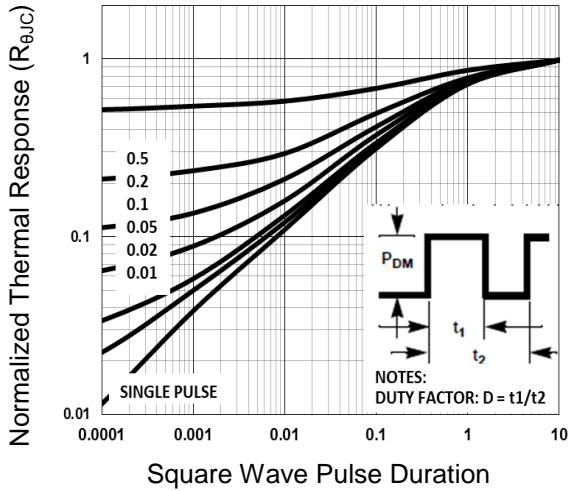

**Maximum Safe Operation Area (TO-252)**

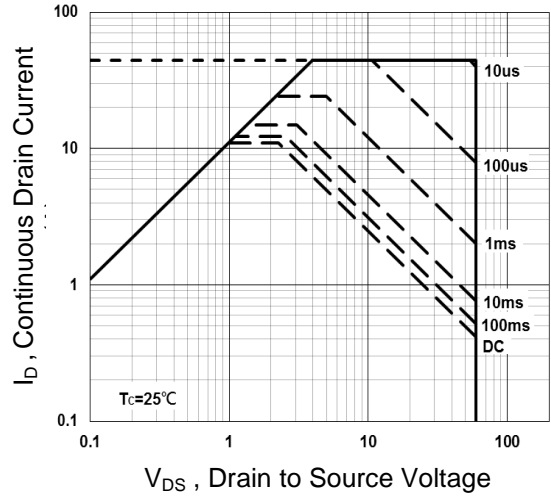

**Normalized Transient Impedance (SOT-223)**

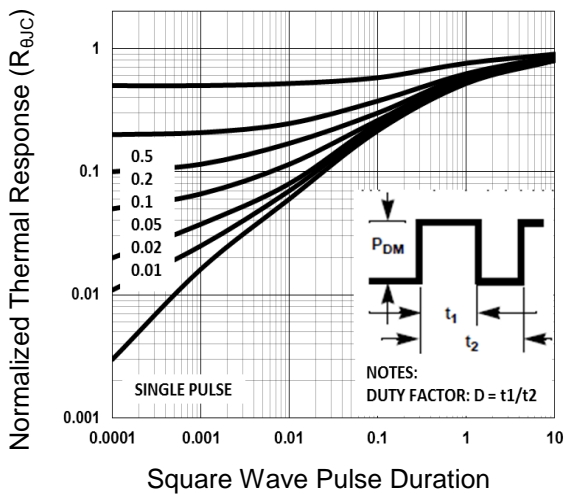

**Maximum Safe Operation Area (SOT-223)**

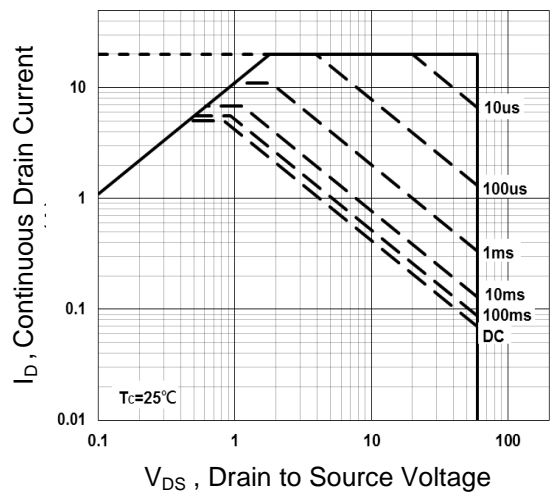



### TO-251S Mechanical Drawing

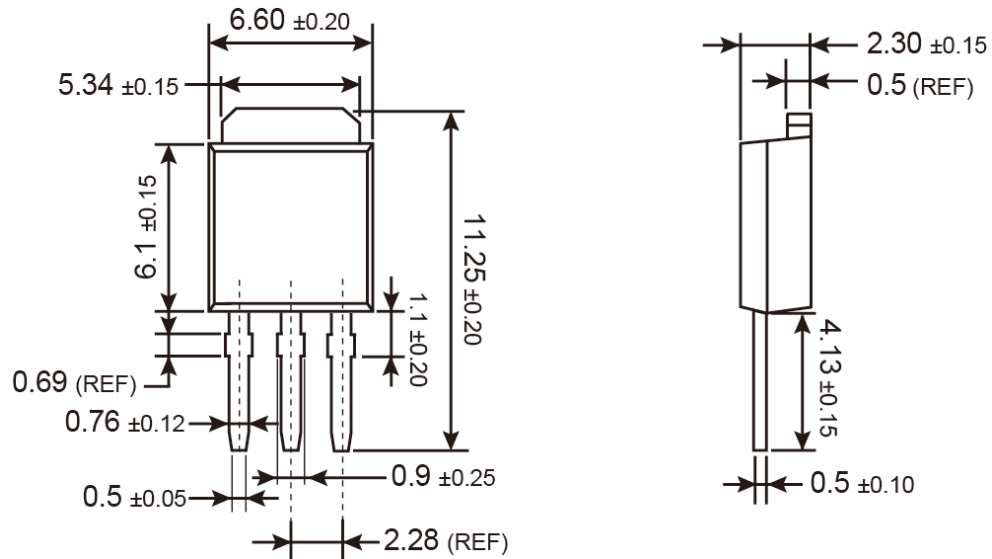

Unit: Millimeters

### Marking Diagram

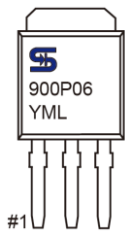

- Y** = Year Code
- M** = Month Code for Halogen Free Product  
(O=Jan, P=Feb, Q=Mar, R=Apr, S=May, T=Jun, U=Jul, V=Aug, W=Sep, X=Oct, Y=Nov, Z=Dec)
- L** = Lot Code



### TO-252 Mechanical Drawing

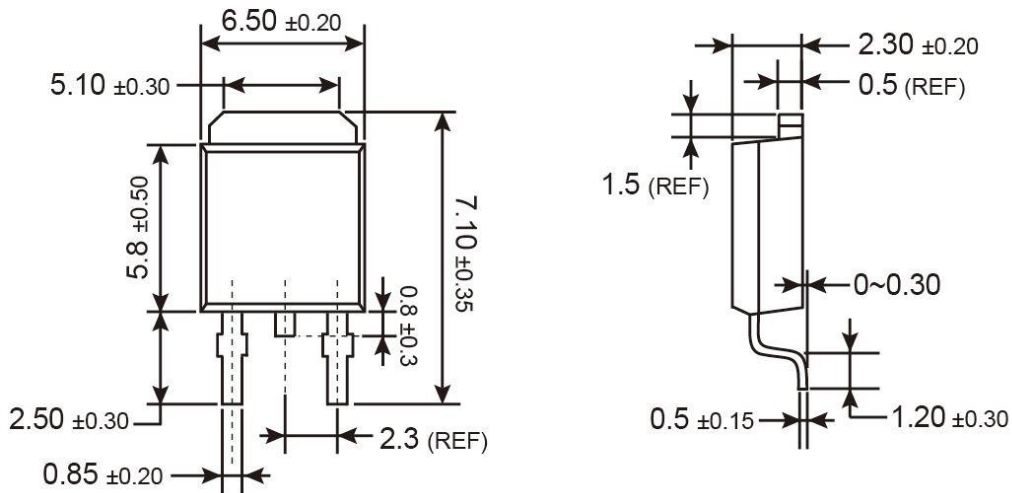

Unit: Millimeters

### Marking Diagram

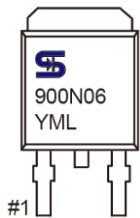

- Y** = Year Code
- M** = Month Code for Halogen Free Product  
(**O**=Jan, **P**=Feb, **Q**=Mar, **R**=Apr, **S**=May, **T**=Jun, **U**=Jul, **V**=Aug, **W**=Sep, **X**=Oct, **Y**=Nov, **Z**=Dec)
- L** = Lot Code



### SOT-223 Mechanical Drawing

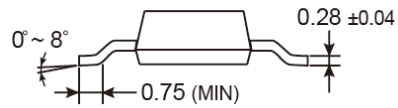
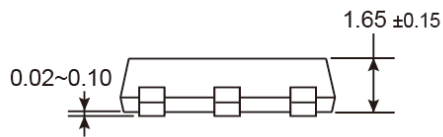
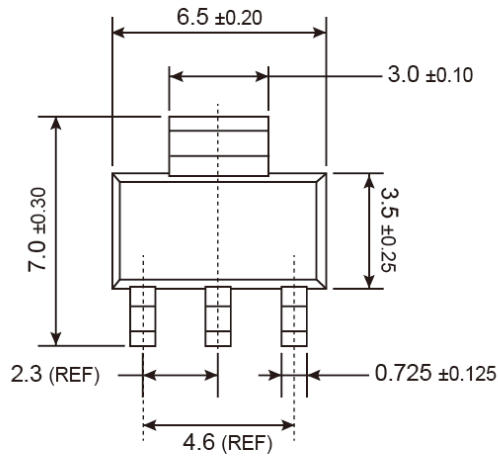

Unit: Millimeters

### Marking Diagram

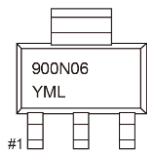

- Y** = Year Code
- M** = Month Code for Halogen Free Product  
(**O**=Jan, **P**=Feb, **Q**=Mar, **R**=Apr, **S**=May, **T**=Jun, **U**=Jul, **V**=Aug, **W**=Sep, **X**=Oct, **Y**=Nov, **Z**=Dec)
- L** = Lot Code

### Notice

Specifications of the products displayed herein are subject to change without notice. TSC or anyone on its behalf, assumes no responsibility or liability for any errors or inaccuracies.

Information contained herein is intended to provide a product description only. No license, express or implied, to any intellectual property rights is granted by this document. Except as provided in TSC's terms and conditions of sale for such products, TSC assumes no liability whatsoever, and disclaims any express or implied warranty, relating to sale and/or use of TSC products including liability or warranties relating to fitness for a particular purpose, merchantability, or infringement of any patent, copyright, or other intellectual property right.

The products shown herein are not designed for use in medical, life-saving, or life-sustaining applications. Customers using or selling these products for use in such applications do so at their own risk and agree to fully indemnify TSC for any damages resulting from such improper use or sale.



Компания «Life Electronics» занимается поставками электронных компонентов импортного и отечественного производства от производителей и со складов крупных дистрибьюторов Европы, Америки и Азии.

С конца 2013 года компания активно расширяет линейку поставок компонентов по направлению коаксиальный кабель, кварцевые генераторы и конденсаторы (керамические, пленочные, электролитические), за счёт заключения дистрибьюторских договоров

Мы предлагаем:

- Конкурентоспособные цены и скидки постоянным клиентам.
- Специальные условия для постоянных клиентов.
- Подбор аналогов.
- Поставку компонентов в любых объемах, удовлетворяющих вашим потребностям.
- Приемлемые сроки поставки, возможна ускоренная поставка.
- Доставку товара в любую точку России и стран СНГ.
- Комплексную поставку.
- Работу по проектам и поставку образцов.
- Формирование склада под заказчика.
- Сертификаты соответствия на поставляемую продукцию (по желанию клиента).
- Тестирование поставляемой продукции.
- Поставку компонентов, требующих военную и космическую приемку.
- Входной контроль качества.
- Наличие сертификата ISO.

В составе нашей компании организован Конструкторский отдел, призванный помогать разработчикам, и инженерам.

Конструкторский отдел помогает осуществить:

- Регистрацию проекта у производителя компонентов.
- Техническую поддержку проекта.
- Защиту от снятия компонента с производства.
- Оценку стоимости проекта по компонентам.
- Изготовление тестовой платы монтаж и пусконаладочные работы.



Тел: +7 (812) 336 43 04 (многоканальный)

Email: [org@lifeelectronics.ru](mailto:org@lifeelectronics.ru)