

REVISION			
REV	DESCRIPTION	DATE	APPROVED
A	REVISED PER ECO-13-013027	8/13/13	I. MYONG

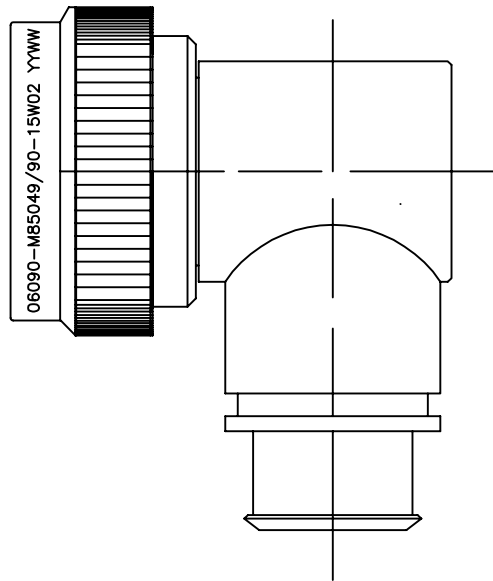

SELF-LOCKING
SHIELD BAND TERMINATION
SHRINK BOOT ACCOMMODATION 90° ADAPTER



NOTES

1. THIS PRODUCT IS DESIGNED TO TERMINATE A BRAIDED CABLE SHIELD AND A HEAT SHRINKABLE LIPPED BOOT TO A CONNECTOR, AND DESIGNED TO MEET PERFORMANCE REQUIREMENT OF AS85049/90.
2. ALL COMPONENTS SHALL BE PACKAGED AND SUPPLIED IN A PLASTIC BAG AND LABELED WITH M85049/90 DESIGNATION e.g. M85049/90-15W02.
3. PART SUPPLIED WITH STANDARD DETENTED SELF-LOCKING WHICH PROVIDES A POSITIVE AUDIBLE DETENTED COUPLING.
4. THIS ADAPTER MATES TO CONNECTOR MIL-DTL-38999 SERIES III AND MIL-DTL-38999 SERIES IV.
5. FOR MATERIAL AND FINISH INFORMATION REFER TO R85049.
FOR ALTERNATIVE MATERIALS AND PLATING FINISHES CONTACT TE CONNECTIVITY.

If this document is printed it becomes uncontrolled. Check for the latest revision

© 2013 Tyco Electronics Corporation. All rights reserved.

Raychem Adapters
CUSTOMER DRAWING

UNLESS OTHERWISE SPECIFIED DIMENSIONS ARE IN INCHES.		 TE Connectivity					
DECIMALS: .000 ± .005 .00 ± .010 .0 ± .015	ANGLES: ± 0° 30'						
TYCO ELECTRONICS RESERVES THE RIGHT TO AMEND THIS DRAWING AT ANYTIME. USERS SHOULD EVALUATE THE SUITABILITY OF THE PRODUCT FOR THEIR APPLICATION.		TITLE: BACKSHELL, 90°, SELF-LOCKING SHIELD BAND TERMINATION, SHRINK BOOT ACCOMMODATION, CATEGORY 3B					
		DRAWING NO: R85049/90					
DRAWN: T. NGUYEN	CAD FILE: R85049-90_CD.dwg	CAGE CODE: 06090	RPN: N/A	SIZE: A	SCALE: 	THIRD ANGLE PROJ. 	SHEET: 1_OF_3

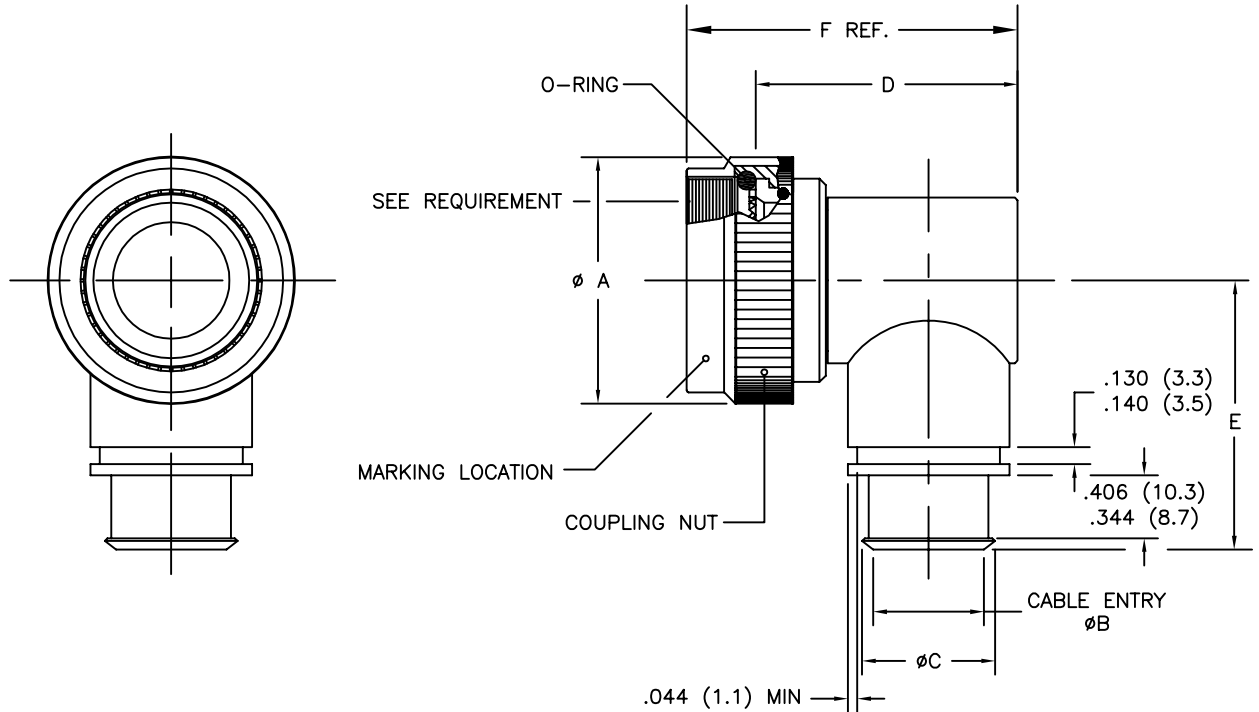

PART NUMBERING

R85049/90 - 15 W 02

- SPECIFICATION SHEET _____
- CONFIGURATION: _____
 - (DASH) DETENTED SELF-LOCKING
- ORDER NO. _____
- FINISH _____
- ENTRY SIZE _____

If this document is printed it becomes uncontrolled. Check for the latest revision

© 2013 Tyco Electronics Corporation. All rights reserved.

Raychem Adapters
CUSTOMER DRAWING

		DRAWING NO:				
		R85049/90				
CAD FILE:	CAGE CODE:	RPN:	SIZE:	SCALE:	THIRD ANGLE PROJ.	SHEET:
R85049-90_CD.DWG	06090	N/A	A	1:1	AS SHOWN	2_OF_3

TABLE I – SHELL SIZE AND DIMENSIONS

ORDER NUMBER	SHELL SIZE	A MAX DIA	B DIA ±.010 ENTRY SIZE		C DIA REF	
			O2	O3	O2	O3
9	A	.858 (21.8)	N/A	.250 (6.4)	N/A	.395 (10.0)
11	B	.984 (25.0)	N/A	.312 (7.9)	N/A	.457 (11.6)
13	C	1.157 (29.4)	.312 (7.9)	.438 (11.1)	.457 (11.6)	.583 (14.8)
15	D	1.279 (32.5)	.438 (11.1)	.562 (14.3)	.583 (14.8)	.707 (18.0)
17	E	1.406 (35.7)	.500 (12.7)	.625 (15.9)	.645 (16.4)	.770 (19.6)
19	F	1.516 (38.5)	.625 (15.9)	.750 (19.1)	.770 (19.6)	.895 (22.7)
21	G	1.642 (41.7)	.625 (15.9)	.812 (20.6)	.770 (19.6)	.957 (24.3)
23	H	1.768 (44.9)	.688 (17.5)	.938 (23.8)	.829 (21.1)	1.083 (27.5)
25	J	1.889 (48.0)	.750 (19.1)	1.000 (25.4)	.895 (22.7)	1.145 (29.1)



TABLE II – SHELL SIZE AND DIMENSIONS

ORDER NUMBER	SHELL SIZE	D MAX DIA	E MAX DIA	F (REF)
9	A	1.375 (34.9)	1.417 (36.0)	1.623 (41.2)
11	B	1.437 (36.5)	1.480 (37.6)	1.685 (42.8)
13	C	1.562 (39.7)	1.553 (39.4)	1.810 (46.0)
15	D	1.687 (42.8)	1.614 (41.0)	1.935 (49.1)
17	E	1.750 (44.4)	1.678 (42.6)	1.998 (50.8)
19	F	1.875 (47.6)	1.773 (45.0)	2.123 (53.9)
21	G	1.938 (49.2)	1.796 (45.6)	2.186 (55.5)
23	H	2.062 (52.4)	1.859 (47.2)	2.310 (58.7)
25	J	2.125 (54.0)	1.919 (48.7)	2.373 (60.3)

If this document is printed it becomes uncontrolled. Check for the latest revision

© 2013 Tyco Electronics Corporation. All rights reserved.

Raychem Adapters
CUSTOMER DRAWING

 TE Connectivity		DRAWING NO: R85049/90			
CAD FILE: R85049-90_CD.DWG	CAGE CODE: 06090	RPN: N/A	SIZE: A	SCALE: 	THIRD ANGLE PROJ. 
					SHEET: 3_OF_3

Компания «Life Electronics» занимается поставками электронных компонентов импортного и отечественного производства от производителей и со складов крупных дистрибьюторов Европы, Америки и Азии.

С конца 2013 года компания активно расширяет линейку поставок компонентов по направлению коаксиальный кабель, кварцевые генераторы и конденсаторы (керамические, пленочные, электролитические), за счёт заключения дистрибьюторских договоров

Мы предлагаем:

- Конкурентоспособные цены и скидки постоянным клиентам.
- Специальные условия для постоянных клиентов.
- Подбор аналогов.
- Поставку компонентов в любых объемах, удовлетворяющих вашим потребностям.
- Приемлемые сроки поставки, возможна ускоренная поставка.
- Доставку товара в любую точку России и стран СНГ.
- Комплексную поставку.
- Работу по проектам и поставку образцов.
- Формирование склада под заказчика.
- Сертификаты соответствия на поставляемую продукцию (по желанию клиента).
- Тестирование поставляемой продукции.
- Поставку компонентов, требующих военную и космическую приемку.
- Входной контроль качества.
- Наличие сертификата ISO.

В составе нашей компании организован Конструкторский отдел, призванный помогать разработчикам, и инженерам.

Конструкторский отдел помогает осуществить:

- Регистрацию проекта у производителя компонентов.
- Техническую поддержку проекта.
- Защиту от снятия компонента с производства.
- Оценку стоимости проекта по компонентам.
- Изготовление тестовой платы монтаж и пусконаладочные работы.



Тел: +7 (812) 336 43 04 (многоканальный)

Email: org@lifeelectronics.ru