

General Specifications

Electrical Capacity (Resistive Load)

Switching Rating:	100mA @ 5V DC
Nonswitching Rating:	100mA @ 50V DC

Other Ratings

Contact Resistance:	80 milliohms maximum for circuit; 30 milliohms maximum for contact point
Insulation Resistance:	1,000 megohms minimum @ 250V DC
Dielectric Strength:	250V AC minimum for 1 minute minimum
Mechanical Life:	20,000 detent operations minimum
Electrical Life:	20,000 detent operations minimum
	Note: A detent operation is one actuator position operation or stepping. 20,000 detent operations = 1,250 cycles for hexadecimal devices or 2,000 cycles for decimal devices. A cycle is one 360° rotation.
Nominal Operating Torque:	.061 kgf/cm (.846 oz/in)
Contact Timing:	Nonshorting (break-before-make)

Materials & Finishes

Actuator:	Glass fiber reinforced polyamide
Housing:	Glass fiber reinforced polyamide (UL94V-0)
O-ring:	Nitrile butadiene rubber
Base:	Glass fiber reinforced polyamide (UL94V-0)
Movable Contact:	Beryllium copper with gold plating
Stationary Contacts:	Brass with gold plating
Terminals:	Brass with gold plating

Environmental Data

Operating Temperature Range:	-25°C through +85°C (-13°F through +185°F)
Humidity:	90 ~ 95% humidity for 100 hours @ 40°C (104°F)
Vibration:	10 ~ 55Hz with peak-to-peak amplitude of 1.5mm traversing the frequency range & returning in 1 minute; 3 right angled directions for 2 hours
Shock:	50G (490m/s ²) acceleration (tested in 6 right angled directions, with 5 shocks in each direction)

Processing

Soldering:	Reflow Soldering: See Profile B in Supplement section. Note: During Reflow Soldering process, set the switch to the following position: ND3FR10, ND3FR16, ND3KR10, ND3KR16: 0 position; ND3FC10, ND3KC10: 7 position; ND3FC16, ND3KC16: F position. Manual Soldering: See Profile B in Supplement section.
Cleaning:	Automated cleaning. See Cleaning Specifications in Supplement section.

Standards & Certifications

Flammability Standards:	UL94V-0 rated housing & base The ND3 Series rotaries have not been tested for UL recognition or CSA certification. These switches are designed for use in a low-voltage, low-current, logic-level circuit. When used as intended in a logic-level circuit, the results do not produce hazardous energy.
--------------------------------	--

Distinctive Characteristics

Sealed construction prevents contact contamination and allows vapor phase and IR reflow soldering. Sealed design accomplished with seals between the actuator and housing and between housing and base.

Highly visible legends and choice of screwdriver or shaft actuation to provide trouble-free code setting.

Detent mechanism designed for crisp, positive action for accurate switch setting.

Bifurcated, spring loaded contacts give unmatched logic-level reliability.

Heat tolerant resin used for body meets UL flammability rating of 94V-0 and maintains switch reliability through vapor phase and infrared convection reflow soldering.

Gull-winged terminals ensure mechanical stability during soldering and simplified solder joint inspection.

.100" (2.54mm) terminal grid spacing between pin centers, plus 3-by-3 terminal arrangement for pad layout pattern equivalent to industry standard.

Epoxy sealed terminals lock out flux, solvents, and other contaminants.

Packaging in tape-reel or partitioned tray. Tape-reel packaging meets EIA-481-2 Standard.

Coplanarity: all considered surfaces must lie between two parallel planes that are a maximum distance apart of .0059" (0.15mm). (Additional coplanarity details in Terms and Acronyms in the Supplement section.)



Actual Size



TYPICAL SWITCH ORDERING EXAMPLE



DESCRIPTION FOR TYPICAL ORDERING EXAMPLE

ND3KC16B



ACTUATION

F Screwdriver Actuated

K Shaft Actuated

Actuator colors:
White for real coded
Red for complement coded



Actuator colors:
White for real coded
Red for complement coded



Actuators are fully rotational in either direction.

TRUTH TABLES (CIRCUITS & POSITIONS)

Terminal No. (Output)	Actuator Position ● = ON	10 Decimal										16 Hexadecimal															
		0	1	2	3	4	5	6	7	8	9	0	1	2	3	4	5	6	7	8	9	A	B	C	D	E	F
R Real Coded Model Numbers: ND3FR, ND3KR	1		●		●		●		●		●		●		●		●		●		●		●		●		●
	2			●	●			●	●					●	●					●	●					●	●
	4					●	●	●	●						●	●					●	●				●	●
	8									●	●									●	●					●	●
C Complement Coded Model Numbers: ND3FC, ND3KC	1	●		●				●		●		●							●		●				●		
	2	●	●			●	●			●	●			●	●				●	●				●	●		
	4	●	●	●						●	●			●	●				●	●				●	●		
	8	●	●	●	●					●	●			●	●				●	●				●	●		

TYPICAL SWITCH DIMENSIONS

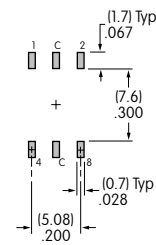
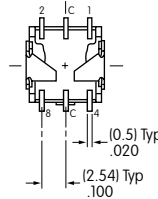
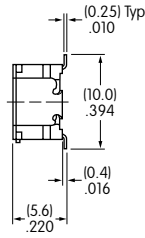

Screwdriver Actuated • Upright

Terminal numbers are not on switch.

ND3FR10P

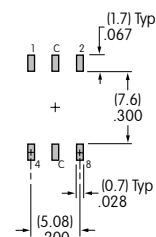
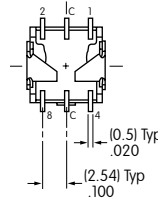

Shaft Actuated • Upright

Terminal numbers are not on switch.

ND3KC16P

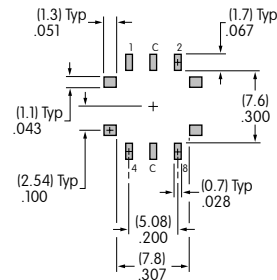
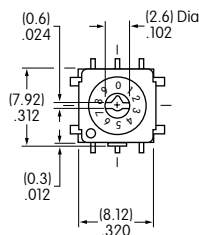

Screwdriver Actuated • Upright with Bracket

Terminal numbers are not on switch.

ND3FR10B

TYPICAL SWITCH DIMENSIONS

Shaft Actuated • Upright with Bracket

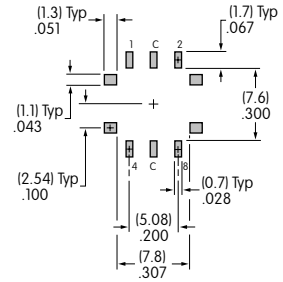
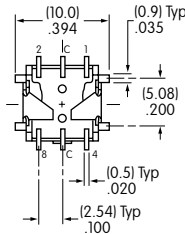
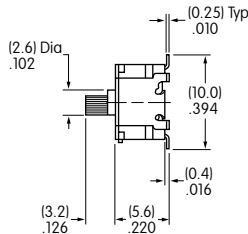
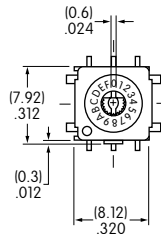

ND3KC16B

Terminal numbers are not on switch.

Screwdriver Actuated • Right Angle

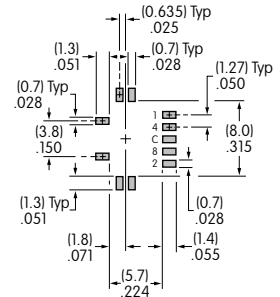
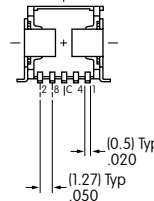
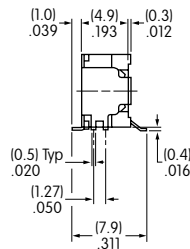
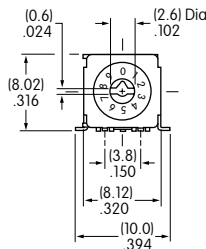

ND3FC10H

Terminal numbers are not on switch.

Shaft Actuated • Right Angle

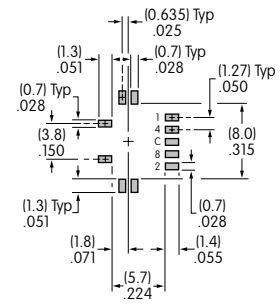
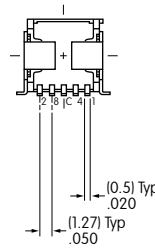
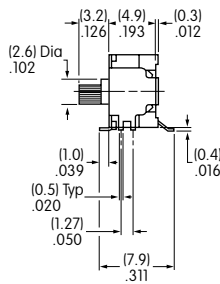
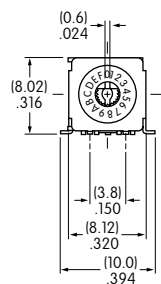

ND3KR16H

Terminal numbers are not on switch.

Toggles

Rockers

Pushbuttons

Illuminated PB

Programmable

Keylocks

Rotaries

Slides

Tactiles

Tilt

Touch

Indicators

Accessories

Supplement

PACKAGING

R Tape-Reel Packaging for Upright & Right Angle

Switches must be ordered in 500-piece increments when tape-reel packaging is selected.

This packaging meets EIA-481-2 Standard for "16mm and 24mm Embossed Carrier Taping of Surface Mount Components for Automatic Handling."



No Code Partitioned Tray for Upright & Right Angle Any Quantity

If the ND3 is ordered in less than 500-piece increments, the switches are packaged in a partitioned tray. No code is required.



- Toggles
- Rockers
- Pushbuttons
- Illuminated PB
- Programmable
- Keylocks
- Rotaries**
- Slides
- Tactiles
- Tilt
- Touch
- Indicators
- Accessories
- Supplement

PACKAGING (CONTINUED)

For Upright & Upright with Bracket (Codes P & B with F Actuator)

Each tape-reel of 550 pockets contains 500 switches
 Minimum Leader Length: 9.05" (230mm) Minimum Trailer Length: 6.30" (160mm)



Reel Dimensions

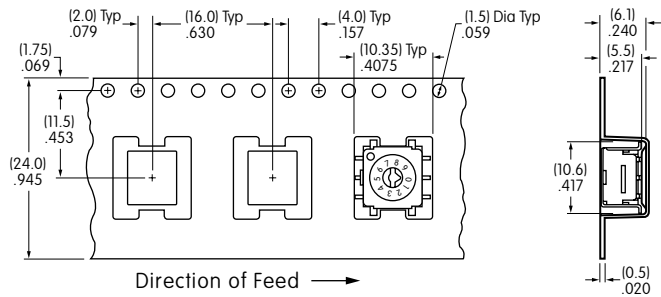

Tape Dimensions

For Upright & Upright with Bracket (Codes P & B with K Actuator)

Each tape-reel of 530 pockets contains 500 switches
 Minimum Leader Length: 9.05" (230mm) Minimum Trailer Length: 6.30" (160mm)

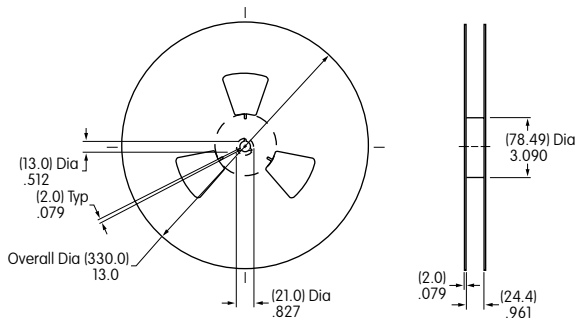

Reel Dimensions

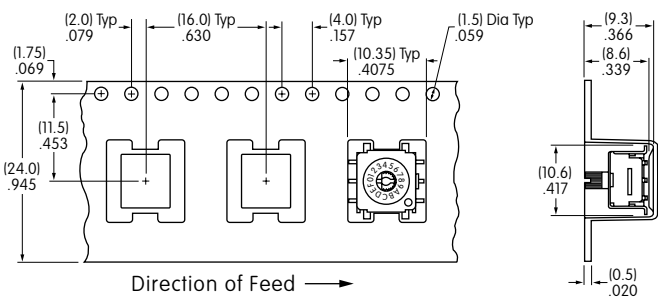

Tape Dimensions

For Right Angle (Code H with F or K Actuator)

Each tape-reel of 550 pockets contains 500 switches
 Minimum Leader Length: 9.05" (230mm) Minimum Trailer Length: 6.30" (160mm)



Reel Dimensions

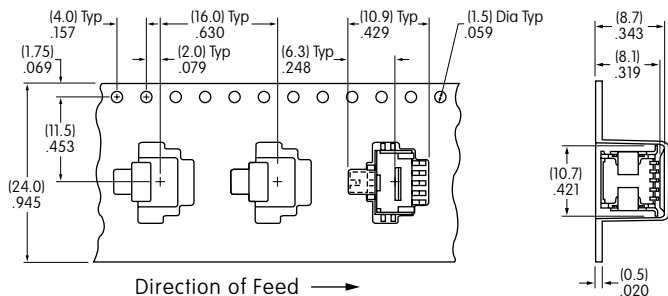

Tape Dimensions

Компания «Life Electronics» занимается поставками электронных компонентов импортного и отечественного производства от производителей и со складов крупных дистрибьюторов Европы, Америки и Азии.

С конца 2013 года компания активно расширяет линейку поставок компонентов по направлению коаксиальный кабель, кварцевые генераторы и конденсаторы (керамические, пленочные, электролитические), за счёт заключения дистрибьюторских договоров

Мы предлагаем:

- Конкурентоспособные цены и скидки постоянным клиентам.
- Специальные условия для постоянных клиентов.
- Подбор аналогов.
- Поставку компонентов в любых объемах, удовлетворяющих вашим потребностям.
- Приемлемые сроки поставки, возможна ускоренная поставка.
- Доставку товара в любую точку России и стран СНГ.
- Комплексную поставку.
- Работу по проектам и поставку образцов.
- Формирование склада под заказчика.
- Сертификаты соответствия на поставляемую продукцию (по желанию клиента).
- Тестирование поставляемой продукции.
- Поставку компонентов, требующих военную и космическую приемку.
- Входной контроль качества.
- Наличие сертификата ISO.

В составе нашей компании организован Конструкторский отдел, призванный помогать разработчикам, и инженерам.

Конструкторский отдел помогает осуществить:

- Регистрацию проекта у производителя компонентов.
- Техническую поддержку проекта.
- Защиту от снятия компонента с производства.
- Оценку стоимости проекта по компонентам.
- Изготовление тестовой платы монтаж и пусконаладочные работы.



Тел: +7 (812) 336 43 04 (многоканальный)

Email: org@lifeelectronics.ru