

HB-2X2-RS

~10° spot beam

TECHNICAL SPECIFICATIONS:

Dimensions	50.0 mm
Height	10 mm
Fastening	screw
ROHS compliant	yes 

MATERIAL SPECIFICATIONS:

Component	Type	Material	Colour	Finish
HB-2X2-RS	Multi-lens	PMMA	clear	







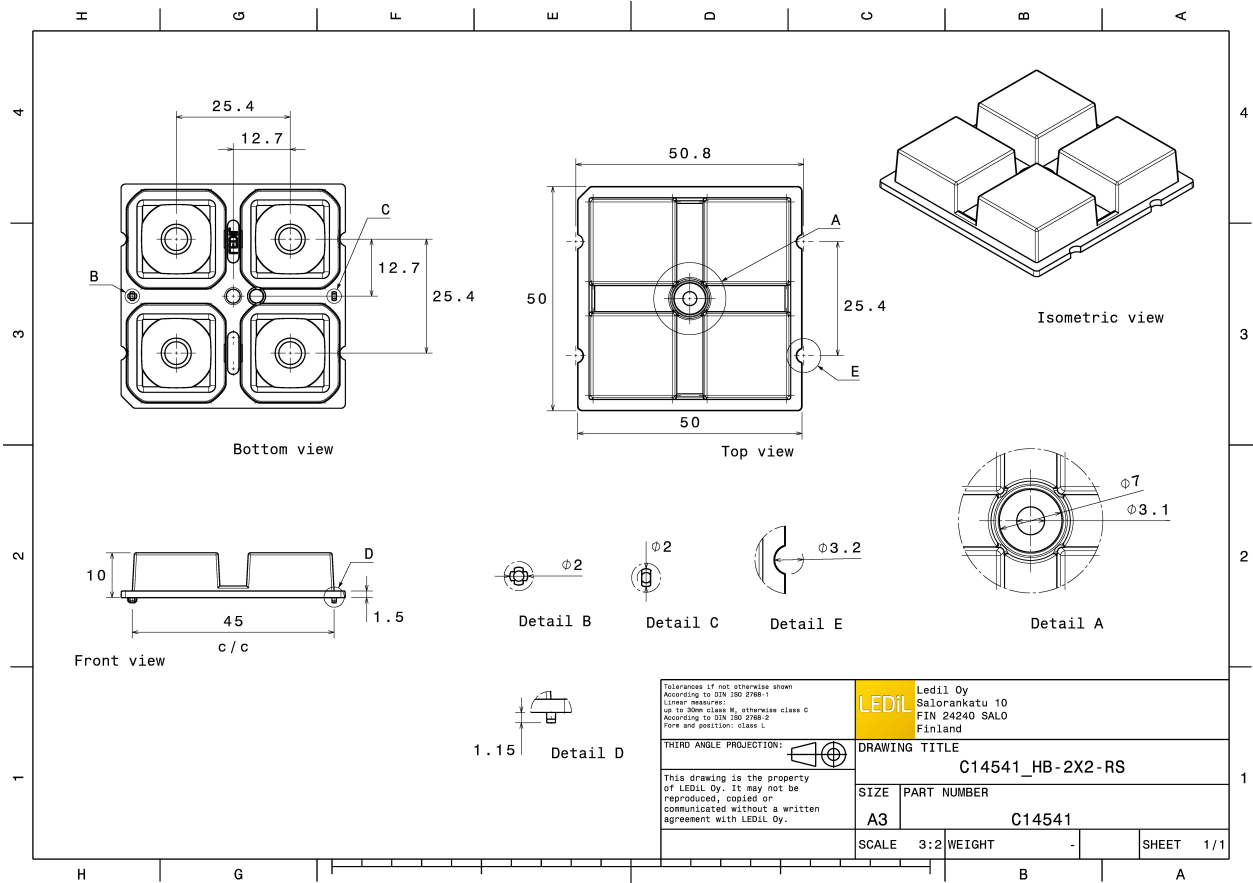

ORDERING INFORMATION:

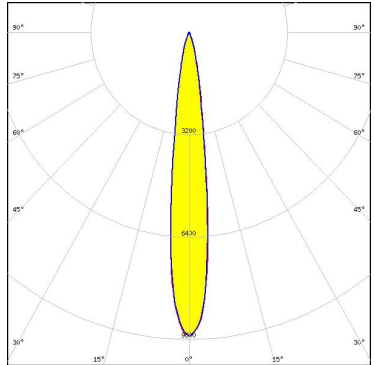
Component	Qty in box	MOQ	MPQ	Box weight (kg)
C14541_HB-2X2-RS » Box size: 480 x 280 x 300 mm	800	160	160	10.2

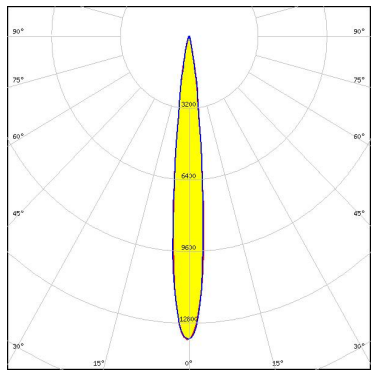

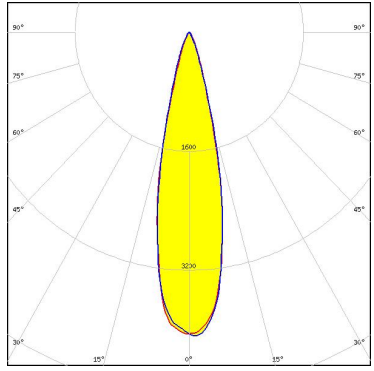
PHOTOMETRIC DATA (MEASURED):

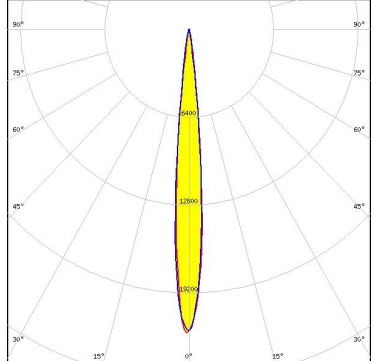
<p>COMET ELECTRONICS</p> <p>LED QUICK FLUX XTP 2x6 xxx LS G5 FWHM 14.0° Efficiency 94 % Peak intensity 9.5 cd/lm LEDs/each optic 1 Light colour White Required components:</p>		
<p>CREE</p> <p>LED XD16 FWHM 11.0° Efficiency 93 % Peak intensity 13.5 cd/lm LEDs/each optic 1 Light colour White Required components:</p>		
<p>CREE</p> <p>LED XHP35 HD FWHM 24.0° Efficiency 89 % Peak intensity 4.1 cd/lm LEDs/each optic 1 Light colour White Required components:</p>		
<p>CREE</p> <p>LED XP-E2 FWHM 10.0° Efficiency 94 % Peak intensity 22.1 cd/lm LEDs/each optic 1 Light colour White Required components:</p>		

PHOTOMETRIC DATA (MEASURED):



LED XP-G2
 FWHM 14.0°
 Efficiency 94 %
 Peak intensity 11.8 cd/Im
 LEDs/each optic 1
 Light colour White
 Required components:

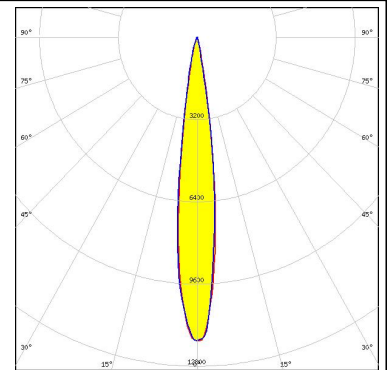

LED XP-L HI
 FWHM 13.0°
 Efficiency 94 %
 Peak intensity 11.6 cd/Im
 LEDs/each optic 1
 Light colour White
 Required components:

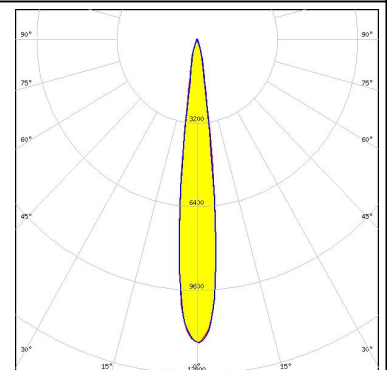

LED XP-L2
 FWHM 21.0°
 Efficiency 94 %
 Peak intensity 4.5 cd/Im
 LEDs/each optic 1
 Light colour White
 Required components:

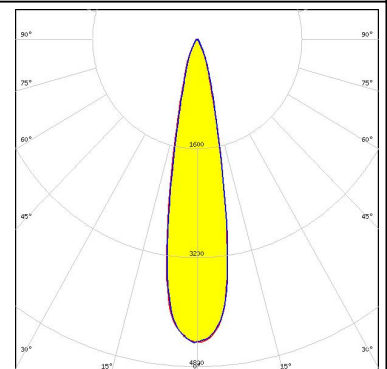
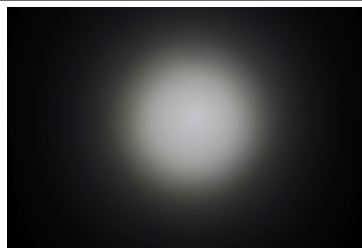

LED LUXEON V2
 FWHM 15.0°
 Efficiency 94 %
 Peak intensity 9.5 cd/Im
 LEDs/each optic 1
 Light colour White
 Required components:

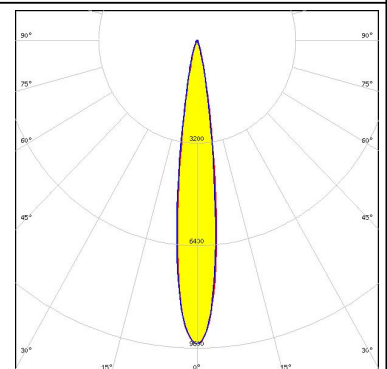

PHOTOMETRIC DATA (MEASURED):



LED SST-10-B130
 FWHM 12.0°
 Efficiency 96 %
 Peak intensity 15.9 cd/Im
 LEDs/each optic 1
 Light colour Deep Red
 Required components:

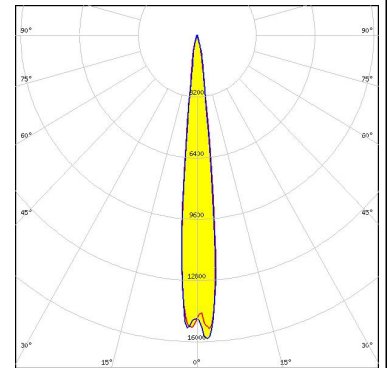

LED NVSW219D
 FWHM 17.0°
 Efficiency 94 %
 Peak intensity 8.6 cd/Im
 LEDs/each optic 1
 Light colour White
 Required components:

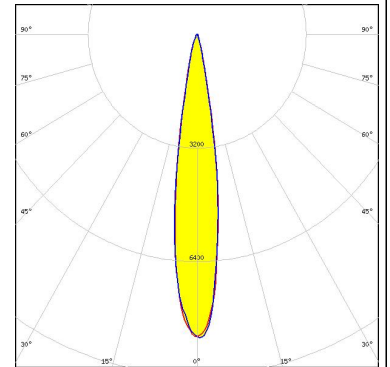
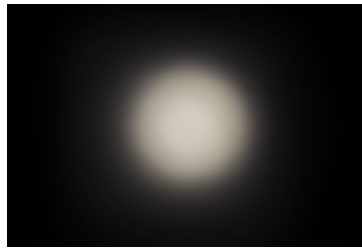



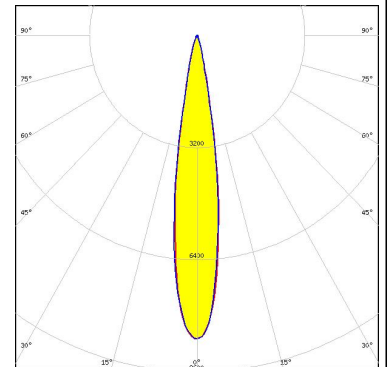
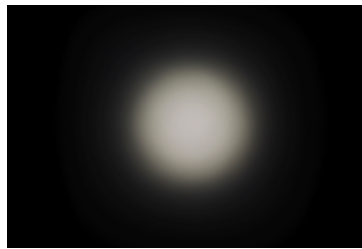

LED NVSW219F
 FWHM 17.0°
 Efficiency 94 %
 Peak intensity 8.7 cd/Im
 LEDs/each optic 1
 Light colour White
 Required components:

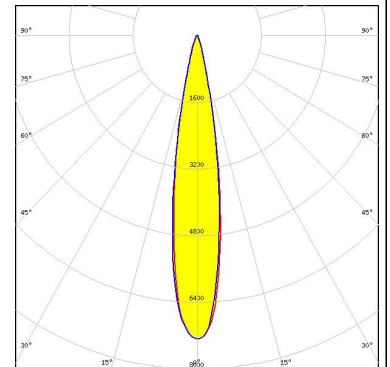
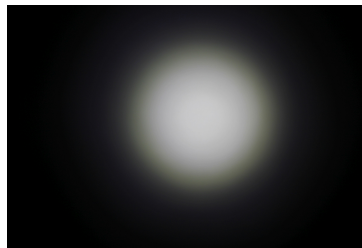

LED NVSW319B
 FWHM 18.0°
 Efficiency 94 %
 Peak intensity 7.3 cd/Im
 LEDs/each optic 1
 Light colour White
 Required components:

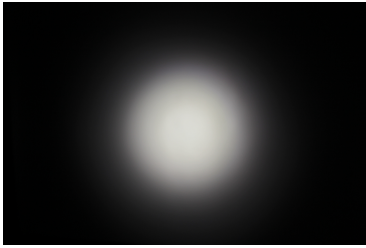
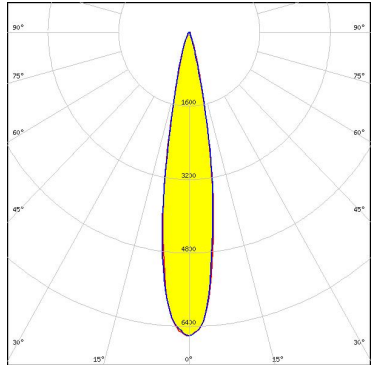

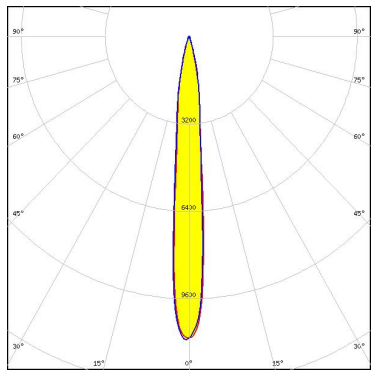
PHOTOMETRIC DATA (MEASURED):

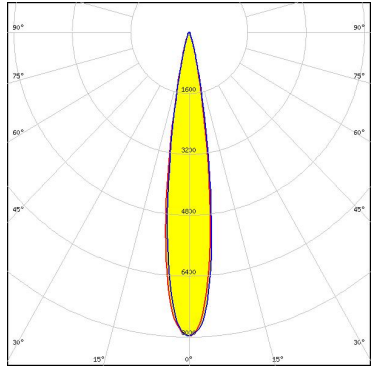
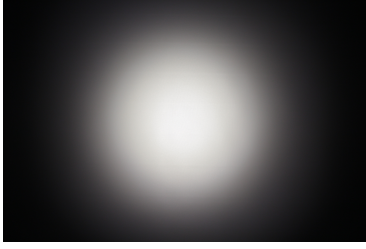
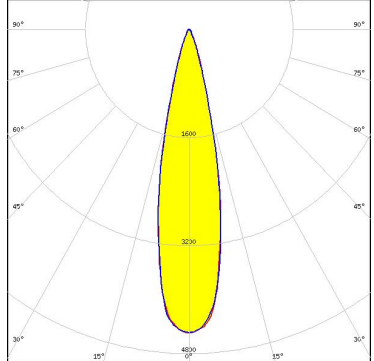
<p>NICHIA</p> <p>LED NVSW3x9A FWHM 19.0° Efficiency 94 % Peak intensity 6.6 cd/lm LEDs/each optic 1 Light colour White Required components:</p>		
<p>NICHIA</p> <p>LED NVSxE21A FWHM 11.0° Efficiency 89 % Peak intensity 11.1 cd/lm LEDs/each optic 1 Light colour White Required components:</p>		
<p>NICHIA</p> <p>LED NVSxx19B/NVSxx19C FWHM 17.0° Efficiency 93 % Peak intensity 8 cd/lm LEDs/each optic 1 Light colour White Required components:</p>		
<p>NICHIA</p> <p>LED NWSx229A FWHM 23.0° Efficiency 94 % Peak intensity 4.5 cd/lm LEDs/each optic 1 Light colour White Required components:</p>		

PHOTOMETRIC DATA (MEASURED):

OSRAM

Opto Semiconductors

LED OSLOM Square CSSRM2/CSSRM3
 FWHM 15.0°
 Efficiency 90 %
 Peak intensity 11 cd/lm
 LEDs/each optic 1
 Light colour White
 Required components:

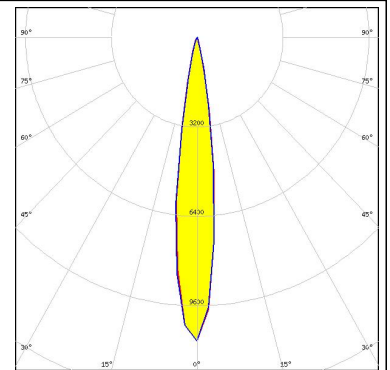
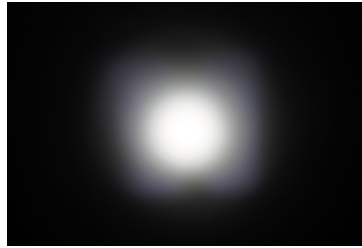

PHILIPS

LED Fortimo FastFlex LED 2x8 DA G4
 FWHM 13.0°
 Efficiency 93 %
 Peak intensity 12.5 cd/lm
 LEDs/each optic 1
 Light colour White
 Required components:

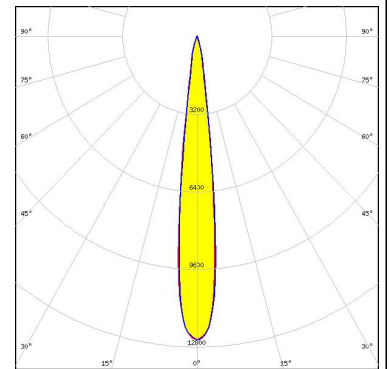

SAMSUNG

LED HiLOM RH16 (LH351C)
 FWHM 17.0°
 Efficiency 94 %
 Peak intensity 8.1 cd/lm
 LEDs/each optic 1
 Light colour White
 Required components:

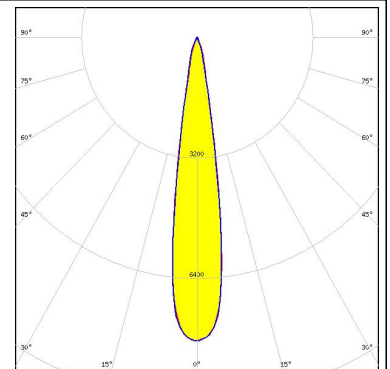
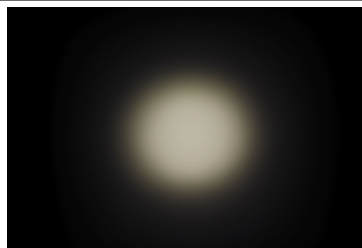

SAMSUNG

LED LH351B
 FWHM 17.0°
 Efficiency 89 %
 Peak intensity 8 cd/lm
 LEDs/each optic 1
 Light colour White
 Required components:

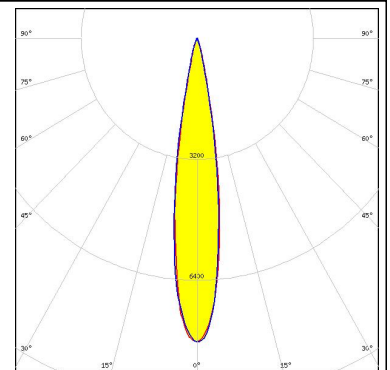

PHOTOMETRIC DATA (MEASURED):

SAMSUNG

LED LH351C
 FWHM 18.0°
 Efficiency 94 %
 Peak intensity 7.9 cd/Im
 LEDs/each optic 1
 Light colour White
 Required components:

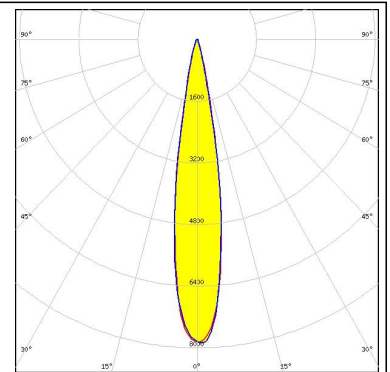

SAMSUNG

LED LH351D
 FWHM 22.0°
 Efficiency 94 %
 Peak intensity 4.9 cd/Im
 LEDs/each optic 1
 Light colour White
 Required components:

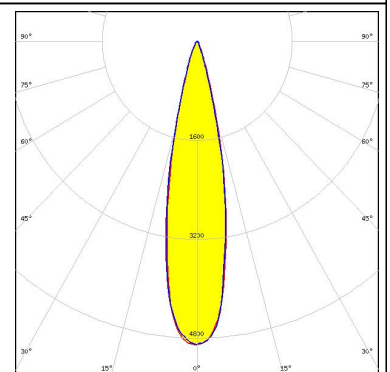
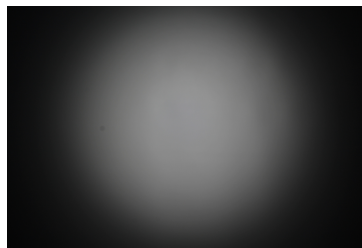

SEOUL SEMICONDUCTOR

LED Z5M3
 FWHM 16.0°
 Efficiency 94 %
 Peak intensity 7.8 cd/Im
 LEDs/each optic 1
 Light colour White
 Required components:

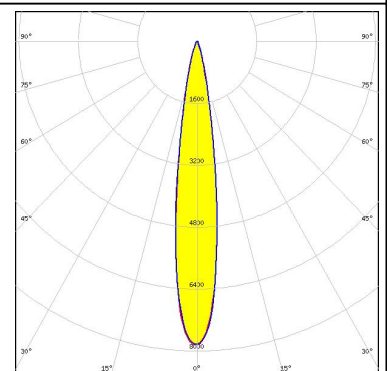
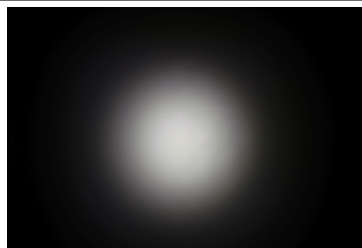

SEOUL SEMICONDUCTOR

LED Z5M4
 FWHM 17.0°
 Efficiency 96 %
 Peak intensity 7.4 cd/Im
 LEDs/each optic 1
 Light colour White
 Required components:

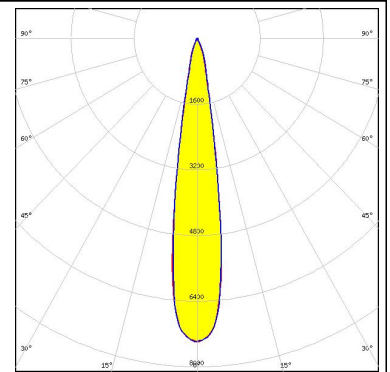

PHOTOMETRIC DATA (MEASURED):

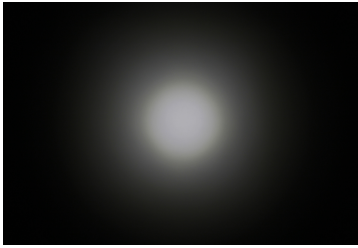
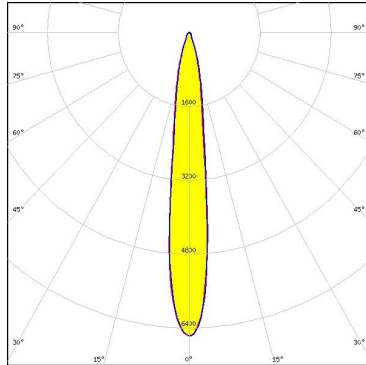
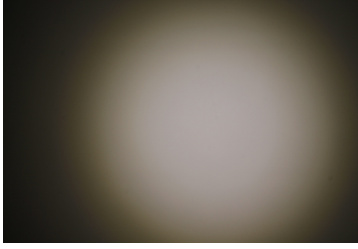
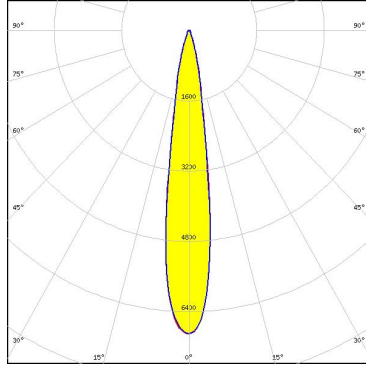
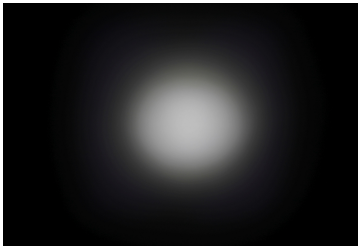
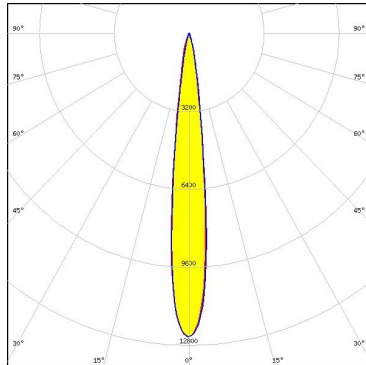
<p>SEOL SEOL SEMICONDUCTOR</p> <p>LED Z8Y22 FWHM 14.0° Efficiency 94 % Peak intensity 6.6 cd/lm LEDs/each optic 1 Light colour White Required components:</p>		
<p>SEOL SEOL SEMICONDUCTOR</p> <p>LED Z8Y22P FWHM 16.0° Efficiency 93 % Peak intensity 6.9 cd/lm LEDs/each optic 1 Light colour White Required components:</p>		
<p>TRIDONIC</p> <p>LED RLE 2x4 2000lm HP EXC2 OTD FWHM 13.0° Efficiency 94 % Peak intensity 12.5 cd/lm LEDs/each optic 1 Light colour White Required components:</p>		
<p>TRIDONIC</p> <p>LED RLE 2x8 4000lm HP EXC2 OTD FWHM 13.0° Efficiency 94 % Peak intensity 12.5 cd/lm LEDs/each optic 1 Light colour White Required components:</p>		

PHOTOMETRIC DATA (MEASURED):

TRIDONIC

LED RLE G1 49x121mm 2000lm xxx EXC OTD
 FWHM 13.0°
 Efficiency 94 %
 Peak intensity 10.9 cd/lm
 LEDs/each optic 1
 Light colour White
 Required components:

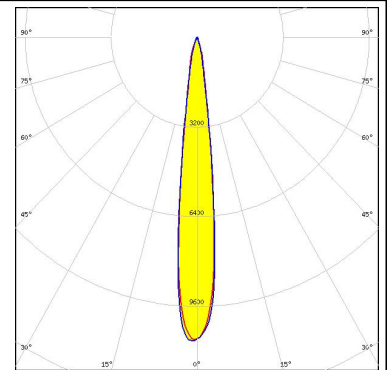

TRIDONIC

LED RLE G1 49x133mm 2000lm xxx EXC OTD
 FWHM 13.0°
 Efficiency 94 %
 Peak intensity 10.9 cd/lm
 LEDs/each optic 1
 Light colour White
 Required components:

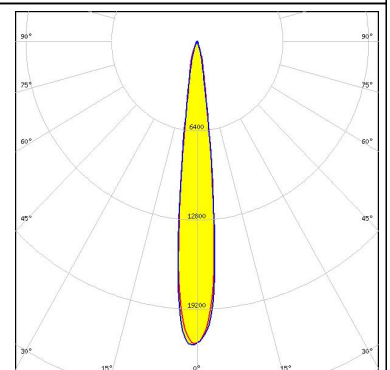

TRIDONIC

LED RLE G1 49x223mm 4000lm xxx EXC OTD
 FWHM 13.0°
 Efficiency 94 %
 Peak intensity 10.9 cd/lm
 LEDs/each optic 1
 Light colour White
 Required components:

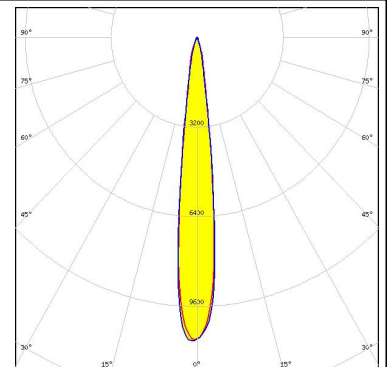
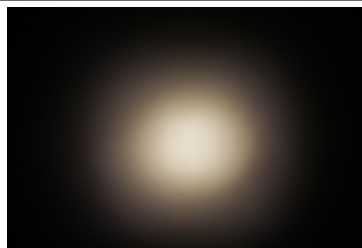

TRIDONIC

LED RLE G1 49x245mm 4000lm xxx EXC OTD
 FWHM 13.0°
 Efficiency 94 %
 Peak intensity 10.9 cd/lm
 LEDs/each optic 1
 Light colour White
 Required components:

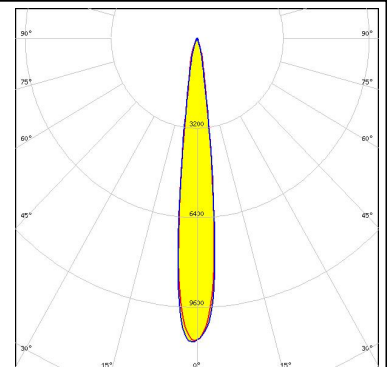
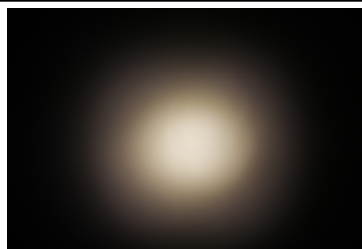

PHOTOMETRIC DATA (SIMULATED):



LED XHP35 HI
 FWHM 14.0°
 Efficiency 93 %
 Peak intensity 9.9 cd/lm
 LEDs/each optic 1
 Light colour White
 Required components:

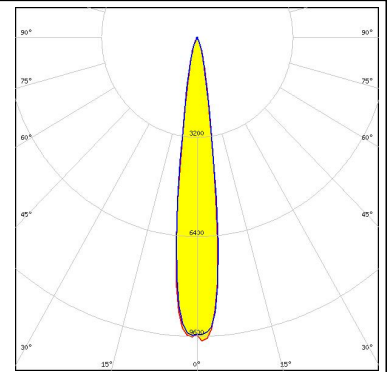

LED XM-L
 FWHM 19.0°
 Efficiency 92 %
 Peak intensity 5.6 cd/lm
 LEDs/each optic 1
 Light colour White
 Required components:

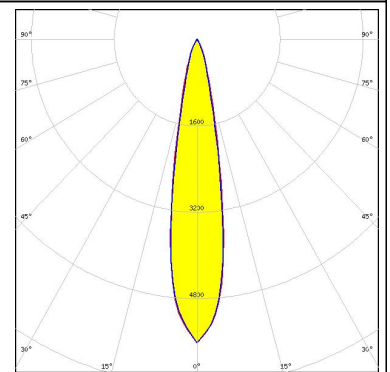

LED XM-L2
 FWHM 18.0°
 Efficiency 94 %
 Peak intensity 6.9 cd/lm
 LEDs/each optic 1
 Light colour White
 Required components:

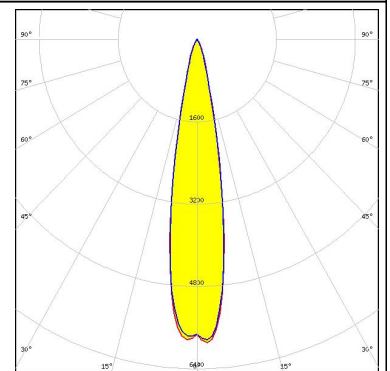

LED XP-G
 FWHM 13.0°
 Efficiency 93 %
 Peak intensity 12.1 cd/lm
 LEDs/each optic 1
 Light colour White
 Required components:

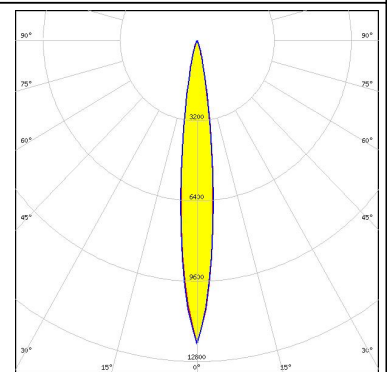

PHOTOMETRIC DATA (SIMULATED):



LED XP-G2
 FWHM 12.0°
 Efficiency 92 %
 Peak intensity 12.8 cd/lm
 LEDs/each optic 1
 Light colour White

Required components:

Transparent protective cover

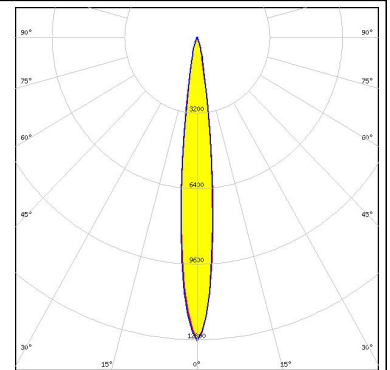

LED XP-G2 HE
 FWHM 16.0°
 Efficiency 94 %
 Peak intensity 7.3 cd/lm
 LEDs/each optic 1
 Light colour White

Required components:

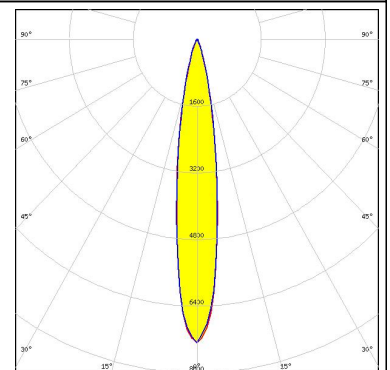

LED XP-G3
 FWHM 16.0°
 Efficiency 94 %
 Peak intensity 7.9 cd/lm
 LEDs/each optic 1
 Light colour White

Required components:

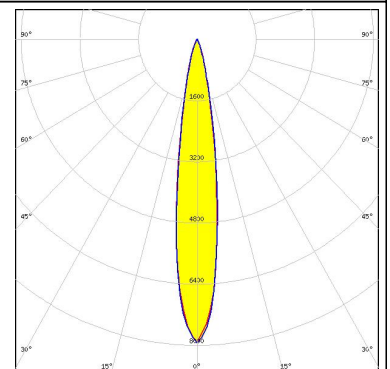

LED XP-L HD
 FWHM 19.0°
 Efficiency 94 %
 Peak intensity 6.1 cd/lm
 LEDs/each optic 1
 Light colour White

Required components:

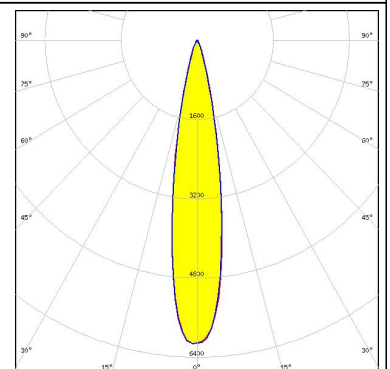

PHOTOMETRIC DATA (SIMULATED):



LED XP-L2
 FWHM 20.0°
 Efficiency 89 %
 Peak intensity 4.7 cd/lm
 LEDs/each optic 1
 Light colour White

Required components:

Transparent protective cover

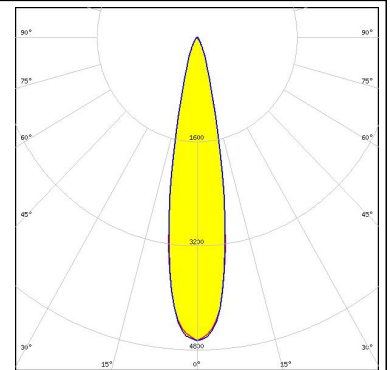

LED XQ-E HI
 FWHM 8.0°
 Efficiency 94 %
 Peak intensity 28.3 cd/lm
 LEDs/each optic 1
 Light colour White

Required components:



LED LUXEON C
 FWHM 11.0°
 Efficiency 94 %
 Peak intensity 16.2 cd/lm
 LEDs/each optic 1
 Light colour White

Required components:

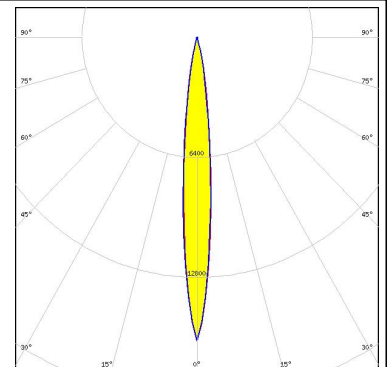

LED LUXEON IR Domed 150
 FWHM 11.0°
 Efficiency 94 %
 Peak intensity 19.1 cd/lm
 LEDs/each optic 1
 Light colour White

Required components:

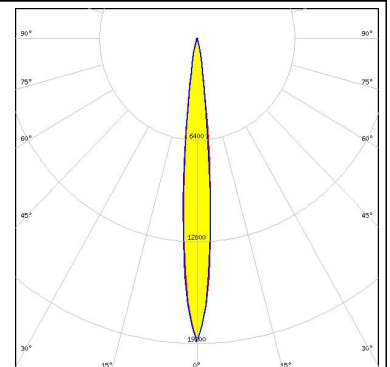

PHOTOMETRIC DATA (SIMULATED):

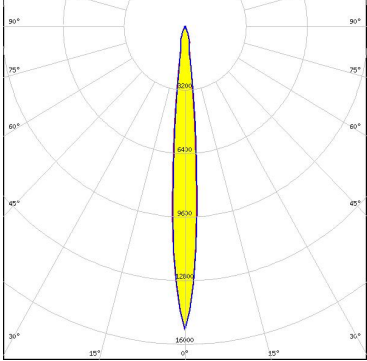
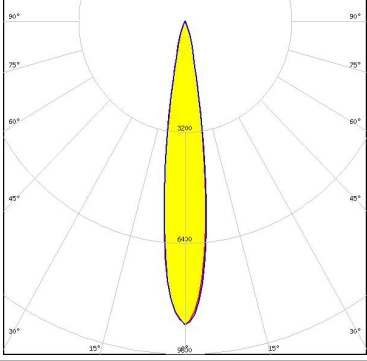
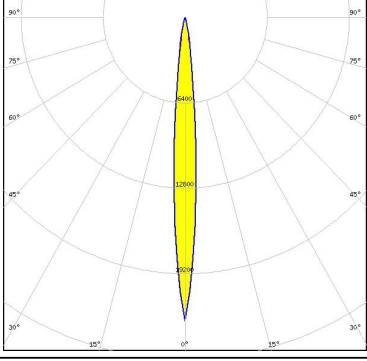
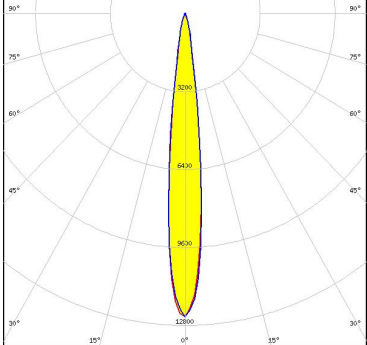
<p>LUMILEDS</p> <p>LED: LUXEON IR Domed 60 FWHM: 10.0° Efficiency: 93 % LEDs/each optic: 1 Light colour: White Required components:</p>	
<p>NICHIA</p> <p>LED: NVSxx19B/NVSxx19C FWHM: 16.0° Efficiency: 94 % Peak intensity: 8.8 cd/lm LEDs/each optic: 1 Light colour: White Required components:</p>	
<p>OSRAM <small>Opto Semiconductors</small></p> <p>LED: OSCONIQ P 3030 FWHM: 8.0° Efficiency: 95 % Peak intensity: 22.7 cd/lm LEDs/each optic: 1 Light colour: White Required components:</p>	
<p>OSRAM <small>Opto Semiconductors</small></p> <p>LED: OSCONIQ P 3737 (2W version) FWHM: 12.0° Efficiency: 90 % Peak intensity: 12.5 cd/lm LEDs/each optic: 1 Light colour: White Required components:</p> <p>Transparent protective cover</p>	

PHOTOMETRIC DATA (SIMULATED):

OSRAM

Opto Semiconductors

LED OSCONIQ P 3737 (2W version)
 FWHM 12.0°
 Efficiency 95 %
 Peak intensity 13.5 cd/lm
 LEDs/each optic 1
 Light colour White
 Required components:

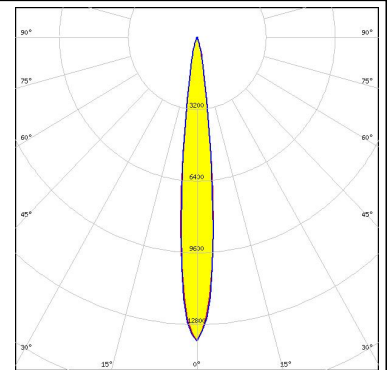

OSRAM

Opto Semiconductors

LED OSLON SSL 80
 FWHM 8.2°
 Efficiency 94 %
 Peak intensity 21 cd/lm
 LEDs/each optic 1
 Light colour White
 Required components:

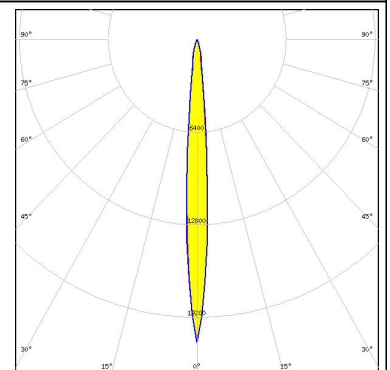

OSRAM

Opto Semiconductors

LED SFH 4715AS
 FWHM 9.2°
 Efficiency %
 LEDs/each optic 1
 Light colour IR
 Required components:

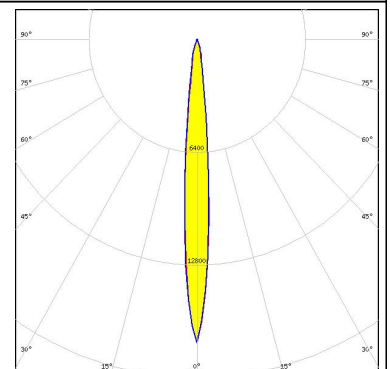

SAMSUNG

LED LH231B
 FWHM 16.0°
 Efficiency 94 %
 Peak intensity 8 cd/lm
 LEDs/each optic 4
 Light colour White
 Required components:

PHOTOMETRIC DATA (SIMULATED):

SAMSUNG

LED LH231B
 FWHM 16.0°
 Efficiency 95 %
 Peak intensity 8.3 cd/lm
 LEDs/each optic 1
 Light colour White
 Required components:

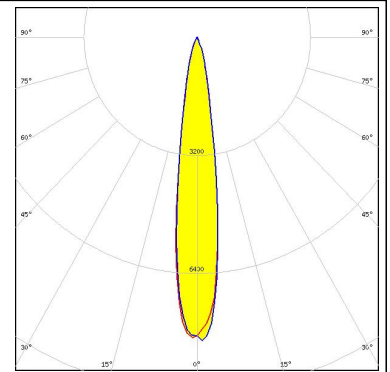

SAMSUNG

LED LH231B
 FWHM 16.0°
 Efficiency 95 %
 Peak intensity 8.4 cd/lm
 LEDs/each optic 1
 Light colour White
 Required components:

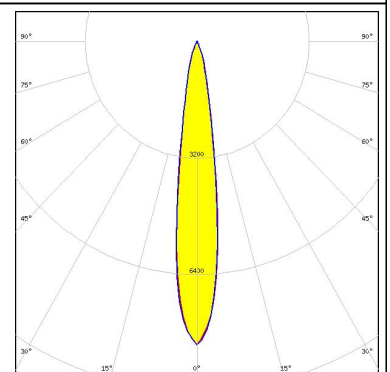

SEOUL SEMICONDUCTOR

LED Z5M1/Z5M2
 FWHM 13.0°
 Efficiency 92 %
 Peak intensity 12.1 cd/lm
 LEDs/each optic 1
 Light colour White
 Required components:

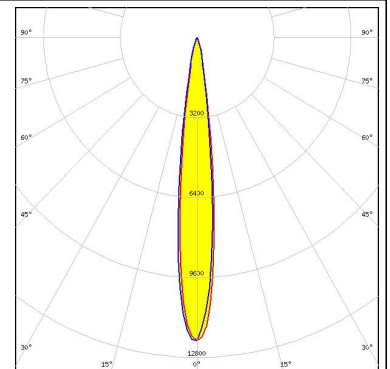

SEOUL SEMICONDUCTOR

LED Z8Y22T
 FWHM 15.0°
 Efficiency 94 %
 Peak intensity 8.6 cd/lm
 LEDs/each optic 1
 Light colour White
 Required components:

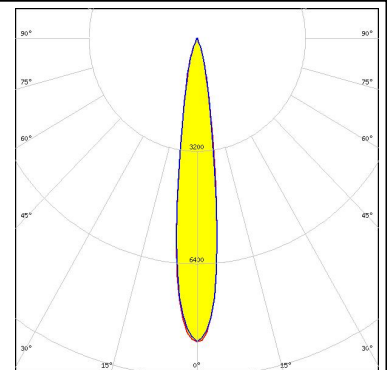

GENERAL INFORMATION:

NOTE: The typical beam angle will be changed by different color, chip size and chip position tolerance. The typical total beam angle is the full angle measured where the luminous intensity is half of the peak value.

MATERIALS:

As part of our continuous research and improvement processes, and to ensure the best possible quality and availability of our products, LEDiL reserves the right to change material grades without notice.

PRODUCT DATA USER AGREEMENT AND DISCLAIMER:

The measured data in the provided downloadable LEDiL Product Datasheets and Mechanical 2D-Drawings is rounded and provided as reference for planning. LEDiL Oy's optical specifications have been verified by conducting performance testing of the products in accordance with the company's quality system. The reported data are averaged results of multiple measurements with typical variation. LEDiL Oy reserves the right to without prior notification make changes and improvements to its products.

LEDiL Oy assumes neither warranty, nor guarantee nor any other liability of any kind for the contents and correctness of the provided data. The provided data has been generated with highest diligence but the provided data may in reality not represent the complete possible variation range of all intrinsic parameters. Therefore, in certain cases a deviation from the provided data could occur.

LEDiL Oy reserves the right to undertake technical changes of its products without further notification which could lead to changes in the provided data. LEDiL Oy assumes no liability of any kind for the possible deviation from any provided data or any other damage resulting from the usage of the provided data.

The user agrees to this disclaimer and user agreement with the download or usage of the provided files.

LEDiL Oy

Joensuunkatu 13
FI-24240 SALO
Finland

LEDiL Inc.

228 West Page Street
Suite D
Sycamore IL 60178
USA

Local sales and technical support

[www.ledil.com/
where_to_buy](http://www.ledil.com/where_to_buy)

Shipping locations

Salo, Finland
Hong Kong, China

Distribution Partners

[www.ledil.com/
where_to_buy](http://www.ledil.com/where_to_buy)

Компания «Life Electronics» занимается поставками электронных компонентов импортного и отечественного производства от производителей и со складов крупных дистрибьюторов Европы, Америки и Азии.

С конца 2013 года компания активно расширяет линейку поставок компонентов по направлению коаксиальный кабель, кварцевые генераторы и конденсаторы (керамические, пленочные, электролитические), за счёт заключения дистрибьюторских договоров

Мы предлагаем:

- Конкурентоспособные цены и скидки постоянным клиентам.
- Специальные условия для постоянных клиентов.
- Подбор аналогов.
- Поставку компонентов в любых объемах, удовлетворяющих вашим потребностям.
- Приемлемые сроки поставки, возможна ускоренная поставка.
- Доставку товара в любую точку России и стран СНГ.
- Комплексную поставку.
- Работу по проектам и поставку образцов.
- Формирование склада под заказчика.
- Сертификаты соответствия на поставляемую продукцию (по желанию клиента).
- Тестирование поставляемой продукции.
- Поставку компонентов, требующих военную и космическую приемку.
- Входной контроль качества.
- Наличие сертификата ISO.

В составе нашей компании организован Конструкторский отдел, призванный помогать разработчикам, и инженерам.

Конструкторский отдел помогает осуществить:

- Регистрацию проекта у производителя компонентов.
- Техническую поддержку проекта.
- Защиту от снятия компонента с производства.
- Оценку стоимости проекта по компонентам.
- Изготовление тестовой платы монтаж и пусконаладочные работы.



Тел: +7 (812) 336 43 04 (многоканальный)

Email: org@lifeelectronics.ru