



■ Features :

- Various output configuration is selectable
- Built in active PFC, PF>0.95
- Universal AC input/ full range
- Remote Control on every individual output module
- Remote Sense on every single output module(MS-75,150,210,300,360)
- Remote margin / V-Program(MS-210/360)
- Built in parallel function(MS-210/300/360)
- Protections: Short circuit / Overload / Over voltage for all output modules
- Additional 12V/0.1A auxiliary output for remote control
- Cooling by built-in DC fan with fan alarm function
- 3 years warranty



Output Configuration Guide

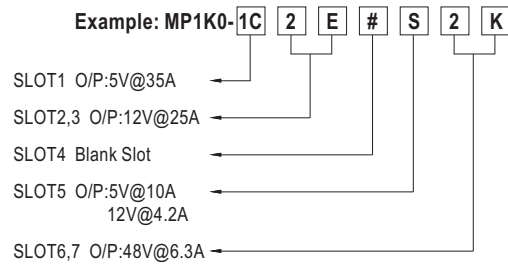
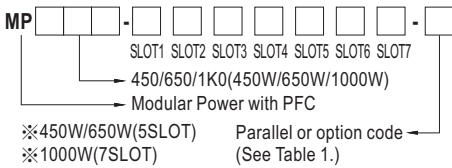

Single output(MS-150) 1 SLOT (150W max.)		Single output(MS-210) 1 SLOT (210W max.)		Single output(MS-300) 2 SLOT (300W max.)		Single output(MS-360) 2 SLOT (360W max.)		Single output(MS-75) 1 SLOT (75W max.)		Dual output(MD-100) 1 SLOT (100W max.)	
Voltage code	Voltage	Voltage code	Voltage	Voltage code	Voltage	Voltage code	Voltage	Voltage code	Voltage	Voltage code	Voltage
A	2V	1A	2V	2A	2V	3A	2V	L	3.3V	R	5V
B	3.3V	1B	3.3V	2B	3.3V	3B	3.3V	M	5V	S	5V
C	5V	1C	5V	2C	5V	3C	5V	N	12V	T	12V
D	7.5V	1D	7.5V	2D	7.5V	3D	7.5V	O	15V	U	15V
E	12V	1E	12V	2E	12V	3E	12V	P	24V	V	24V
F	15V	1F	15V	2F	15V	3F	15V	Q	48V	W	12V
G	18V	1G	18V	2G	18V	3G	18V			X	12V
H	24V	1H	24V	2H	24V	3H	24V				15V
I	27V	1I	27V	2I	27V	3I	27V				15V
J	33V	1J	33V	2J	33V	3J	33V				
K	48V	1K	48V	2K	48V	3K	48V				

SPECIFICATION

MODEL		PFC-450	PFC-650	PFC-1000
INPUT	VOLTAGE RANGE	85 ~ 264VAC 120 ~ 370VDC		
	FREQUENCY RANGE	47 ~ 63Hz		
	POWER FACTOR	PF>0.95/230VAC PF>0.98/115VAC at full load		
	EFFICIENCY Note.1	82.5% typ.	84% typ.	84% typ.
	AC CURRENT	6.3A/115VAC 3.2A/230VAC	9A/115VAC 4.5A/230VAC	13.5A/115VAC 6.7A/230VAC
	INRUSH CURRENT	25A/115VAC 40A/230VAC	30A/115VAC 50A/230VAC	20A/115VAC 40A/230VAC
LEAKAGE CURRENT		<1.5mA/240VAC		
OUTPUT	TOTAL OUTPUT POWER	450W max.	650W max.	1000W max.
PROTECTION	OVER TEMPERATURE	Shut down o/p voltage, recovers automatically after temperature goes down		
	FAN ALARM	Output shutdown when FAN is malfunction		
FUNCTION	REMOTE CONTROL	RC+/RC-: 0 ~ 0.8V or Short, Power ON RC+/RC-: 4 ~ 12V or Open, Power OFF		
	AUXILIARY POWER(AUX)	12V@0.1A(only for Remote ON/OFF Control)		
ENVIRONMENT	WORKING TEMP.	-20 ~ +70°C (Refer to "Derating Curve")		
	WORKING HUMIDITY	20 ~ 90% RH non-condensing		
	STORAGE TEMP., HUMIDITY	-40 ~ +85°C, 10 ~ 95% RH non-condensing		
	TEMP. COEFFICIENT	±0.03%/°C (0 ~ 50°C)		
VIBRATION		10 ~ 500Hz, 2G 10min./1cycle, 60min. each along X, Y, Z axes		
SAFETY & EMC (Note 5)	SAFETY STANDARDS	UL62368-1, TUV EN62368-1, EAC TP TC 004 approved		
	WITHSTAND VOLTAGE	I/P-O/P:3KVAC I/P-FG:2KVAC O/P-FG:0.5KVAC		
	ISOLATION RESISTANCE	I/P-O/P, I/P-FG, O/P-FG:100M Ohms / 500VDC / 25°C / 70% RH		
	EMC EMISSION	Compliance to EN55032 (CISPR32) Class B, EN61000-3-2,-3, EAC TP TC 020		
EMC IMMUNITY		Compliance to EN61000-4-2,3,4,5,6,8,11, EN55024, EN61000-6-1, EN61204-3, light industry level, criteria A, EAC TP TC 020		
OTHERS	DIMENSION	254*127*63.5mm (L*W*H)	278*127*63.5mm (L*W*H)	278*177.8*63.5mm (L*W*H)
	PACKING	1.8Kg(typ.); 6pcs / 11.8Kg / 1.25CUFT	2.16Kg(typ.); 6pcs / 14Kg / 1.34CUFT	3Kg(typ.); 6pcs / 19Kg / 1.74CUFT

SPECIFICATION

■ 1 SLOT Single output (150W) MS-150

OUTPUT (MS-150)	OUTPUT VOLTAGE CODE	MS-150A	MS-150B	MS-150C	MS-150D	MS-150E	MS-150F	MS-150G	MS-150H	MS-150I	MS-150J	MS-150K	
	DC VOLTAGE	2V	3.3V	5V	7.5V	12V	15V	18V	24V	27V	33V	48V	
	RATED CURRENT	25A	25A	25A	18A	13A	10A	8.5A	6.5A	5.8A	4.7A	3.2A	
	CURRENT RANGE	0 ~ 25A	0 ~ 25A	0 ~ 25A	0 ~ 18A	0 ~ 13A	0 ~ 10A	0 ~ 8.5A	0 ~ 6.5A	0 ~ 5.8A	0 ~ 4.7A	0 ~ 3.2A	
	PEAK LOAD <small>Note.4</small>	30A	30A	30A	20.7A	15A	11.5A	9.8A	7.5A	6.7A	5.4A	3.68A	
	RATED POWER	50W	82.5W	125W	135W	156W	150W	153W	156W	156.6W	155.1W	153.6W	
	RIPPLE & NOISE (max.) <small>Note.2</small>	50mVp-p	80mVp-p	80mVp-p	100mVp-p	150mVp-p	150mVp-p	150mVp-p	150mVp-p	150mVp-p	250mVp-p	250mVp-p	
	VOLTAGE ADJ. RANGE	1.6 ~ 2.6V	2.6 ~ 4V	4 ~ 6V	6 ~ 9V	9 ~ 13.2V	13.2 ~ 16.8V	16.8 ~ 20V	20 ~ 26.4V	25 ~ 31V	30 ~ 40V	40 ~ 53V	
	VOLTAGE TOLERANCE <small>Note.3</small>	±3.0%	±2.0%	±2.0%	±2.0%	±1.0%	±1.0%	±1.0%	±1.0%	±1.0%	±1.0%	±1.0%	
	LINE REGULATION	±0.5%	±0.5%	±0.5%	±0.5%	±0.3%	±0.3%	±0.3%	±0.2%	±0.2%	±0.2%	±0.2%	
	LOAD REGULATION	±2.0%	±1.0%	±1.0%	±1.0%	±0.5%	±0.5%	±0.5%	±0.5%	±0.5%	±0.5%	±0.5%	
	SETUP, RISE, HOLD UP TIME	1500ms, 50ms, 20ms at full load											
PROTECTION	OVERLOAD	121 ~ 150% rated output power				116 ~ 150% rated output power							
	OVER VOLTAGE	Protection type : Constant current limiting, recovers automatically after fault condition is removed											
FUNCTION	REMOTE INHIBIT CONTROL	RC+/RC-: 0 ~ 0.8V or OPEN, POWER ON						RC+/RC-: 4 ~ 12V POWER OFF					

■ 1 SLOT Single output (210W) MS-210

OUTPUT (MS-210)	OUTPUT VOLTAGE CODE	MS-210-1A	MS-210-1B	MS-210-1C	MS-210-1D	MS-210-1E	MS-210-1F	MS-210-1G	MS-210-1H	MS-210-1I	MS-210-1J	MS-210-1K	
	DC VOLTAGE	2V	3.3V	5V	7.5V	12V	15V	18V	24V	27V	33V	48V	
	RATED CURRENT	35A	35A	35A	28A	17.5A	14A	11.6A	8.75A	7.8A	6.4A	4.4A	
	CURRENT RANGE	0 ~ 35A	0 ~ 35A	0 ~ 35A	0 ~ 28A	0 ~ 17.5A	0 ~ 14A	0 ~ 11.6A	0 ~ 8.75A	0 ~ 7.8A	0 ~ 6.4A	0 ~ 4.4A	
	PEAK LOAD <small>Note.4</small>	38.5A	38.5A	38.5A	32.2A	20.1A	16.1A	13.4A	10.1A	9A	7.4A	5.1A	
	RATED POWER	70W	115.5W	175W	210W	210W	210W	208.8W	210W	210.6W	211.2W	211.2W	
	RIPPLE & NOISE (max.) <small>Note.2</small>	50mVp-p	80mVp-p	80mVp-p	100mVp-p	150mVp-p	150mVp-p	150mVp-p	150mVp-p	150mVp-p	250mVp-p	250mVp-p	
	VOLTAGE ADJ. RANGE	1.6 ~ 2.6V	2.6 ~ 4V	4 ~ 6V	6 ~ 9V	9 ~ 13.2V	13.2 ~ 16.8V	16.8 ~ 20V	20 ~ 26.4V	25 ~ 31V	30 ~ 40V	40 ~ 53V	
	VOLTAGE TOLERANCE <small>Note.3</small>	±3.0%	±2.0%	±2.0%	±2.0%	±1.0%	±1.0%	±1.0%	±1.0%	±1.0%	±1.0%	±1.0%	
	LINE REGULATION	±0.5%	±0.5%	±0.5%	±0.5%	±0.3%	±0.3%	±0.3%	±0.2%	±0.2%	±0.2%	±0.2%	
	LOAD REGULATION	±2.0%	±1.5%	±1.0%	±1.0%	±0.5%	±0.5%	±0.5%	±0.5%	±0.5%	±0.5%	±0.5%	
	SETUP, RISE, HOLD UP TIME	1500ms, 50ms, 20ms at full load											
PROTECTION	OVERLOAD	110 ~ 135% rated output power				116 ~ 150% rated output power							
	OVER VOLTAGE	Protection type : Constant current limiting, recovers automatically after fault condition is removed											
FUNCTION	REMOTE INHIBIT CONTROL	RC+/RC-: 0 ~ 0.8V or OPEN, POWER ON						RC+/RC-: 4 ~ 12V POWER OFF					

■ 2 SLOT Single output (300W) MS-300

OUTPUT (MS-300)	OUTPUT VOLTAGE CODE	MS-300-2A	MS-300-2B	MS-300-2C	MS-300-2D	MS-300-2E	MS-300-2F	MS-300-2G	MS-300-2H	MS-300-2I	MS-300-2J	MS-300-2K	
	DC VOLTAGE	2V	3.3V	5V	7.5V	12V	15V	18V	24V	27V	33V	48V	
	RATED CURRENT	50A	50A	50A	40A	25A	20A	16.7A	12.5A	11.2A	9.1A	6.3A	
	CURRENT RANGE	0 ~ 50A	0 ~ 50A	0 ~ 50A	0 ~ 40A	0 ~ 25A	0 ~ 20A	0 ~ 16.7A	0 ~ 12.5A	0 ~ 11.2A	0 ~ 9.1A	0 ~ 6.3A	
	PEAK LOAD <small>Note.4</small>	57.5A	57.5A	57.5A	46A	29A	23A	19.2A	14.4A	12.9A	10.5A	7.2A	
	RATED POWER	100W	165W	250W	300W	300W	300W	300.6W	300W	302.4W	300.3W	302.4W	
	RIPPLE & NOISE (max.) <small>Note.2</small>	80mVp-p	80mVp-p	80mVp-p	100mVp-p	150mVp-p	150mVp-p	150mVp-p	150mVp-p	200mVp-p	250mVp-p	300mVp-p	
	VOLTAGE ADJ. RANGE	1.6 ~ 2.6V	2.6 ~ 4V	4 ~ 6V	6 ~ 9V	9 ~ 13.2V	13.2 ~ 16.8V	16.8 ~ 20V	20 ~ 26.4V	25 ~ 31V	30 ~ 40V	40 ~ 53V	
	VOLTAGE TOLERANCE <small>Note.3</small>	±3.0%	±2.0%	±2.0%	±2.0%	±1.0%	±1.0%	±1.0%	±1.0%	±1.0%	±1.0%	±1.0%	
	LINE REGULATION	±0.5%	±0.5%	±0.5%	±0.5%	±0.3%	±0.3%	±0.3%	±0.2%	±0.2%	±0.2%	±0.2%	
	LOAD REGULATION	±2.0%	±1.0%	±1.0%	±1.0%	±0.5%	±0.5%	±0.5%	±1.0%	±1.0%	±1.0%	±1.0%	
	SETUP, RISE, HOLD UP TIME	1500ms, 50ms, 20ms at full load											
PROTECTION	OVERLOAD	116 ~ 150% rated output power											
	OVER VOLTAGE	Protection type : Constant current limiting, recovers automatically after fault condition is removed											
FUNCTION	REMOTE INHIBIT CONTROL	RC+/RC-: 0 ~ 0.8V or OPEN, POWER ON						RC+/RC-: 4 ~ 12V POWER OFF					

■ 2 SLOT Single output (360W) MS-360

OUTPUT (MS-360)	OUTPUT VOLTAGE CODE	MS-360-3A	MS-360-3B	MS-360-3C	MS-360-3D	MS-360-3E	MS-360-3F	MS-360-3G	MS-360-3H	MS-360-3I	MS-360-3J	MS-360-3K	
	DC VOLTAGE	2V	3.3V	5V	7.5V	12V	15V	18V	24V	27V	33V	48V	
	RATED CURRENT	60A	60A	60A	48A	30A	24A	20A	15A	13.4A	11A	7.5A	
	CURRENT RANGE	0 ~ 60A	0 ~ 60A	0 ~ 60A	0 ~ 48A	0 ~ 30A	0 ~ 24A	0 ~ 20A	0 ~ 15A	0 ~ 13.4A	0 ~ 11A	0 ~ 7.5A	
	PEAK LOAD <small>Note.4</small>	69A	69A	69A	55.2A	34.5A	27.6A	23A	17.3A	15.5A	12.7A	8.7A	
	RATED POWER	120W	198W	300W	360W	360W	360W	360W	360W	361.8W	363W	360W	
	RIPPLE & NOISE (max.) <small>Note.2</small>	80mVp-p	100mVp-p	100mVp-p	100mVp-p	150mVp-p	150mVp-p	150mVp-p	150mVp-p	200mVp-p	250mVp-p	300mVp-p	
	VOLTAGE ADJ. RANGE	1.6 ~ 2.6V	2.6 ~ 4V	4 ~ 6V	6 ~ 9V	9 ~ 13.2V	13.2 ~ 16.8V	16.8 ~ 20V	20 ~ 26.4V	25 ~ 31V	30 ~ 40V	40 ~ 53V	
	VOLTAGE TOLERANCE <small>Note.3</small>	±3.0%	±2.0%	±2.0%	±2.0%	±1.0%	±1.0%	±1.0%	±1.0%	±1.0%	±1.0%	±1.0%	
	LINE REGULATION	±0.5%	±0.5%	±0.5%	±0.5%	±0.3%	±0.3%	±0.3%	±0.2%	±0.2%	±0.2%	±0.2%	
	LOAD REGULATION	±2.0%	±1.5%	±1.0%	±1.0%	±0.5%	±0.5%	±0.5%	±1.0%	±1.0%	±1.0%	±1.0%	
	SETUP, RISE, HOLD UP TIME	1500ms, 50ms, 20ms at full load											
PROTECTION	OVERLOAD	116 ~ 150% rated output power											
	OVER VOLTAGE	Protection type : Constant current limiting, recovers automatically after fault condition is removed											
FUNCTION	REMOTE INHIBIT CONTROL	RC+/RC-: 0 ~ 0.8V or OPEN, POWER ON						RC+/RC-: 4 ~ 12V POWER OFF					

SPECIFICATION

■ 1 SLOT Single output (75W) MS-75

OUTPUT (MS-75)	OUTPUT VOLTAGE CODE	MS-75L	MS-75M	MS-75N	MS-75O	MS-75P	MS-75Q
	DC VOLTAGE	3.3V	5V	12V	15V	24V	48V
	RATED CURRENT	15A	15A	6.3A	5A	3.2A	1.6A
	CURRENT RANGE	0 ~ 15A	0 ~ 15A	0 ~ 6.3A	0 ~ 5A	0 ~ 3.2A	0 ~ 1.6A
	PEAK LOAD <small>Note.4</small>	17.3A	17.3A	7.3A	5.8A	3.7A	1.8A
	RATED POWER	49.5W	75W	75.6W	75W	76.8W	76.8W
	RIPPLE & NOISE (max.) <small>Note.2</small>	80mVp-p	80mVp-p	150mVp-p	150mVp-p	150mVp-p	250mVp-p
	VOLTAGE ADJ. RANGE	2.6 ~ 4V	4 ~ 6V	9 ~ 13.2V	13.2 ~ 16.8V	20 ~ 26.4V	40 ~ 53V
	VOLTAGE TOLERANCE <small>Note.3</small>	±2.0%	±2.0%	±1.0%	±1.0%	±1.0%	±1.0%
	LINE REGULATION	±0.5%	±0.5%	±0.3%	±0.3%	±0.2%	±0.2%
	LOAD REGULATION	±1.0%	±1.0%	±0.5%	±0.5%	±0.5%	±0.5%
SETUP, RISE, HOLD UP TIME	1500ms, 50ms, 20ms at full load						
PROTECTION	OVERLOAD	116 ~ 150% rated output power Protection type : Constant current limiting, recovers automatically after fault condition is removed					
	OVER VOLTAGE	4.1 ~ 5V	6.1 ~ 7.5V	13.3 ~ 18V	16.9 ~ 22V	26.5 ~ 35V	53.1 ~ 60V
FUNCTION	REMOTE INHIBIT CONTROL	RC+/RC-: 0 ~ 0.8V or OPEN, POWER ON RC+/RC-: 4 ~ 12V POWER OFF					

■ 1 SLOT Isolated Dual output (100W) MD-100

OUTPUT (MD-100)	OUTPUT VOLTAGE CODE	MD-100R		MD-100S		MD-100T		MD-100U		MD-100V		MD-100W		MD-100X			
	DC VOLTAGE	5V	5V	5V	12V	5V	15V	24V	5V	24V	12V	12V	12V	12V	15V	15V	
	RATED CURRENT	10A	8A	10A	4.2A	10A	3.4A	2.5A	8A	2.5A	3.4A	5A	3.4A	4A	2.7A	2.7A	
	CURRENT RANGE	2 ~ 10A	0 ~ 8A	2 ~ 10A	0 ~ 5.8A	2 ~ 10A	0 ~ 4.7A	0.5 ~ 3A	0 ~ 10A	0.6 ~ 3A	0 ~ 4.7A	1 ~ 5A	0 ~ 5.8A	1 ~ 4.7A	0 ~ 4.7A	0 ~ 4.7A	
	RATED POWER <small>Note.6</small>	90W		100.4W		101W		100W		100.8W		100.8W		100.5W		100.5W	
	RIPPLE & NOISE (max.) <small>Note.2</small>	100mVp-p	100mVp-p	100mVp-p	150mVp-p	100mVp-p	150mVp-p	200mVp-p	100mVp-p	240mVp-p	120mVp-p	120mVp-p	120mVp-p	120mVp-p	150mVp-p	150mVp-p	
	VOLTAGE ADJ. RANGE	4.75 ~ 5.5V	4.75 ~ 5.5V	4.75 ~ 5.5V	11.4 ~ 13.2V	4.75 ~ 5.5V	14.2 ~ 16.5V	22.8 ~ 26.4V	4.75 ~ 5.5V	22.8 ~ 26.4V	11.4 ~ 13.2V	11.4 ~ 13.2V	11.4 ~ 13.2V	11.4 ~ 13.2V	14.2 ~ 16.5V	14.2 ~ 16.5V	
	VOLTAGE TOLERANCE <small>Note.3</small>	±3.0%	±3.0%	±3.0%	±3.0%	±3.0%	±3.0%	±3.0%	±3.0%	±2.0%	±3.0%	±2.0%	±3.0%	±2.0%	±3.0%	±3.0%	
	LINE REGULATION	±1.0%	±1.0%	±1.0%	±1.0%	±1.0%	±1.0%	±1.0%	±1.0%	±0.5%	±1.0%	±0.5%	±1.0%	±0.5%	±1.0%	±1.0%	
	LOAD REGULATION	±2.0%	±2.0%	±2.0%	±2.0%	±2.0%	±2.0%	±2.0%	±2.0%	±1.0%	±2.0%	±1.0%	±2.0%	±1.0%	±2.0%	±2.0%	
	SETUP, RISE, HOLD UP TIME	1500ms, 50ms, 20ms at full load															
PROTECTION	OVERLOAD	105 ~ 150% rated output power Protection type : Shut down o/p voltage, re-power on to recover															
	OVER VOLTAGE	5.6 ~ 7.2V	5.6 ~ 7.2V	5.6 ~ 7.2V	13.3 ~ 17V	5.6 ~ 7.2V	16.6 ~ 22V	26.5 ~ 34V	5.6 ~ 7.2V	26.5 ~ 34V	13.3 ~ 17V	13.3 ~ 17V	13.3 ~ 17V	13.3 ~ 17V	16.6 ~ 22V	16.6 ~ 22V	
FUNCTION	REMOTE INHIBIT CONTROL	RC+/RC-: 0 ~ 0.8V or OPEN, POWER ON RC+/RC-: 4 ~ 12V POWER OFF															
NOTE	<p>1. MP450:The value changed by installing different output modules. The efficiency in specification means output modules are composed by following modules. 5V(Voltage code C)*1, 12V(Voltage code E)*1, 24V(Voltage code H)*1, 5V(Voltage code M)*1.</p> <p>MP650:The value changed by installing different output modules. The efficiency in specification means output modules are composed by following modules. 5V(Voltage code C)*2, 12V(Voltage code E)*1, 24V(Voltage code H)*2.</p> <p>MP1K0:The value changed by installing different output modules. The efficiency in specification means output modules are composed by following modules. 5V(Voltage code C)*2, 12V(Voltage code E)*2, 24V(Voltage code H)*3.</p> <p>The hold-up time of above combination is 20ms(typ.)</p> <p>2. Ripple & noise are measured at 20MHz of bandwidth by using a 12" twisted pair-wire terminated with a 0.1uf & 47uf parallel capacitor.</p> <p>3. Tolerance : includes set up tolerance, line regulation and load regulation.</p> <p>4. 35% Duty cycle maximum within every 10 seconds. Average output power should not exceed the rated power.</p> <p>5. The power supply is considered a component which will be installed into a final equipment. All the EMC tests are been executed by mounting the unit on a 720mm*360mm metal plate with 1mm of thickness. The final equipment must be re-confirmed that it still meets EMC directives. For guidance on how to perform these EMC tests, please refer to "EMI testing of component power supplies." (as available on http://www.meanwell.com)</p> <p>6. If the output voltage adjust to higher level, the rated current should be derated to meet the total rated power for both outputs(For MD-100 only).</p> <p>7.The ambient temperature derating of 3.5°C/1000m with fanless models and of 5°C/1000m with fan models for operating altitude higher than 2000m(6500ft).</p>																

Table 1. Parallel code(For MS-210、MS-300、MS-360 only)

Model	Code	SLOT1	SLOT2	SLOT3	SLOT4	SLOT5	SLOT6	SLOT7
MS-300/360	X						----	----
	1	○			○		----	----
	2			○	-----	○	----	----
	3				○		○	
	4					○	-----	○
	5	○			○	-----	○	
MS-210	7	○	○					
	8	○	○	○	○			
	9	○	○	○	○	○		

※Code X,1,2,7,8,9 for MP450, MP650

※Code X,1,2,3,4,5,6,7,8,9 for MP1K0

※Maximum number of units for parallel function : 5 for MS-210, 3 for MS-300/360

■ Mechanical Specification

Unit:mm

MP450

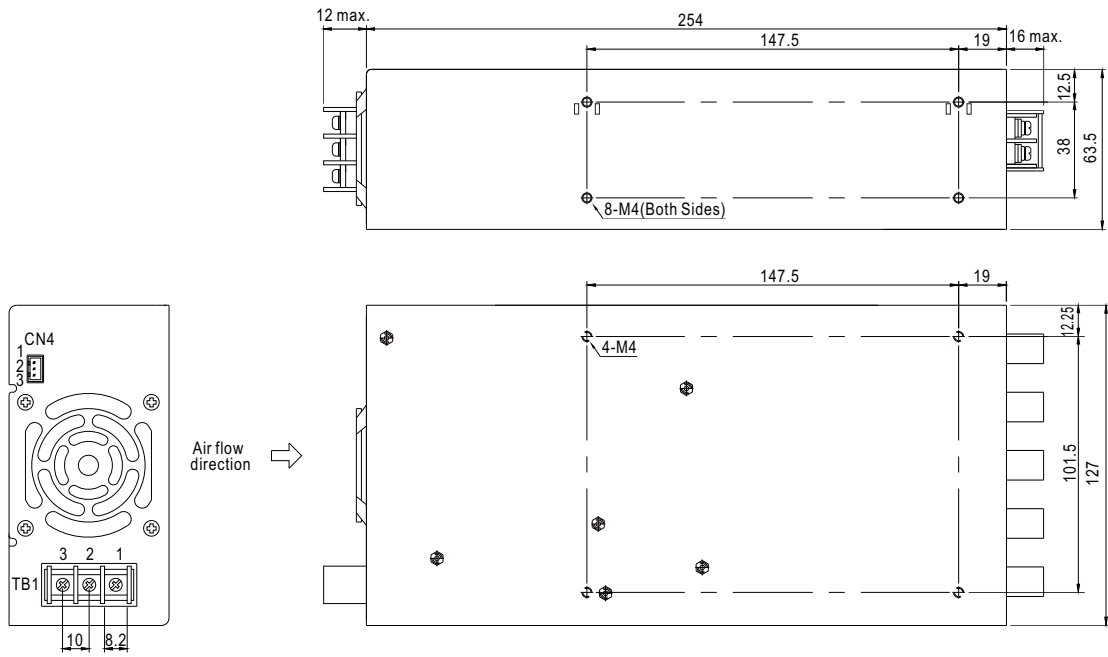

MP650

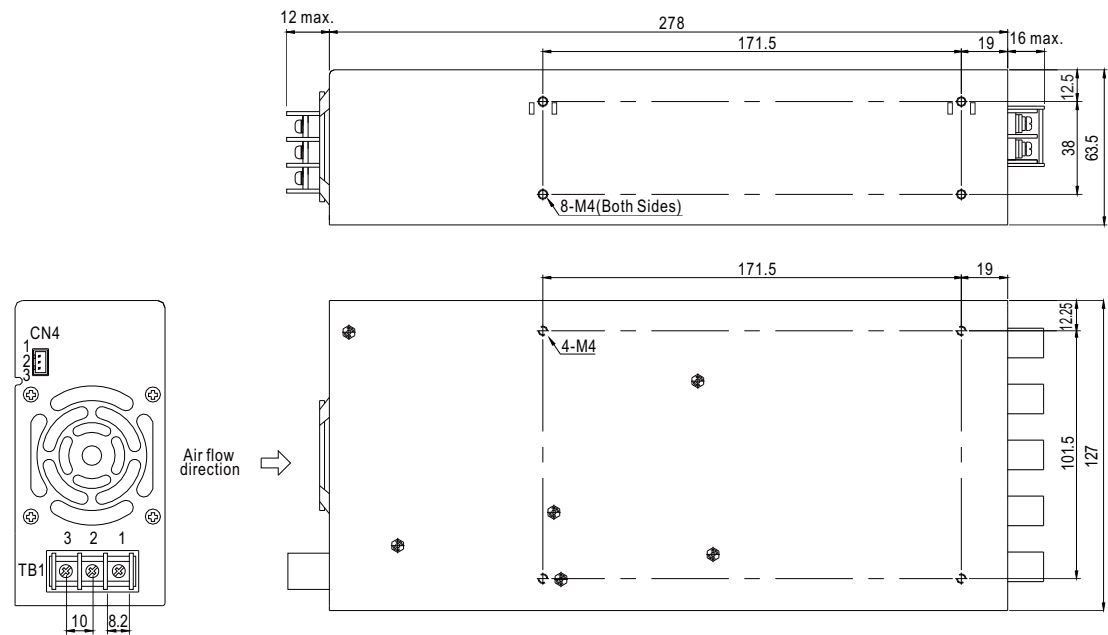

■ Mechanical Specification

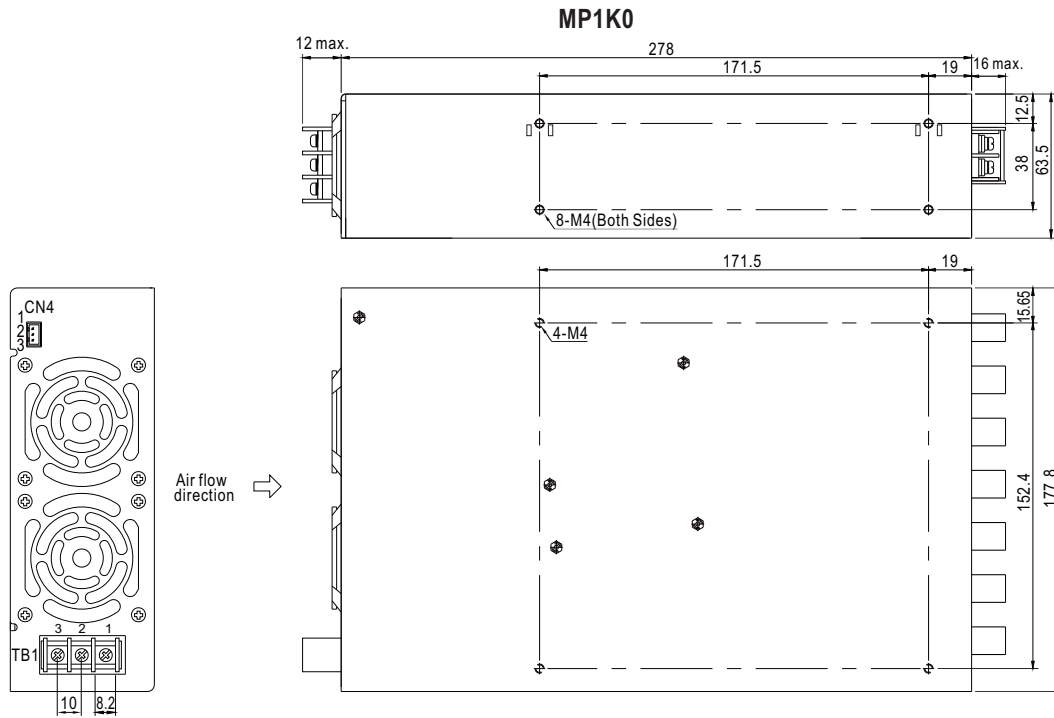

TB1(PFC-450/650/1K0)

Pin No.	Assignment
1	AC/L
2	AC/N
3	FG \perp

CN4(PFC-450/650/1K0) : JST B3B-XH or equivalent

Pin No.	Assignment	Mating Housing	Terminal
1	+RC: +Remote ON/OFF	JST XHP or equivalent	JST SXH-001T-P0.6 or equivalent
2	-RC: -Remote ON/OFF		
3	VCC: 12V/0.1A auxiliary output		

■ Mechanism of Output Modules

©MS-75

Unit:mm

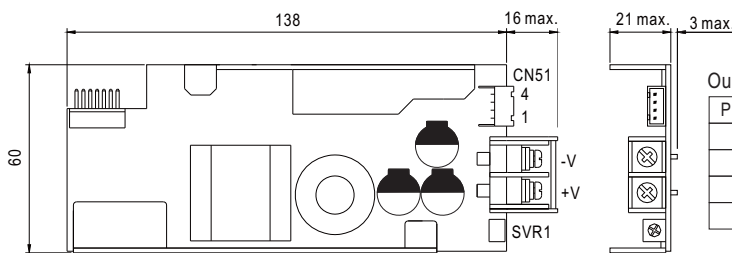

Output Connector(CN51) : JST B4B-XH or equivalent

Pin No.	Assignment	Mating Housing	Terminal
1	+S: +Remote sense	JST XHP or equivalent	JST SXH-001T-P0.6 or equivalent
2	-S: -Remote sense		
3	+RC: +Remote ON/OFF		
4	-RC: -Remote ON/OFF		

©MS-150

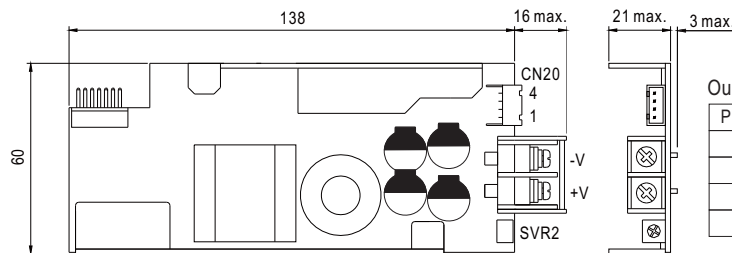

Output Connector(CN20) : JST B4B-XH or equivalent

Pin No.	Assignment	Mating Housing	Terminal
1	+S: +Remote sense	JST XHP or equivalent	JST SXH-001T-P0.6 or equivalent
2	-S: -Remote sense		
3	+RC: +Remote ON/OFF		
4	-RC: -Remote ON/OFF		

■ Mechanism of Output Modules

©MS-210

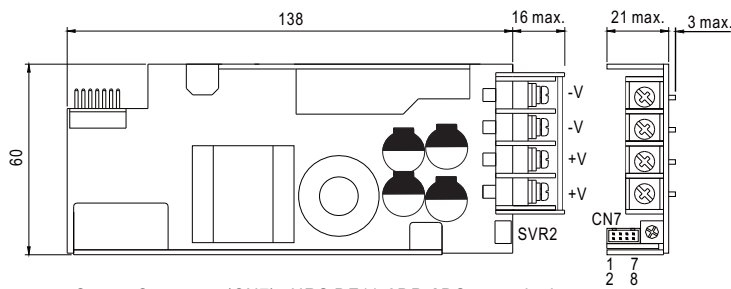

Output Connector(CN7) : HRS DF11-8DP-2DS or equivalent

Pin No.	Assignment	Pin No.	Assignment	Mating Housing	Terminal
1	+S: +Remote sense	5	CS: Current sharing	HRS DF11-8DS or equivalent	DRS DF11-**SC or equivalent
2	-S: -Remote sense	6	G: GND		
3	+RC: +Remote ON/OFF	7	ML: Remote margin low control		
4	-RC: -Remote ON/OFF	8	M: Remote margin control		

- NOTE: 1.The voltage difference among each output should be minimized that less than 2% is required.
 2.The total output current must not exceed the value determined by the following equation.
 (Output current at parallel operation) = (The rated current per unit) × (Number of unit) × 0.9

©MS-300

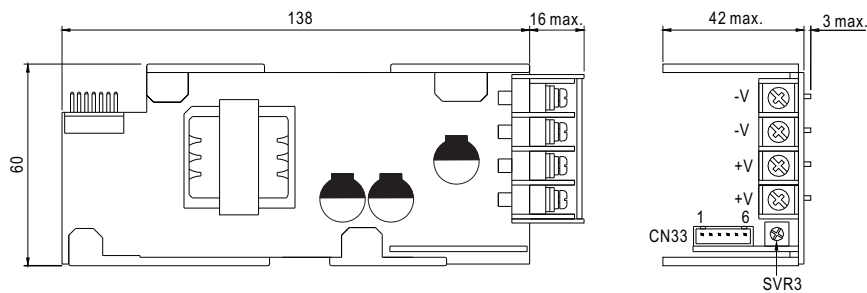

Output Connector(CN33) : JST B6B-XH or equivalent

Pin No.	Assignment	Mating Housing	Terminal
1	+S: +Remote sense	JST XHP or equivalent	JST SXH-001T-P0.6 or equivalent
2	-S: -Remote sense		
3	+RC: +Remote ON/OFF		
4	-RC: -Remote ON/OFF		
5	CS: Current sharing		
6	G: GND		

- NOTE: 1.The voltage difference among each output should be minimized that less than 2% is required.
 2.The total output current must not exceed the value determined by the following equation.
 (Output current at parallel operation) = (The rated current per unit) × (Number of unit) × 0.9

©MS-360

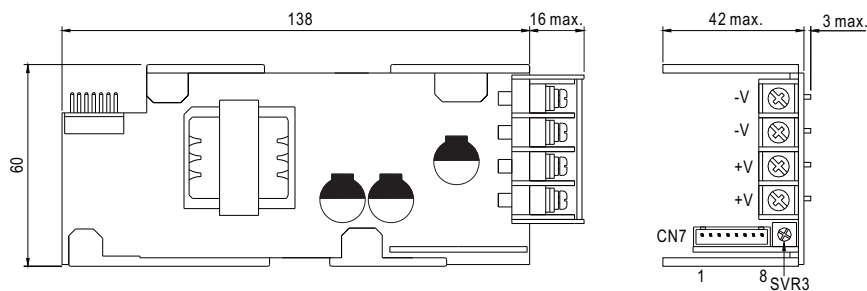

Output Connector(CN7) : JST B8B-XH or equivalent

Pin No.	Assignment	Pin No.	Assignment	Mating Housing	Terminal
1	+S: +Remote sense	5	CS: Current sharing	JST XHP or equivalent	JST SXH-001T-P0.6 or equivalent
2	-S: -Remote sense	6	G: GND		
3	+RC: +Remote ON/OFF	7	ML: Remote margin low control		
4	-RC: -Remote ON/OFF	8	M: Remote margin control		

- NOTE: 1.The voltage difference among each output should be minimized that less than 2% is required.
 2.The total output current must not exceed the value determined by the following equation.
 (Output current at parallel operation) = (The rated current per unit) × (Number of unit) × 0.9

■ Mechanism of Output Modules

©MD-100

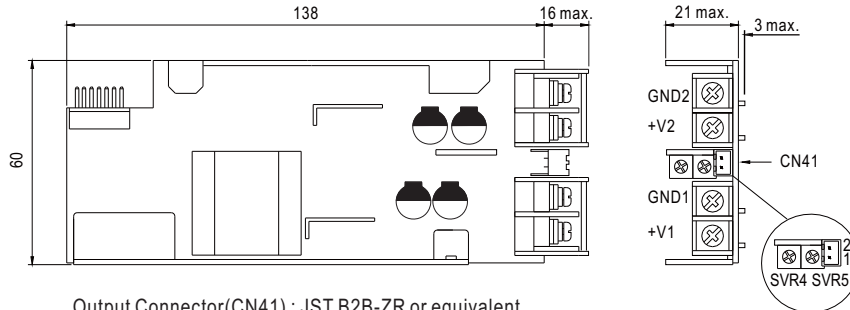

Output Connector(CN41) : JST B2B-ZR or equivalent

Pin No.	Assignment	Mating Housing	Terminal
1	+RC	JST ZHR-2 or equivalent	JST SZH-002T-P0.5 or equivalent
2	-RC		

- NOTE: 1.Remote ON/OFF of CN4 turn ON/OFF the entire power system
 2.Remote ON/OFF of CN20,CN33,CN41,CN51 turn ON/OFF the individual output module
 3.SVR1~5: DC output voltage adjustment(SVR4 for CH2 of MD-100,SVR5 for CH1 of MD-100)

■ Derating Curve

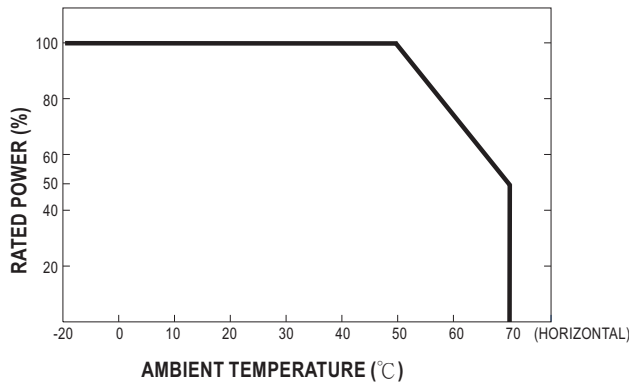

■ Static Characteristics

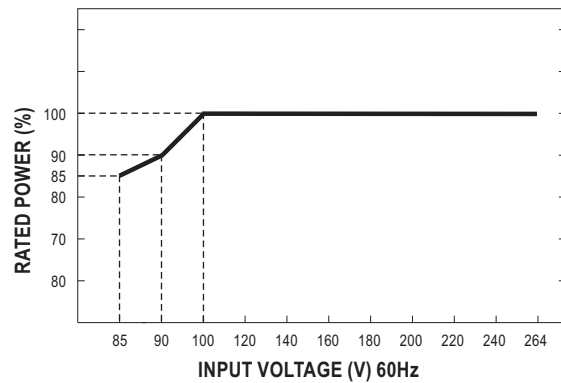

■ Remote Margin / V-Program

Remote Margin / V-Program is available for MS-210 and MS-360 to fine tune the output voltage. Hereunder is the instruction, assuming no voltage adjustment is applied via the built-in potentiometer.

- (1)When the function is not required, please have pin CN7-8 (refer to Mechanism of Output Modules) open, and the output voltage will present the nominal voltage.
- (2)Connecting pin CN7-8 with CN7-6 (or CN7-7) will tune the output voltage up (if CN7-7, down) by 5% of the nominal voltage.
- (3)Applying an additional 100K Ω potentiometer across CN7-6 and CN7-7 (referring to Figure 1) will enable the adjustment in between -5% and +5% (EX: -3%, +2.5%, and etc.)

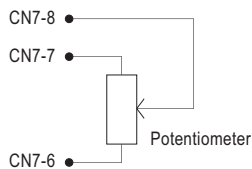

Figure 1

(Please refer to Mechanism of Output Modules)

Компания «Life Electronics» занимается поставками электронных компонентов импортного и отечественного производства от производителей и со складов крупных дистрибьюторов Европы, Америки и Азии.

С конца 2013 года компания активно расширяет линейку поставок компонентов по направлению коаксиальный кабель, кварцевые генераторы и конденсаторы (керамические, пленочные, электролитические), за счёт заключения дистрибьюторских договоров

Мы предлагаем:

- Конкурентоспособные цены и скидки постоянным клиентам.
- Специальные условия для постоянных клиентов.
- Подбор аналогов.
- Поставку компонентов в любых объемах, удовлетворяющих вашим потребностям.
- Приемлемые сроки поставки, возможна ускоренная поставка.
- Доставку товара в любую точку России и стран СНГ.
- Комплексную поставку.
- Работу по проектам и поставку образцов.
- Формирование склада под заказчика.
- Сертификаты соответствия на поставляемую продукцию (по желанию клиента).
- Тестирование поставляемой продукции.
- Поставку компонентов, требующих военную и космическую приемку.
- Входной контроль качества.
- Наличие сертификата ISO.

В составе нашей компании организован Конструкторский отдел, призванный помогать разработчикам, и инженерам.

Конструкторский отдел помогает осуществить:

- Регистрацию проекта у производителя компонентов.
- Техническую поддержку проекта.
- Защиту от снятия компонента с производства.
- Оценку стоимости проекта по компонентам.
- Изготовление тестовой платы монтаж и пусконаладочные работы.



Тел: +7 (812) 336 43 04 (многоканальный)
Email: org@lifeelectronics.ru